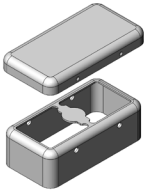
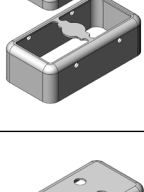
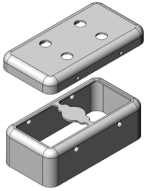
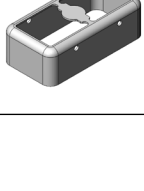
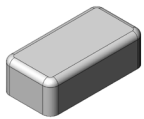

MS220-40*

DRAWN EMI/RFI SHIELD DATA-SHEET

*OPTIONAL SHIELD CONFIGURATIONS

| MS SHIELD | MS SET PN. | MS ITEM PN. | DESCRIPTION | RAW MATERIAL |
|---|--------------|---------------|-----------------------------------|-----------------|
|  | MS220-40 | MS220-40C | TWO-PIECE SHIELD COVER | TIN STEEL* |
| | | MS220-40F | TWO-PIECE SHIELD FRAME | |
|  | MS220-40-NS | MS220-40C-NS | TWO-PIECE SHIELD COVER | NICKEL SILVER** |
| | | MS220-40F-NS | TWO-PIECE SHIELD FRAME | |
|  | MS220-40P | MS220-40CP | TWO-PIECE SHIELD COVER PERFORATED | TIN STEEL* |
| | | MS220-40F | TWO-PIECE SHIELD FRAME | |
|  | MS220-40P-NS | MS220-40CP-NS | TWO-PIECE SHIELD COVER PERFORATED | NICKEL SILVER** |
| | | MS220-40F-NS | TWO-PIECE SHIELD FRAME | |
|  | | MS220-40S | ONE-PIECE SHIELD | TIN STEEL* |
| | | MS220-40S-NS | ONE-PIECE SHIELD | NICKEL SILVER** |

* TIN-PLATED STEEL: CRS ELECTROLYTIC TINPLATE

** NICKEL SILVER: UNS C77000 / UNS C73500



MS PN:

DESCRIPTION:

MATERIAL:

© MASACH TECH LTD.
22 HAGANAN, MODIIN 7169513 ISRAEL
T: (+972) 8-9754681 / F: (+972) 8-9754682
info@masach.com / www.masach.com

SHIELD TYPE:

SEAMLESS PROTECTIVE EMI/RFI CAGE

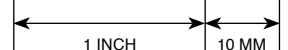

MMGS / PRINT 1:1 / A4

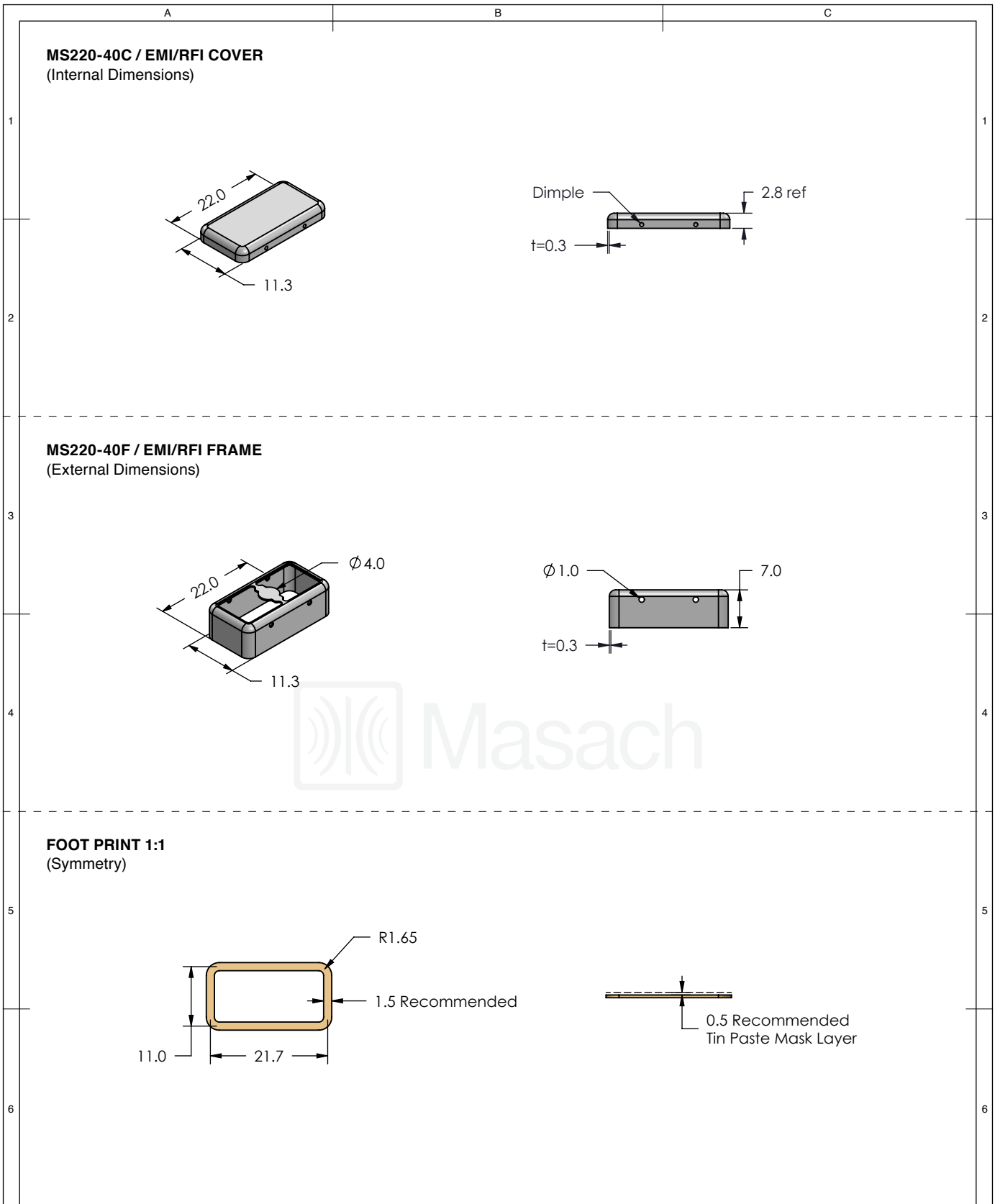

| | | | |
|---|---|-------------------------------|-----------------------------|
| | MS SET PN: | DESCRIPTION: | MATERIAL: |
| | MS220-40 | TWO-PIECE EM/RF SHIELD | TIN PLATED STEEL (1) |
| NOTE: (1) CRS ELECTROLYTIC TINPLATE (2) GENERAL TOLERANCE (+/-) 0.2MM | | | |
| © MASACH TECH LTD. 22 HAGANAN, MODIIN 7169513 ISRAEL T: (+972) 8-9754681 / F: (+972) 8-9754682 info@masach.com / www.masach.com | SHIELD TYPE: | | |
| | SEAMLESS PROTECTIVE EMI/RFI CAGE | | MMGS / PRINT 1:1 / A4 |

This product has been designed and manufactured by © Masach Tech Ltd. The use of this product in any type of electronic device or application is not under Masach Tech Ltd. liability.

MS220-40C-NS / EMI/RFI COVER
(Internal Dimensions)

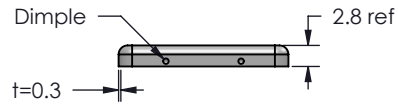
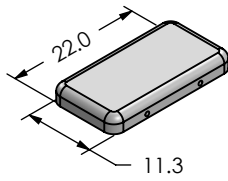

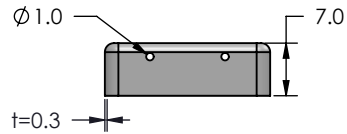
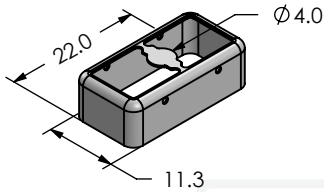

MS220-40F-NS / EMI/RFI FRAME
(External Dimensions)

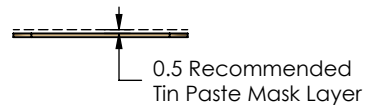
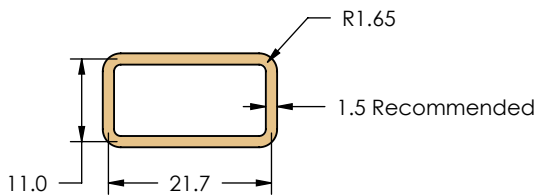

FOOT PRINT 1:1
(Symmetry)

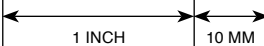

| | | | |
|---|---|---|---|
|  | MS SET PN: | DESCRIPTION: | MATERIAL: |
| | MS220-40-NS | TWO-PIECE EM/RF SHIELD | NICKEL SILVER (1) |
| NOTE: (1) UNS C77000 / UNS C73500 (2) GENERAL TOLERANCE (+/-) 0.2MM | | | |
| © MASACH TECH LTD. 22 HAGANAN, MODIIN 7169513 ISRAEL T: (+972) 8-9754681 / F: (+972) 8-9754682 info@masach.com / www.masach.com | SHIELD TYPE: |   |  |
| | SEAMLESS PROTECTIVE EMI/RFI CAGE | | MMGS / PRINT 1:1 / A4 |

This product has been designed and manufactured by © Masach Tech Ltd. The use of this product in any type of electronic device or application is not under Masach Tech Ltd. liability.

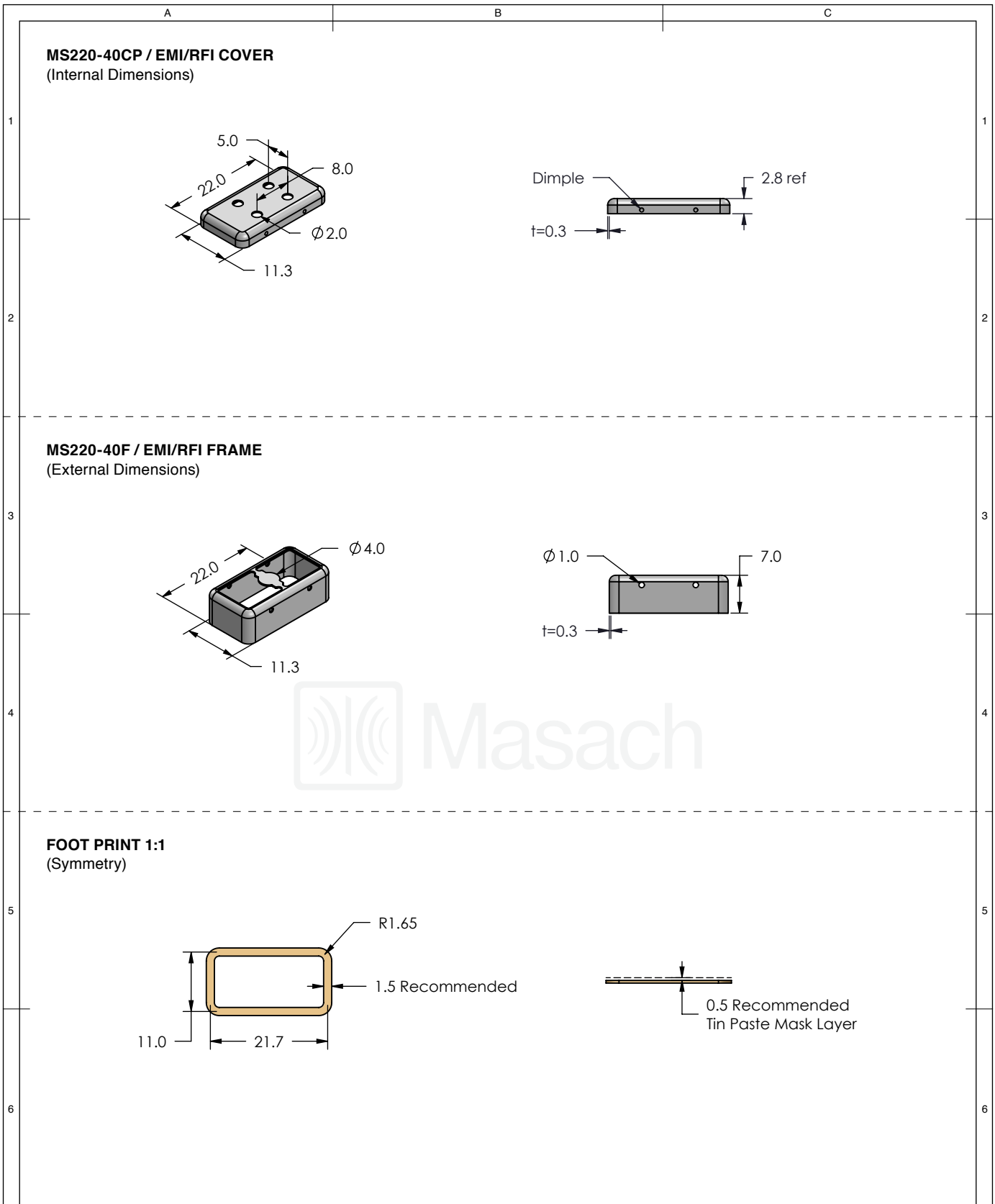

| | | | |
|---|---|-------------------------------|-----------------------------|
| | MS SET PN: | DESCRIPTION: | MATERIAL: |
| | MS220-40P | TWO-PIECE EM/RF SHIELD | TIN PLATED STEEL (1) |
| NOTE: (1) CRS ELECTROLYTIC TINPLATE (2) GENERAL TOLERANCE (+/-) 0.2MM | | | |
| © MASACH TECH LTD. 22 HAGANAN, MODIIN 7169513 ISRAEL T: (+972) 8-9754681 / F: (+972) 8-9754682 info@masach.com / www.masach.com | SHIELD TYPE: | | |
| | SEAMLESS PROTECTIVE EMI/RFI CAGE | | MMGS / PRINT 1:1 / A4 |

This product has been designed and manufactured by © Masach Tech Ltd. The use of this product in any type of electronic device or application is not under Masach Tech Ltd. liability.

MS220-40CP-NS / EMI/RFI COVER
(Internal Dimensions)

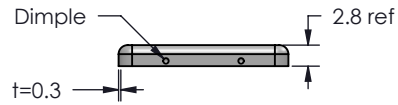
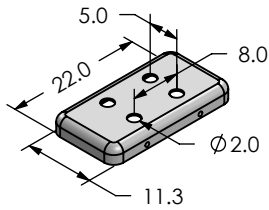

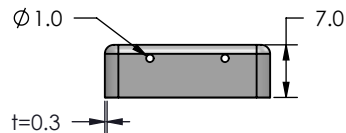
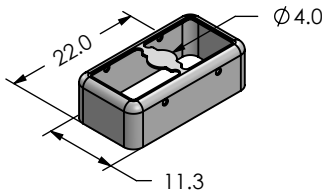

MS220-40F-NS / EMI/RFI FRAME
(External Dimensions)

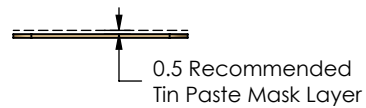
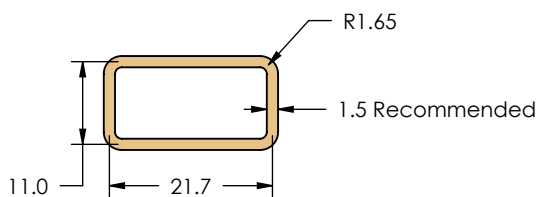

FOOT PRINT 1:1
(Symmetry)

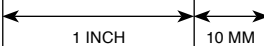

| | | | |
|---|---|---|---|
|  | MS SET PN: | DESCRIPTION: | MATERIAL: |
| | MS220-40P-NS | TWO-PIECE EM/RF SHIELD | NICKEL SILVER (1) |
| NOTE: (1) UNS C77000 / UNS C73500 (2) GENERAL TOLERANCE (+/-) 0.2MM | | | |
| © MASACH TECH LTD. 22 HAGANAN, MODIIN 7169513 ISRAEL T: (+972) 8-9754681 / F: (+972) 8-9754682 info@masach.com / www.masach.com | SHIELD TYPE: |   |  |
| | SEAMLESS PROTECTIVE EMI/RFI CAGE | | MMGS / PRINT 1:1 / A4 |

This product has been designed and manufactured by © Masach Tech Ltd. The use of this product in any type of electronic device or application is not under Masach Tech Ltd. liability.

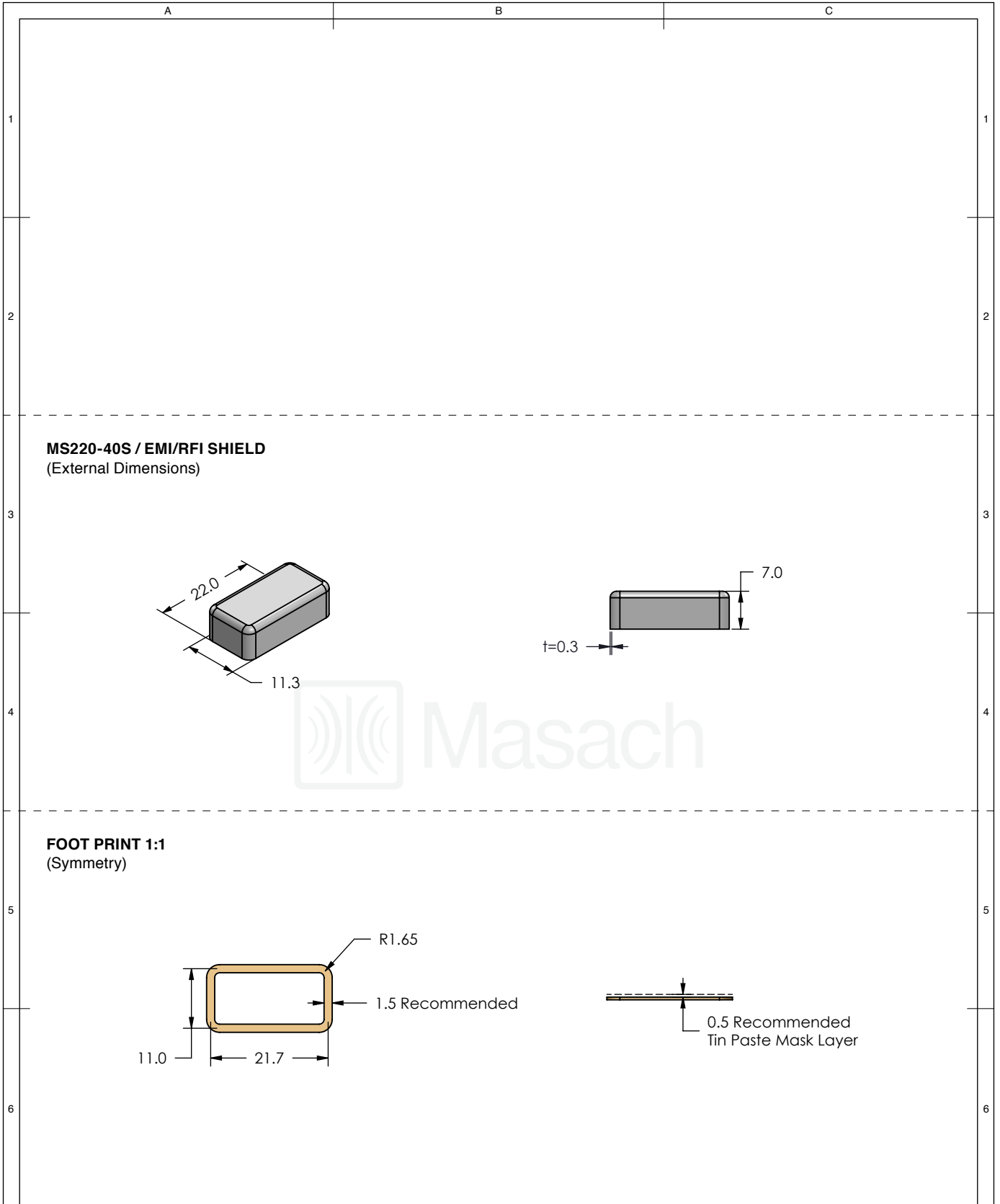

| | | | |
|---|---|--------------------------------|-----------------------------|
| | MS ITEM PN: | DESCRIPTION: | MATERIAL: |
| | MS220-40S | ONE-PIECE EMI/RF SHIELD | TIN PLATED STEEL (1) |
| NOTE: (1) CRS ELECTROLYTIC TINPLATE (2) GENERAL TOLERANCE (+/-) 0.2MM | | | |
| © MASACH TECH LTD. 22 HAGANAN, MODIIN 7169513 ISRAEL T: (+972) 8-9754681 / F: (+972) 8-9754682 info@masach.com / www.masach.com | SHIELD TYPE: | | |
| | SEAMLESS PROTECTIVE EMI/RFI CAGE | | MMGS / PRINT 1:1 / A4 |

This product has been designed and manufactured by © Masach Tech Ltd. The use of this product in any type of electronic device or application is not under Masach Tech Ltd. liability.

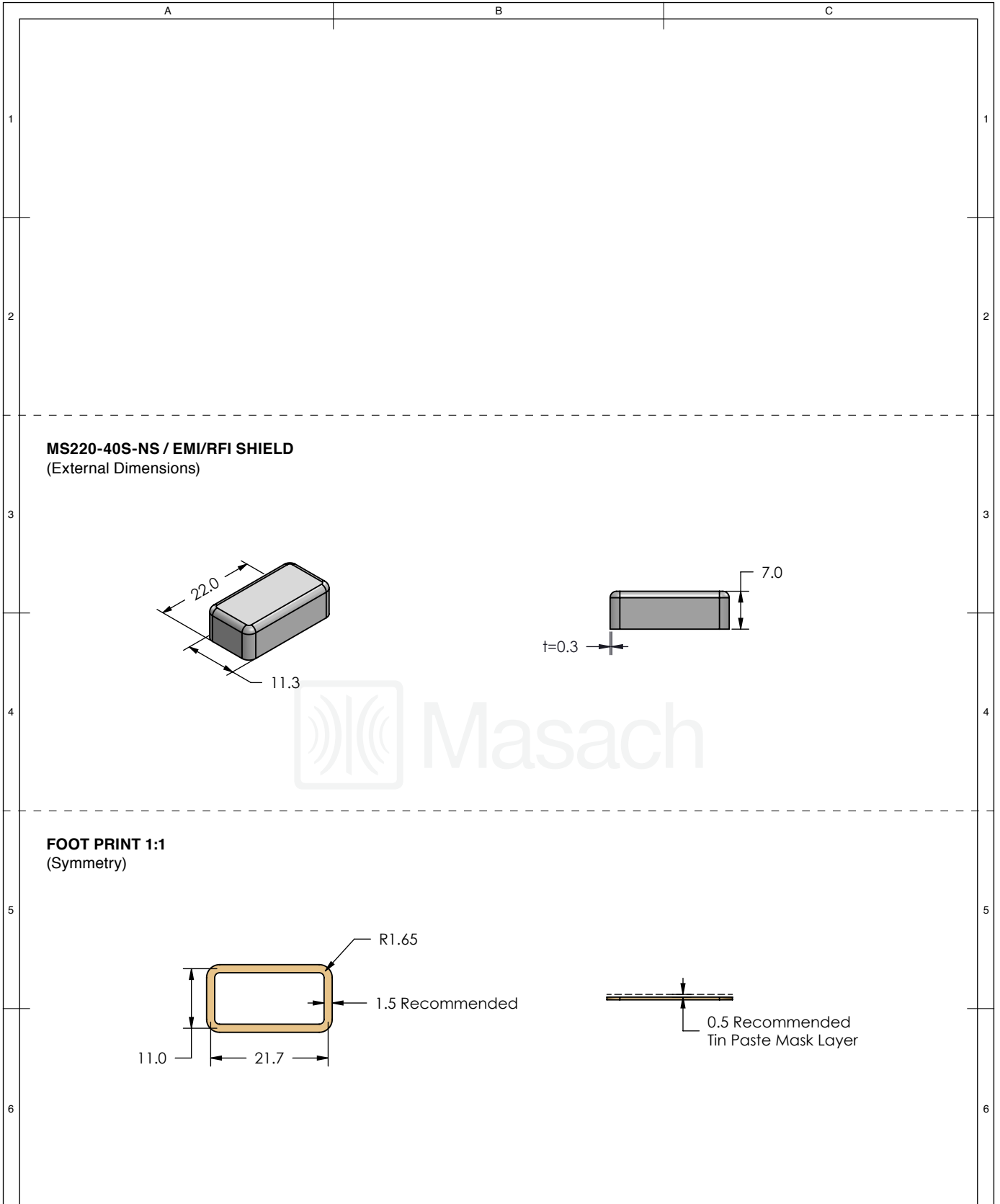

MS220-40S-NS / EMI/RFI SHIELD
(External Dimensions)

FOOT PRINT 1:1
(Symmetry)



| | | | |
|---|--|--------------------------------|--------------------------|
| | MS ITEM PN: | DESCRIPTION: | MATERIAL: |
| | MS220-40S-NS | ONE-PIECE EMI/RF SHIELD | NICKEL SILVER (1) |
| | NOTE: (1) UNS C77000 / UNS C73500 (2) GENERAL TOLERANCE (+/-) 0.2MM | | |
| © MASACH TECH LTD. 22 HAGANAN, MODIIN 7169513 ISRAEL T: (+972) 8-9754681 / F: (+972) 8-9754682 info@masach.com / www.masach.com | SHIELD TYPE: | | |
| | SEAMLESS PROTECTIVE EMI/RFI CAGE | | MMGS / PRINT 1:1 / A4 |

This product has been designed and manufactured by © Masach Tech Ltd. The use of this product in any type of electronic device or application is not under Masach Tech Ltd. liability.

A

B

C

MS220-40* / SMALL PACKING TRAY / SMD

* COMPATIBLE TO ALL SHIELD CONFIGURATIONS

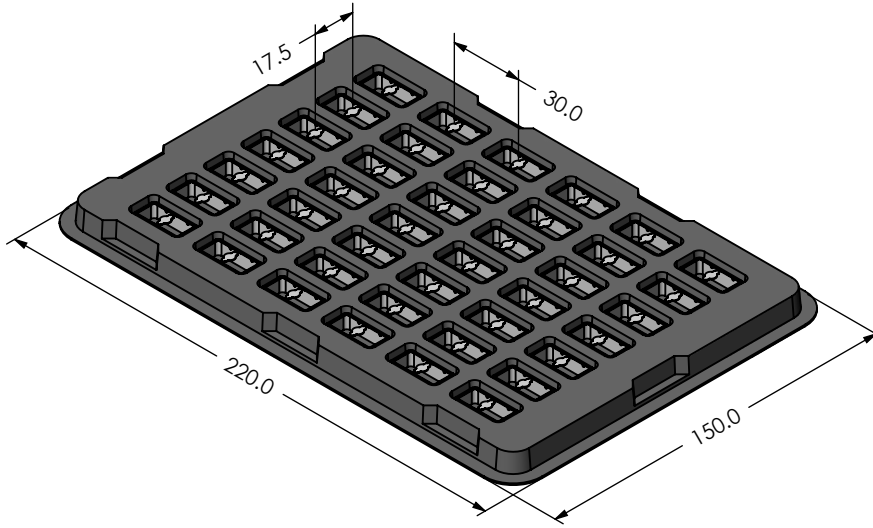

MS220-40* / LARGE PACKING TRAY / SMD

* COMPATIBLE TO ALL SHIELD CONFIGURATIONS

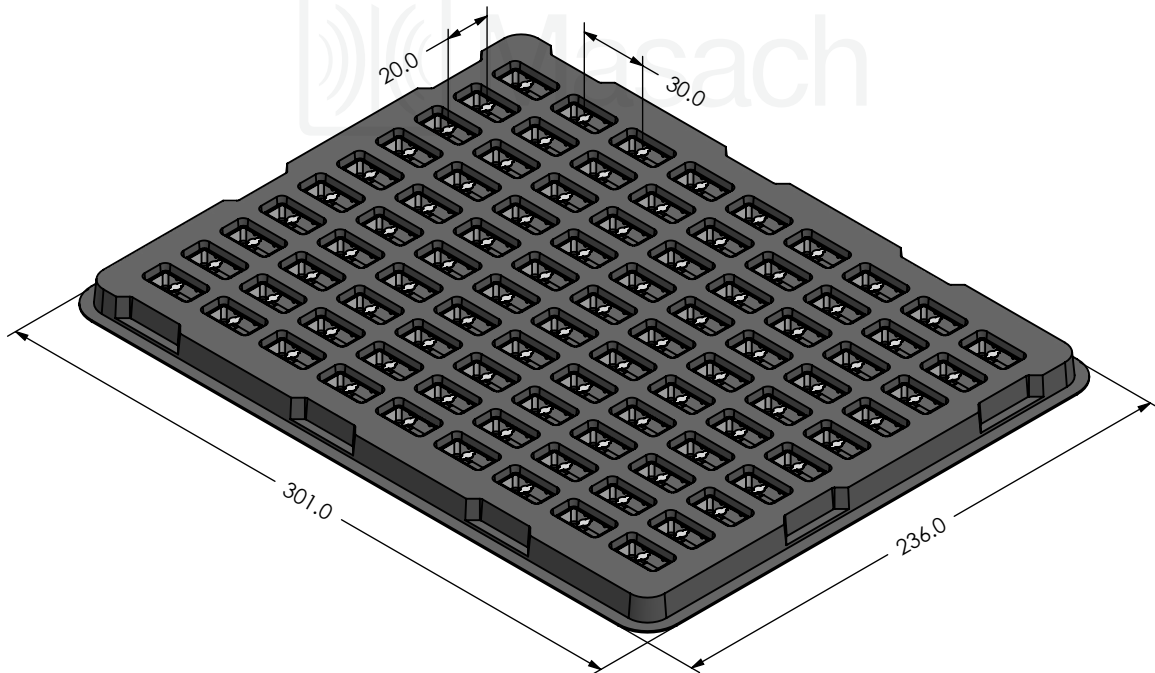

MS PN:

DESCRIPTION:

MATERIAL:

© MASACH TECH LTD.
 22 HAGANAN, MODIIN 7169513 ISRAEL
 T: (+972) 8-9754681 / F: (+972) 8-9754682
 info@masach.com / www.masach.com

SHIELD TYPE:

SEAMLESS PROTECTIVE EMI/RFI CAGE

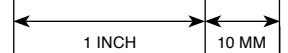

MMGS / PRINT 1:1 / A4

This product has been designed and manufactured by © Masach Tech Ltd. The use of this product in any type of electronic device or application is not under Masach Tech Ltd. liability.

[BACK TO TOP](#)

Компания «Океан Электроники» предлагает заключение долгосрочных отношений при поставках импортных электронных компонентов на взаимовыгодных условиях!

Наши преимущества:

- Поставка оригинальных импортных электронных компонентов напрямую с производств Америки, Европы и Азии, а так же с крупнейших складов мира;
- Широкая линейка поставок активных и пассивных импортных электронных компонентов (более 30 млн. наименований);
- Поставка сложных, дефицитных, либо снятых с производства позиций;
- Оперативные сроки поставки под заказ (от 5 рабочих дней);
- Экспресс доставка в любую точку России;
- Помощь Конструкторского Отдела и консультации квалифицированных инженеров;
- Техническая поддержка проекта, помощь в подборе аналогов, поставка прототипов;
- Поставка электронных компонентов под контролем ВП;
- Система менеджмента качества сертифицирована по Международному стандарту ISO 9001;
- При необходимости вся продукция военного и аэрокосмического назначения проходит испытания и сертификацию в лаборатории (по согласованию с заказчиком);
- Поставка специализированных компонентов военного и аэрокосмического уровня качества (Xilinx, Altera, Analog Devices, Intersil, Interpoint, Microsemi, Actel, Aeroflex, Peregrine, VPT, Syfer, Eurofarad, Texas Instruments, MS Kennedy, Miteq, Cobham, E2V, MA-COM, Hittite, Mini-Circuits, General Dynamics и др.);

Компания «Океан Электроники» является официальным дистрибьютором и эксклюзивным представителем в России одного из крупнейших производителей разъемов военного и аэрокосмического назначения «**JONHON**», а так же официальным дистрибьютором и эксклюзивным представителем в России производителя высокотехнологичных и надежных решений для передачи СВЧ сигналов «**FORSTAR**».



JONHON

«**JONHON**» (основан в 1970 г.)

Разъемы специального, военного и аэрокосмического назначения:

(Применяются в военной, авиационной, аэрокосмической, морской, железнодорожной, горно- и нефтедобывающей отраслях промышленности)

«**FORSTAR**» (основан в 1998 г.)

ВЧ соединители, коаксиальные кабели,
кабельные сборки и микроволновые компоненты:

(Применяются в телекоммуникациях гражданского и специального назначения, в средствах связи, РЛС, а так же военной, авиационной и аэрокосмической отраслях промышленности).



Телефон: 8 (812) 309-75-97 (многоканальный)

Факс: 8 (812) 320-03-32

Электронная почта: ocean@oceanchips.ru

Web: <http://oceanchips.ru/>

Адрес: 198099, г. Санкт-Петербург, ул. Калинина, д. 2, корп. 4, лит. А