

# ULTRA LOW CURRENT CONSUMPTION AND LOW DROPOUT CMOS VOLTAGE REGULATOR **S-1206 Series**

The S-1206 Series is a positive voltage regulator with ultra low current consumption, low dropout voltage, high output voltage accuracy, and 250 mA output current developed based on CMOS technology.

I/O capacitors are as small as 0.1  $\mu\text{F}$ . S-1206 Series operates at ultra low current consumption of 1.0  $\mu\text{A}$  (typ.).

The built-in low-on-resistance transistor realizes low dropout voltage and high output current. A built-in overcurrent protection circuit prevents the load current from exceeding the current capacitance of the output transistor.

Three packages, SOT-23-3, SOT-89-3, and SNT-6A(H), are available.

Compared with voltage regulators using a conventional CMOS process, more types of capacitors, including small I/O capacitors, can be used with the S-1206 Series. The S-1206 Series features ultra-low current consumption and comes in a small package, making them most suitable for portable equipment.

## ■ Features

- Output voltage : 1.2 to 5.2 V, selectable in 0.05 V steps.
- Low equivalent series resistance capacitor can be used : A ceramic capacitor of 0.1  $\mu\text{F}$  or more can be used for the I/O capacitor.
- Wide input voltage range : 1.7 to 6.5 V
- High-accuracy output voltage :  $\pm 1.0\%$  (1.2 to 1.45 V output product :  $\pm 15$  mV)
- Low dropout voltage : 150 mV typ. (3.0 V output product, at  $I_{\text{OUT}} = 100$  mA)
- Low current consumption : During operation : 1.0  $\mu\text{A}$  typ., 1.5  $\mu\text{A}$  max.
- High output current : 250 mA output is possible. (3.0 V output product, at  $V_{\text{IN}} \geq V_{\text{OUT(S)}} + 1.0$  V)<sup>\*1</sup>
- Built-in overcurrent protection circuit : Overcurrent of output transistor can be restricted.
- Small package : SOT-23-3, SOT-89-3, SNT-6A(H)
- Lead-free products

\*1. Attention should be paid to the power dissipation of the package when the output current is large.

## ■ Applications

- Power supply for battery-powered devices
- Constant-voltage power supply for cellular phones
- Constant-voltage power supply for portable equipments

## ■ Packages

Package Name	Drawing Code			
	Package	Tape	Reel	Land
SOT-23-3	MP003-Z	MP003-Z	MP003-Z	-
SOT-89-3	UP003-A	UP003-A	UP003-A	-
SNT-6A(H)	PI006-A	PI006-A	PI006-A	PI006-A

■ Block Diagram

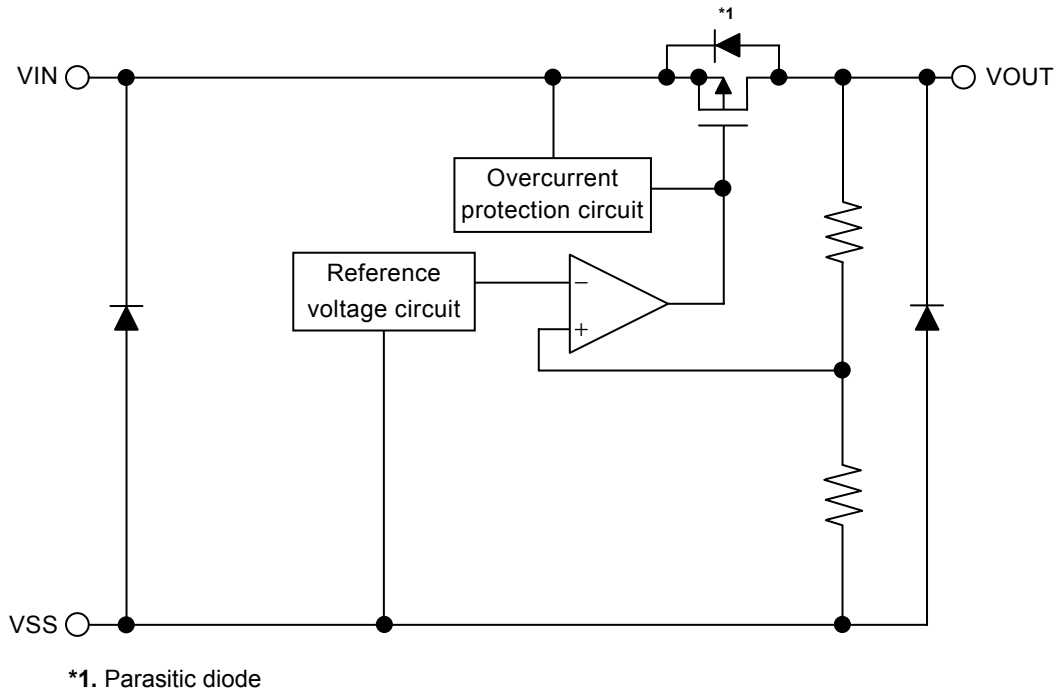
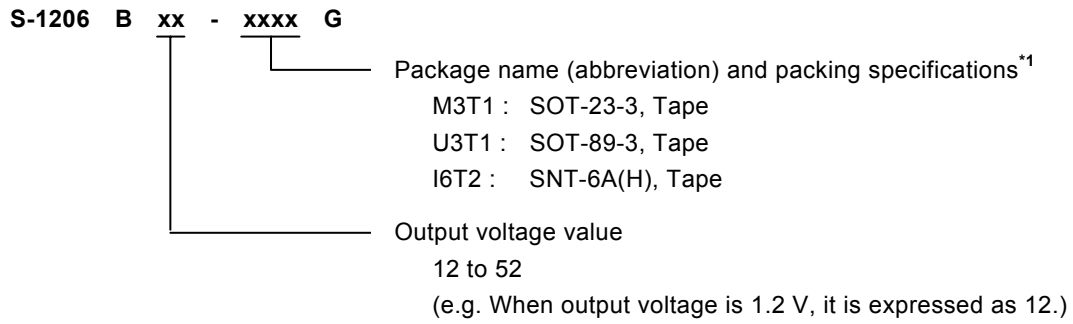

Figure 1

■ **Product Name Structure**

The output voltage value and package types for the S-1206 Series can be selected at the user's request. Refer to "1. Product Name" for the construction of the product name and "2. Product Name List" for the full product names.

**1. Product Name**



\*1. Refer to the taping specifications.

2. Product Name List

Table 1

Output Voltage	SOT-23-3	SOT-89-3	SNT-6A(H)
1.2 V $\pm$ 15 mV	S-1206B12-M3T1G	S-1206B12-U3T1G	S-1206B12-I6T2G
1.3 V $\pm$ 15 mV	S-1206B13-M3T1G	S-1206B13-U3T1G	S-1206B13-I6T2G
1.4 V $\pm$ 15 mV	S-1206B14-M3T1G	S-1206B14-U3T1G	S-1206B14-I6T2G
1.5 V $\pm$ 1.0%	S-1206B15-M3T1G	S-1206B15-U3T1G	S-1206B15-I6T2G
1.6 V $\pm$ 1.0%	S-1206B16-M3T1G	S-1206B16-U3T1G	S-1206B16-I6T2G
1.7 V $\pm$ 1.0%	S-1206B17-M3T1G	S-1206B17-U3T1G	S-1206B17-I6T2G
1.8 V $\pm$ 1.0%	S-1206B18-M3T1G	S-1206B18-U3T1G	S-1206B18-I6T2G
1.85 V $\pm$ 1.0%	S-1206B1J-M3T1G	S-1206B1J-U3T1G	S-1206B1J-I6T2G
1.9 V $\pm$ 1.0%	S-1206B19-M3T1G	S-1206B19-U3T1G	S-1206B19-I6T2G
2.0 V $\pm$ 1.0%	S-1206B20-M3T1G	S-1206B20-U3T1G	S-1206B20-I6T2G
2.1 V $\pm$ 1.0%	S-1206B21-M3T1G	S-1206B21-U3T1G	S-1206B21-I6T2G
2.2 V $\pm$ 1.0%	S-1206B22-M3T1G	S-1206B22-U3T1G	S-1206B22-I6T2G
2.3 V $\pm$ 1.0%	S-1206B23-M3T1G	S-1206B23-U3T1G	S-1206B23-I6T2G
2.4 V $\pm$ 1.0%	S-1206B24-M3T1G	S-1206B24-U3T1G	S-1206B24-I6T2G
2.5 V $\pm$ 1.0%	S-1206B25-M3T1G	S-1206B25-U3T1G	S-1206B25-I6T2G
2.6 V $\pm$ 1.0%	S-1206B26-M3T1G	S-1206B26-U3T1G	S-1206B26-I6T2G
2.7 V $\pm$ 1.0%	S-1206B27-M3T1G	S-1206B27-U3T1G	S-1206B27-I6T2G
2.8 V $\pm$ 1.0%	S-1206B28-M3T1G	S-1206B28-U3T1G	S-1206B28-I6T2G
2.85 V $\pm$ 1.0%	S-1206B2J-M3T1G	S-1206B2J-U3T1G	S-1206B2J-I6T2G
2.9 V $\pm$ 1.0%	S-1206B29-M3T1G	S-1206B29-U3T1G	S-1206B29-I6T2G
3.0 V $\pm$ 1.0%	S-1206B30-M3T1G	S-1206B30-U3T1G	S-1206B30-I6T2G
3.1 V $\pm$ 1.0%	S-1206B31-M3T1G	S-1206B31-U3T1G	S-1206B31-I6T2G
3.2 V $\pm$ 1.0%	S-1206B32-M3T1G	S-1206B32-U3T1G	S-1206B32-I6T2G
3.3 V $\pm$ 1.0%	S-1206B33-M3T1G	S-1206B33-U3T1G	S-1206B33-I6T2G
3.4 V $\pm$ 1.0%	S-1206B34-M3T1G	S-1206B34-U3T1G	S-1206B34-I6T2G
3.5 V $\pm$ 1.0%	S-1206B35-M3T1G	S-1206B35-U3T1G	S-1206B35-I6T2G
3.6 V $\pm$ 1.0%	S-1206B36-M3T1G	S-1206B36-U3T1G	S-1206B36-I6T2G
3.7 V $\pm$ 1.0%	S-1206B37-M3T1G	S-1206B37-U3T1G	S-1206B37-I6T2G
3.8 V $\pm$ 1.0%	S-1206B38-M3T1G	S-1206B38-U3T1G	S-1206B38-I6T2G
3.9 V $\pm$ 1.0%	S-1206B39-M3T1G	S-1206B39-U3T1G	S-1206B39-I6T2G
4.0 V $\pm$ 1.0%	S-1206B40-M3T1G	S-1206B40-U3T1G	S-1206B40-I6T2G
4.1 V $\pm$ 1.0%	S-1206B41-M3T1G	S-1206B41-U3T1G	S-1206B41-I6T2G
4.2 V $\pm$ 1.0%	S-1206B42-M3T1G	S-1206B42-U3T1G	S-1206B42-I6T2G
4.3 V $\pm$ 1.0%	S-1206B43-M3T1G	S-1206B43-U3T1G	S-1206B43-I6T2G
4.4 V $\pm$ 1.0%	S-1206B44-M3T1G	S-1206B44-U3T1G	S-1206B44-I6T2G
4.5 V $\pm$ 1.0%	S-1206B45-M3T1G	S-1206B45-U3T1G	S-1206B45-I6T2G
4.6 V $\pm$ 1.0%	S-1206B46-M3T1G	S-1206B46-U3T1G	S-1206B46-I6T2G
4.7 V $\pm$ 1.0%	S-1206B47-M3T1G	S-1206B47-U3T1G	S-1206B47-I6T2G
4.8 V $\pm$ 1.0%	S-1206B48-M3T1G	S-1206B48-U3T1G	S-1206B48-I6T2G
4.9 V $\pm$ 1.0%	S-1206B49-M3T1G	S-1206B49-U3T1G	S-1206B49-I6T2G
5.0 V $\pm$ 1.0%	S-1206B50-M3T1G	S-1206B50-U3T1G	S-1206B50-I6T2G
5.1 V $\pm$ 1.0%	S-1206B51-M3T1G	S-1206B51-U3T1G	S-1206B51-I6T2G
5.2 V $\pm$ 1.0%	S-1206B52-M3T1G	S-1206B52-U3T1G	S-1206B52-I6T2G

**Remark** Please contact our sales office for products with output voltage values other than the above.

■ Pin Configurations

SOT-23-3  
 Top view



Figure 2

Table 2

Pin No.	Symbol	Description
1	VIN	Input voltage pin
2	VSS	GND pin
3	VOUT	Output voltage pin

SOT-89-3  
 Top view

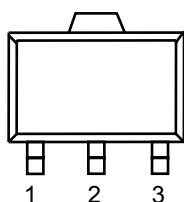

Figure 3

Table 3

Pin No.	Symbol	Description
1	VSS	GND pin
2	VIN	Input voltage pin
3	VOUT	Output voltage pin

SNT-6A(H)  
 Top view

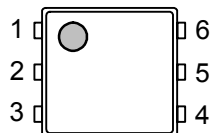

Figure 4

Table 4

Pin No.	Symbol	Description
1	VOUT	Output voltage pin
2	VIN	Input voltage pin
3	VSS	GND pin
4	NC <sup>*1</sup>	No connection
5	VIN	Input voltage pin
6	NC <sup>*1</sup>	No connection

\*1. The NC pin is electrically open.  
 The NC pin can be connected to VIN or VSS.

■ **Absolute Maximum Ratings**

**Table 5**

(Ta = 25 °C unless otherwise specified)

Item	Symbol	Absolute Maximum Rating	Unit
Input voltage	$V_{IN}$	$V_{SS} - 0.3$ to $V_{SS} + 7$	V
Output voltage	$V_{OUT}$	$V_{SS} - 0.3$ to $V_{IN} + 0.3$	V
Power dissipation	SOT-23-3	430 <sup>*1</sup>	mW
	SOT-89-3	1000 <sup>*1</sup>	mW
	SNT-6A(H)	500 <sup>*1</sup>	mW
Operating ambient temperature	$T_{opr}$	-40 to +85	°C
Storage temperature	$T_{stg}$	-40 to +125	°C

\*1. When mounted on board

[Mounted board]

- (1) Board size : 114.3 mm × 76.2 mm × t1.6 mm
- (2) Board name : JEDEC STANDARD51-7

**Caution** The absolute maximum ratings are rated values exceeding which the product could suffer physical damage. These values must therefore not be exceeded under any conditions.

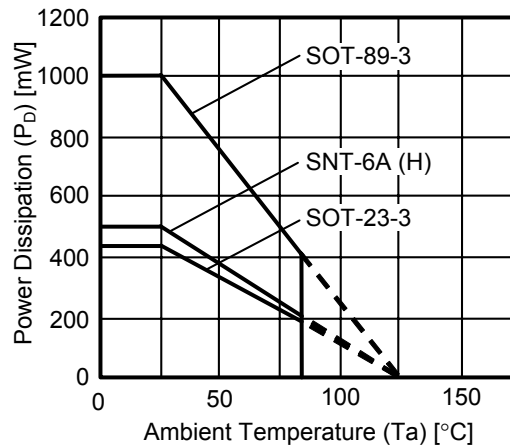

**Figure 5 Power Dissipation of Package (When Mounted on Board)**

■ Electrical Characteristics

Table 6

(Ta = 25 °C unless otherwise specified)

Item	Symbol	Condition	Min.	Typ.	Max.	Unit	Measurement Circuit	
Output voltage*1	V <sub>OUT(E)</sub>	V <sub>IN</sub> = V <sub>OUT(S)</sub> + 1.0 V, I <sub>OUT</sub> = 30 mA, 1.2 V ≤ V <sub>OUT(S)</sub> < 1.5 V	V <sub>OUT(S)</sub> -15 mV	V <sub>OUT(S)</sub>	V <sub>OUT(S)</sub> +15 mV	V	1	
		V <sub>IN</sub> = V <sub>OUT(S)</sub> + 1.0 V, I <sub>OUT</sub> = 30 mA, 1.5 V ≤ V <sub>OUT(S)</sub>	V <sub>OUT(S)</sub> × 0.99	V <sub>OUT(S)</sub>	V <sub>OUT(S)</sub> × 1.01	V	1	
Output current*2	I <sub>OUT</sub>	V <sub>IN</sub> ≥ V <sub>OUT(S)</sub> + 1.0 V, 1.2 V ≤ V <sub>OUT(S)</sub> < 1.5 V	150*5	–	–	mA	3	
		V <sub>IN</sub> ≥ V <sub>OUT(S)</sub> + 1.0 V, 1.5 V ≤ V <sub>OUT(S)</sub>	250*5	–	–	mA	3	
Dropout voltage*3	V <sub>drop</sub>	I <sub>OUT</sub> = 100 mA	1.2 V ≤ V <sub>OUT(S)</sub> < 1.3 V	0.5	0.54	0.81	V	1
			1.3 V ≤ V <sub>OUT(S)</sub> < 1.4 V	–	0.50	0.73	V	1
			1.4 V ≤ V <sub>OUT(S)</sub> < 1.5 V	–	0.43	0.66	V	1
			1.5 V ≤ V <sub>OUT(S)</sub> < 1.7 V	–	0.35	0.53	V	1
			1.7 V ≤ V <sub>OUT(S)</sub> < 1.9 V	–	0.33	0.50	V	1
			1.9 V ≤ V <sub>OUT(S)</sub> < 2.1 V	–	0.26	0.43	V	1
			2.1 V ≤ V <sub>OUT(S)</sub> < 3.0 V	–	0.23	0.36	V	1
			3.0 V ≤ V <sub>OUT(S)</sub> ≤ 5.2 V	–	0.15	0.23	V	1
Line regulation	$\frac{\Delta V_{OUT1}}{\Delta V_{IN} \bullet V_{OUT}}$	V <sub>OUT(S)</sub> + 0.5 V ≤ V <sub>IN</sub> ≤ 6.5 V	I <sub>OUT</sub> = 1 μA	–	0.05	0.2	%/V	1
			I <sub>OUT</sub> = 30 mA	–	0.05	0.2	%/V	1
Load regulation	ΔV <sub>OUT2</sub>	V <sub>IN</sub> = V <sub>OUT(S)</sub> + 1.0 V, 1 μA ≤ I <sub>OUT</sub> ≤ 100 mA	–	20	40	mV	1	
Output voltage temperature coefficient*4	$\frac{\Delta V_{OUT}}{\Delta Ta \bullet V_{OUT}}$	V <sub>IN</sub> = V <sub>OUT(S)</sub> + 1.0 V, I <sub>OUT</sub> = 30 mA, -40 ≤ Ta ≤ 85°C	–	±120	–	ppm/°C	1	
Current consumption during operation	I <sub>SS1</sub>	V <sub>IN</sub> = V <sub>OUT(S)</sub> + 1.0 V, no load	–	1.0	1.5	μA	2	
Input voltage	V <sub>IN</sub>	–	1.7	–	6.5	V	–	
Short-circuit current	I <sub>SHORT</sub>	V <sub>IN</sub> = V <sub>OUT(S)</sub> + 1.0 V, V <sub>OUT</sub> = 0 V	1.2 V ≤ V <sub>OUT</sub> < 2.3 V	–	130	–	mA	3
			2.3 V ≤ V <sub>OUT</sub> ≤ 5.2 V	–	100	–	mA	3

\*1. V<sub>OUT(S)</sub> : Specified output voltage

V<sub>OUT(E)</sub> : Actual output voltage at the fixed load

Output voltage when fixing I<sub>OUT</sub> (= 30 mA) and inputting V<sub>OUT(S)</sub> + 1.0 V

\*2. Output current at which the output voltage becomes 95% of V<sub>OUT(E)</sub> after gradually increasing the output current.

\*3. V<sub>drop</sub> = V<sub>IN1</sub> - (V<sub>OUT3</sub> × 0.98)

V<sub>OUT3</sub> : Output voltage when V<sub>IN</sub> = V<sub>OUT(S)</sub> + 1.0 V and I<sub>OUT</sub> = 100 mA

V<sub>IN1</sub> : Input voltage at which the output voltage becomes 98% of V<sub>OUT3</sub> after gradually decreasing the input voltage

\*4. The change in temperature [mV / °C] is calculated using the following equation.

$$\frac{\Delta V_{OUT}}{\Delta Ta} [\text{mV}/^\circ\text{C}]^*1 = V_{OUT(S)} [\text{V}]^*2 \times \frac{\Delta V_{OUT}}{\Delta Ta \bullet V_{OUT}} [\text{ppm}/^\circ\text{C}]^*3 \div 1000$$

\*1. Temperature change ratio of the output voltage

\*2. Specified output voltage

\*3. Output voltage temperature coefficient

\*5. The output current can be supplied at least to this value.

Due to restrictions on the package power dissipation, this value may not be satisfied. Attention should be paid to the power dissipation of the package when the output current is large.

This specification is guaranteed by design.

■ Measurement Circuits



Figure 6

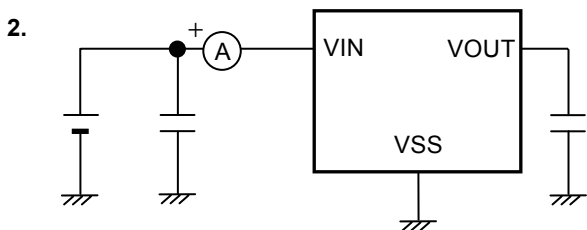

Figure 7

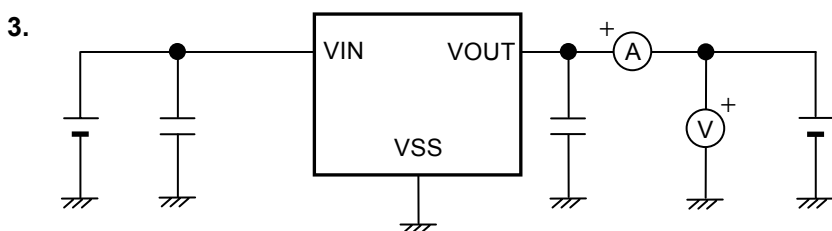
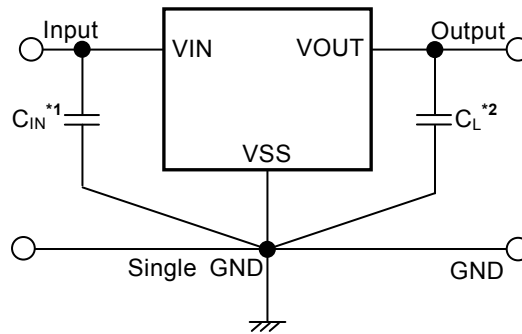

Figure 8



### ■ Standard Circuit



- \*1. A capacitor for stabilizing the input.
- \*2. A ceramic capacitor of 0.1  $\mu\text{F}$  or more can be used.

Figure 9

**Caution** The above connection diagram and constant will not guarantee successful operation. Perform thorough evaluation using the actual application to set the constant.

### ■ Application Conditions

Input capacitor ( $C_{IN}$ ) : 0.1  $\mu\text{F}$  or more  
Output capacitor ( $C_L$ ) : 0.1  $\mu\text{F}$  or more (ceramic capacitor)

**Caution** A general series regulator may oscillate, depending on the external components selected. Check that no oscillation occurs in the actual device using the above capacitor.

### ■ Selection of Input Capacitor ( $C_{IN}$ ) and Output Capacitor ( $C_L$ )

The S-1206 Series requires an output capacitor between the VOUT pin and VSS pin for phase compensation. Operation is stabilized by a ceramic capacitor with an output capacitance of 0.1  $\mu\text{F}$  or more in the entire temperature range. However, when using an OS capacitor, tantalum capacitor, or aluminum electrolytic capacitor with a capacitance of 0.1  $\mu\text{F}$  or more less is required.

The value of the output overshoot or undershoot transient response varies depending on the value of the output capacitor.

The required capacitance of the input capacitor differs depending on the application.

The recommended value for an application is 0.1  $\mu\text{F}$  or more for  $C_{IN}$  and 0.1  $\mu\text{F}$  or more for  $C_L$ ; however, when selecting these capacitors, perform sufficient evaluation, including evaluation of temperature characteristics, on the actual device.

## ■ Technical Terms

### 1. Low Dropout Voltage Regulator

The low dropout voltage regulator is a voltage regulator whose dropout voltage is low due to its built-in low-on-resistance transistor.

### 2. Low Equivalent Series Resistance

A capacitor whose equivalent series resistance ( $R_{ESR}$ ) is low. The S-1206 Series enables use of a low equivalent series resistance capacitor, such as a ceramic capacitor, for the output-side capacitor ( $C_L$ ).

### 3. Output Voltage ( $V_{OUT}$ )

The accuracy of the output voltage is ensured at  $\pm 1.0\%$  or  $\pm 15 \text{ mV}^2$  under the specified conditions of fixed input voltage<sup>\*1</sup>, fixed output current, and fixed temperature.

\*1. Differs depending on the product.

\*2. When  $V_{OUT} < 1.5 \text{ V} : \pm 15 \text{ mV}$ , When  $1.5 \text{ V} \leq V_{OUT} : \pm 1.0\%$

**Caution** If the above conditions change, the output voltage value may vary and exceed the accuracy range of the output voltage. Refer to the “■ Electrical Characteristics” and “■ Characteristics (Typical Data)” for details.

### 4. Line Regulation $\left( \frac{\Delta V_{OUT1}}{\Delta V_{IN} \cdot V_{OUT}} \right)$

Indicates the dependency of the output voltage on the input voltage. That is, the values show how much the output voltage changes due to a change in the input voltage with the output current remaining unchanged.

### 5. Load Regulation ( $\Delta V_{OUT2}$ )

Indicates the dependency of the output voltage on the output current. That is, the values show how much the output voltage changes due to a change in the output current with the input voltage remaining unchanged.

### 6. Dropout Voltage ( $V_{drop}$ )

Indicates the difference between the input voltage ( $V_{IN1}$ ), which is the input voltage ( $V_{IN}$ ) at the point where the output voltage has fallen to 98% of the output voltage value ( $V_{OUT3}$ ) after  $V_{IN}$  was gradually decreased from  $V_{IN} = V_{OUT(S)} + 1.0 \text{ V}$ , and the output voltage at that point ( $V_{OUT3} \times 0.98$ ).

$$V_{drop} = V_{IN1} - (V_{OUT3} \times 0.98)$$

**7. Temperature Coefficient of Output Voltage**  $\left( \frac{\Delta V_{OUT}}{\Delta T_a \bullet V_{OUT}} \right)$

The shadowed area in **Figure 10** is the range where  $V_{OUT}$  varies in the operating temperature range when the temperature coefficient of the output voltage is  $\pm 120 \text{ ppm}/^\circ\text{C}$ .

e.g. S-1206B30 Typ.

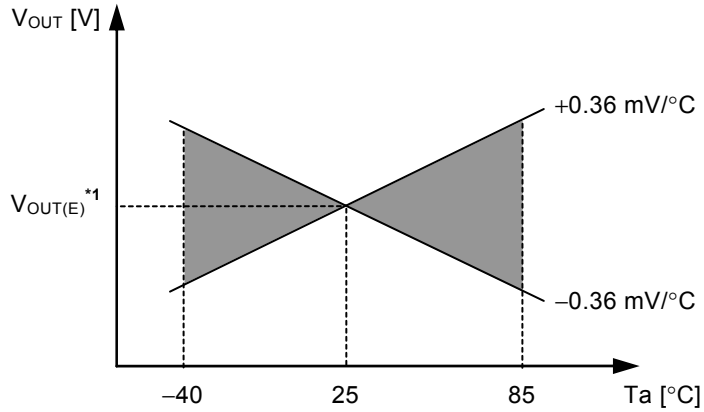

\*1.  $V_{OUT(E)}$  is the value of the output voltage measured at 25°C.

**Figure 10**

A change in the temperature of the output voltage [ $\text{mV}/^\circ\text{C}$ ] is calculated using the following equation.

$$\frac{\Delta V_{OUT}}{\Delta T_a} [\text{mV}/^\circ\text{C}]^{*1} = V_{OUT(S)} [\text{V}]^{*2} \times \frac{\Delta V_{OUT}}{\Delta T_a \bullet V_{OUT}} [\text{ppm}/^\circ\text{C}]^{*3} \div 1000$$

- \*1. The temperature change ratio of the output voltage
- \*2. Specified output voltage
- \*3. Output voltage temperature coefficient

■ **Operation**

**1. Basic Operation**

Figure 11 shows the block diagram of the S-1206 Series.

The error amplifier compares the reference voltage ( $V_{ref}$ ) with  $V_{fb}$ , which is the output voltage resistance-divided by feedback resistors  $R_s$  and  $R_f$ . It supplies the output transistor with the gate voltage necessary to ensure a certain output voltage free of any fluctuations of input voltage and temperature.



\*1. Parasitic diode

Figure 11

**2. Output Transistor**

The S-1206 Series uses a low-on-resistance P-channel MOS FET as the output transistor.

Be sure that  $V_{OUT}$  does not exceed  $V_{IN} + 0.3$  V to prevent the IC from being damaged due to inverse current flowing from the VOUT pin through a parasitic diode to the VIN pin.

### 3. Overcurrent protection circuit

An overcurrent protection circuit with the characteristics shown in **(1) Output Voltage vs. Output Current (Ta = 25 °C)** in “■ Characteristics (Typical Data)” is built into the S-1206 Series to protect output transistors from excessive output current and short circuiting between the VOUT and VSS pins. The current when output short circuiting ( $I_{SHORT}$ ) is internally set to 100 mA (typ.) ( $V_{OUT} \geq 2.3$  V) and the output voltage returns to the normal value when short circuiting has been released. Note that the overcurrent protection circuit does not function as a circuit for thermal protection. Therefore, in cases where a short circuiting status may continue for a long time, pay sufficient attention to the input voltage and load current conditions so that the loss of the IC will not exceed power dissipation of the package under use conditions, including short circuiting conditions.

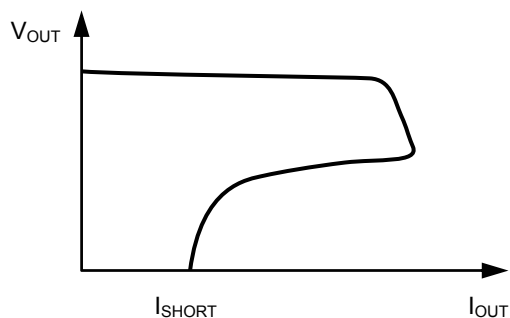

Figure 12  $V_{OUT}$  vs.  $I_{OUT}$  Characteristics

## ■ Precautions

- Wiring patterns for the VIN pin, VOUT pin and GND pin should be designed so that the impedance is low. When mounting an output capacitor between the VOUT pin and VSS pin ( $C_L$ ) and a capacitor for stabilizing the input between the VIN pin and VSS pin ( $C_{IN}$ ), the distance from the capacitors to these pins should be as short as possible.
- Note that the output voltage may generally increase when a series regulator is used at low load current (10  $\mu$ A or less).
- Note that the output voltage may generally increase due to driver leakage when a series regulator is used at high temperatures.
- Generally a series regulator may cause oscillation, depending on the selection of external parts. The following conditions are recommended for this IC. However, be sure to perform sufficient evaluation under the actual usage conditions for selection, including evaluation of temperature characteristics. For the equivalent series resistance ( $R_{ESR}$ ) of the output capacitor, refer to **(5) Equivalent Series Resistance vs. Output Current Characteristics Example (Ta = 25°C)** in “■ Reference Data”.

Input capacitor ( $C_{IN}$ ) :	0.1 $\mu$ F or more
Output capacitor ( $C_L$ ) :	0.1 $\mu$ F or more

Use an I/O capacitor with good temperature characteristics (conforming to the ceramic capacitor EIA X5R (JIS B) characteristics).

- The voltage regulator may oscillate when the impedance of the power supply is high and the input capacitance is small or an input capacitor is not connected.
- If the output capacitance is small, the power supply fluctuation and load fluctuation characteristics become worse. Sufficiently evaluate the output voltage fluctuation with the actual device.
- If the power supply suddenly increases sharply when the output capacitance is small, a momentary overshoot may be output. It is therefore important to sufficiently evaluate the output voltage at power application in the actual device.
- The application conditions for the input voltage, output voltage, and load current should not exceed the package power dissipation.
- Do not apply an electrostatic discharge to this IC that exceeds the performance ratings of the built-in electrostatic protection circuit.
- In determining the output current, attention should be paid to the output current value specified in **Table 6** in “■ Electrical Characteristics” and footnote \*5 of the table.
- SII claims no responsibility for any disputes arising out of or in connection with any infringement by products including this IC of patents owned by a third party.

■ Characteristics (Typical Data)

(1) Output Voltage vs. Output Current (Ta = 25 °C)

S-1206B12



S-1206B30



S-1206B50



**Remark** In determining the output current, attention should be paid to the following.

1. Minimum output current value specified in **Table 6** and footnote \*5 in "■ Electrical Characteristics"
2. Power dissipation of package

(2) Output Voltage vs. Input Voltage (Ta = 25 °C)

S-1206B12

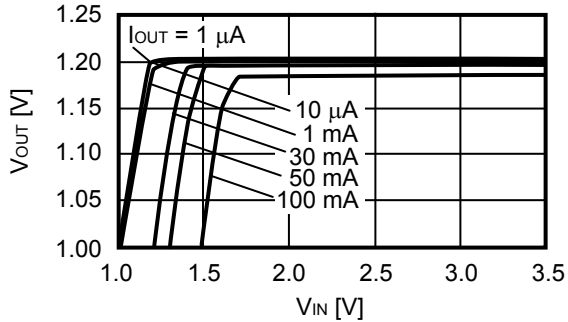

S-1206B30

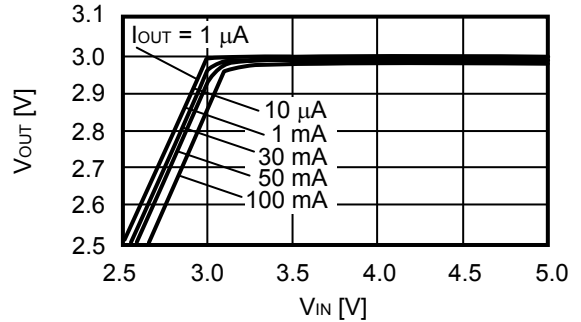

S-1206B50



**(3) Dropout Voltage vs. Output Current**

S-1206B12

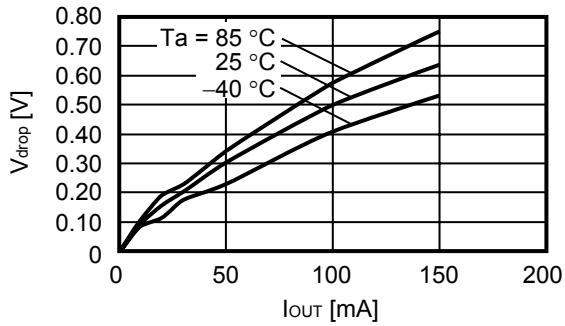

S-1206B30



S-1206B50

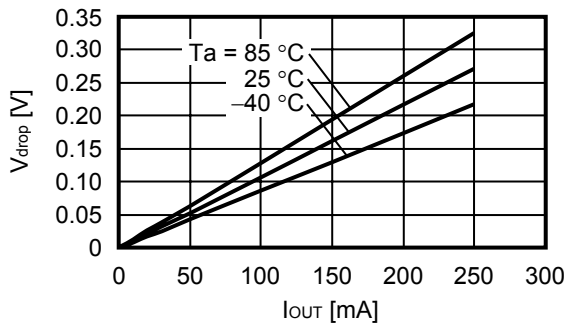

**(4) Dropout Voltage vs. Set Output Voltage**

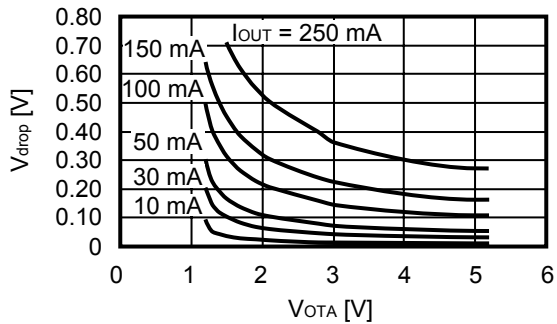



**(5) Output Voltage vs. Ambient Temperature**

S-1206B12

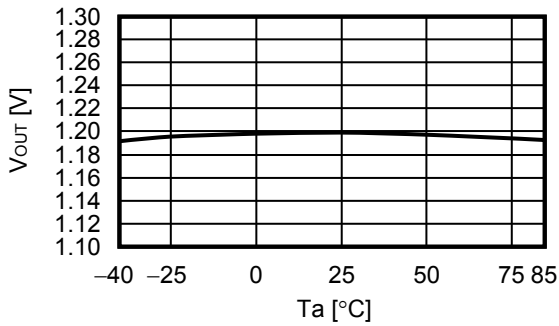

S-1206B30

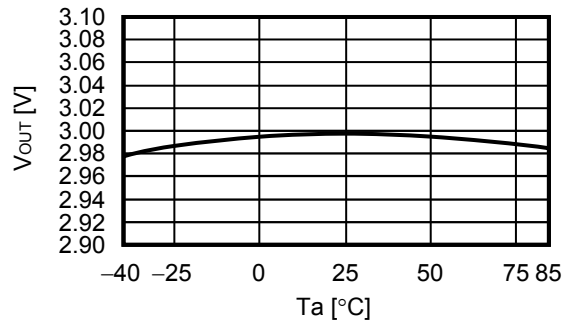

S-1206B50



**(6) Current Consumption vs. Input Voltage**

S-1206B12



S-1206B30

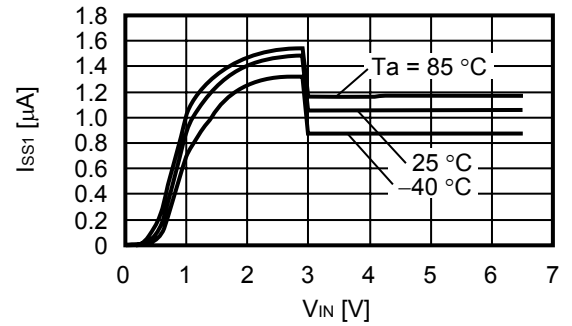

S-1206B50

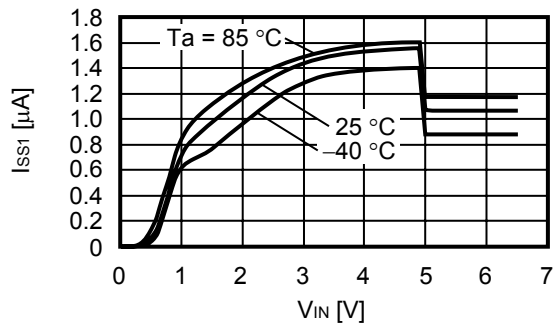

**(7) Current Consumption vs. Ambient Temperature**

S-1206B12

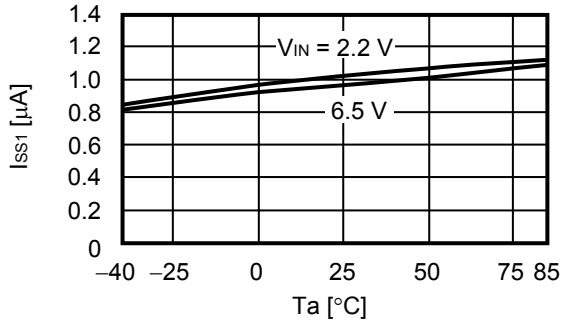

S-1206B30

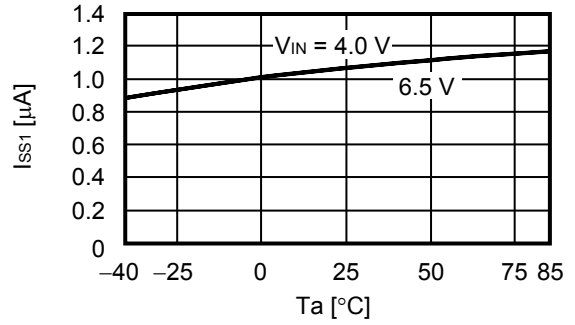

S-1206B50

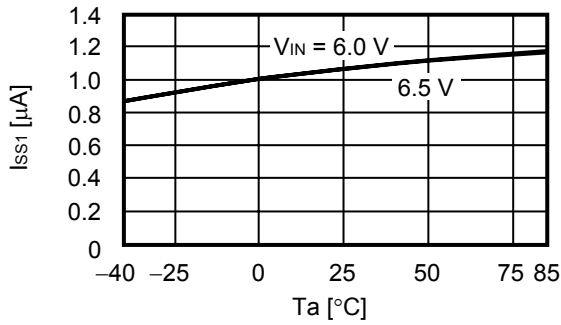

■ Reference Data

(1) Input Transient Response Characteristics (Ta = 25 °C)

S-1206B12

I<sub>OUT</sub> = 1 mA, tr = tf = 5.0 μs



I<sub>OUT</sub> = 100 mA, tr = tf = 5.0 μs



S-1206B30

I<sub>OUT</sub> = 1 mA, tr = tf = 5.0 μs



I<sub>OUT</sub> = 100 mA, tr = tf = 5.0 μs



S-1206B50

I<sub>OUT</sub> = 1 mA, tr = tf = 5.0 μs

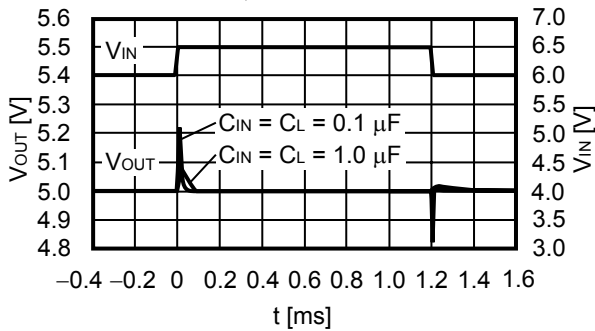

I<sub>OUT</sub> = 100 mA, tr = tf = 5.0 μs

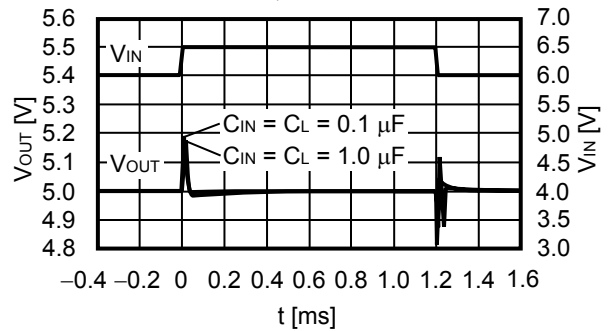

**(2) Load Transient Response Characteristics (Ta = 25 °C)**

S-1206B12

V<sub>IN</sub> = 2.2 V, I<sub>OUT</sub> = 1 ↔ 40 mA



V<sub>IN</sub> = 2.2 V, I<sub>OUT</sub> = 50 ↔ 100 mA



S-1206B30

V<sub>IN</sub> = 4.0 V, I<sub>OUT</sub> = 1 ↔ 40 mA



V<sub>IN</sub> = 4.0 V, I<sub>OUT</sub> = 50 ↔ 100 mA



S-1206B50

V<sub>IN</sub> = 6.0 V, I<sub>OUT</sub> = 1 ↔ 40 mA



V<sub>IN</sub> = 6.0 V, I<sub>OUT</sub> = 50 ↔ 100 mA



**(3) Input Voltage Transient Response Characteristics (Ta = 25 °C)**

S-1206B12

$V_{IN} = 2.2\text{ V}$ ,  $I_{OUT} = 1\text{ mA}$

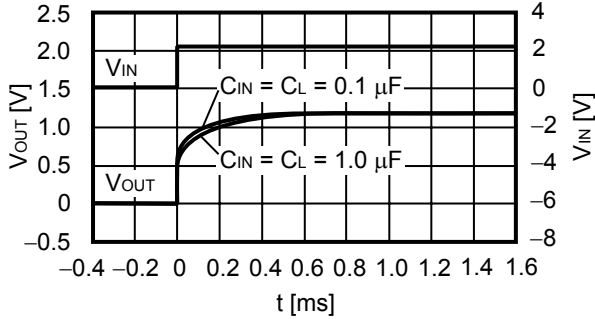

$V_{IN} = 2.2\text{ V}$ ,  $I_{OUT} = 100\text{ mA}$

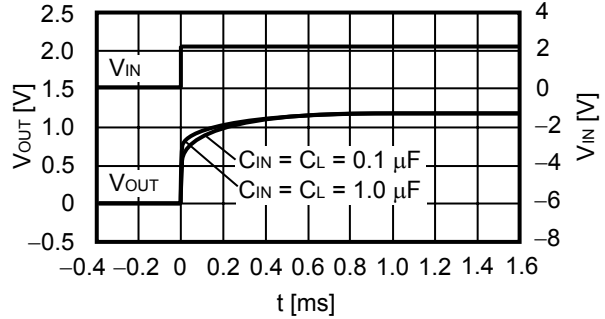

S-1206B30

$V_{IN} = 4.0\text{ V}$ ,  $I_{OUT} = 1\text{ mA}$

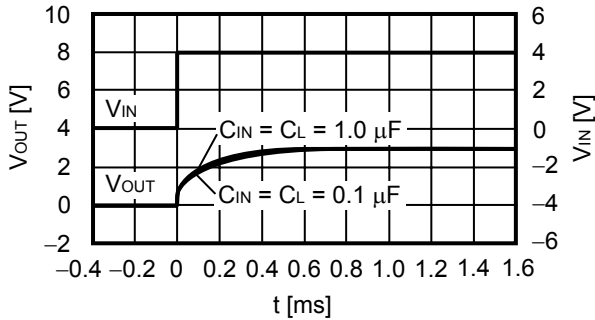

$V_{IN} = 4.0\text{ V}$ ,  $I_{OUT} = 100\text{ mA}$

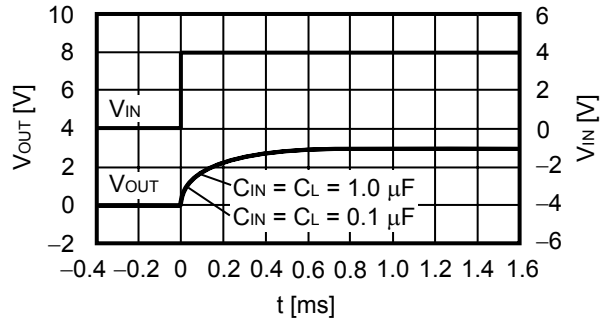

S-1206B50

$V_{IN} = 6.0\text{ V}$ ,  $I_{OUT} = 1\text{ mA}$

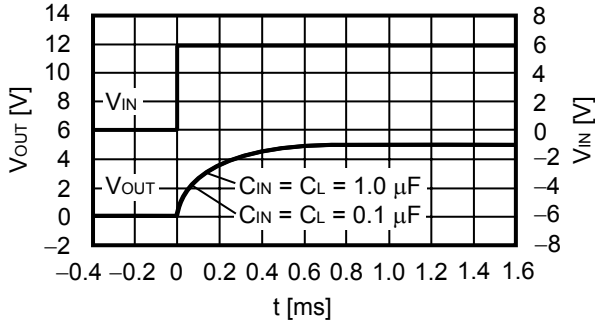

$V_{IN} = 6.0\text{ V}$ ,  $I_{OUT} = 100\text{ mA}$

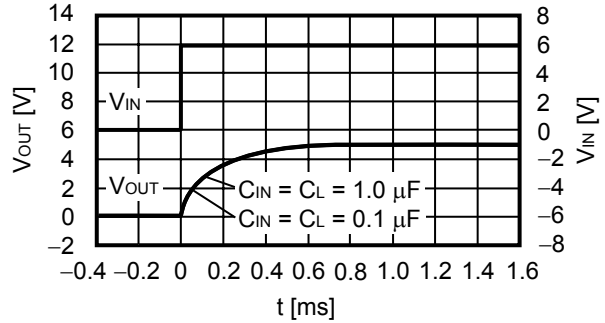

**(4) Ripple Rejection ( $T_a = 25\text{ }^\circ\text{C}$ )**

S-1206B12

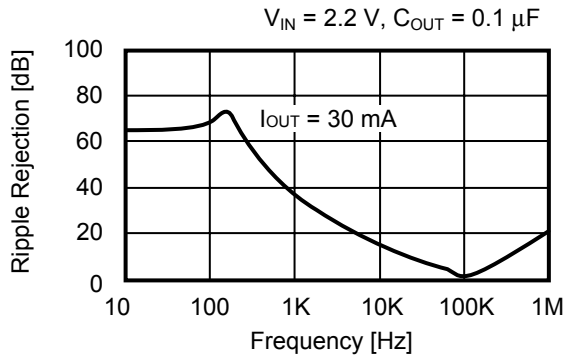

S-1206B30

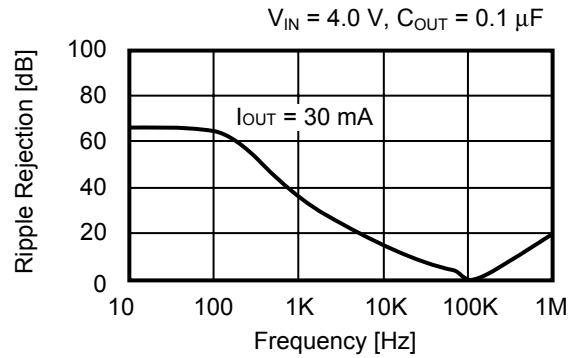

S-1206B50

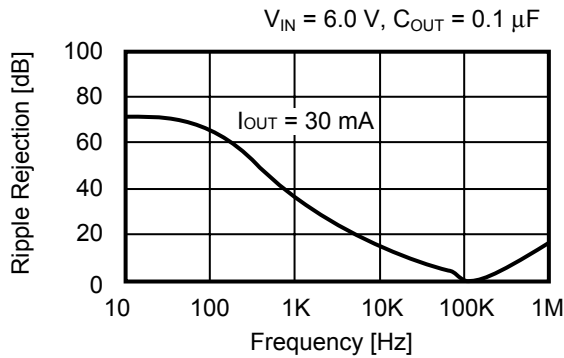

**(5) Equivalent Series Resistance vs. Output Current Characteristics Example ( $T_a = 25\text{ }^\circ\text{C}$ )**

$C_L$ : Murata Manufacturing Company, Ltd.  
 GRM115R71C104K (0.1  $\mu\text{F}$ )

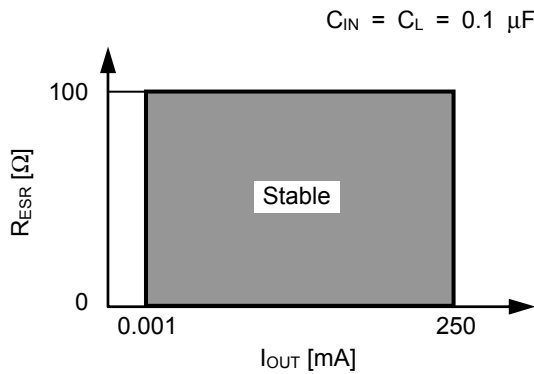

■ **Marking Specifications**

(1) **SOT-23-3**

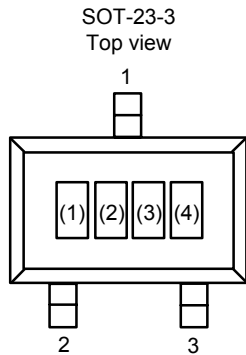

(1) to (3) : Product abbreviation (refer to **Product Name vs. Product Code**)  
 (4) : Lot number

**List of Product Name vs. Product Code**

Product Name	Product Code		
	(1)	(2)	(3)
S-1206B12-M3T1G	S	A	A
S-1206B13-M3T1G	S	A	B
S-1206B14-M3T1G	S	A	C
S-1206B15-M3T1G	S	A	D
S-1206B16-M3T1G	S	A	E
S-1206B17-M3T1G	S	A	F
S-1206B18-M3T1G	S	A	G
S-1206B1J-M3T1G	S	A	H
S-1206B19-M3T1G	S	A	I
S-1206B20-M3T1G	S	A	J
S-1206B21-M3T1G	S	A	K
S-1206B22-M3T1G	S	A	L
S-1206B23-M3T1G	S	A	M
S-1206B24-M3T1G	S	A	N
S-1206B25-M3T1G	S	A	O
S-1206B26-M3T1G	S	A	P
S-1206B27-M3T1G	S	A	Q
S-1206B28-M3T1G	S	A	R
S-1206B2J-M3T1G	S	A	S
S-1206B29-M3T1G	S	A	T
S-1206B30-M3T1G	S	A	U
S-1206B31-M3T1G	S	A	V

Product Name	Product Code		
	(1)	(2)	(3)
S-1206B32-M3T1G	S	A	W
S-1206B33-M3T1G	S	A	X
S-1206B34-M3T1G	S	A	Y
S-1206B35-M3T1G	S	A	Z
S-1206B36-M3T1G	S	B	A
S-1206B37-M3T1G	S	B	B
S-1206B38-M3T1G	S	B	C
S-1206B39-M3T1G	S	B	D
S-1206B40-M3T1G	S	B	E
S-1206B41-M3T1G	S	B	F
S-1206B42-M3T1G	S	B	G
S-1206B43-M3T1G	S	B	H
S-1206B44-M3T1G	S	B	I
S-1206B45-M3T1G	S	B	J
S-1206B46-M3T1G	S	B	K
S-1206B47-M3T1G	S	B	L
S-1206B48-M3T1G	S	B	M
S-1206B49-M3T1G	S	B	N
S-1206B50-M3T1G	S	B	O
S-1206B51-M3T1G	S	B	P
S-1206B52-M3T1G	S	B	Q

**Remark** Please contact our sales office for products with output voltage values other than the above.

# ULTRA LOW CURRENT CONSUMPTION AND LOW DROPOUT CMOS VOLTAGE REGULATOR

## S-1206 Series

Rev.1.1\_00

### (2) SOT-89-3



(1) to (3) : Product abbreviation (refer to **Product Name vs. Product Code**)

(4) to (6) : Lot number

### List of Product Name vs. Product Code

Product Name	Product Code		
	(1)	(2)	(3)
S-1206B12-U3T1G	S	A	A
S-1206B13-U3T1G	S	A	B
S-1206B14-U3T1G	S	A	C
S-1206B15-U3T1G	S	A	D
S-1206B16-U3T1G	S	A	E
S-1206B17-U3T1G	S	A	F
S-1206B18-U3T1G	S	A	G
S-1206B1J-U3T1G	S	A	H
S-1206B19-U3T1G	S	A	I
S-1206B20-U3T1G	S	A	J
S-1206B21-U3T1G	S	A	K
S-1206B22-U3T1G	S	A	L
S-1206B23-U3T1G	S	A	M
S-1206B24-U3T1G	S	A	N
S-1206B25-U3T1G	S	A	O
S-1206B26-U3T1G	S	A	P
S-1206B27-U3T1G	S	A	Q
S-1206B28-U3T1G	S	A	R
S-1206B2J-U3T1G	S	A	S
S-1206B29-U3T1G	S	A	T
S-1206B30-U3T1G	S	A	U
S-1206B31-U3T1G	S	A	V

Product Name	Product Code		
	(1)	(2)	(3)
S-1206B32-U3T1G	S	A	W
S-1206B33-U3T1G	S	A	X
S-1206B34-U3T1G	S	A	Y
S-1206B35-U3T1G	S	A	Z
S-1206B36-U3T1G	S	B	A
S-1206B37-U3T1G	S	B	B
S-1206B38-U3T1G	S	B	C
S-1206B39-U3T1G	S	B	D
S-1206B40-U3T1G	S	B	E
S-1206B41-U3T1G	S	B	F
S-1206B42-U3T1G	S	B	G
S-1206B43-U3T1G	S	B	H
S-1206B44-U3T1G	S	B	I
S-1206B45-U3T1G	S	B	J
S-1206B46-U3T1G	S	B	K
S-1206B47-U3T1G	S	B	L
S-1206B48-U3T1G	S	B	M
S-1206B49-U3T1G	S	B	N
S-1206B50-U3T1G	S	B	O
S-1206B51-U3T1G	S	B	P
S-1206B52-U3T1G	S	B	Q

**Remark** Please contact our sales office for products with output voltage values other than the above.



(3) SNT-6A(H)

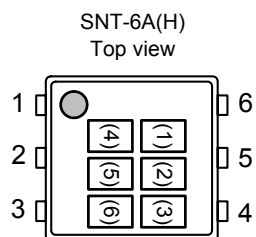

(1) to (3) : Product abbreviation (refer to **Product Name vs. Product Code**)  
 (4) to (6) : Lot number

List of Product Name vs. Product Code

Product Name	Product Code		
	(1)	(2)	(3)
S-1206B12-I6T2G	S	A	A
S-1206B13-I6T2G	S	A	B
S-1206B14-I6T2G	S	A	C
S-1206B15-I6T2G	S	A	D
S-1206B16-I6T2G	S	A	E
S-1206B17-I6T2G	S	A	F
S-1206B18-I6T2G	S	A	G
S-1206B1J-I6T2G	S	A	H
S-1206B19-I6T2G	S	A	I
S-1206B20-I6T2G	S	A	J
S-1206B21-I6T2G	S	A	K
S-1206B22-I6T2G	S	A	L
S-1206B23-I6T2G	S	A	M
S-1206B24-I6T2G	S	A	N
S-1206B25-I6T2G	S	A	O
S-1206B26-I6T2G	S	A	P
S-1206B27-I6T2G	S	A	Q
S-1206B28-I6T2G	S	A	R
S-1206B2J-I6T2G	S	A	S
S-1206B29-I6T2G	S	A	T
S-1206B30-I6T2G	S	A	U
S-1206B31-I6T2G	S	A	V

Product Name	Product Code		
	(1)	(2)	(3)
S-1206B32-I6T2G	S	A	W
S-1206B33-I6T2G	S	A	X
S-1206B34-I6T2G	S	A	Y
S-1206B35-I6T2G	S	A	Z
S-1206B36-I6T2G	S	B	A
S-1206B37-I6T2G	S	B	B
S-1206B38-I6T2G	S	B	C
S-1206B39-I6T2G	S	B	D
S-1206B40-I6T2G	S	B	E
S-1206B41-I6T2G	S	B	F
S-1206B42-I6T2G	S	B	G
S-1206B43-I6T2G	S	B	H
S-1206B44-I6T2G	S	B	I
S-1206B45-I6T2G	S	B	J
S-1206B46-I6T2G	S	B	K
S-1206B47-I6T2G	S	B	L
S-1206B48-I6T2G	S	B	M
S-1206B49-I6T2G	S	B	N
S-1206B50-I6T2G	S	B	O
S-1206B51-I6T2G	S	B	P
S-1206B52-I6T2G	S	B	Q

**Remark** Please contact our sales office for products with output voltage values other than the above.

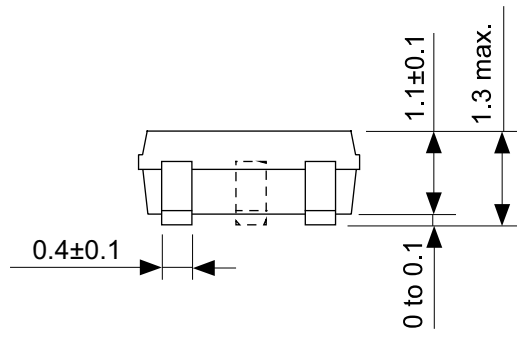
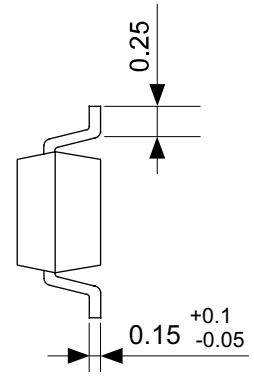
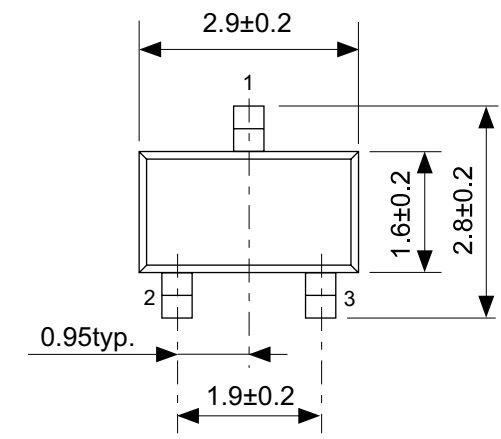

No. MP003-Z-P-SD-1.0

TITLE	SOT233-Z-PKG Dimensions
No.	MP003-Z-P-SD-1.0
SCALE	
UNIT	mm

Seiko Instruments Inc.

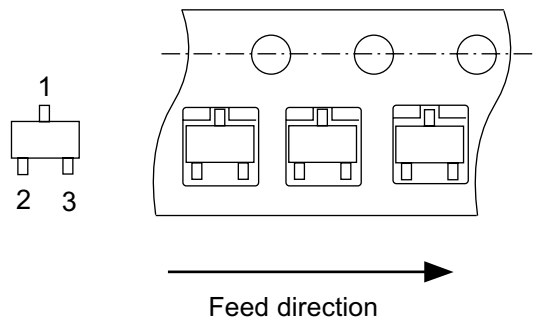
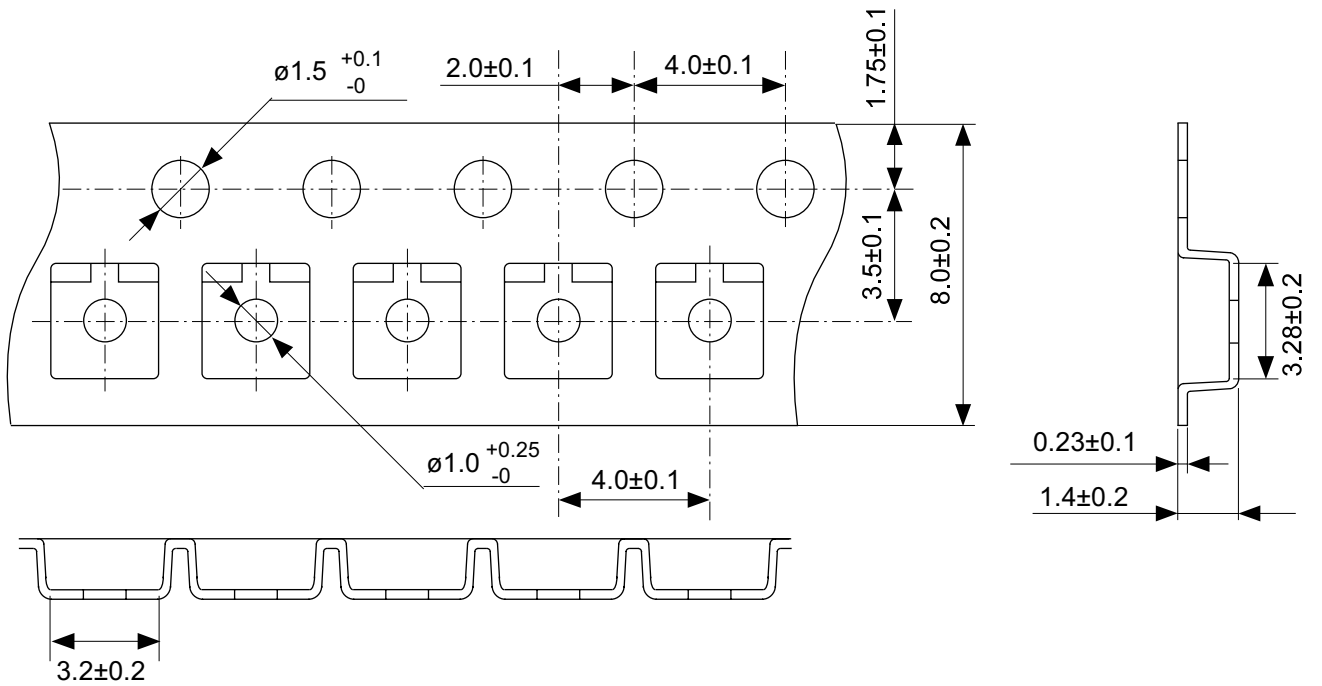

No. MP003-Z-C-SD-1.0

TITLE	SOT233-Z-Carrier Tape
No.	MP003-Z-C-SD-1.0
SCALE	
UNIT	mm
Seiko Instruments Inc.	



Enlarged drawing in the central part

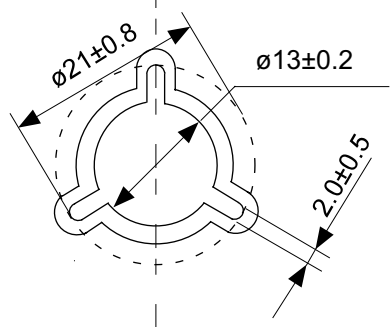

No. MP003-Z-R-SD-1.0

TITLE	SOT233-Z-Reel		
No.	MP003-Z-R-SD-1.0		
SCALE		QTY.	3,000
UNIT	mm		

Seiko Instruments Inc.

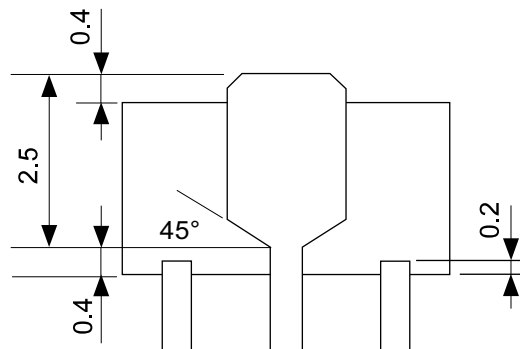
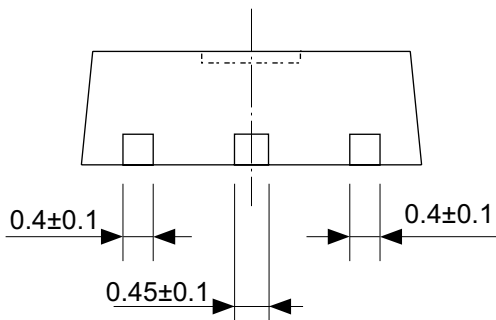
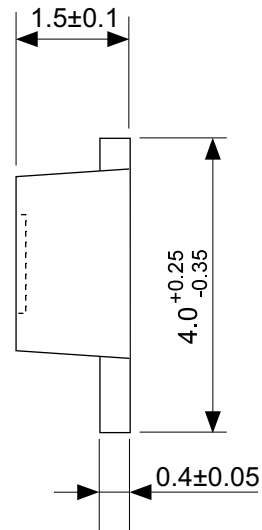
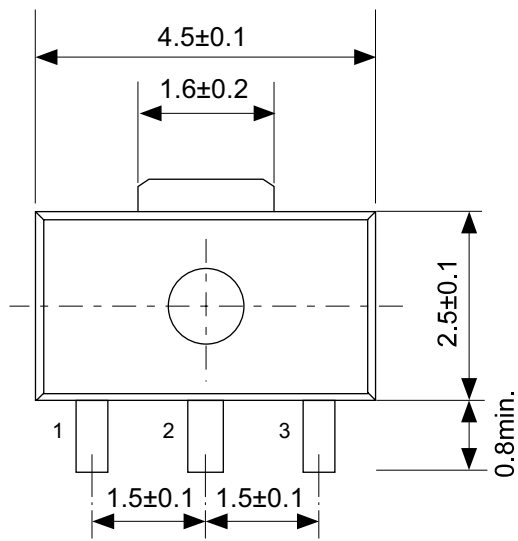

No. UP003-A-P-SD-1.1

TITLE	SOT893-A-PKG Dimensions
No.	UP003-A-P-SD-1.1
SCALE	
UNIT	mm

Seiko Instruments Inc.



→  
Feed direction

No. UP003-A-C-SD-1.1

TITLE	SOT893-A-Carrier Tape
No.	UP003-A-C-SD-1.1
SCALE	
UNIT	mm

Seiko Instruments Inc.



Enlarged drawing in the central part

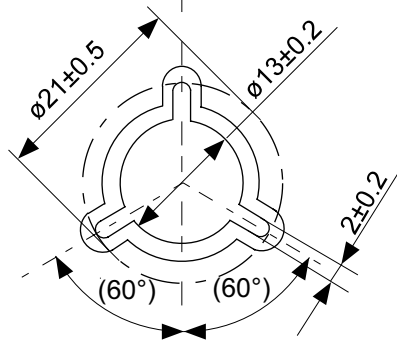

No. UP003-A-R-SD-1.1

TITLE	SOT893-A-Reel		
No.	UP003-A-R-SD-1.1		
SCALE		QTY.	1,000
UNIT	mm		

Seiko Instruments Inc.

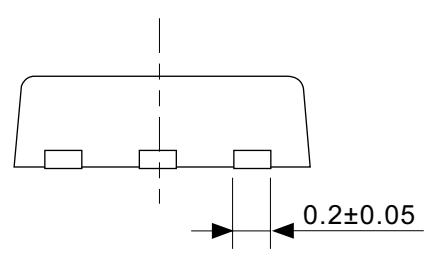
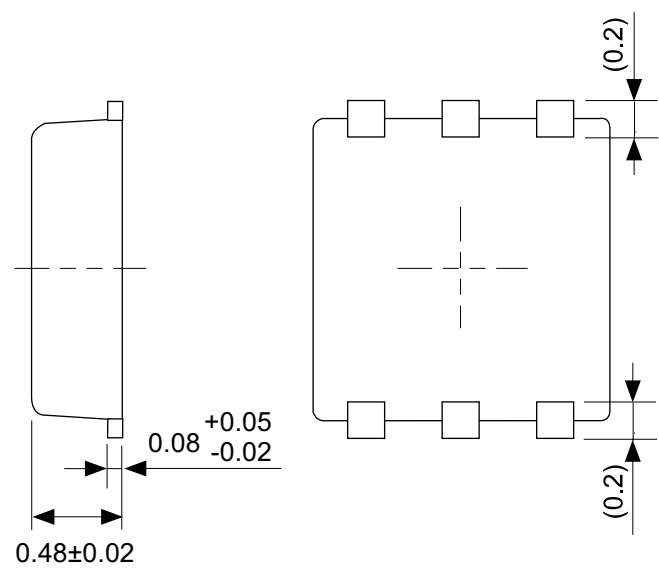
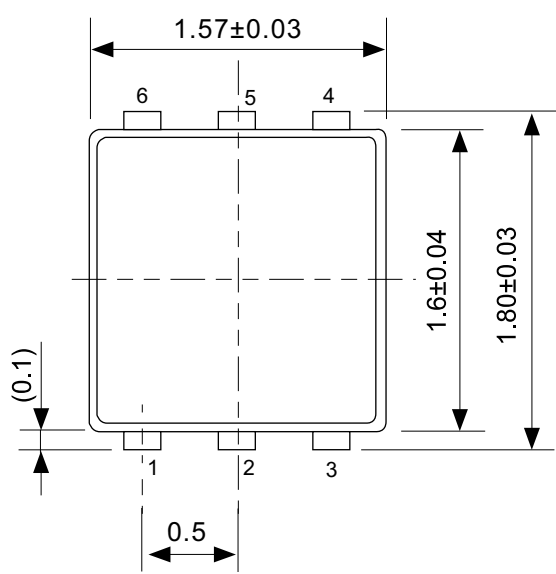

No. PI006-A-P-SD-2.0

TITLE	SNT-6A(H)-A-PKG Dimensions
No.	PI006-A-P-SD-2.0
SCALE	
UNIT	mm
Seiko Instruments Inc.	



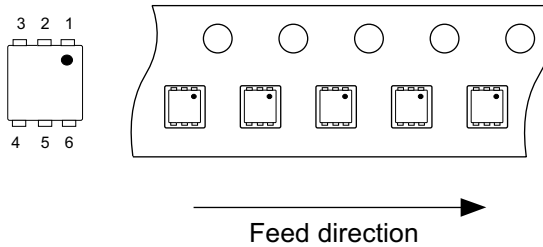

No. PI006-A-C-SD-1.0

TITLE	SNT-6A(H)-A-Carrier Tape
No.	PI006-A-C-SD-1.0
SCALE	
UNIT	mm
Seiko Instruments Inc.	



Enlarged drawing in the central part

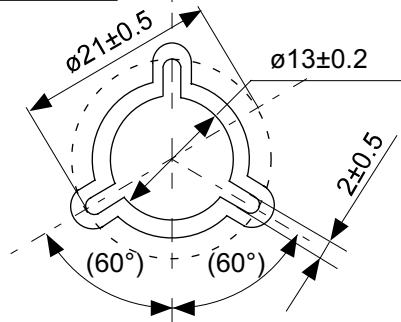

No. PI006-A-R-SD-1.0

TITLE	SNT-6A(H)-A-Reel		
No.	PI006-A-R-SD-1.0		
SCALE		QTY.	5,000
UNIT	mm		
Seiko Instruments Inc.			

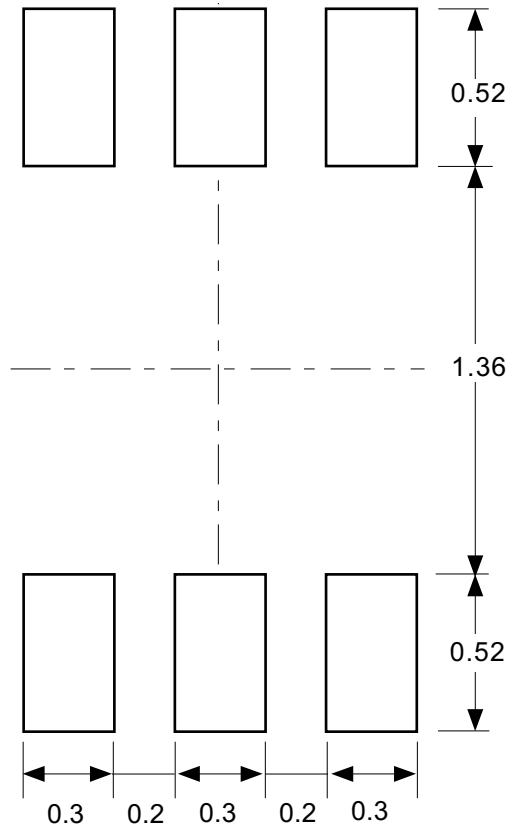

Caution Making the wire pattern under the package is possible. However, note that the package may be upraised due to the thickness made by the silk screen printing and of a solder resist on the pattern because this package does not have the standoff.

注意 パッケージ下への配線パターン形成は可能ですが、本パッケージはスタンドオフが無いので、パターン上のレジスト厚み、シルク印刷の厚みによってパッケージが持ち上がる場合がありますのでご配慮ください。

No. PI006-A-L-SD-3.0

TITLE	SNT-6A(H)-A-Land Recommendation
No.	PI006-A-L-SD-3.0
SCALE	
UNIT	mm
Seiko Instruments Inc.	

- The information described herein is subject to change without notice.
- Seiko Instruments Inc. is not responsible for any problems caused by circuits or diagrams described herein whose related industrial properties, patents, or other rights belong to third parties. The application circuit examples explain typical applications of the products, and do not guarantee the success of any specific mass-production design.
- When the products described herein are regulated products subject to the Wassenaar Arrangement or other agreements, they may not be exported without authorization from the appropriate governmental authority.
- Use of the information described herein for other purposes and/or reproduction or copying without the express permission of Seiko Instruments Inc. is strictly prohibited.
- The products described herein cannot be used as part of any device or equipment affecting the human body, such as exercise equipment, medical equipment, security systems, gas equipment, or any apparatus installed in airplanes and other vehicles, without prior written permission of Seiko Instruments Inc.
- Although Seiko Instruments Inc. exerts the greatest possible effort to ensure high quality and reliability, the failure or malfunction of semiconductor products may occur. The user of these products should therefore give thorough consideration to safety design, including redundancy, fire-prevention measures, and malfunction prevention, to prevent any accidents, fires, or community damage that may ensue.

Компания «Океан Электроники» предлагает заключение долгосрочных отношений при поставках импортных электронных компонентов на взаимовыгодных условиях!

Наши преимущества:

- Поставка оригинальных импортных электронных компонентов напрямую с производств Америки, Европы и Азии, а так же с крупнейших складов мира;
- Широкая линейка поставок активных и пассивных импортных электронных компонентов (более 30 млн. наименований);
- Поставка сложных, дефицитных, либо снятых с производства позиций;
- Оперативные сроки поставки под заказ (от 5 рабочих дней);
- Экспресс доставка в любую точку России;
- Помощь Конструкторского Отдела и консультации квалифицированных инженеров;
- Техническая поддержка проекта, помощь в подборе аналогов, поставка прототипов;
- Поставка электронных компонентов под контролем ВП;
- Система менеджмента качества сертифицирована по Международному стандарту ISO 9001;
- При необходимости вся продукция военного и аэрокосмического назначения проходит испытания и сертификацию в лаборатории (по согласованию с заказчиком);
- Поставка специализированных компонентов военного и аэрокосмического уровня качества (Xilinx, Altera, Analog Devices, Intersil, Interpoint, Microsemi, Actel, Aeroflex, Peregrine, VPT, Syfer, Eurofarad, Texas Instruments, MS Kennedy, Miteq, Cobham, E2V, MA-COM, Hittite, Mini-Circuits, General Dynamics и др.);

Компания «Океан Электроники» является официальным дистрибьютором и эксклюзивным представителем в России одного из крупнейших производителей разъемов военного и аэрокосмического назначения «JONHON», а так же официальным дистрибьютором и эксклюзивным представителем в России производителя высокотехнологичных и надежных решений для передачи СВЧ сигналов «FORSTAR».



## JONHON

«JONHON» (основан в 1970 г.)

Разъемы специального, военного и аэрокосмического назначения:

(Применяются в военной, авиационной, аэрокосмической, морской, железнодорожной, горно- и нефтедобывающей отраслях промышленности)

«FORSTAR» (основан в 1998 г.)

ВЧ соединители, коаксиальные кабели, кабельные сборки и микроволновые компоненты:

(Применяются в телекоммуникациях гражданского и специального назначения, в средствах связи, РЛС, а так же военной, авиационной и аэрокосмической отраслях промышленности).



Телефон: 8 (812) 309-75-97 (многоканальный)

Факс: 8 (812) 320-03-32

Электронная почта: [ocean@oceanchips.ru](mailto:ocean@oceanchips.ru)

Web: <http://oceanchips.ru/>

Адрес: 198099, г. Санкт-Петербург, ул. Калинина, д. 2, корп. 4, лит. А