

Plastic Infrared Emitting Diode

OP140, OP145 Series



Features:

- IR-transmissive plastic package
- Side-looking package for space-limited applications
- Wide irradiance pattern
- Mechanically and spectrally matched to other OPTEK products

Description:

Each device in this series is a high intensity gallium arsenide infrared emitting diode that is suited for use as a PCBoard mounted slotted switch or an easy mount PCBoard interrupter.

Each **OP140** (A, B, C, D) and **OP145** (A, C) device is a domed-lens 935 nm diode that is molded in an IR-transmissive plastic side-looking package.

OP140 is mechanically and spectrally matched to the OP550 series of phototransistors and the OP560 series of photodarlington. OP145 is mechanically and spectrally matched to the OP555 and OP565 series devices.

Please refer to Application Bulletins 208 and 210 for additional design information and reliability (degradation) data.

Applications:

- Space-limited applications
- PCBoard mounted slotted switch
- PCBoard interrupter

Ordering Information				
Part Number	LED Peak Wavelength	Lens Type	Total Beam Angle	Lead Length
OP140A	935 nm	Domed	40°	min of 0.50"
OP140B				
OP140C				
OP140D				
OP145A				
OP145C				



RoHS

General Note

TT Electronics reserves the right to make changes in product specification without notice or liability. All information is subject to TT Electronics' own data and is considered accurate at time of going to print.

OPTEK Technology, Inc.
1645 Wallace Drive, Carrollton, TX 75006 | Ph: +1 972 323 2200
www.optekinc.com | www.ttelectronics.com

Plastic Infrared Emitting Diode

OP140, OP145 Series



OP140 (A, B, C, D)

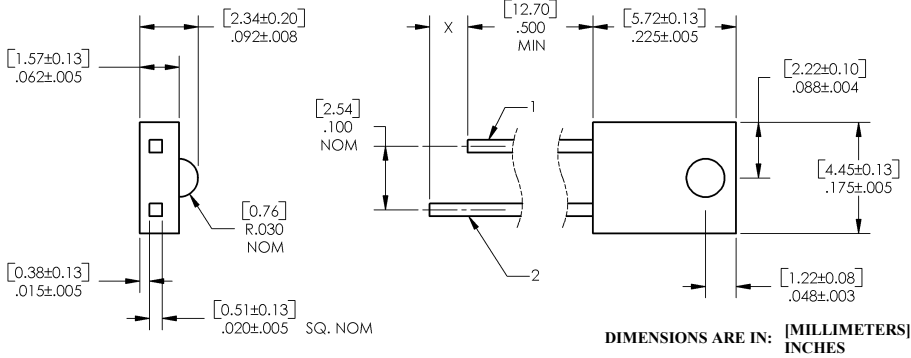

Pin #	LED	Sensor
1	Cathode	Emitter/Anode
2	Anode	Collector/Cathode

OP145 (A, C)

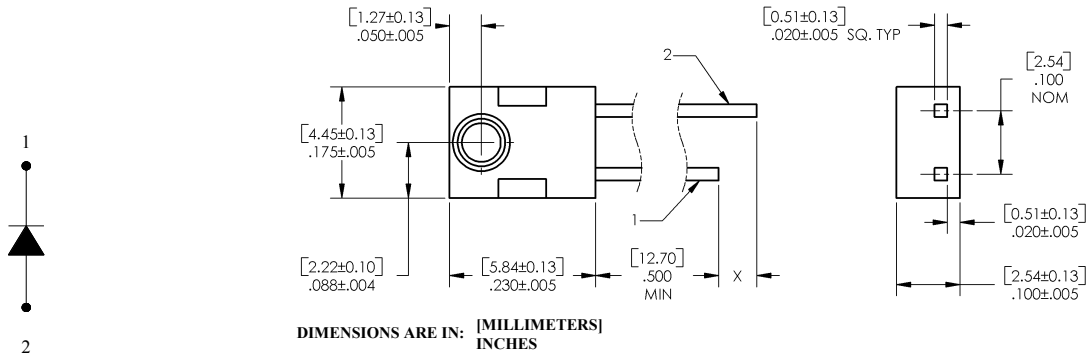

Pin #	LED	Sensor
1	Cathode	Emitter/Anode
2	Anode	Collector/Cathode

CONTAINS POLYSULFONE

To avoid stress cracking, we suggest using ND Industries' **Vibra-Tite** for thread-locking. **Vibra-Tite** evaporates fast without causing structural failure in OPTEK'S molded plastics.

General Note

TT Electronics reserves the right to make changes in product specification without notice or liability. All information is subject to TT Electronics' own data and is considered accurate at time of going to print.

OPTEK Technology, Inc.
1645 Wallace Drive, Carrollton, TX 75006 | Ph: +1 972 323 2200
www.optekinc.com | www.ttelectronics.com

Plastic Infrared Emitting Diode

OP140, OP145 Series



Electrical Specifications

Absolute Maximum Ratings ($T_A = 25^\circ\text{C}$ unless otherwise noted)	
Storage and Operating Temperature Range	-40°C to $+100^\circ\text{C}$
Reverse Voltage	2.0 V
Continuous Forward Current	50 mA
Peak Forward Current	3.0 A
Lead Soldering Temperature [1/16 inch (1.6 mm) from case for 5 seconds with soldering iron] ⁽¹⁾	260°C
Power Dissipation ⁽²⁾	100 mW

Electrical Characteristics ($T_A = 25^\circ\text{C}$ unless otherwise noted)						
SYMBOL	PARAMETER	MIN	TYP	MAX	UNITS	TEST CONDITIONS
Input Diode						
$E_{E(APT)}$	Apertured Radiant Incidence	0.40	-	-	mW/cm ²	$I_F = 20\text{ mA}^{(3)}$
	OP140A, OP145A	0.30	-	0.55		
	OP140B	0.20	-	0.40		
	OP140C, OP145C	0.10	-	-		
V_F	Forward Voltage	-	-	1.60	V	$I_F = 20\text{ mA}$
I_R	Reverse Current	-	-	100	μA	$V_R = 2.0\text{ V}$
λ_p	Wavelength at Peak Emission	-	935	-	nm	$I_F = 10\text{ mA}$
B	Spectral Bandwidth between Half Power Points	-	50	-	nm	$I_F = 10\text{ mA}$
$\lambda_p/\Delta T$	Spectral Shift with Temperature	-	± 0.30	-	nm/ $^\circ\text{C}$	$I_F = \text{Constant}$
θ_{HP}	Emission Angle at Half Power Points	-	40	-	Degree	$I_F = 20\text{ mA}$
t_r	Output Rise Time	-	1000	-	ns	$I_{F(PK)} = 100\text{ mA}$, $PW = 10\ \mu\text{s}$, and $D.C. = 10.0\%$
t_f	Output Fall Time	-	500	-	ns	

- Notes:
1. RMA flux is recommended. Duration can be extended to 10 seconds maximum when flow soldering. A maximum of 20 grams force may be applied to the leads when soldering.
 2. Derate linearly 1.33 mW/ $^\circ\text{C}$ above 25°C .
 3. $E_{E(APT)}$ is a measurement of the average apertured radiant energy incident upon a sensing area 0.180" (4.57 mm) in diameter perpendicular to and centered on the mechanical axis of the lens and 0.653" (6.60 mm) from the lens tip. $E_{E(APT)}$ is not necessarily

General Note

TT Electronics reserves the right to make changes in product specification without notice or liability. All information is subject to TT Electronics' own data and is considered accurate at time of going to print.

OPTEK Technology, Inc.
1645 Wallace Drive, Carrollton, TX 75006 | Ph: +1 972 323 2200
www.optekinc.com | www.ttelectronics.com

Plastic Infrared Emitting Diode

OP140, OP145 Series



Performance

OP140, OP145 (A, B, C, D)

Forward Voltage vs Forward Current vs Temperature

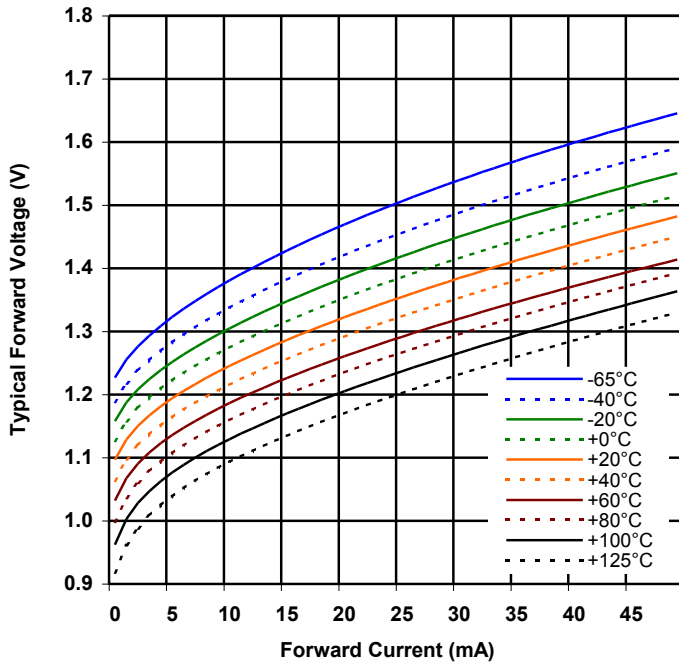

Optical Power vs I_F vs Temp

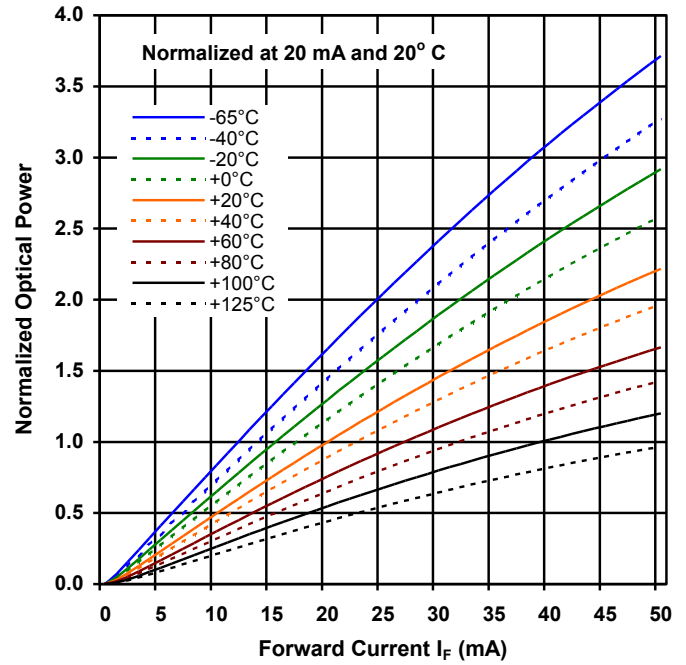

Distance vs Output Power vs Forward Current

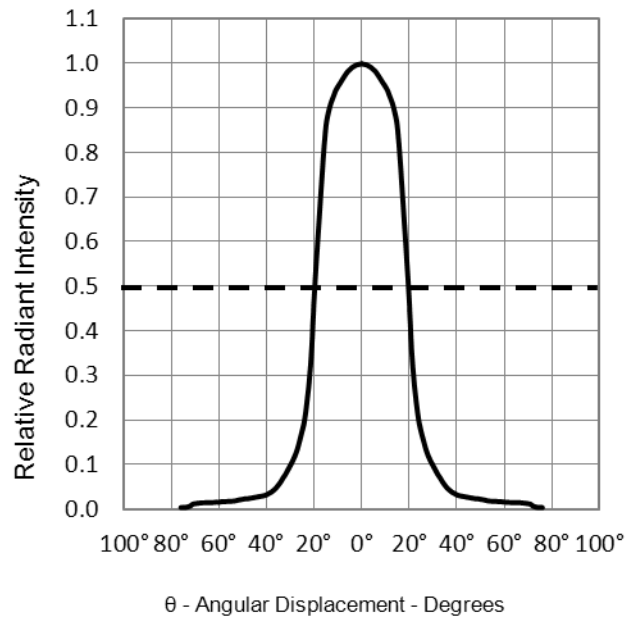
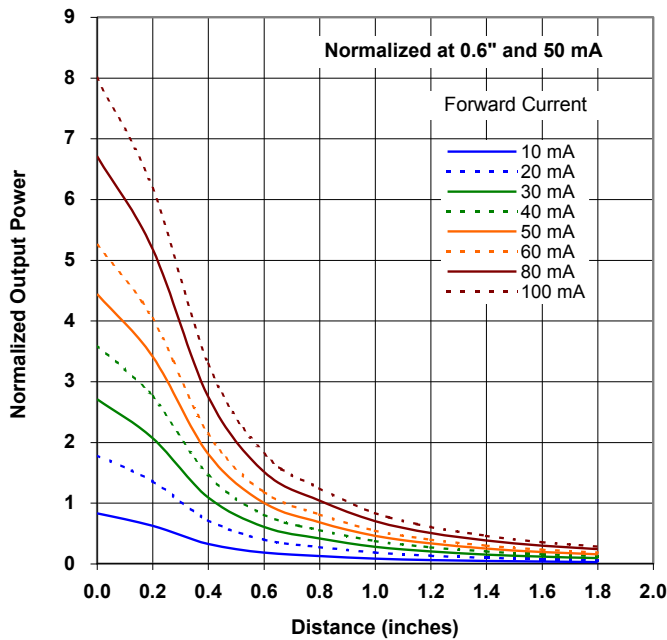

General Note

TT Electronics reserves the right to make changes in product specification without notice or liability. All information is subject to TT Electronics' own data and is considered accurate at time of going to print.

OPTEK Technology, Inc.
1645 Wallace Drive, Carrollton, TX 75006 | Ph: +1 972 323 2200
www.optekinc.com | www.ttelectronics.com

Plastic Infrared Emitting Diode

OP140, OP145 Series



Performance

Degradation curves of OP140 +/- 3 standard deviations
Conditions: $I_f = 20 \text{ mA}$

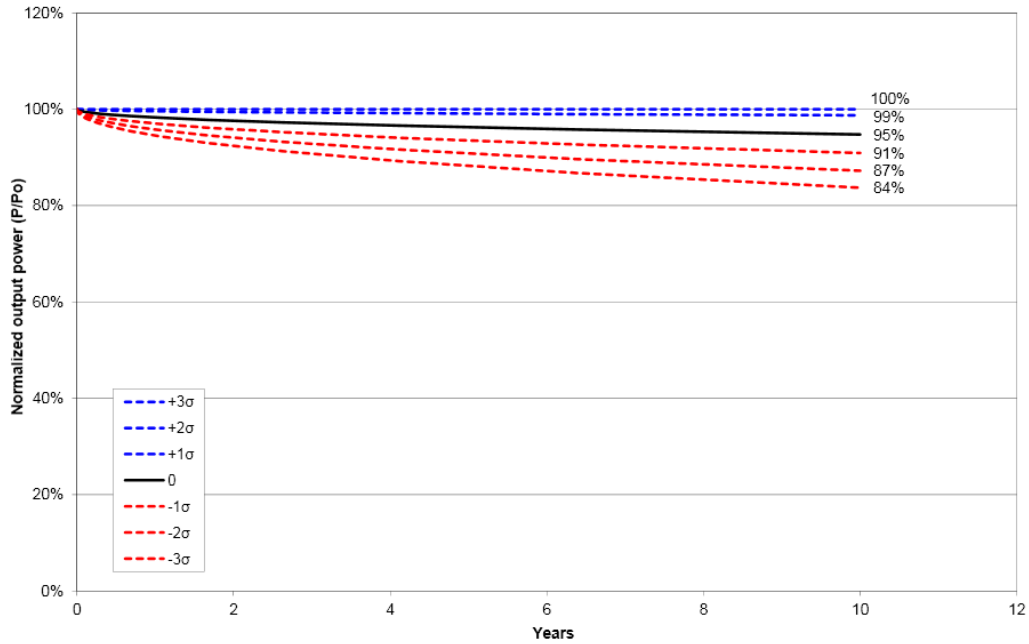

Spectral Response

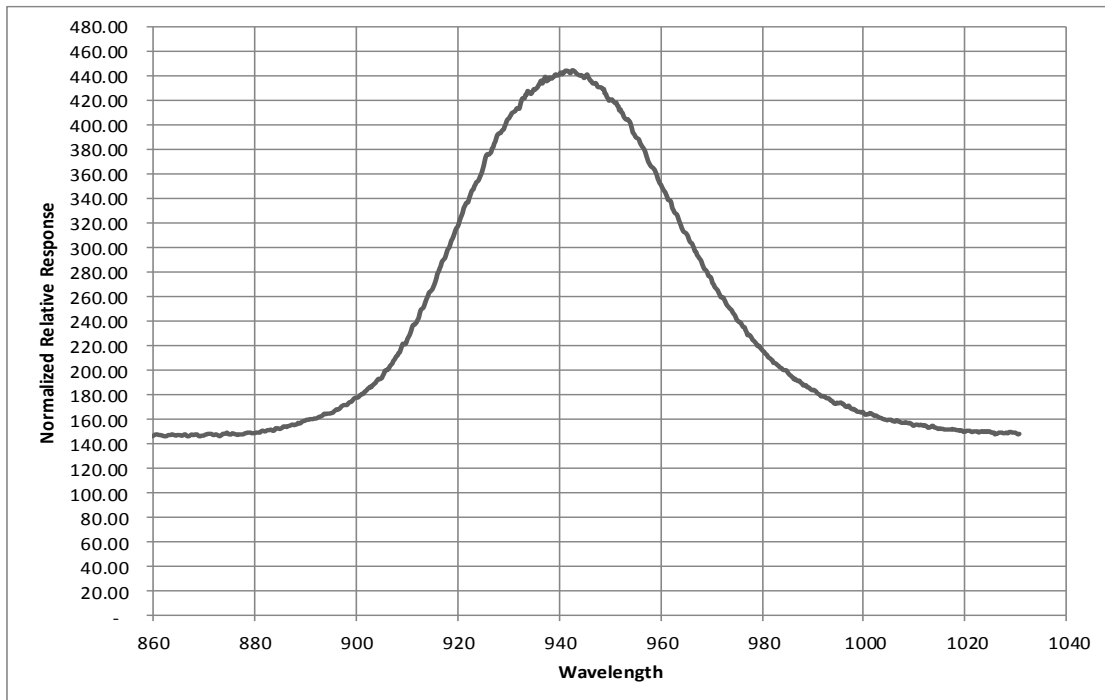

General Note

TT Electronics reserves the right to make changes in product specification without notice or liability. All information is subject to TT Electronics' own data and is considered accurate at time of going to print.

OPTEK Technology, Inc.
1645 Wallace Drive, Carrollton, TX 75006 | Ph: +1 972 323 2200
www.optekinc.com | www.ttelectronics.com

Компания «Океан Электроники» предлагает заключение долгосрочных отношений при поставках импортных электронных компонентов на взаимовыгодных условиях!

Наши преимущества:

- Поставка оригинальных импортных электронных компонентов напрямую с производств Америки, Европы и Азии, а так же с крупнейших складов мира;
- Широкая линейка поставок активных и пассивных импортных электронных компонентов (более 30 млн. наименований);
- Поставка сложных, дефицитных, либо снятых с производства позиций;
- Оперативные сроки поставки под заказ (от 5 рабочих дней);
- Экспресс доставка в любую точку России;
- Помощь Конструкторского Отдела и консультации квалифицированных инженеров;
- Техническая поддержка проекта, помощь в подборе аналогов, поставка прототипов;
- Поставка электронных компонентов под контролем ВП;
- Система менеджмента качества сертифицирована по Международному стандарту ISO 9001;
- При необходимости вся продукция военного и аэрокосмического назначения проходит испытания и сертификацию в лаборатории (по согласованию с заказчиком);
- Поставка специализированных компонентов военного и аэрокосмического уровня качества (Xilinx, Altera, Analog Devices, Intersil, Interpoint, Microsemi, Actel, Aeroflex, Peregrine, VPT, Syfer, Eurofarad, Texas Instruments, MS Kennedy, Miteq, Cobham, E2V, MA-COM, Hittite, Mini-Circuits, General Dynamics и др.);

Компания «Океан Электроники» является официальным дистрибьютором и эксклюзивным представителем в России одного из крупнейших производителей разъемов военного и аэрокосмического назначения «**JONHON**», а так же официальным дистрибьютором и эксклюзивным представителем в России производителя высокотехнологичных и надежных решений для передачи СВЧ сигналов «**FORSTAR**».



JONHON

«**JONHON**» (основан в 1970 г.)

Разъемы специального, военного и аэрокосмического назначения:

(Применяются в военной, авиационной, аэрокосмической, морской, железнодорожной, горно- и нефтедобывающей отраслях промышленности)

«**FORSTAR**» (основан в 1998 г.)

ВЧ соединители, коаксиальные кабели, кабельные сборки и микроволновые компоненты:

(Применяются в телекоммуникациях гражданского и специального назначения, в средствах связи, РЛС, а так же военной, авиационной и аэрокосмической отраслях промышленности).



Телефон: 8 (812) 309-75-97 (многоканальный)

Факс: 8 (812) 320-03-32

Электронная почта: ocean@oceanchips.ru

Web: <http://oceanchips.ru/>

Адрес: 198099, г. Санкт-Петербург, ул. Калинина, д. 2, корп. 4, лит. А