

# CAT24C64

## 64 kb I<sup>2</sup>C CMOS Serial EEPROM

### Description

The CAT24C64 is a 64 kb CMOS Serial EEPROM device, internally organized as 8192 words of 8 bits each.

It features a 32-byte page write buffer and supports the Standard (100 kHz), Fast (400 kHz) and Fast-Plus (1 MHz) I<sup>2</sup>C protocol.

External address pins make it possible to address up to eight CAT24C64 devices on the same bus.

### Features

- Supports Standard, Fast and Fast-Plus I<sup>2</sup>C Protocol
- 1.7 V to 5.5 V Supply Voltage Range
- 32-Byte Page Write Buffer
- Hardware Write Protection for Entire Memory
- Schmitt Triggers and Noise Suppression Filters on I<sup>2</sup>C Bus Inputs (SCL and SDA)
- Low Power CMOS Technology
- 1,000,000 Program/Erase Cycles
- 100 Year Data Retention
- Industrial and Extended Temperature Range
- PDIP, SOIC, TSSOP, MSOP 8-lead and TDFN/UDFN 8-pad Packages
- This Device is Pb-Free, Halogen Free/BFR Free, and RoHS Compliant

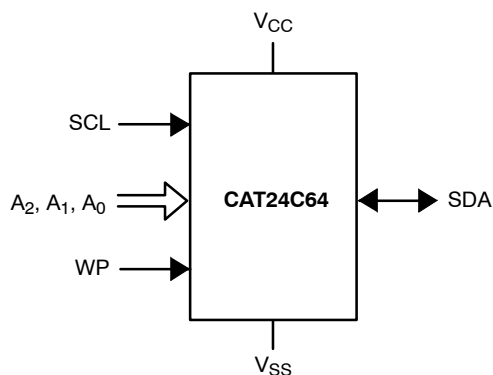

Figure 1. Functional Symbol



**ON Semiconductor®**

<http://onsemi.com>



**SOIC-8  
X SUFFIX  
CASE 751BE**

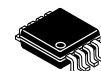

**MSOP-8  
Z SUFFIX  
CASE 846AD**



**SOIC-8  
W SUFFIX  
CASE 751BD**



**UDFN-8  
HU4 SUFFIX  
CASE 517AZ**



**TDFN-8  
VP2 SUFFIX  
CASE 511AK**

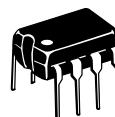

**PDIP-8  
L SUFFIX  
CASE 646AA**

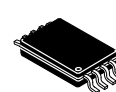

**TSSOP-8  
Y SUFFIX  
CASE 948AL**

### PIN CONFIGURATION

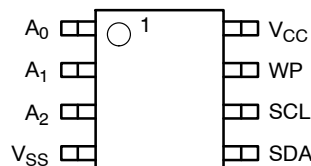

PDIP (L), SOIC (W, X), TSSOP (Y), MSOP (Z), TDFN (VP2), UDFN (HU4)

For the location of Pin 1, please consult the corresponding package drawing.

### PIN FUNCTION

| Pin Name                                         | Function       |
|--------------------------------------------------|----------------|
| A <sub>0</sub> , A <sub>1</sub> , A <sub>2</sub> | Device Address |
| SDA                                              | Serial Data    |
| SCL                                              | Serial Clock   |
| WP                                               | Write Protect  |
| V <sub>CC</sub>                                  | Power Supply   |
| V <sub>SS</sub>                                  | Ground         |

### ORDERING INFORMATION

See detailed ordering and shipping information in the package dimensions section on page 15 of this data sheet.

# CAT24C64

**Table 1. ABSOLUTE MAXIMUM RATINGS**

| Parameters                                         | Ratings      | Units |
|----------------------------------------------------|--------------|-------|
| Storage Temperature                                | -65 to +150  | °C    |
| Voltage on Any Pin with Respect to Ground (Note 1) | -0.5 to +6.5 | V     |

Stresses exceeding Maximum Ratings may damage the device. Maximum Ratings are stress ratings only. Functional operation above the Recommended Operating Conditions is not implied. Extended exposure to stresses above the Recommended Operating Conditions may affect device reliability.

- The DC input voltage on any pin should not be lower than -0.5 V or higher than  $V_{CC} + 0.5$  V. During transitions, the voltage on any pin may undershoot to no less than -1.5 V or overshoot to no more than  $V_{CC} + 1.5$  V, for periods of less than 20 ns.

**Table 2. RELIABILITY CHARACTERISTICS** (Note 2)

| Symbol             | Parameter      | Min       | Units                |
|--------------------|----------------|-----------|----------------------|
| $N_{END}$ (Note 3) | Endurance      | 1,000,000 | Program/Erase Cycles |
| $T_{DR}$           | Data Retention | 100       | Years                |

- These parameters are tested initially and after a design or process change that affects the parameter according to appropriate AEC-Q100 and JEDEC test methods.
- Page Mode,  $V_{CC} = 5$  V, 25°C.

**Table 3. D.C. OPERATING CHARACTERISTICS**

( $V_{CC} = 1.8$  V to 5.5 V,  $T_A = -40$ °C to +125°C and  $V_{CC} = 1.7$  V to 5.5 V,  $T_A = -40$ °C to +85°C, unless otherwise specified.)

| Symbol    | Parameter          | Test Conditions                     | Min                                            | Max                 | Units   |
|-----------|--------------------|-------------------------------------|------------------------------------------------|---------------------|---------|
| $I_{CCR}$ | Read Current       | Read, $f_{SCL} = 400$ kHz           |                                                | 1                   | mA      |
| $I_{CCW}$ | Write Current      | Write, $f_{SCL} = 400$ kHz          |                                                | 2                   | mA      |
| $I_{SB}$  | Standby Current    | All I/O Pins at GND or $V_{CC}$     | $T_A = -40$ °C to +85°C<br>$V_{CC} \leq 3.3$ V | 1                   | $\mu$ A |
|           |                    |                                     | $T_A = -40$ °C to +85°C<br>$V_{CC} > 3.3$ V    | 3                   |         |
|           |                    |                                     | $T_A = -40$ °C to +125°C                       | 5                   |         |
| $I_L$     | I/O Pin Leakage    | Pin at GND or $V_{CC}$              |                                                | 2                   | $\mu$ A |
| $V_{IL}$  | Input Low Voltage  |                                     | -0.5                                           | $V_{CC} \times 0.3$ | V       |
| $V_{IH}$  | Input High Voltage |                                     | $V_{CC} \times 0.7$                            | $V_{CC} + 0.5$      | V       |
| $V_{OL1}$ | Output Low Voltage | $V_{CC} < 2.5$ V, $I_{OL} = 3.0$ mA |                                                | 0.4                 | V       |
| $V_{OL2}$ | Output Low Voltage | $V_{CC} < 2.5$ V, $I_{OL} = 1.0$ mA |                                                | 0.2                 | V       |

**Table 4. PIN IMPEDANCE CHARACTERISTICS**

( $V_{CC} = 1.8$  V to 5.5 V,  $T_A = -40$ °C to +125°C and  $V_{CC} = 1.7$  V to 5.5 V,  $T_A = -40$ °C to +85°C, unless otherwise specified.)

| Symbol            | Parameter                                              | Conditions                           | Max | Units   |
|-------------------|--------------------------------------------------------|--------------------------------------|-----|---------|
| $C_{IN}$ (Note 4) | SDA I/O Pin Capacitance                                | $V_{IN} = 0$ V                       | 8   | pF      |
| $C_{IN}$ (Note 4) | Input Capacitance (other pins)                         | $V_{IN} = 0$ V                       | 6   | pF      |
| $I_{WP}$ (Note 5) | WP Input Current                                       | $V_{IN} < V_{IH}$ , $V_{CC} = 5.5$ V | 130 | $\mu$ A |
|                   |                                                        | $V_{IN} < V_{IH}$ , $V_{CC} = 3.3$ V | 120 |         |
|                   |                                                        | $V_{IN} < V_{IH}$ , $V_{CC} = 1.8$ V | 80  |         |
|                   |                                                        | $V_{IN} > V_{IH}$                    | 2   |         |
| $I_A$ (Note 5)    | Address Input Current<br>(A0, A1, A2)<br>Product Rev F | $V_{IN} < V_{IH}$ , $V_{CC} = 5.5$ V | 50  | $\mu$ A |
|                   |                                                        | $V_{IN} < V_{IH}$ , $V_{CC} = 3.3$ V | 35  |         |
|                   |                                                        | $V_{IN} < V_{IH}$ , $V_{CC} = 1.8$ V | 25  |         |
|                   |                                                        | $V_{IN} > V_{IH}$                    | 2   |         |

- These parameters are tested initially and after a design or process change that affects the parameter according to appropriate AEC-Q100 and JEDEC test methods.
- When not driven, the WP, A0, A1 and A2 pins are pulled down to GND internally. For improved noise immunity, the internal pull-down is relatively strong; therefore the external driver must be able to supply the pull-down current when attempting to drive the input HIGH. To conserve power, as the input level exceeds the trip point of the CMOS input buffer ( $\sim 0.5 \times V_{CC}$ ), the strong pull-down reverts to a weak current source.

# CAT24C64

**Table 5. A.C. CHARACTERISTICS**

( $V_{CC} = 1.8\text{ V to }5.5\text{ V}$ ,  $T_A = -40^\circ\text{C to }+125^\circ\text{C}$  and  $V_{CC} = 1.7\text{ V to }5.5\text{ V}$ ,  $T_A = -40^\circ\text{C to }+85^\circ\text{C}$ .) (Note 6)

| Symbol                | Parameter                                  | Standard<br>$V_{CC} = 1.7\text{ V} - 5.5\text{ V}$ |       | Fast<br>$V_{CC} = 1.7\text{ V} - 5.5\text{ V}$ |     | Fast-Plus (Note 9)<br>$V_{CC} = 2.5\text{ V} - 5.5\text{ V}$<br>$T_A = -40^\circ\text{C to }+85^\circ\text{C}$ |       | Units         |
|-----------------------|--------------------------------------------|----------------------------------------------------|-------|------------------------------------------------|-----|----------------------------------------------------------------------------------------------------------------|-------|---------------|
|                       |                                            | Min                                                | Max   | Min                                            | Max | Min                                                                                                            | Max   |               |
| $F_{SCL}$             | Clock Frequency                            |                                                    | 100   |                                                | 400 |                                                                                                                | 1,000 | kHz           |
| $t_{HD:STA}$          | START Condition Hold Time                  | 4                                                  |       | 0.6                                            |     | 0.25                                                                                                           |       | $\mu\text{s}$ |
| $t_{LOW}$             | Low Period of SCL Clock                    | 4.7                                                |       | 1.3                                            |     | 0.45                                                                                                           |       | $\mu\text{s}$ |
| $t_{HIGH}$            | High Period of SCL Clock                   | 4                                                  |       | 0.6                                            |     | 0.40                                                                                                           |       | $\mu\text{s}$ |
| $t_{SU:STA}$          | START Condition Setup Time                 | 4.7                                                |       | 0.6                                            |     | 0.25                                                                                                           |       | $\mu\text{s}$ |
| $t_{HD:DAT}$          | Data In Hold Time                          | 0                                                  |       | 0                                              |     | 0                                                                                                              |       | $\mu\text{s}$ |
| $t_{SU:DAT}$          | Data In Setup Time                         | 250                                                |       | 100                                            |     | 50                                                                                                             |       | ns            |
| $t_R$ (Note 7)        | SDA and SCL Rise Time                      |                                                    | 1,000 |                                                | 300 |                                                                                                                | 100   | ns            |
| $t_F$ (Note 7)        | SDA and SCL Fall Time                      |                                                    | 300   |                                                | 300 |                                                                                                                | 100   | ns            |
| $t_{SU:STO}$          | STOP Condition Setup Time                  | 4                                                  |       | 0.6                                            |     | 0.25                                                                                                           |       | $\mu\text{s}$ |
| $t_{BUF}$             | Bus Free Time Between STOP and START       | 4.7                                                |       | 1.3                                            |     | 0.5                                                                                                            |       | $\mu\text{s}$ |
| $t_{AA}$              | SCL Low to Data Out Valid                  |                                                    | 3.5   |                                                | 0.9 |                                                                                                                | 0.40  | $\mu\text{s}$ |
| $t_{DH}$              | Data Out Hold Time                         | 100                                                |       | 100                                            |     | 50                                                                                                             |       | ns            |
| $T_i$ (Note 7)        | Noise Pulse Filtered at SCL and SDA Inputs |                                                    | 100   |                                                | 100 |                                                                                                                | 100   | ns            |
| $t_{SU:WP}$           | WP Setup Time                              | 0                                                  |       | 0                                              |     | 0                                                                                                              |       | $\mu\text{s}$ |
| $t_{HD:WP}$           | WP Hold Time                               | 2.5                                                |       | 2.5                                            |     | 1                                                                                                              |       | $\mu\text{s}$ |
| $t_{WR}$              | Write Cycle Time                           |                                                    | 5     |                                                | 5   |                                                                                                                | 5     | ms            |
| $t_{PU}$ (Notes 7, 8) | Power-up to Ready Mode                     |                                                    | 1     |                                                | 1   | 0.1                                                                                                            | 1     | ms            |

6. Test conditions according to "A.C. Test Conditions" table.

7. Tested initially and after a design or process change that affects this parameter.

8.  $t_{PU}$  is the delay between the time  $V_{CC}$  is stable and the device is ready to accept commands.

9. Fast-Plus (1 MHz) speed class available for product revision "F". The die revision "F" is identified by letter "F" or a dedicated marking code on top of the package.

**Table 6. A.C. TEST CONDITIONS**

|                           |                                                                                                                                                  |
|---------------------------|--------------------------------------------------------------------------------------------------------------------------------------------------|
| Input Levels              | $0.2 \times V_{CC}$ to $0.8 \times V_{CC}$                                                                                                       |
| Input Rise and Fall Times | $\leq 50\text{ ns}$                                                                                                                              |
| Input Reference Levels    | $0.3 \times V_{CC}$ , $0.7 \times V_{CC}$                                                                                                        |
| Output Reference Levels   | $0.5 \times V_{CC}$                                                                                                                              |
| Output Load               | Current Source: $I_{OL} = 3\text{ mA}$ ( $V_{CC} \geq 2.5\text{ V}$ ); $I_{OL} = 1\text{ mA}$ ( $V_{CC} < 2.5\text{ V}$ ); $C_L = 100\text{ pF}$ |

**Power-On Reset (POR)**

Each CAT24C64 incorporates Power-On Reset (POR) circuitry which protects the internal logic against powering up in the wrong state. The device will power up into Standby mode after  $V_{CC}$  exceeds the POR trigger level and will power down into Reset mode when  $V_{CC}$  drops below the POR trigger level. This bi-directional POR behavior protects the device against ‘brown-out’ failure following a temporary loss of power.

**Pin Description**

**SCL:** The Serial Clock input pin accepts the clock signal generated by the Master.

**SDA:** The Serial Data I/O pin accepts input data and delivers output data. In transmit mode, this pin is open drain. Data is acquired on the positive edge, and is delivered on the negative edge of SCL.

**A<sub>0</sub>, A<sub>1</sub> and A<sub>2</sub>:** The Address inputs set the device address that must be matched by the corresponding Slave address bits. The Address inputs are hard-wired HIGH or LOW allowing for up to eight devices to be used (cascaded) on the same bus. When left floating, these pins are pulled LOW internally.

**WP:** When pulled HIGH, the Write Protect input pin inhibits all write operations. When left floating, this pin is pulled LOW internally.

**Functional Description**

The CAT24C64 supports the Inter-Integrated Circuit (I<sup>2</sup>C) Bus protocol. The protocol relies on the use of a Master device, which provides the clock and directs bus traffic, and Slave devices which execute requests. The CAT24C64 operates as a Slave device. Both Master and Slave can transmit or receive, but only the Master can assign those roles.

**I<sup>2</sup>C Bus Protocol**

The 2-wire I<sup>2</sup>C bus consists of two lines, SCL and SDA, connected to the  $V_{CC}$  supply via pull-up resistors. The Master provides the clock to the SCL line, and either the Master or the Slaves drive the SDA line. A ‘0’ is transmitted by pulling a line LOW and a ‘1’ by letting it stay HIGH. Data transfer may be initiated only when the bus is not busy (see A.C. Characteristics). During data transfer, SDA must remain stable while SCL is HIGH.

**START/STOP Condition**

An SDA transition while SCL is HIGH creates a START or STOP condition (Figure 2). The START consists of a HIGH to LOW SDA transition, while SCL is HIGH. Absent the START, a Slave will not respond to the Master. The STOP completes all commands, and consists of a LOW to HIGH SDA transition, while SCL is HIGH.

**Device Addressing**

The Master addresses a Slave by creating a START condition and then broadcasting an 8-bit Slave address. For the CAT24C64, the first four bits of the Slave address are set to 1010 (Ah); the next three bits, A<sub>2</sub>, A<sub>1</sub> and A<sub>0</sub>, must match the logic state of the similarly named input pins. The R/W bit tells the Slave whether the Master intends to read (1) or write (0) data (Figure 3).

**Acknowledge**

During the 9<sup>th</sup> clock cycle following every byte sent to the bus, the transmitter releases the SDA line, allowing the receiver to respond. The receiver then either acknowledges (ACK) by pulling SDA LOW, or does not acknowledge (NoACK) by letting SDA stay HIGH (Figure 4). Bus timing is illustrated in Figure 5.

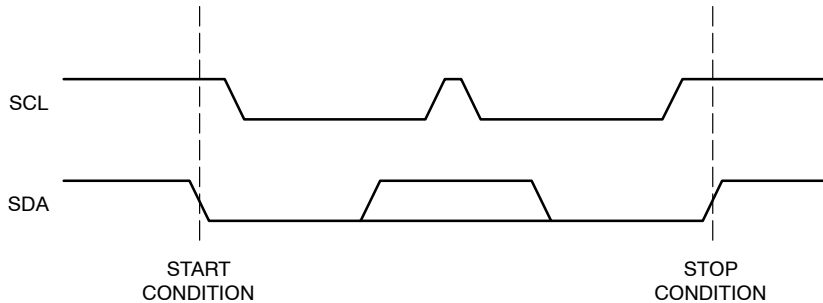

**Figure 2. Start/Stop Timing**

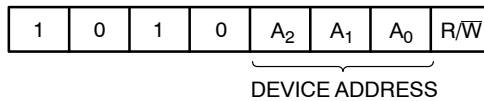

**Figure 3. Slave Address Bits**

## CAT24C64

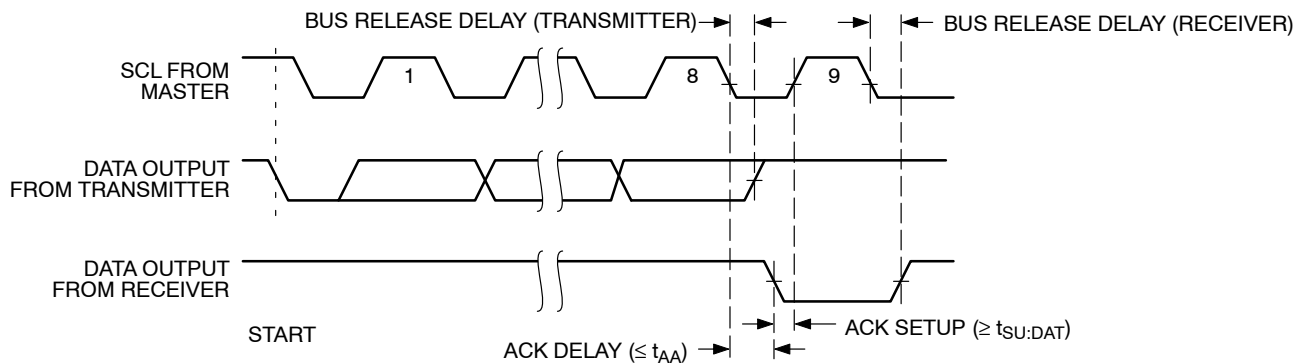

Figure 4. Acknowledge Timing

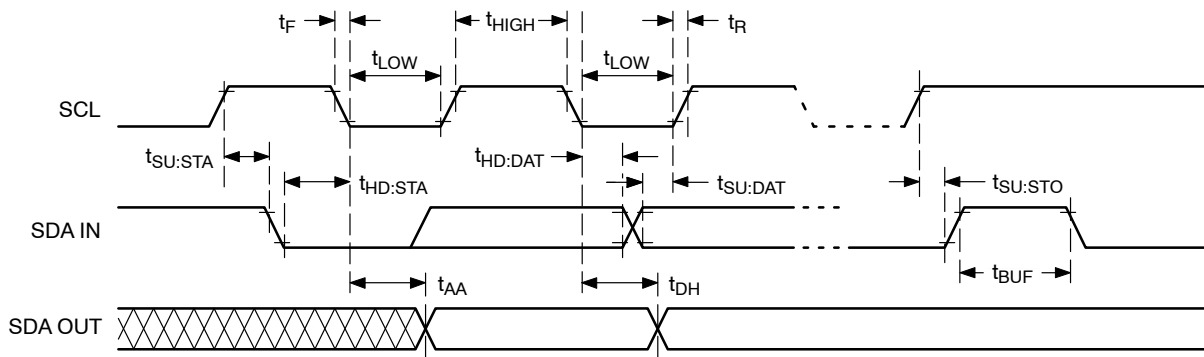

Figure 5. Bus Timing

## WRITE OPERATIONS

### Byte Write

To write data to memory, the Master creates a START condition on the bus and then broadcasts a Slave address with the  $R/\overline{W}$  bit set to '0'. The Master then sends two address bytes and a data byte and concludes the session by creating a STOP condition on the bus. The Slave responds with ACK after every byte sent by the Master (Figure 6). The STOP starts the internal Write cycle, and while this operation is in progress ( $t_{WR}$ ), the SDA output is tri-stated and the Slave does not acknowledge the Master (Figure 7).

### Page Write

The Byte Write operation can be expanded to Page Write, by sending more than one data byte to the Slave before issuing the STOP condition (Figure 8). Up to 32 (Note 10) distinct data bytes can be loaded into the internal Page Write Buffer starting at the address provided by the Master. The page address is latched, and as long as the Master keeps sending data, the internal byte address is incremented up to the end of page, where it then wraps around (within the page). New data can therefore replace data loaded earlier. Following the STOP, data loaded during the Page Write session will be written to memory in a single internal Write cycle ( $t_{WR}$ ).

### Acknowledge Polling

As soon (and as long) as internal Write is in progress, the Slave will not acknowledge the Master. This feature enables the Master to immediately follow-up with a new Read or Write request, rather than wait for the maximum specified Write time ( $t_{WR}$ ) to elapse. Upon receiving a NoACK response from the Slave, the Master simply repeats the request until the Slave responds with ACK.

### Hardware Write Protection

With the WP pin held HIGH, the entire memory is protected against Write operations. If the WP pin is left floating or is grounded, it has no impact on the Write operation. The state of the WP pin is strobed on the last falling edge of SCL immediately preceding the 1<sup>st</sup> data byte (Figure 9). If the WP pin is HIGH during the strobe interval, the Slave will not acknowledge the data byte and the Write request will be rejected.

### Delivery State

The CAT24C64 is shipped erased, i.e., all bytes are FFh.

10. CAT24C64 Rev. D (Not Recommended for New Designs) has 64-Byte Page Write Buffer.

# CAT24C64

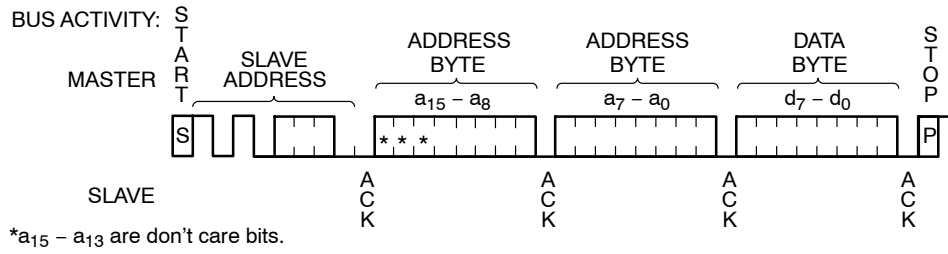

**Figure 6. Byte Write Sequence**

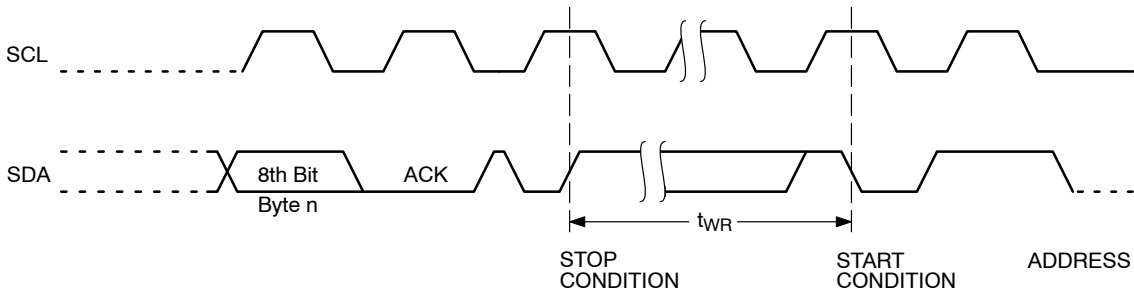

**Figure 7. Write Cycle Timing**

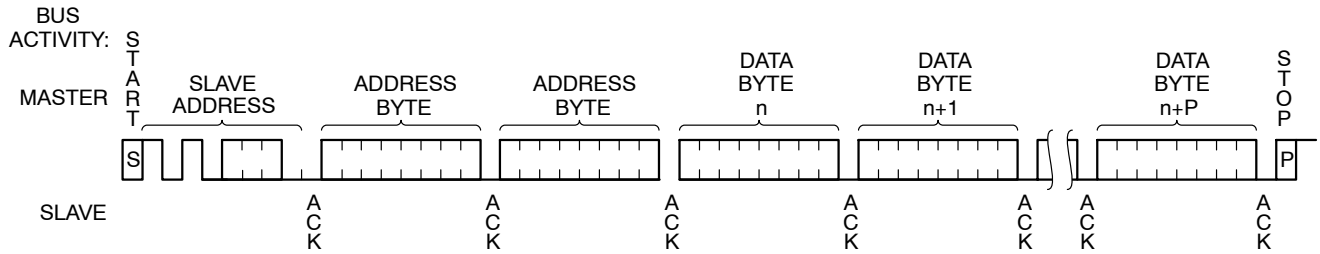

**Figure 8. Page Write Sequence**

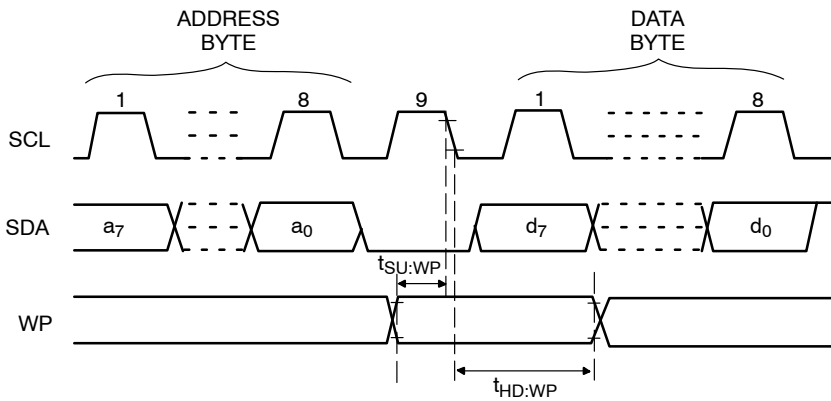

**Figure 9. WP Timing**

**READ OPERATIONS**

**Immediate Read**

To read data from memory, the Master creates a START condition on the bus and then broadcasts a Slave address with the  $R/\overline{W}$  bit set to '1'. The Slave responds with ACK and starts shifting out data residing at the current address. After receiving the data, the Master responds with NoACK and terminates the session by creating a STOP condition on the bus (Figure 10). The Slave then returns to Standby mode.

**Selective Read**

To read data residing at a specific address, the selected address must first be loaded into the internal address register. This is done by starting a Byte Write sequence, whereby the Master creates a START condition, then broadcasts a Slave address with the  $R/\overline{W}$  bit set to '0' and then sends two address bytes to the Slave. Rather than completing the Byte

Write sequence by sending data, the Master then creates a START condition and broadcasts a Slave address with the  $R/\overline{W}$  bit set to '1'. The Slave responds with ACK after every byte sent by the Master and then sends out data residing at the selected address. After receiving the data, the Master responds with NoACK and then terminates the session by creating a STOP condition on the bus (Figure 11).

**Sequential Read**

If, after receiving data sent by the Slave, the Master responds with ACK, then the Slave will continue transmitting until the Master responds with NoACK followed by STOP (Figure 12). During Sequential Read the internal byte address is automatically incremented up to the end of memory, where it then wraps around to the beginning of memory.

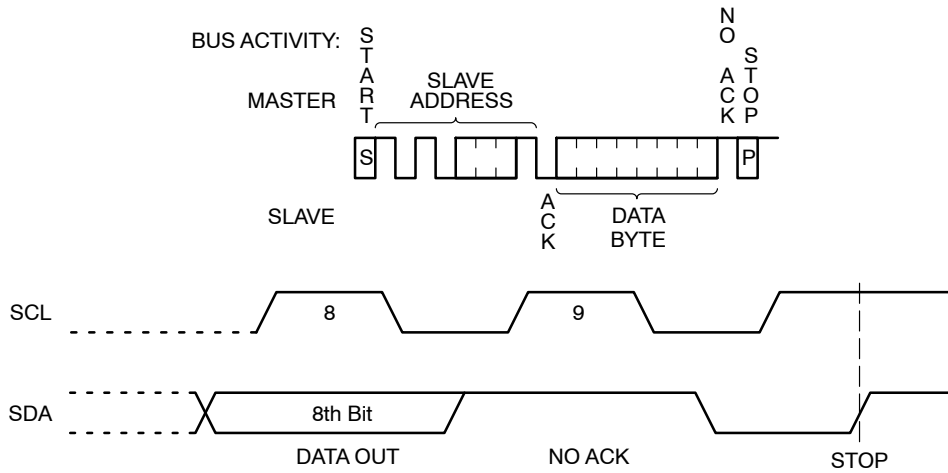

**Figure 10. Immediate Read Sequence and Timing**

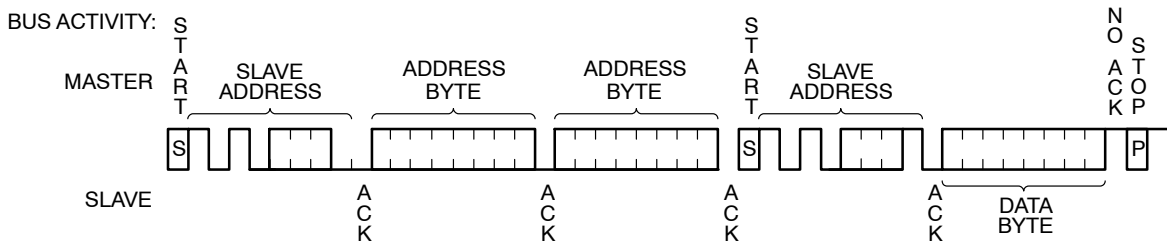

**Figure 11. Selective Read Sequence**

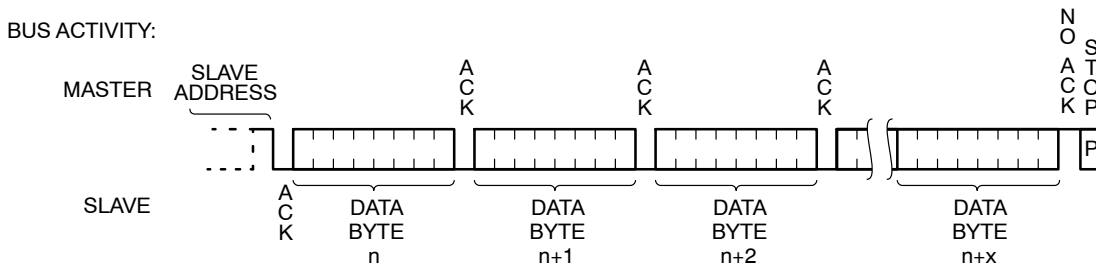
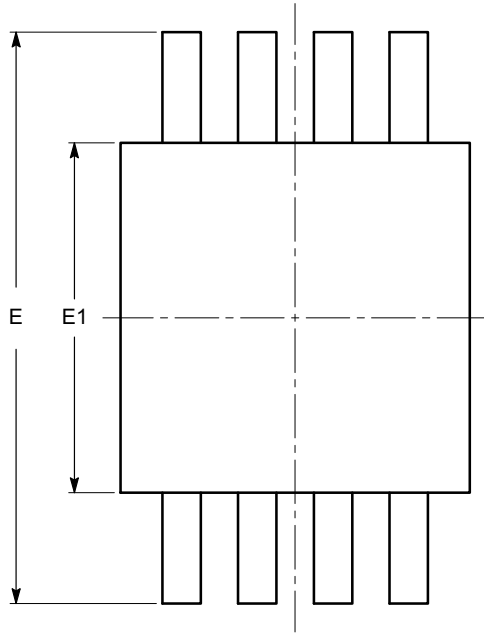

**Figure 12. Sequential Read Sequence**

# CAT24C64

## PACKAGE DIMENSIONS

MSOP 8, 3x3  
CASE 846AD-01  
ISSUE O



TOP VIEW

| SYMBOL   | MIN      | NOM  | MAX  |
|----------|----------|------|------|
| A        |          |      | 1.10 |
| A1       | 0.05     | 0.10 | 0.15 |
| A2       | 0.75     | 0.85 | 0.95 |
| b        | 0.22     |      | 0.38 |
| c        | 0.13     |      | 0.23 |
| D        | 2.90     | 3.00 | 3.10 |
| E        | 4.80     | 4.90 | 5.00 |
| E1       | 2.90     | 3.00 | 3.10 |
| e        | 0.65 BSC |      |      |
| L        | 0.40     | 0.60 | 0.80 |
| L1       | 0.95 REF |      |      |
| L2       | 0.25 BSC |      |      |
| $\theta$ | 0°       |      | 6°   |

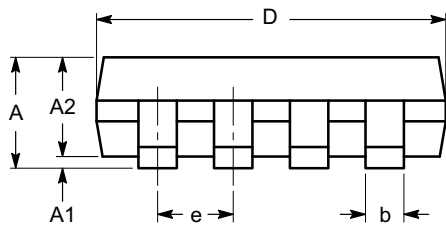

SIDE VIEW

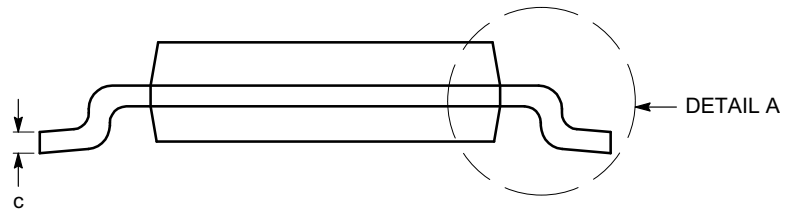

END VIEW

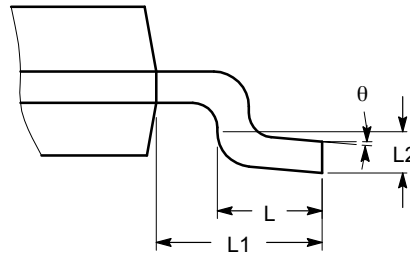

DETAIL A

**Notes:**

- (1) All dimensions are in millimeters. Angles in degrees.
- (2) Complies with JEDEC MO-187.



# CAT24C64

## PACKAGE DIMENSIONS

PDIP-8, 300 mils  
CASE 646AA-01  
ISSUE A



| SYMBOL | MIN      | NOM  | MAX   |
|--------|----------|------|-------|
| A      |          |      | 5.33  |
| A1     | 0.38     |      |       |
| A2     | 2.92     | 3.30 | 4.95  |
| b      | 0.36     | 0.46 | 0.56  |
| b2     | 1.14     | 1.52 | 1.78  |
| c      | 0.20     | 0.25 | 0.36  |
| D      | 9.02     | 9.27 | 10.16 |
| E      | 7.62     | 7.87 | 8.25  |
| E1     | 6.10     | 6.35 | 7.11  |
| e      | 2.54 BSC |      |       |
| eB     | 7.87     |      | 10.92 |
| L      | 2.92     | 3.30 | 3.80  |

TOP VIEW



SIDE VIEW



END VIEW

**Notes:**

- (1) All dimensions are in millimeters.
- (2) Complies with JEDEC MS-001.

# CAT24C64

## PACKAGE DIMENSIONS

SOIC 8, 150 mils  
CASE 751BD-01  
ISSUE O



TOP VIEW

| SYMBOL   | MIN      | NOM | MAX  |
|----------|----------|-----|------|
| A        | 1.35     |     | 1.75 |
| A1       | 0.10     |     | 0.25 |
| b        | 0.33     |     | 0.51 |
| c        | 0.19     |     | 0.25 |
| D        | 4.80     |     | 5.00 |
| E        | 5.80     |     | 6.20 |
| E1       | 3.80     |     | 4.00 |
| e        | 1.27 BSC |     |      |
| h        | 0.25     |     | 0.50 |
| L        | 0.40     |     | 1.27 |
| $\theta$ | 0°       |     | 8°   |



SIDE VIEW



END VIEW

**Notes:**

- (1) All dimensions are in millimeters. Angles in degrees.
- (2) Complies with JEDEC MS-012.

# CAT24C64

## PACKAGE DIMENSIONS

SOIC-8, 208 mils  
CASE 751BE-01  
ISSUE O

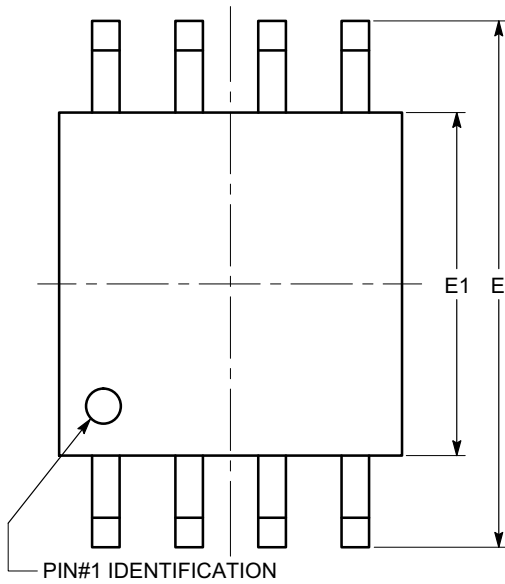

TOP VIEW

| SYMBOL   | MIN      | NOM | MAX  |
|----------|----------|-----|------|
| A        |          |     | 2.03 |
| A1       | 0.05     |     | 0.25 |
| b        | 0.36     |     | 0.48 |
| c        | 0.19     |     | 0.25 |
| D        | 5.13     |     | 5.33 |
| E        | 7.75     |     | 8.26 |
| E1       | 5.13     |     | 5.38 |
| e        | 1.27 BSC |     |      |
| L        | 0.51     |     | 0.76 |
| $\theta$ | 0°       |     | 8°   |

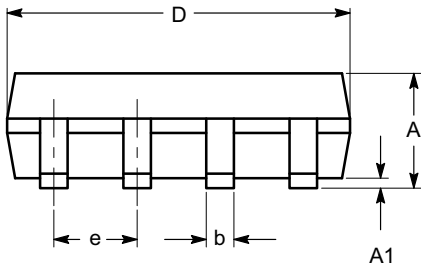

SIDE VIEW

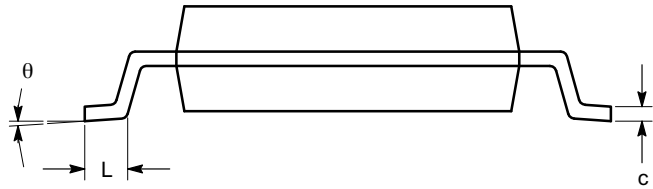

END VIEW

**Notes:**

- (1) All dimensions are in millimeters. Angles in degrees.
- (2) Complies with EIAJ EDR-7320.

# CAT24C64

## PACKAGE DIMENSIONS

TSSOP8, 4.4x3  
CASE 948AL-01  
ISSUE O

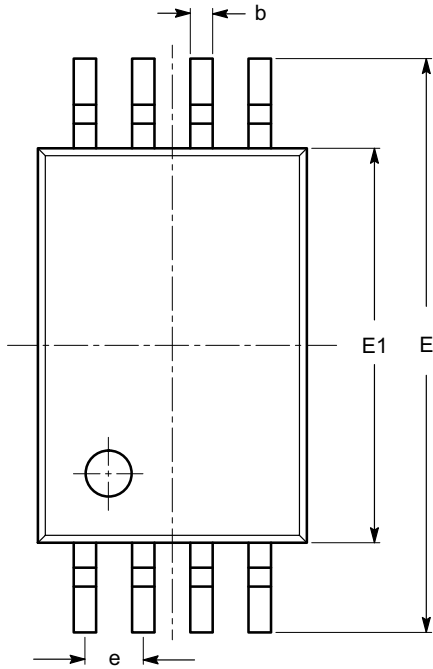

| SYMBOL   | MIN      | NOM  | MAX  |
|----------|----------|------|------|
| A        |          |      | 1.20 |
| A1       | 0.05     |      | 0.15 |
| A2       | 0.80     | 0.90 | 1.05 |
| b        | 0.19     |      | 0.30 |
| c        | 0.09     |      | 0.20 |
| D        | 2.90     | 3.00 | 3.10 |
| E        | 6.30     | 6.40 | 6.50 |
| E1       | 4.30     | 4.40 | 4.50 |
| e        | 0.65 BSC |      |      |
| L        | 1.00 REF |      |      |
| L1       | 0.50     | 0.60 | 0.75 |
| $\theta$ | 0°       |      | 8°   |

TOP VIEW

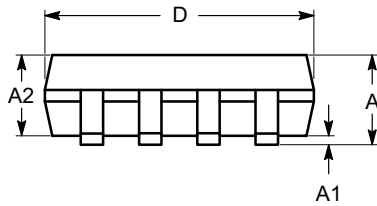

SIDE VIEW

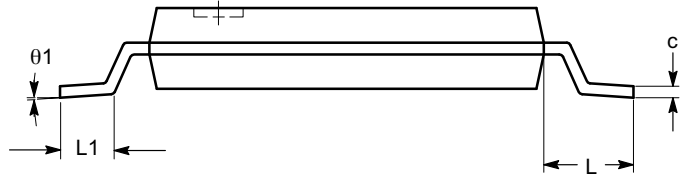

END VIEW

**Notes:**

- (1) All dimensions are in millimeters. Angles in degrees.
- (2) Complies with JEDEC MO-153.

# CAT24C64

## PACKAGE DIMENSIONS

UDFN8, 2x3 EXTENDED PAD  
CASE 517AZ-01  
ISSUE O

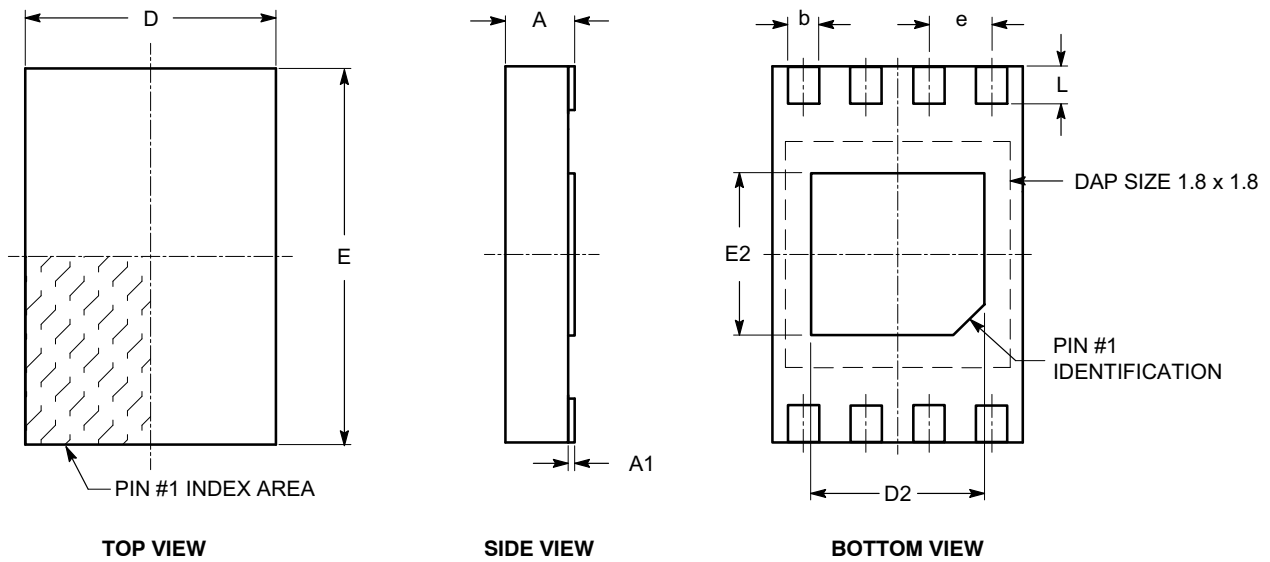

| SYMBOL | MIN       | NOM  | MAX  |
|--------|-----------|------|------|
| A      | 0.45      | 0.50 | 0.55 |
| A1     | 0.00      | 0.02 | 0.05 |
| A3     | 0.127 REF |      |      |
| b      | 0.20      | 0.25 | 0.30 |
| D      | 1.95      | 2.00 | 2.05 |
| D2     | 1.35      | 1.40 | 1.45 |
| E      | 2.95      | 3.00 | 3.05 |
| E2     | 1.25      | 1.30 | 1.35 |
| e      | 0.50 REF  |      |      |
| L      | 0.25      | 0.30 | 0.35 |

**Notes:**

- (1) All dimensions are in millimeters.
- (2) Refer JEDEC MO-236/MO-252.

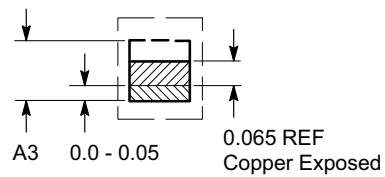
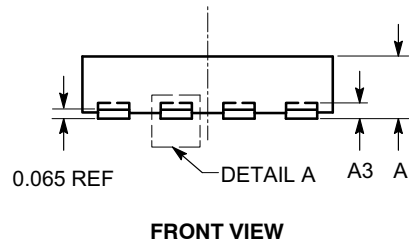

# CAT24C64

## PACKAGE DIMENSIONS

TDFN8, 2x3  
CASE 511AK-01  
ISSUE A



TOP VIEW



SIDE VIEW



BOTTOM VIEW

| SYMBOL | MIN      | NOM  | MAX  |
|--------|----------|------|------|
| A      | 0.70     | 0.75 | 0.80 |
| A1     | 0.00     | 0.02 | 0.05 |
| A2     | 0.45     | 0.55 | 0.65 |
| A3     | 0.20 REF |      |      |
| b      | 0.20     | 0.25 | 0.30 |
| D      | 1.90     | 2.00 | 2.10 |
| D2     | 1.30     | 1.40 | 1.50 |
| E      | 2.90     | 3.00 | 3.10 |
| E2     | 1.20     | 1.30 | 1.40 |
| e      | 0.50 TYP |      |      |
| L      | 0.20     | 0.30 | 0.40 |

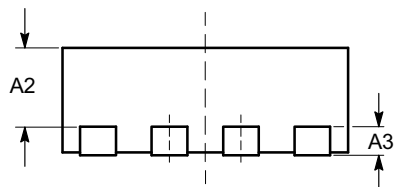

FRONT VIEW

**Notes:**

- (1) All dimensions are in millimeters.
- (2) Complies with JEDEC MO-229.

# CAT24C64

## Example of Ordering Information

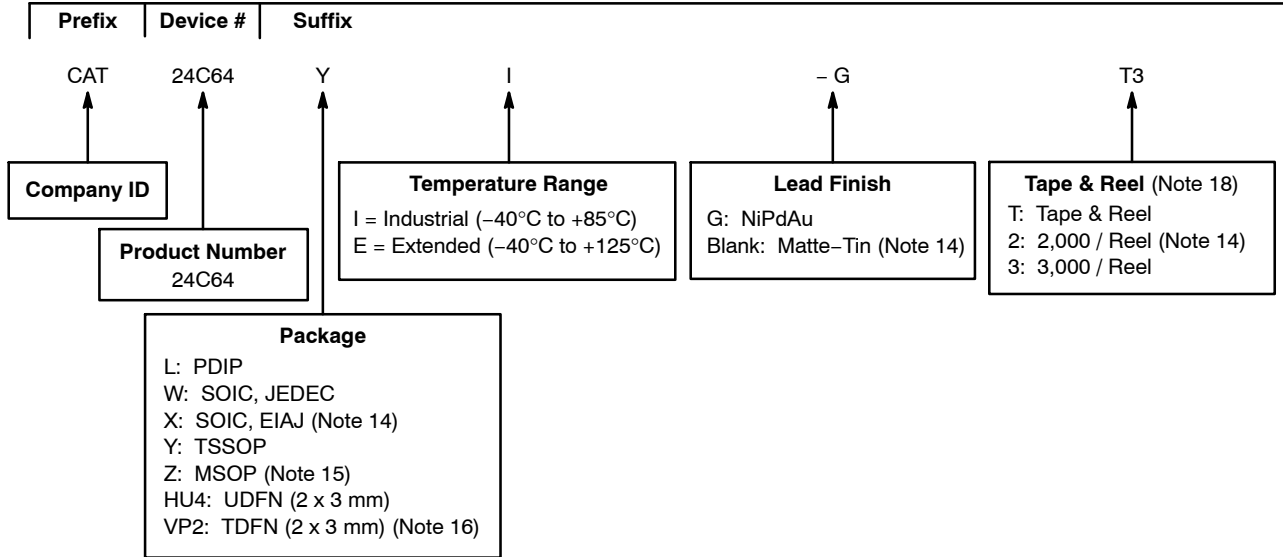

11. All packages are RoHS-compliant (Lead-free, Halogen-free).
12. The standard lead finish is NiPdAu on pre-plated (PPF) lead frames.
13. The device used in the above example is a CAT24C64YI-GT3 (TSSOP, Industrial Temperature, NiPdAu, Tape & Reel, 3,000/Reel).
14. For SOIC, EIAJ (X) package the standard lead finish is Matte-Tin. This package is available in 2,000/Reel, i.e., CAT24C64XI-T2.
15. For availability, please contact your nearest ON Semiconductor Sales office.
16. **The TDFN 2 x 3 x 0.75 mm (VP2) package is not recommended for new designs. Please replace with UDFN 2 x 3 x 0.5 mm (HU4).**
17. For additional package and temperature options, please contact your nearest ON Semiconductor Sales office.
18. For information on tape and reel specifications, including part orientation and tape sizes, please refer to our Tape and Reel Packaging Specifications Brochure, BRD8011/D.

ON Semiconductor is licensed by Philips Corporation to carry the I<sup>2</sup>C Bus Protocol.

ON Semiconductor and  are registered trademarks of Semiconductor Components Industries, LLC (SCILLC). SCILLC reserves the right to make changes without further notice to any products herein. SCILLC makes no warranty, representation or guarantee regarding the suitability of its products for any particular purpose, nor does SCILLC assume any liability arising out of the application or use of any product or circuit, and specifically disclaims any and all liability, including without limitation special, consequential or incidental damages. "Typical" parameters which may be provided in SCILLC data sheets and/or specifications can and do vary in different applications and actual performance may vary over time. All operating parameters, including "Typicals" must be validated for each customer application by customer's technical experts. SCILLC does not convey any license under its patent rights nor the rights of others. SCILLC products are not designed, intended, or authorized for use as components in systems intended for surgical implant into the body, or other applications intended to support or sustain life, or for any other application in which the failure of the SCILLC product could create a situation where personal injury or death may occur. Should Buyer purchase or use SCILLC products for any such unintended or unauthorized application, Buyer shall indemnify and hold SCILLC and its officers, employees, subsidiaries, affiliates, and distributors harmless against all claims, costs, damages, and expenses, and reasonable attorney fees arising out of, directly or indirectly, any claim of personal injury or death associated with such unintended or unauthorized use, even if such claim alleges that SCILLC was negligent regarding the design or manufacture of the part. SCILLC is an Equal Opportunity/Affirmative Action Employer. This literature is subject to all applicable copyright laws and is not for resale in any manner.

## PUBLICATION ORDERING INFORMATION

**LITERATURE FULFILLMENT:**  
Literature Distribution Center for ON Semiconductor  
P.O. Box 5163, Denver, Colorado 80217 USA  
**Phone:** 303-675-2175 or 800-344-3860 Toll Free USA/Canada  
**Fax:** 303-675-2176 or 800-344-3867 Toll Free USA/Canada  
**Email:** orderlit@onsemi.com

**N. American Technical Support:** 800-282-9855 Toll Free  
USA/Canada  
**Europe, Middle East and Africa Technical Support:**  
Phone: 421 33 790 2910  
**Japan Customer Focus Center**  
Phone: 81-3-5773-3850

**ON Semiconductor Website:** [www.onsemi.com](http://www.onsemi.com)  
**Order Literature:** <http://www.onsemi.com/orderlit>  
For additional information, please contact your local Sales Representative

Компания «Океан Электроники» предлагает заключение долгосрочных отношений при поставках импортных электронных компонентов на взаимовыгодных условиях!

Наши преимущества:

- Поставка оригинальных импортных электронных компонентов напрямую с производств Америки, Европы и Азии, а так же с крупнейших складов мира;
- Широкая линейка поставок активных и пассивных импортных электронных компонентов (более 30 млн. наименований);
- Поставка сложных, дефицитных, либо снятых с производства позиций;
- Оперативные сроки поставки под заказ (от 5 рабочих дней);
- Экспресс доставка в любую точку России;
- Помощь Конструкторского Отдела и консультации квалифицированных инженеров;
- Техническая поддержка проекта, помощь в подборе аналогов, поставка прототипов;
- Поставка электронных компонентов под контролем ВП;
- Система менеджмента качества сертифицирована по Международному стандарту ISO 9001;
- При необходимости вся продукция военного и аэрокосмического назначения проходит испытания и сертификацию в лаборатории (по согласованию с заказчиком);
- Поставка специализированных компонентов военного и аэрокосмического уровня качества (Xilinx, Altera, Analog Devices, Intersil, Interpoint, Microsemi, Actel, Aeroflex, Peregrine, VPT, Syfer, Eurofarad, Texas Instruments, MS Kennedy, Miteq, Cobham, E2V, MA-COM, Hittite, Mini-Circuits, General Dynamics и др.);

Компания «Океан Электроники» является официальным дистрибьютором и эксклюзивным представителем в России одного из крупнейших производителей разъемов военного и аэрокосмического назначения «JONHON», а так же официальным дистрибьютором и эксклюзивным представителем в России производителя высокотехнологичных и надежных решений для передачи СВЧ сигналов «FORSTAR».



## JONHON

«JONHON» (основан в 1970 г.)

Разъемы специального, военного и аэрокосмического назначения:

(Применяются в военной, авиационной, аэрокосмической, морской, железнодорожной, горно- и нефтедобывающей отраслях промышленности)

«FORSTAR» (основан в 1998 г.)

ВЧ соединители, коаксиальные кабели, кабельные сборки и микроволновые компоненты:

(Применяются в телекоммуникациях гражданского и специального назначения, в средствах связи, РЛС, а так же военной, авиационной и аэрокосмической отраслях промышленности).



Телефон: 8 (812) 309-75-97 (многоканальный)

Факс: 8 (812) 320-03-32

Электронная почта: [ocean@oceanchips.ru](mailto:ocean@oceanchips.ru)

Web: <http://oceanchips.ru/>

Адрес: 198099, г. Санкт-Петербург, ул. Калинина, д. 2, корп. 4, лит. А