



MICROCHIP TC4423/TC4424/TC4425

3A Dual High-Speed Power MOSFET Drivers

Features

- High Peak Output Current: 3A
- Wide Input Supply Voltage Operating Range:
 - 4.5V to 18V
- High Capacitive Load Drive Capability:
 - 1800 pF in 25 ns
- Short Delay Times: <40 ns (typ)
- Matched Rise/Fall Times
- Low Supply Current:
 - With Logic '1' Input – 3.5 mA (Max)
 - With Logic '0' Input – 350 μ A (Max)
- Low Output Impedance: 3.5 Ω (typ)
- Latch-Up Protected: Will Withstand 1.5A Reverse Current
- Logic Input Will Withstand Negative Swing Up To 5V
- ESD Protected: 4 kV
- Pin compatible with the TC1426/TC1427/TC1428, TC4426/TC4427/TC4428 and TC4426A/TC4427A/TC4428A devices.
- Space-saving 8-Pin 6x5 DFN Package

General Description

The TC4423/TC4424/TC4425 devices are a family of 3A, dual-output buffers/MOSFET drivers. Pin compatible with the TC1426/27/28, TC4426/27/28 and TC4426A/27A/28A dual 1.5A driver families, the TC4423/24/25 family has an increased latch-up current rating of 1.5A, making them even more robust for operation in harsh electrical environments.

As MOSFET drivers, the TC4423/TC4424/TC4425 can easily charge 1800 pF gate capacitance in under 35 nsec, providing low enough impedances in both the on and off states to ensure the MOSFET's intended state will not be affected, even by large transients.

The TC4423/TC4424/TC4425 inputs may be driven directly from either TTL or CMOS (2.4V to 18V). In addition, the 300 mV of built-in hysteresis provides noise immunity and allows the device to be driven from slowly rising or falling waveforms.

Applications

- Switch Mode Power Supplies
- Pulse Transformer Drive
- Line Drivers

Package Types⁽¹⁾



TC4423/TC4424/TC4425

Functional Block Diagram⁽¹⁾



1.0 ELECTRICAL CHARACTERISTICS

Absolute Maximum Ratings †

Supply Voltage	+22V
Input Voltage, IN A or IN B	($V_{DD} + 0.3V$) to (GND – 5V)
Package Power Dissipation ($T_A \leq 70^\circ\text{C}$)	
DFN	Note 2
PDIP	730 mW
SOIC	470 mW

† **Notice:** Stresses above those listed under "Maximum Ratings" may cause permanent damage to the device. This is a stress rating only and functional operation of the device at those or any other conditions above those indicated in the operational sections of this specification is not intended. Exposure to maximum rating conditions for extended periods may affect device reliability.

DC CHARACTERISTICS

Electrical Specifications: Unless otherwise indicated, $T_A = +25^\circ\text{C}$, with $4.5V \leq V_{DD} \leq 18V$.						
Parameters	Sym	Min	Typ	Max	Units	Conditions
Input						
Logic '1', High Input Voltage	V_{IH}	2.4	—	—	V	
Logic '0', Low Input Voltage	V_{IL}	—	—	0.8	V	
Input Current	I_{IN}	-1	—	1	μA	$0V \leq V_{IN} \leq V_{DD}$
Output						
High Output Voltage	V_{OH}	$V_{DD} - 0.025$	—	—	V	
Low Output Voltage	V_{OL}	—	—	0.025	V	
Output Resistance, High	R_{OH}	—	2.8	5	Ω	$I_{OUT} = 10 \text{ mA}$, $V_{DD} = 18V$
Output Resistance, Low	R_{OL}	—	3.5	5	Ω	$I_{OUT} = 10 \text{ mA}$, $V_{DD} = 18V$
Peak Output Current	I_{PK}	—	3	—	A	
Latch-Up Protection Withstand Reverse Current	I_{REV}	—	>1.5	—	A	Duty cycle $\leq 2\%$, $t \leq 300 \mu\text{sec}$.
Switching Time (Note 1)						
Rise Time	t_R	—	23	35	ns	Figure 4-1, Figure 4-2, $C_L = 1800 \text{ pF}$
Fall Time	t_F	—	25	35	ns	Figure 4-1, Figure 4-2, $C_L = 1800 \text{ pF}$
Delay Time	t_{D1}	—	33	75	ns	Figure 4-1, Figure 4-2, $C_L = 1800 \text{ pF}$
Delay Time	t_{D2}	—	38	75	ns	Figure 4-1, Figure 4-2, $C_L = 1800 \text{ pF}$
Power Supply						
Power Supply Current	I_S	—	1.5	2.5	mA	$V_{IN} = 3V$ (Both inputs)
		—	0.15	0.25		$V_{IN} = 0V$ (Both inputs)

Note 1: Switching times ensured by design.

2: Package power dissipation is dependent on the copper pad area on the PCB.

TC4423/TC4424/TC4425

DC CHARACTERISTICS (OVER OPERATING TEMPERATURE RANGE)

Electrical Specifications: Unless otherwise indicated, operating temperature range with $4.5V \leq V_{DD} \leq 18V$.						
Parameters	Sym	Min	Typ	Max	Units	Conditions
Input						
Logic '1', High Input Voltage	V_{IH}	2.4	—	—	V	
Logic '0', Low Input Voltage	V_{IL}	—	—	0.8	V	
Input Current	I_{IN}	-10	—	+10	μA	$0V \leq V_{IN} \leq V_{DD}$
Output						
High Output Voltage	V_{OH}	$V_{DD} - 0.025$	—	—	V	
Low Output Voltage	V_{OL}	—	—	0.025	V	
Output Resistance, High	R_{OH}	—	3.7	8	Ω	$I_{OUT} = 10 \text{ mA}, V_{DD} = 18V$
Output Resistance, Low	R_{OL}	—	4.3	8	Ω	$I_{OUT} = 10 \text{ mA}, V_{DD} = 18V$
Peak Output Current	I_{PK}	—	3.0	—	A	
Latch-Up Protection Withstand Reverse Current	I_{REV}	—	>1.5	—	A	Duty cycle $\leq 2\%$, $t \leq 300 \mu\text{sec}$
Switching Time (Note 1)						
Rise Time	t_R	—	28	60	ns	Figure 4-1, Figure 4-2, $C_L = 1800 \text{ pF}$
Fall Time	t_F	—	32	60	ns	Figure 4-1, Figure 4-2, $C_L = 1800 \text{ pF}$
Delay Time	t_{D1}	—	32	100	ns	Figure 4-1, Figure 4-2, $C_L = 1800 \text{ pF}$
Delay Time	t_{D2}	—	38	100	ns	Figure 4-1, Figure 4-2, $C_L = 1800 \text{ pF}$
Power Supply						
Power Supply Current	I_S	—	2.0	3.5	mA	$V_{IN} = 3V$ (Both inputs) $V_{IN} = 0V$ (Both inputs)

Note 1: Switching times ensured by design.

TEMPERATURE CHARACTERISTICS

Electrical Specifications: Unless otherwise noted, all parameters apply with $4.5V \leq V_{DD} \leq 18V$.						
Parameters	Sym	Min	Typ	Max	Units	Conditions
Temperature Ranges						
Specified Temperature Range (C)	T_A	0	—	+70	$^{\circ}C$	
Specified Temperature Range (E)	T_A	-40	—	+85	$^{\circ}C$	
Specified Temperature Range (V)	T_A	-40	—	+125	$^{\circ}C$	
Maximum Junction Temperature	T_J	—	—	+150	$^{\circ}C$	
Storage Temperature Range	T_A	-65	—	+150	$^{\circ}C$	
Package Thermal Resistances						
Thermal Resistance, 8L-6x5 DFN	θ_{JA}	—	33.2	—	$^{\circ}C/W$	Typical four-layer board with vias to ground plane
Thermal Resistance, 8L-PDIP	θ_{JA}	—	125	—	$^{\circ}C/W$	
Thermal Resistance, 16L-SOIC	θ_{JA}	—	155	—	$^{\circ}C/W$	

2.0 TYPICAL PERFORMANCE CURVES

Note: The graphs and tables provided following this note are a statistical summary based on a limited number of samples and are provided for informational purposes only. The performance characteristics listed herein are not tested or guaranteed. In some graphs or tables, the data presented may be outside the specified operating range (e.g., outside specified power supply range) and therefore outside the warranted range.



FIGURE 2-1: Rise Time vs. Supply Voltage.



FIGURE 2-4: Fall Time vs. Supply Voltage.



FIGURE 2-2: Rise Time vs. Capacitive Load.



FIGURE 2-5: Fall Time vs. Capacitive Load.



FIGURE 2-3: Rise and Fall Times vs. Temperature.



FIGURE 2-6: Propagation Delay vs. Input Amplitude.

TC4423/TC4424/TC4425

Typical Performance Curves (Continued)



FIGURE 2-7: Propagation Delay Time vs. Supply Voltage.



FIGURE 2-10: Propagation Delay Time vs. Temperature.

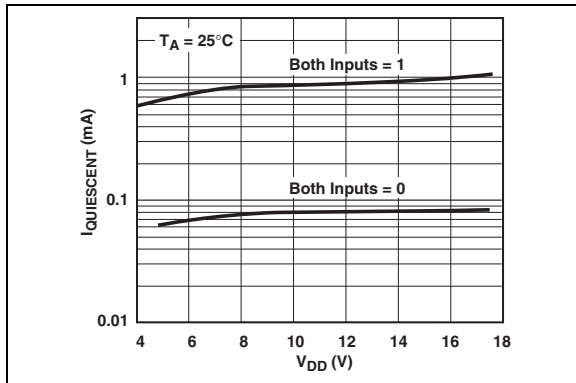

FIGURE 2-8: Quiescent Current vs. Supply Voltage.

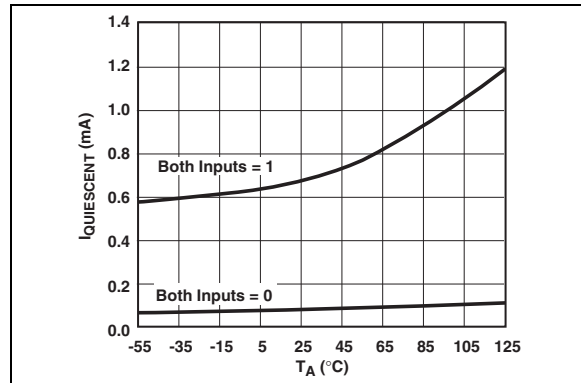

FIGURE 2-11: Quiescent Current vs. Temperature.



FIGURE 2-9: Output Resistance (Output High) vs. Supply Voltage.



FIGURE 2-12: Output Resistance (Output Low) vs. Supply Voltage.

Typical Performance Curves (Continued)

Note: Load on single output only



FIGURE 2-13: Supply Current vs. Capacitive Load.



FIGURE 2-16: Supply Current vs. Frequency.



FIGURE 2-14: Supply Current vs. Capacitive Load.



FIGURE 2-17: Supply Current vs. Frequency.



FIGURE 2-15: Supply Current vs. Capacitive Load.



FIGURE 2-18: Supply Current vs. Frequency.

TC4423/TC4424/TC4425

Typical Performance Curves (Continued)



FIGURE 2-19: *TC4423 Crossover Energy.*

3.0 PIN DESCRIPTIONS

The descriptions of the pins are listed in Table 3-1.

TABLE 3-1: PIN FUNCTION TABLE (1)

8-Pin PDIP	8-Pin DFN	16-Pin SOIC (Wide)	Symbol	Description
1	1	1	NC	No connection
2	2	2	IN A	Input A
—	—	3	NC	No connection
3	3	4	GND	Ground
—	—	5	GND	Ground
—	—	6	NC	No connection
4	4	7	IN B	Input B
—	—	8	NC	No connection
—	—	9	NC	No connection
5	5	10	OUT B	Output B
—	—	11	OUT B	Output B
6	6	12	V _{DD}	Supply input
—	—	13	V _{DD}	Supply input
7	7	14	OUT A	Output A
—	—	15	OUT A	Output A
8	8	16	NC	No connection
—	PAD	—	NC	Exposed Metal Pad

Note 1: Duplicate pins must be connected for proper operation.

3.1 Inputs A and B

Inputs A and B are TTL/CMOS compatible inputs that control outputs A and B, respectively. These inputs have 300 mV of hysteresis between the high and low input levels, allowing them to be driven from slow rising and falling signals, and to provide noise immunity.

3.2 Outputs A and B

Outputs A and B are CMOS push-pull outputs that are capable of sourcing and sinking 3A peaks of current (V_{DD} = 18V). The low output impedance ensures the gate of the external MOSFET will stay in the intended state even during large transients. These outputs also have a reverse current latch-up rating of 1.5A.

3.3 Supply Input (V_{DD})

V_{DD} is the bias supply input for the MOSFET driver and has a voltage range of 4.5V to 18V. This input must be decoupled to ground with a local ceramic capacitor. This bypass capacitor provides a localized low-impedance path for the peak currents that are to be provided to the load.

3.4 Ground (GND)

Ground is the device return pin. The ground pin(s) should have a low-impedance connection to the bias supply source return. High peak currents will flow out the ground pin(s) when the capacitive load is being discharged.

3.5 Exposed Metal Pad

The exposed metal pad of the 6x5 DFN package is not internally connected to any potential. Therefore, this pad can be connected to a ground plane or other copper plane on a printed circuit board to aid in heat removal from the package.

TC4423/TC4424/TC4425

4.0 APPLICATIONS INFORMATION

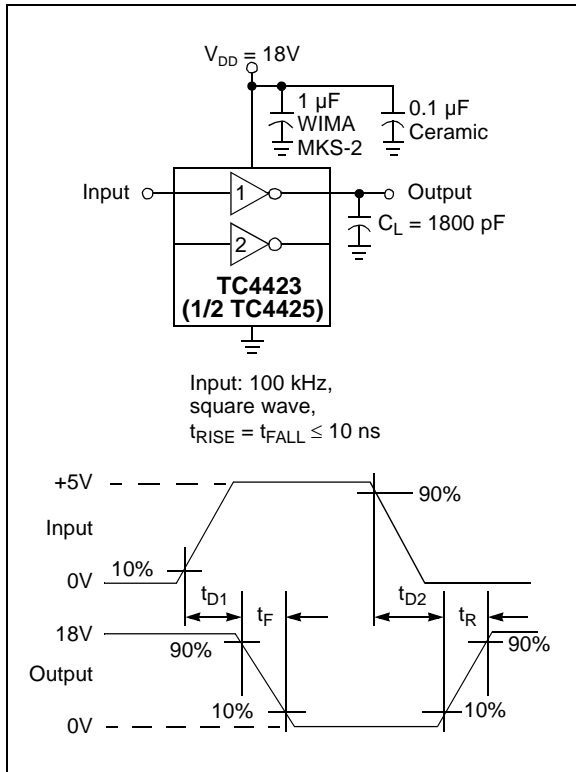

FIGURE 4-1: Inverting Driver Switching Time.

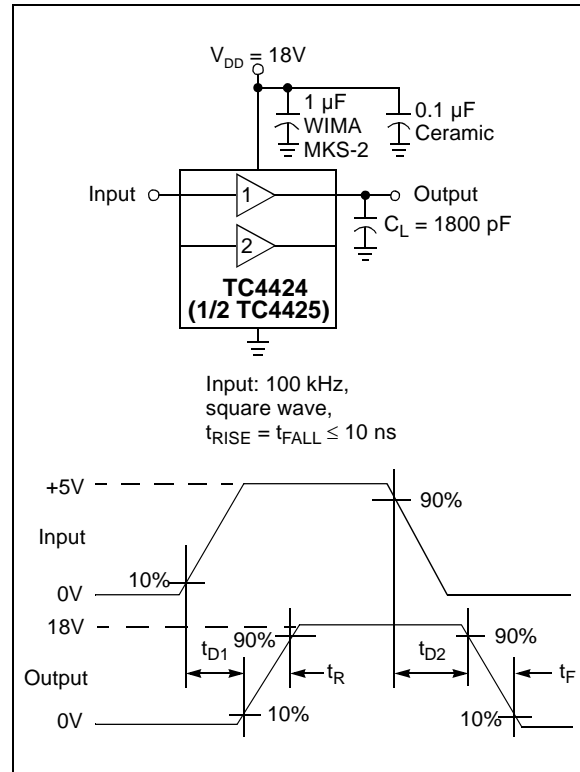
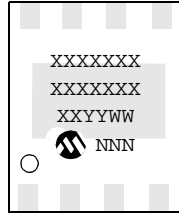

FIGURE 4-2: Non-inverting Driver Switching Time.

5.0 PACKAGING INFORMATION

5.1 Package Marking Information

8-Lead DFN



Example:

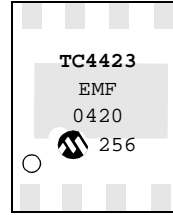

8-Lead PDIP (300 mil)

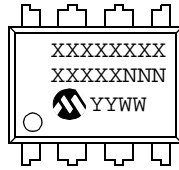

Example:

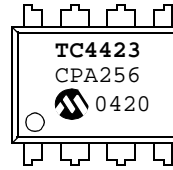

16-Lead SOIC (300 mil)

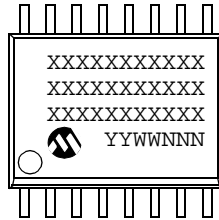

Example:

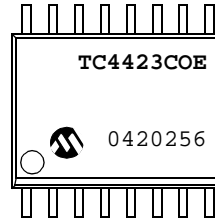

Legend:	XX...X	Customer-specific information
	Y	Year code (last digit of calendar year)
	YY	Year code (last 2 digits of calendar year)
	WW	Week code (week of January 1 is week '01')
	NNN	Alphanumeric traceability code
	(e3)	Pb-free JEDEC designator for Matte Tin (Sn)
	*	This package is Pb-free. The Pb-free JEDEC designator (e3) can be found on the outer packaging for this package.

Note: In the event the full Microchip part number cannot be marked on one line, it will be carried over to the next line, thus limiting the number of available characters for customer-specific information.

TC4423/TC4424/TC4425

8-Lead Plastic Dual Flat No Lead Package (MF) 6x5 mm Body (DFN-S) – Saw Singulated

Note: For the most current package drawings, please see the Microchip Packaging Specification located at <http://www.microchip.com/packaging>



TOP VIEW

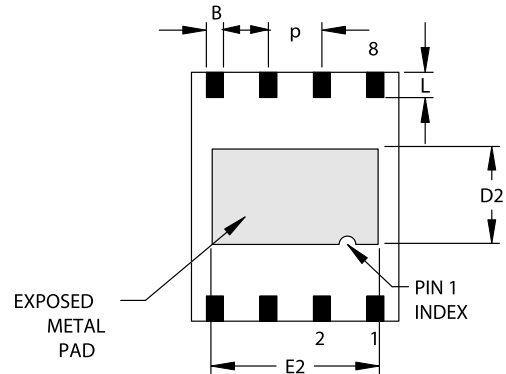

BOTTOM VIEW



Dimension Limits	Units	INCHES			MILLIMETERS*		
		MIN	NOM	MAX	MIN	NOM	MAX
Number of Pins	n		8			8	
Pitch	p	.050 BSC			1.27 BSC		
Overall Height	A	.033	.035	.037	0.85	0.90	0.95
Package Thickness	A2	.031	.035	.037	0.80	0.89	0.95
Standoff	A1	.000	.0004	.002	0.00	0.01	0.05
Base Thickness	A3	.007	.008	.009	0.17	0.20	0.23
Overall Length	E	.195	.197	.199	4.95	5.00	5.05
Exposed Pad Length	E2	.152	.157	.163	3.85	4.00	4.15
Overall Width	D	.234	.236	.238	5.95	6.00	6.05
Exposed Pad Width	D2	.089	.091	.093	2.25	2.30	2.35
Lead Width	B	.014	.016	.019	0.35	0.40	0.47
Lead Length	L	.024		.026	0.60		0.65

Notes:

JEDEC equivalent: MO-220

Drawing No. C04-122

Revised 11/3/03

TC4423/TC4424/TC4425

8-Lead Plastic Dual In-line (P) – 300 mil (PDIP)

Note: For the most current package drawings, please see the Microchip Packaging Specification located at <http://www.microchip.com/packaging>

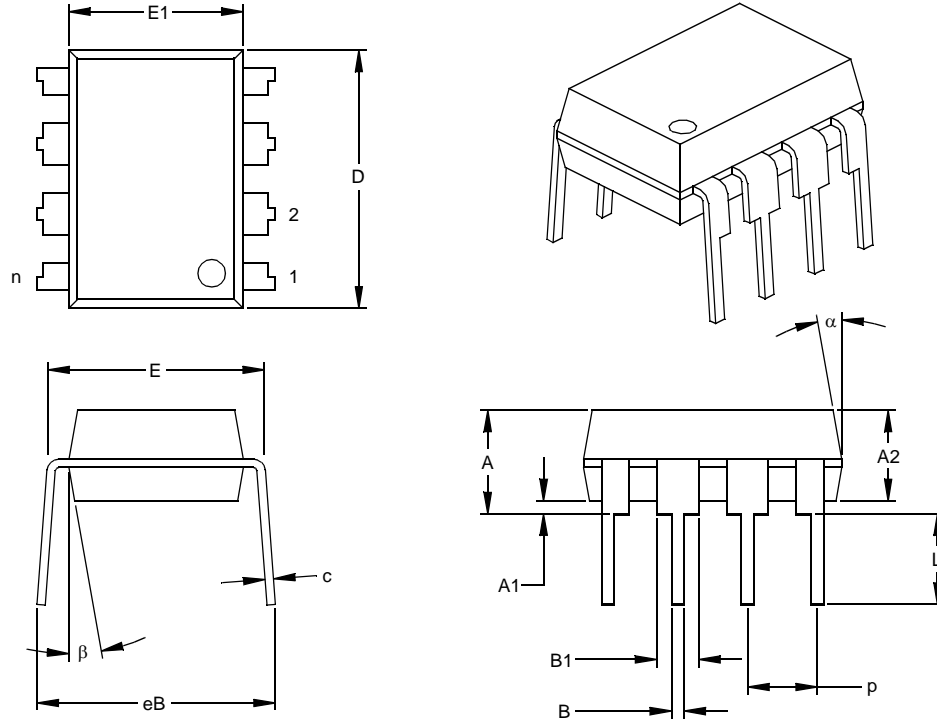

Dimension Limits	Units	INCHES*			MILLIMETERS		
		MIN	NOM	MAX	MIN	NOM	MAX
Number of Pins	n		8			8	
Pitch	p		.100			2.54	
Top to Seating Plane	A	.140	.155	.170	3.56	3.94	4.32
Molded Package Thickness	A2	.115	.130	.145	2.92	3.30	3.68
Base to Seating Plane	A1	.015			0.38		
Shoulder to Shoulder Width	E	.300	.313	.325	7.62	7.94	8.26
Molded Package Width	E1	.240	.250	.260	6.10	6.35	6.60
Overall Length	D	.360	.373	.385	9.14	9.46	9.78
Tip to Seating Plane	L	.125	.130	.135	3.18	3.30	3.43
Lead Thickness	c	.008	.012	.015	0.20	0.29	0.38
Upper Lead Width	B1	.045	.058	.070	1.14	1.46	1.78
Lower Lead Width	B	.014	.018	.022	0.36	0.46	0.56
Overall Row Spacing	§ eB	.310	.370	.430	7.87	9.40	10.92
Mold Draft Angle Top	α	5	10	15	5	10	15
Mold Draft Angle Bottom	β	5	10	15	5	10	15

* Controlling Parameter

§ Significant Characteristic

Notes:

Dimensions D and E1 do not include mold flash or protrusions. Mold flash or protrusions shall not exceed .010" (0.254mm) per side.

JEDEC Equivalent: MS-001

Drawing No. C04-018

TC4423/TC4424/TC4425

16-Lead Plastic Small Outline (SO) – Wide, 300 mil (SOIC)

Note: For the most current package drawings, please see the Microchip Packaging Specification located at <http://www.microchip.com/packaging>



Dimension Limits	Units	INCHES*			MILLIMETERS		
		MIN	NOM	MAX	MIN	NOM	MAX
Number of Pins	n		16			16	
Pitch	p		.050			1.27	
Overall Height	A	.093	.099	.104	2.36	2.50	2.64
Molded Package Thickness	A2	.088	.091	.094	2.24	2.31	2.39
Standoff §	A1	.004	.008	.012	0.10	0.20	0.30
Overall Width	E	.394	.407	.420	10.01	10.34	10.67
Molded Package Width	E1	.291	.295	.299	7.39	7.49	7.59
Overall Length	D	.398	.406	.413	10.10	10.30	10.49
Chamfer Distance	h	.010	.020	.029	0.25	0.50	0.74
Foot Length	L	.016	.033	.050	0.41	0.84	1.27
Foot Angle	φ	0	4	8	0	4	8
Lead Thickness	c	.009	.011	.013	0.23	0.28	0.33
Lead Width	B	.014	.017	.020	0.36	0.42	0.51
Mold Draft Angle Top	α	0	12	15	0	12	15
Mold Draft Angle Bottom	β	0	12	15	0	12	15

* Controlling Parameter
 § Significant Characteristic

Notes:

Dimensions D and E1 do not include mold flash or protrusions. Mold flash or protrusions shall not exceed .010" (0.254mm) per side.
 JEDEC Equivalent: MS-013
 Drawing No. C04-102

6.0 REVISION HISTORY

Revision E (December 2012)

Added a note to each package outline drawing.

TC4423/TC4424/TC4425

TC4423/TC4424/TC4425

PRODUCT IDENTIFICATION SYSTEM

To order or obtain information, e.g., on pricing or delivery, refer to the factory or the listed sales office.

<u>PART NO.</u>	<u>X</u>	<u>XX</u>	<u>XXX</u>	<u>X</u>	
Device	Temperature Range	Package	Tape & Reel	PB Free	
Device:	TC4423:	3A Dual MOSFET Driver, Inverting			
	TC4424:	3A Dual MOSFET Driver, Non-Inverting			
	TC4425:	3A Dual MOSFET Driver, Complementary			
Temperature Range:	C =	0°C to +70°C (PDIP & SOIC Only)			
	E =	-40°C to +85°C			
	V =	-40°C to +125°C			
Package:	MF =	Dual, Flat, No-Lead (6x5 mm Body), 8-lead			
	MF713 =	Dual, Flat, No-Lead (6x5 mm Body), 8-lead (Tape and Reel)			
	OE =	SOIC (Wide), 16-pin			
	OE713 =	SOIC (Wide), 16-pin (Tape and Reel)			
	PA =	Plastic DIP, (300 mil body), 8-lead			
PB Free:	G =	Lead-Free device *			
		= Blank			
* Available on selected packages. Contact your local sales representative for availability.					
Examples:					
a)	TC4423COE:	3A Dual Inverting MOSFET Driver, 0°C to +70°C, 16LD SOIC package.			
b)	TC4423CPA:	3A Dual Inverting MOSFET Driver, 0°C to +70°C, 8LD PDIP package.			
c)	TC4423VMF:	3A Dual Inverting MOSFET Driver, -40°C to +125°C, 8LD DFN package.			
a)	TC4424COE713:	3A Dual Non-Inverting, MOSFET Driver, 0°C to +70°C, 16LD SOIC package, Tape and Reel.			
b)	TC4424EPA:	3A Dual Non-Inverting, MOSFET Driver, -40°C to +85°C, 8LD PDIP package.			
a)	TC4425EOE:	3A Dual Complementary, MOSFET Driver, -40°C to +85°C, 16LD SOIC package.			
b)	TC4425CPA:	3A Dual Complementary, MOSFET Driver, 0°C to +70°C, PDIP package.			

Sales and Support

Data Sheets

Products supported by a preliminary Data Sheet may have an errata sheet describing minor operational differences and recommended workarounds. To determine if an errata sheet exists for a particular device, please contact one of the following:

1. Your local Microchip sales office
2. The Microchip Worldwide Site (www.microchip.com)

Please specify which device, revision of silicon and Data Sheet (include Literature #) you are using.

Customer Notification System

Register on our web site (www.microchip.com/cn) to receive the most current information on our products.

TC4423/TC4424/TC4425

NOTES:

Note the following details of the code protection feature on Microchip devices:

- Microchip products meet the specification contained in their particular Microchip Data Sheet.
- Microchip believes that its family of products is one of the most secure families of its kind on the market today, when used in the intended manner and under normal conditions.
- There are dishonest and possibly illegal methods used to breach the code protection feature. All of these methods, to our knowledge, require using the Microchip products in a manner outside the operating specifications contained in Microchip's Data Sheets. Most likely, the person doing so is engaged in theft of intellectual property.
- Microchip is willing to work with the customer who is concerned about the integrity of their code.
- Neither Microchip nor any other semiconductor manufacturer can guarantee the security of their code. Code protection does not mean that we are guaranteeing the product as “unbreakable.”

Code protection is constantly evolving. We at Microchip are committed to continuously improving the code protection features of our products. Attempts to break Microchip's code protection feature may be a violation of the Digital Millennium Copyright Act. If such acts allow unauthorized access to your software or other copyrighted work, you may have a right to sue for relief under that Act.

Information contained in this publication regarding device applications and the like is provided only for your convenience and may be superseded by updates. It is your responsibility to ensure that your application meets with your specifications. MICROCHIP MAKES NO REPRESENTATIONS OR WARRANTIES OF ANY KIND WHETHER EXPRESS OR IMPLIED, WRITTEN OR ORAL, STATUTORY OR OTHERWISE, RELATED TO THE INFORMATION, INCLUDING BUT NOT LIMITED TO ITS CONDITION, QUALITY, PERFORMANCE, MERCHANTABILITY OR FITNESS FOR PURPOSE. Microchip disclaims all liability arising from this information and its use. Use of Microchip devices in life support and/or safety applications is entirely at the buyer's risk, and the buyer agrees to defend, indemnify and hold harmless Microchip from any and all damages, claims, suits, or expenses resulting from such use. No licenses are conveyed, implicitly or otherwise, under any Microchip intellectual property rights.

Trademarks

The Microchip name and logo, the Microchip logo, dsPIC, FlashFlex, KEELOQ, KEELOQ logo, MPLAB, PIC, PICmicro, PICSTART, PIC³² logo, rPIC, SST, SST Logo, SuperFlash and UNI/O are registered trademarks of Microchip Technology Incorporated in the U.S.A. and other countries.

FilterLab, Hampshire, HI-TECH C, Linear Active Thermistor, MTP, SEEVAL and The Embedded Control Solutions Company are registered trademarks of Microchip Technology Incorporated in the U.S.A.

Silicon Storage Technology is a registered trademark of Microchip Technology Inc. in other countries.

Analog-for-the-Digital Age, Application Maestro, BodyCom, chipKIT, chipKIT logo, CodeGuard, dsPICDEM, dsPICDEM.net, dsPICworks, dsSPEAK, ECAN, ECONOMONITOR, FanSense, HI-TIDE, In-Circuit Serial Programming, ICSP, Mindi, MiWi, MPASM, MPF, MPLAB Certified logo, MPLIB, MPLINK, mTouch, Omniclient Code Generation, PICC, PICC-18, PICDEM, PICDEM.net, PICkit, PICtail, REAL ICE, rLAB, Select Mode, SQI, Serial Quad I/O, Total Endurance, TSHARC, UniWinDriver, WiperLock, ZENA and Z-Scale are trademarks of Microchip Technology Incorporated in the U.S.A. and other countries.

SQTP is a service mark of Microchip Technology Incorporated in the U.S.A.

GestIC and ULPP are registered trademarks of Microchip Technology Germany II GmbH & Co. & KG, a subsidiary of Microchip Technology Inc., in other countries.

All other trademarks mentioned herein are property of their respective companies.

© 2002-2012, Microchip Technology Incorporated, Printed in the U.S.A., All Rights Reserved.

 Printed on recycled paper.

ISBN: 9781620767962

QUALITY MANAGEMENT SYSTEM
CERTIFIED BY DNV
== ISO/TS 16949 ==

Microchip received ISO/TS-16949:2009 certification for its worldwide headquarters, design and wafer fabrication facilities in Chandler and Tempe, Arizona; Gresham, Oregon and design centers in California and India. The Company's quality system processes and procedures are for its PIC[®] MCUs and dsPIC[®] DSCs, KEELOQ[®] code hopping devices, Serial EEPROMs, microperipherals, nonvolatile memory and analog products. In addition, Microchip's quality system for the design and manufacture of development systems is ISO 9001:2000 certified.



MICROCHIP

Worldwide Sales and Service

AMERICAS

Corporate Office
2355 West Chandler Blvd.
Chandler, AZ 85224-6199
Tel: 480-792-7200
Fax: 480-792-7277
Technical Support:
<http://www.microchip.com/support>
Web Address:
www.microchip.com

Atlanta
Duluth, GA
Tel: 678-957-9614
Fax: 678-957-1455

Boston
Westborough, MA
Tel: 774-760-0087
Fax: 774-760-0088

Chicago
Itasca, IL
Tel: 630-285-0071
Fax: 630-285-0075

Cleveland
Independence, OH
Tel: 216-447-0464
Fax: 216-447-0643

Dallas
Addison, TX
Tel: 972-818-7423
Fax: 972-818-2924

Detroit
Farmington Hills, MI
Tel: 248-538-2250
Fax: 248-538-2260

Indianapolis
Noblesville, IN
Tel: 317-773-8323
Fax: 317-773-5453

Los Angeles
Mission Viejo, CA
Tel: 949-462-9523
Fax: 949-462-9608

Santa Clara
Santa Clara, CA
Tel: 408-961-6444
Fax: 408-961-6445

Toronto
Mississauga, Ontario,
Canada
Tel: 905-673-0699
Fax: 905-673-6509

ASIA/PACIFIC

Asia Pacific Office
Suites 3707-14, 37th Floor
Tower 6, The Gateway
Harbour City, Kowloon
Hong Kong
Tel: 852-2401-1200
Fax: 852-2401-3431

Australia - Sydney
Tel: 61-2-9868-6733
Fax: 61-2-9868-6755

China - Beijing
Tel: 86-10-8569-7000
Fax: 86-10-8528-2104

China - Chengdu
Tel: 86-28-8665-5511
Fax: 86-28-8665-7889

China - Chongqing
Tel: 86-23-8980-9588
Fax: 86-23-8980-9500

China - Hangzhou
Tel: 86-571-2819-3187
Fax: 86-571-2819-3189

China - Hong Kong SAR
Tel: 852-2943-5100
Fax: 852-2401-3431

China - Nanjing
Tel: 86-25-8473-2460
Fax: 86-25-8473-2470

China - Qingdao
Tel: 86-532-8502-7355
Fax: 86-532-8502-7205

China - Shanghai
Tel: 86-21-5407-5533
Fax: 86-21-5407-5066

China - Shenyang
Tel: 86-24-2334-2829
Fax: 86-24-2334-2393

China - Shenzhen
Tel: 86-755-8864-2200
Fax: 86-755-8203-1760

China - Wuhan
Tel: 86-27-5980-5300
Fax: 86-27-5980-5118

China - Xian
Tel: 86-29-8833-7252
Fax: 86-29-8833-7256

China - Xiamen
Tel: 86-592-2388138
Fax: 86-592-2388130

China - Zhuhai
Tel: 86-756-3210040
Fax: 86-756-3210049

ASIA/PACIFIC

India - Bangalore
Tel: 91-80-3090-4444
Fax: 91-80-3090-4123

India - New Delhi
Tel: 91-11-4160-8631
Fax: 91-11-4160-8632

India - Pune
Tel: 91-20-2566-1512
Fax: 91-20-2566-1513

Japan - Osaka
Tel: 81-66-152-7160
Fax: 81-66-152-9310

Japan - Yokohama
Tel: 81-45-471-6166
Fax: 81-45-471-6122

Korea - Daegu
Tel: 82-53-744-4301
Fax: 82-53-744-4302

Korea - Seoul
Tel: 82-2-554-7200
Fax: 82-2-558-5932 or
82-2-558-5934

Malaysia - Kuala Lumpur
Tel: 60-3-6201-9857
Fax: 60-3-6201-9859

Malaysia - Penang
Tel: 60-4-227-8870
Fax: 60-4-227-4068

Philippines - Manila
Tel: 63-2-634-9065
Fax: 63-2-634-9069

Singapore
Tel: 65-6334-8870
Fax: 65-6334-8850

Taiwan - Hsin Chu
Tel: 886-3-5778-366
Fax: 886-3-5770-955

Taiwan - Kaohsiung
Tel: 886-7-213-7828
Fax: 886-7-330-9305

Taiwan - Taipei
Tel: 886-2-2508-8600
Fax: 886-2-2508-0102

Thailand - Bangkok
Tel: 66-2-694-1351
Fax: 66-2-694-1350

EUROPE

Austria - Wels
Tel: 43-7242-2244-39
Fax: 43-7242-2244-393

Denmark - Copenhagen
Tel: 45-4450-2828
Fax: 45-4485-2829

France - Paris
Tel: 33-1-69-53-63-20
Fax: 33-1-69-30-90-79

Germany - Munich
Tel: 49-89-627-144-0
Fax: 49-89-627-144-44

Italy - Milan
Tel: 39-0331-742611
Fax: 39-0331-466781

Netherlands - Drunen
Tel: 31-416-690399
Fax: 31-416-690340

Spain - Madrid
Tel: 34-91-708-08-90
Fax: 34-91-708-08-91

UK - Wokingham
Tel: 44-118-921-5869
Fax: 44-118-921-5820

11/27/12

Компания «Океан Электроники» предлагает заключение долгосрочных отношений при поставках импортных электронных компонентов на взаимовыгодных условиях!

Наши преимущества:

- Поставка оригинальных импортных электронных компонентов напрямую с производств Америки, Европы и Азии, а так же с крупнейших складов мира;
- Широкая линейка поставок активных и пассивных импортных электронных компонентов (более 30 млн. наименований);
- Поставка сложных, дефицитных, либо снятых с производства позиций;
- Оперативные сроки поставки под заказ (от 5 рабочих дней);
- Экспресс доставка в любую точку России;
- Помощь Конструкторского Отдела и консультации квалифицированных инженеров;
- Техническая поддержка проекта, помощь в подборе аналогов, поставка прототипов;
- Поставка электронных компонентов под контролем ВП;
- Система менеджмента качества сертифицирована по Международному стандарту ISO 9001;
- При необходимости вся продукция военного и аэрокосмического назначения проходит испытания и сертификацию в лаборатории (по согласованию с заказчиком);
- Поставка специализированных компонентов военного и аэрокосмического уровня качества (Xilinx, Altera, Analog Devices, Intersil, Interpoint, Microsemi, Actel, Aeroflex, Peregrine, VPT, Syfer, Eurofarad, Texas Instruments, MS Kennedy, Miteq, Cobham, E2V, MA-COM, Hittite, Mini-Circuits, General Dynamics и др.);

Компания «Океан Электроники» является официальным дистрибьютором и эксклюзивным представителем в России одного из крупнейших производителей разъемов военного и аэрокосмического назначения «JONHON», а так же официальным дистрибьютором и эксклюзивным представителем в России производителя высокотехнологичных и надежных решений для передачи СВЧ сигналов «FORSTAR».



JONHON

«JONHON» (основан в 1970 г.)

Разъемы специального, военного и аэрокосмического назначения:

(Применяются в военной, авиационной, аэрокосмической, морской, железнодорожной, горно- и нефтедобывающей отраслях промышленности)

«FORSTAR» (основан в 1998 г.)

ВЧ соединители, коаксиальные кабели, кабельные сборки и микроволновые компоненты:

(Применяются в телекоммуникациях гражданского и специального назначения, в средствах связи, РЛС, а так же военной, авиационной и аэрокосмической отраслях промышленности).



Телефон: 8 (812) 309-75-97 (многоканальный)

Факс: 8 (812) 320-03-32

Электронная почта: ocean@oceanchips.ru

Web: <http://oceanchips.ru/>

Адрес: 198099, г. Санкт-Петербург, ул. Калинина, д. 2, корп. 4, лит. А