

11mm Snap-In, Insulated and Metal Shaft

Application

- ✓ TV/Video, Audio, Home appliance, Musical instrument

Feature

- ✓ Closed structure helps reducing dust



■ Specification

Total Rotational Angle	300±5°
Maximum Operating Voltage	50V AC, 20V DC (RV110TF series is designed for AC voltage only)
Insulation Resistance	100MΩ at DC500V
Dielectric Strength	AC300V for 1 minute
Rotational Torque	20-200 gf.cm (RV110F-40B1: 10-200 gf.cm)
Click Torque	Rotational torque + 20-200 gf.cm (RV110F-40B1: Rotational torque + 10-200 gf.cm)
Rotational Stop Strength of the Shaft	With bushing: 5 kgf.cm min; without bushing: 4kgf.cm min
Push/Pull Strength of the Shaft	6kgf for 3 sec
Rotation Life	15,000 cycles

■ How to order

RV110F-20 – 15A - B10K - 0C

[Model](#)

[Shaft Type](#)

Taper and Resistance Value

Order Code	Taper	Resistance Value
A100K	Log/A	100KΩ
B1M	Linear/B	1MΩ
C500K	Rev-log/C	500KΩ

Taper: A, B and C

Resistance Value: 1KΩ to 500KΩ and 1MΩ

*Contact us for other requirements.

** RV112F series only has W taper

Click

Order Code	Description
Blank	No click
0C	With center click

11mm Snap-In, Insulated and Metal Shaft

Model Description



Model	Number of Unit	Terminal Type	With Sleeve or Bushing	Tap
RV110F-20	Single unit	Horizontal	N/A	N/A
RV110F-21	Single unit	Horizontal	N/A	N/A
RV110F-20E1	Single unit	Horizontal	Bushing	N/A
RV110F-21E1	Single unit	Horizontal	Bushing	N/A
RV110F-40	Single unit	Vertical	N/A	N/A
RV110CF-40	Single unit	Vertical	Sleeve	N/A
RV110F-40B1	Single unit	Vertical	Bushing	N/A
RV110F-40E1	Single unit	Vertical	Bushing	N/A
RV110TF-20	Single unit	Horizontal	N/A	With tap
RV110TF-20E1	Single unit	Horizontal	Bushing	With tap
RV110TF-40	Single unit	Vertical	N/A	With tap
RV110TCF-40	Single unit	Vertical	Sleeve	With tap
RV110TF-40B1	Single unit	Vertical	Bushing	With tap
RV110TF-40E1	Single unit	Vertical	Bushing	With tap
RV112F-40	Dual unit	Vertical	N/A	N/A

[Back to top](#)

11mm Snap-In, Insulated and Metal Shaft

Order Code	Outline Drawing											
RV110F-20 RV110F-21 		SHAFT SHOWN IN FULL C.C.W POSITION 	<table border="1" data-bbox="1292 324 1428 414"> <thead> <tr> <th>Type</th> <th>H</th> <th>N</th> </tr> </thead> <tbody> <tr> <td>20</td> <td>10.0</td> <td>3.2</td> </tr> <tr> <td>21</td> <td>12.5</td> <td>4.5</td> </tr> </tbody> </table>  <p>P.C.B. MOUNTING HOLE DETAIL</p>	Type	H	N	20	10.0	3.2	21	12.5	4.5
Type	H	N										
20	10.0	3.2										
21	12.5	4.5										
RV110F-20E1 RV110F-21E1 		SHAFT SHOWN IN FULL C.C.W POSITION 	<table border="1" data-bbox="1292 772 1428 862"> <thead> <tr> <th>Type</th> <th>H</th> <th>N</th> </tr> </thead> <tbody> <tr> <td>20</td> <td>10.0</td> <td>3.2</td> </tr> <tr> <td>21</td> <td>12.5</td> <td>4.5</td> </tr> </tbody> </table>  <p>P.C.B. MOUNTING HOLE DETAIL</p>	Type	H	N	20	10.0	3.2	21	12.5	4.5
Type	H	N										
20	10.0	3.2										
21	12.5	4.5										
RV110F-40 		SHAFT SHOWN IN FULL C.C.W POSITION 	 <p>P.C.B. MOUNTING HOLE DETAIL</p>									
RV110CF-40 		SHAFT SHOWN IN FULL C.C.W POSITION 	 <p>P.C.B. MOUNTING HOLE DETAIL</p>									

[Back to top](#)

11mm Snap-In, Insulated and Metal Shaft

Order Code	Outline Drawing											
RV110F-40B1 		<p>SHAFT SHOWN IN FULL C.C.W POSITION</p> 	 <p>P.C.B. MOUNTING HOLE DETAIL</p>									
RV110F-40E1 		<p>SHAFT SHOWN IN FULL C.C.W POSITION</p> 	 <p>P.C.B. MOUNTING HOLE DETAIL</p>									
RV110TF-20 RV110TF-21 		<p>SHAFT SHOWN IN FULL C.C.W POSITION</p> 	<table border="1" data-bbox="1316 1198 1444 1288"> <thead> <tr> <th>Type</th> <th>H</th> <th>N</th> </tr> </thead> <tbody> <tr> <td>20</td> <td>10.0</td> <td>3.2</td> </tr> <tr> <td>21</td> <td>12.5</td> <td>4.5</td> </tr> </tbody> </table>  <p>P.C.B. MOUNTING HOLE DETAIL</p>	Type	H	N	20	10.0	3.2	21	12.5	4.5
Type	H	N										
20	10.0	3.2										
21	12.5	4.5										
RV110TF-20E1 RV110TF-21E1 		<p>SHAFT SHOWN IN FULL C.C.W POSITION</p> 	<table border="1" data-bbox="1316 1646 1444 1736"> <thead> <tr> <th>Type</th> <th>H</th> <th>N</th> </tr> </thead> <tbody> <tr> <td>20</td> <td>10.0</td> <td>3.2</td> </tr> <tr> <td>21</td> <td>12.5</td> <td>4.5</td> </tr> </tbody> </table>  <p>P.C.B. MOUNTING HOLE DETAIL</p>	Type	H	N	20	10.0	3.2	21	12.5	4.5
Type	H	N										
20	10.0	3.2										
21	12.5	4.5										

[Back to top](#)

11mm Snap-In, Insulated and Metal Shaft

Order Code	Outline Drawing		
<p>RV110TF-40</p> 		<p>SHAFT SHOWN IN FULL C.C.W POSITION</p> 	 <p>P.C.B. MOUNTING HOLE DETAIL</p>
<p>RV110TCF-40</p> 		<p>SHAFT SHOWN IN FULL C.C.W POSITION</p> 	 <p>P.C.B. MOUNTING HOLE DETAIL</p>
<p>RV110TF-40B1</p> 		<p>SHAFT SHOWN IN FULL C.C.W POSITION</p> 	 <p>P.C.B. MOUNTING HOLE DETAIL</p>
<p>RV110TF-40E1</p> 		<p>SHAFT SHOWN IN FULL C.C.W POSITION</p> 	 <p>P.C.B. MOUNTING HOLE DETAIL</p>

[Back to top](#)

11mm Snap-In, Insulated and Metal Shaft

Order Code	Outline Drawing
RV112F-40 	 <p>SHAFT SHOWN IN FULL C.C.W POSITION</p> <p>P.C.B. MOUNTING HOLE DETAIL</p>

■ Metal Shaft Type

F Type	K Type																
RV110F-40B1-(L)F RV110TF-40B1-(L)F	RV110F-40B1-(L)K RV110TF-40B1-(L)K																
																	
<table border="1" data-bbox="172 1599 692 1697"> <thead> <tr> <th>Order Code</th> <th>15F</th> <th>20F</th> <th>25F</th> </tr> </thead> <tbody> <tr> <td>L</td> <td>15</td> <td>20</td> <td>25</td> </tr> </tbody> </table>	Order Code	15F	20F	25F	L	15	20	25	<table border="1" data-bbox="900 1599 1420 1697"> <thead> <tr> <th>Order Code</th> <th>15K</th> <th>20K</th> <th>25K</th> </tr> </thead> <tbody> <tr> <td>L</td> <td>15</td> <td>20</td> <td>25</td> </tr> </tbody> </table>	Order Code	15K	20K	25K	L	15	20	25
Order Code	15F	20F	25F														
L	15	20	25														
Order Code	15K	20K	25K														
L	15	20	25														

[Back to top](#)

11mm Snap-In, Insulated and Metal Shaft

■ A / AW Plastic Shaft Type

RV110F-20 (21)-(L)A RV110TF-20 (21)-(L)A	RV110F-40-(L)A RV110TF-40-(L)A RV112F-40-(L)A	RV110CF-40-(L)A RV110TCF-40-(L)A
		

Order Code	*15A	20A	225A	25A	275A	30A	325A	35A	375A
L	15	20	21	25	27.5	30	32.5	35	37.5
F	4.5	7	7	7	12	12	12	12	12

**15 mm is not available for RV110CF-40 and RV110CTF-40 models.

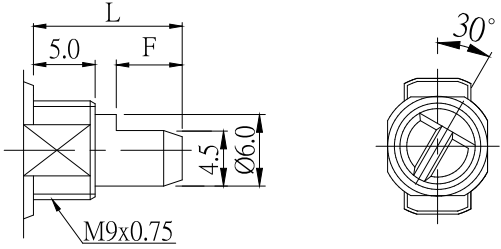
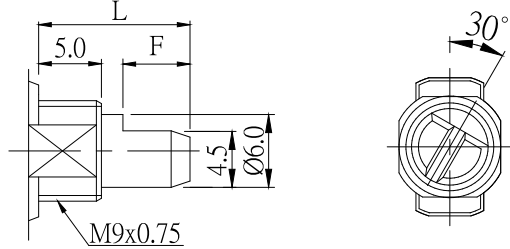
RV110(T)F-20E1(21E1)-(L)A	RV110(T)F-40E1-(L)A
	

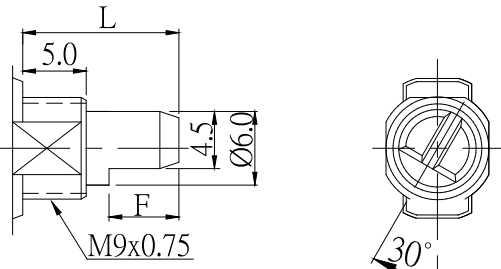
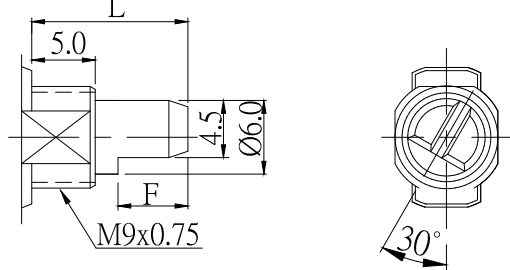
RV110(T)F-20E1(21E1)-(L)AW	RV110(T)F-40E1-(L)AW
	

Order Code	125A	135A	15A	175A	20A	225A	25A	275A	29A	30A
	125AW	135AW	15AW	175AW	20AW	225AW	25AW	275AW	29AW	30AW
L	12.5	13.5	15	17.5	20	22.5	25	27.5	29	30
F	7	7	7	7*	12	12	12	12	12	12

**17.5mm with F = 7mm is only available for A type, not AW type.

[Back to top](#)

11mm Snap-In, Insulated and Metal Shaft

■ B Plastic Shaft Type

RV110F-20 (21)-(L)B RV110TF-20 (21)-(L)B	RV110F-40-(L)B RV110TF-40-(L)B RV112F-40-(L)B	RV110CF-40-(L)B RV110TCF-40-(L)B
		

Order Code	*15B	20B	225B	25B	275B	30B	375B
L	15	20	21	25	27.5	30	37.5
T	6	7	7	12	12	12	12

**15 mm shaft is not available for RV110CF-40 and RV110CTF-40 models.

RV110F-20E1(21E1)-(L)B RV110TF-20E1(21E1)-(L)B	RV110F-40E1-(L)B RV110TF-40E1-(L)B
	

Order Code	125B	15B	175B	20B	225B	25B
L	12.5	15	17.5	20	22.5	25
T	7	7	7 12	12	12	12

Design and specifications presented here are for the standard parts only. Please kindly contact us for your special requests and ask for the current technical specifications before purchase and/or use.

[Back to top](#)

Mouser Electronics

Authorized Distributor

Click to View Pricing, Inventory, Delivery & Lifecycle Information:

Alpha (Taiwan):

[RV110F-40-15A-A10K](#) [RV110F-40-20B-A10K](#) [RV110F-20-15B-A10K](#) [RV110F-40-15B-A10K-0020](#) [RV110F-20-15B-B10K](#) [RV110F-20-15A-B100K](#) [RV110F-40-15A-B100K](#) [RV110F-20-15B-A100K](#) [RV110F-20-15B-B100K](#) [RV110F-40-15B-B100K](#) [RV110F-40-15A-B10K](#) [RV110F-20-15A-A100K](#) [RV110F-40-20B-B10K](#) [RV110F-40-15B-B10K](#) [RV110F-40-15A-A100K](#) [RV110F-40-20B-A100K](#) [RV110F-20-15A-B10K](#) [RV110F-20-15A-A10K](#) [RV110F-40-15B-A100K](#) [RV110F-20-20B-A10K](#) [RV110F-20-20B-A100K](#) [RV110F-20-20B-B10K](#) [RV110F-20-20B-B100K](#) [RV110F-40-20B-B100K](#)

Компания «Океан Электроники» предлагает заключение долгосрочных отношений при поставках импортных электронных компонентов на взаимовыгодных условиях!

Наши преимущества:

- Поставка оригинальных импортных электронных компонентов напрямую с производств Америки, Европы и Азии, а так же с крупнейших складов мира;
- Широкая линейка поставок активных и пассивных импортных электронных компонентов (более 30 млн. наименований);
- Поставка сложных, дефицитных, либо снятых с производства позиций;
- Оперативные сроки поставки под заказ (от 5 рабочих дней);
- Экспресс доставка в любую точку России;
- Помощь Конструкторского Отдела и консультации квалифицированных инженеров;
- Техническая поддержка проекта, помощь в подборе аналогов, поставка прототипов;
- Поставка электронных компонентов под контролем ВП;
- Система менеджмента качества сертифицирована по Международному стандарту ISO 9001;
- При необходимости вся продукция военного и аэрокосмического назначения проходит испытания и сертификацию в лаборатории (по согласованию с заказчиком);
- Поставка специализированных компонентов военного и аэрокосмического уровня качества (Xilinx, Altera, Analog Devices, Intersil, Interpoint, Microsemi, Actel, Aeroflex, Peregrine, VPT, Syfer, Eurofarad, Texas Instruments, MS Kennedy, Miteq, Cobham, E2V, MA-COM, Hittite, Mini-Circuits, General Dynamics и др.);

Компания «Океан Электроники» является официальным дистрибьютором и эксклюзивным представителем в России одного из крупнейших производителей разъемов военного и аэрокосмического назначения «JONHON», а так же официальным дистрибьютором и эксклюзивным представителем в России производителя высокотехнологичных и надежных решений для передачи СВЧ сигналов «FORSTAR».



JONHON

«JONHON» (основан в 1970 г.)

Разъемы специального, военного и аэрокосмического назначения:

(Применяются в военной, авиационной, аэрокосмической, морской, железнодорожной, горно- и нефтедобывающей отраслях промышленности)

«FORSTAR» (основан в 1998 г.)

ВЧ соединители, коаксиальные кабели, кабельные сборки и микроволновые компоненты:

(Применяются в телекоммуникациях гражданского и специального назначения, в средствах связи, РЛС, а так же военной, авиационной и аэрокосмической отраслях промышленности).



Телефон: 8 (812) 309-75-97 (многоканальный)

Факс: 8 (812) 320-03-32

Электронная почта: ocean@oceanchips.ru

Web: <http://oceanchips.ru/>

Адрес: 198099, г. Санкт-Петербург, ул. Калинина, д. 2, корп. 4, лит. А