

N-Channel Enhancement-Mode Vertical DMOS FET

Features

- Free from Secondary Breakdown
- Low Power Drive Requirement
- Ease of Paralleling
- Low C_{ISS} and Fast Switching Speeds
- Excellent Thermal Stability
- Integral Source-drain Diode
- High Input Impedance and High Gain

Applications

- Motor Controls
- Converters
- Amplifiers
- Switches
- Power Supply Circuits
- Drivers (Relays, Hammers, Solenoids, Lamps, Memory, Displays, Bipolar Transistors, etc.)

General Description

VN2210 is an Enhancement-mode (normally-off) transistor that utilizes a vertical Double-diffused Metal-Oxide Semiconductor (DMOS) structure and a well-proven silicon gate manufacturing process. This combination produces a device with the power handling capabilities of bipolar transistors as well as the high input impedance and positive temperature coefficient inherent in MOS devices. Characteristic of all MOS structures, this device is free from thermal runaway and thermally induced secondary breakdown.

Vertical DMOS Field-Effect Transistors (FETs) are ideally suited to a wide range of switching and amplifying applications where high breakdown voltage, high input impedance, low input capacitance and fast switching speeds are desired.

Package Types

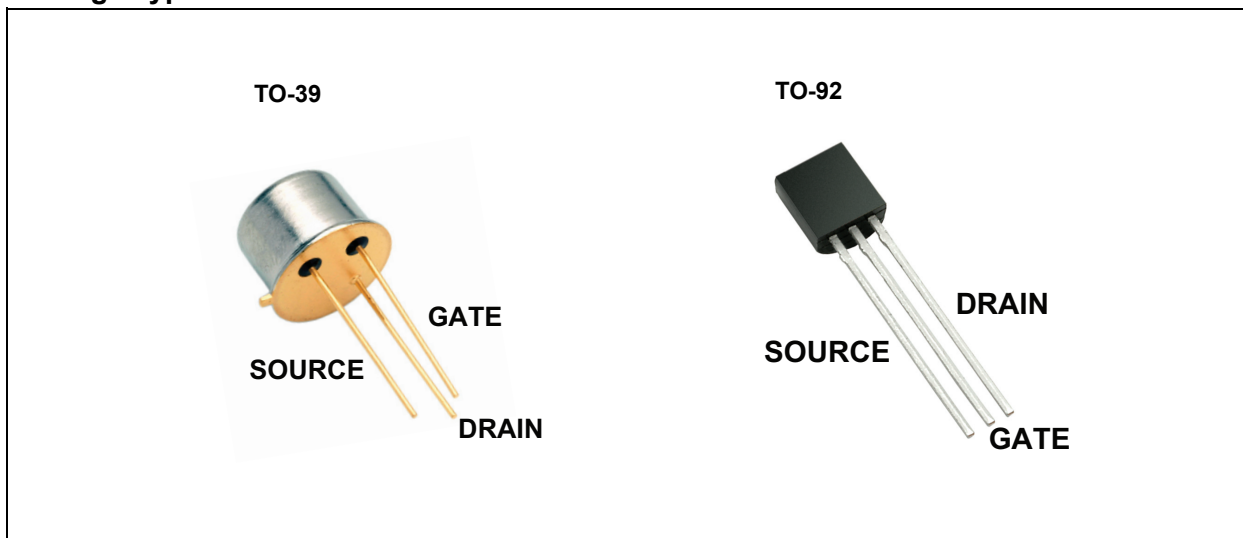

VN2210

1.0 ELECTRICAL CHARACTERISTICS

Absolute Maximum Ratings †

Drain-to-source Voltage	BV_{DSS}
Drain-to-gate Voltage	BV_{DGS}
Gate-to-source Voltage	$\pm 20V$
Operating and Storage Temperatures	$-55^{\circ}C$ to $+150^{\circ}C$

† **Notice:** Stresses above those listed under “Absolute Maximum Ratings” may cause permanent damage to the device. This is a stress rating only, and functional operation of the device at those or any other conditions above those indicated in the operational sections of this specification is not intended. Exposure to maximum rating conditions for extended periods may affect device reliability.

ELECTRICAL CHARACTERISTICS

Electrical Specifications: $T_A = 25^{\circ}C$ unless otherwise specified.						
Parameters	Sym.	Min.	Typ.	Max.	Units	Conditions
DC PARAMETERS (Note 1 unless otherwise specified)						
Drain-to-source Breakdown Voltage	BV_{DSS}	100	—	—	V	$V_{GS} = 0V, I_D = 10\text{ mA}$
Gate Threshold Voltage	$V_{GS(th)}$	0.8	—	2.4	V	$V_{GS} = V_{DS}, I_D = 10\text{ mA}$
Change in $V_{GS(th)}$ with Temperature	$\Delta V_{GS(th)}$	—	-4.3	-5.5	mV/ $^{\circ}C$	$V_{GS} = V_{DS}, I_D = 10\text{ mA}$ (Note 2)
Gate Body Leakage Current	I_{GSS}	—	—	100	nA	$V_{GS} = \pm 20V, V_{DS} = 0V$
Zero Gate Voltage Drain Current	I_{DSS}	—	—	50	μA	$V_{GS} = 0V, V_{DS} = \text{Maximum rating}$
		—	—	10	mA	$V_{DS} = 0.8$ maximum rating, $V_{GS} = 0V, T_A = 125^{\circ}C$ (Note 2)
ON-State Drain Current	$I_{D(ON)}$	3	4.5	—	A	$V_{GS} = 5V, V_{DS} = 25V$
		8	17	—		$V_{GS} = 10V, V_{DS} = 25V$
Static Drain-to-source ON-State Resistance	$R_{DS(ON)}$	—	0.4	0.5	Ω	$V_{GS} = 5V, I_D = 1A$
		—	0.27	0.35		$V_{GS} = 10V, I_D = 4A$
Change in $R_{DS(ON)}$ with Temperature	$\Delta R_{DS(ON)}$	—	0.85	1.2	$\%/^{\circ}C$	$V_{GS} = 10V, I_D = 4A$ (Note 2)
AC PARAMETERS (Note 2)						
Forward Transconductance	G_{FS}	1200	—	—	mmho	$V_{DS} = 25V, I_D = 2A$
Input Capacitance	C_{ISS}	—	300	500	pF	$V_{GS} = 0V, V_{DS} = 25V, f = 1\text{ MHz}$
Common Source Output Capacitance	C_{OSS}	—	125	200		
Reverse Transfer Capacitance	C_{RSS}	—	50	65		
Turn-on Time	$t_{d(ON)}$	—	10	15	ns	$V_{DD} = 25V, I_D = 2A, R_{GEN} = 10\Omega$
Rise Time	t_r	—	10	15		
Turn-off Time	$t_{d(OFF)}$	—	50	65		
Fall Time	t_f	—	30	50		
DIODE PARAMETERS						
Diode Forward Voltage Drop	V_{SD}	—	1	1.6	V	$V_{GS} = 0V, I_{SD} = 4A$ (Note 1)
Reverse Recovery Time	t_{rr}	—	500	—	ns	$V_{GS} = 0V, I_{SD} = 1A$ (Note 2)

Note 1: All DC parameters are 100% tested at $25^{\circ}C$ unless otherwise stated.
(Pulse test: 300 μs pulse, 2% duty cycle)

2: Specification is obtained by characterization and is not 100% tested.

TEMPERATURE SPECIFICATIONS

Electrical Characteristics: Unless otherwise specified, for all specifications $T_A = T_J = +25^\circ\text{C}$.						
Parameters	Sym.	Min.	Typ.	Max.	Units	Conditions
TEMPERATURE RANGES						
Operating Temperature	T_A	-55	—	+150	$^\circ\text{C}$	
Storage Temperature	T_S	-55	—	+150	$^\circ\text{C}$	
PACKAGE THERMAL RESISTANCES						
TO-39	θ_{JA}	—	N/A	—	—	
TO-92	θ_{JA}	—	132	—	$^\circ\text{C/W}$	

THERMAL CHARACTERISTICS

Package	I_D (Note 1) (Continuous) (A)	I_D (Pulsed) (A)	Power Dissipation at $T_C = 25^\circ\text{C}$ (W)	I_{DR} (Note 1) (A)	I_{DRM} (A)
TO-39	1.7	10	0.36	1.7	10
TO-92	1.2	8	0.74	1.2	8

Note 1: I_D (continuous) is limited by maximum T_j .

2.0 TYPICAL PERFORMANCE CURVES

Note: The graphs and tables provided following this note are a statistical summary based on a limited number of samples and are provided for informational purposes only. The performance characteristics listed herein are not tested or guaranteed. In some graphs or tables, the data presented may be outside the specified operating range (e.g. outside specified power supply range) and therefore outside the warranted range.

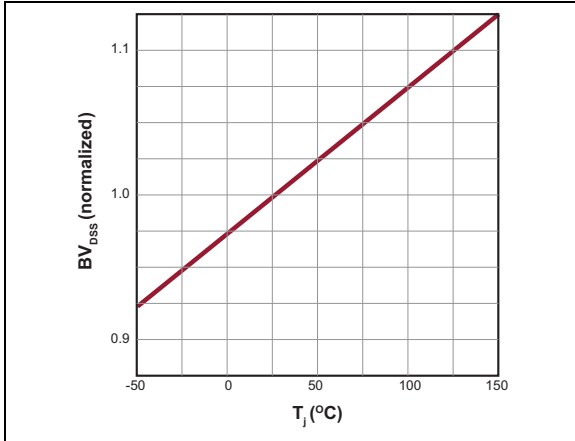

FIGURE 2-1: BV_{DSS} Variation with Temperature.

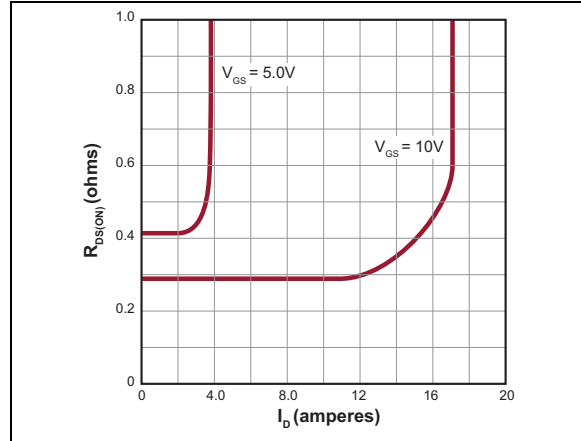

FIGURE 2-4: On-resistance vs. Drain Current.

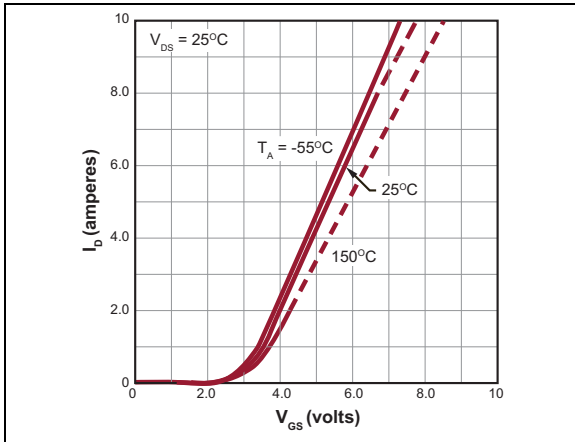

FIGURE 2-2: Transfer Characteristics.

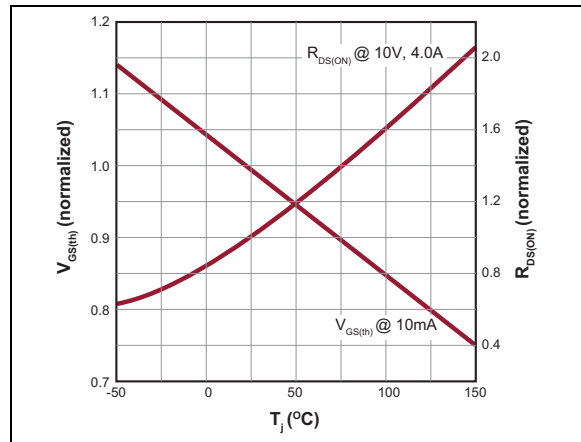

FIGURE 2-5: V_{GS} and R_{DS} Variation with Temperature.

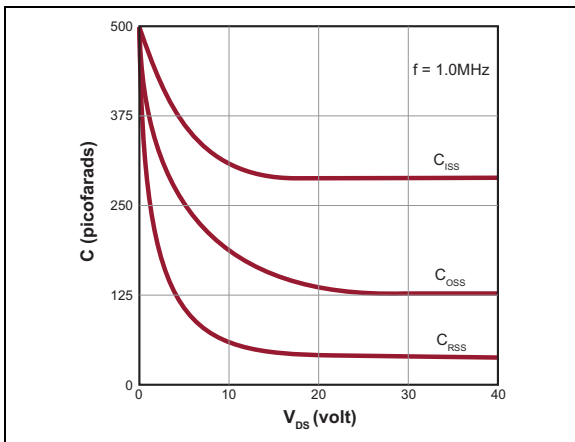

FIGURE 2-3: Capacitance vs. Drain-to-source Voltage.

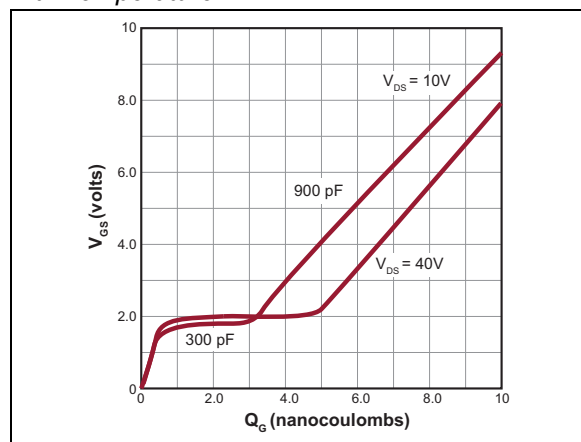

FIGURE 2-6: Gate Drive Dynamic Characteristics.

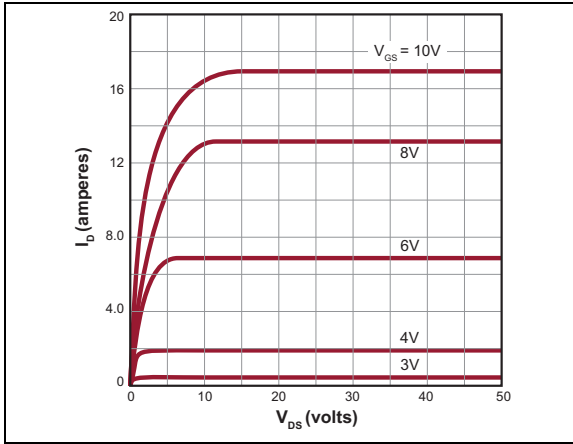

FIGURE 2-7: Output Characteristics.

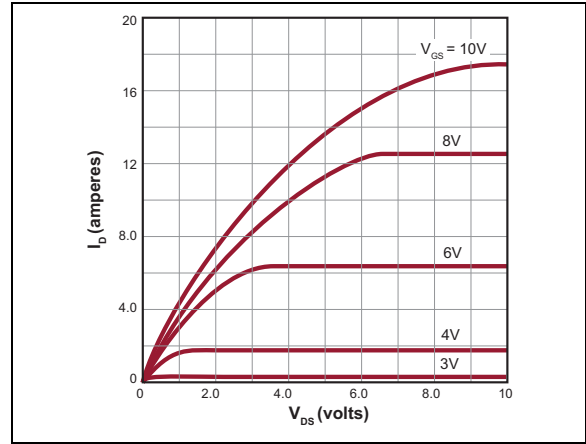

FIGURE 2-10: Saturation Characteristics.

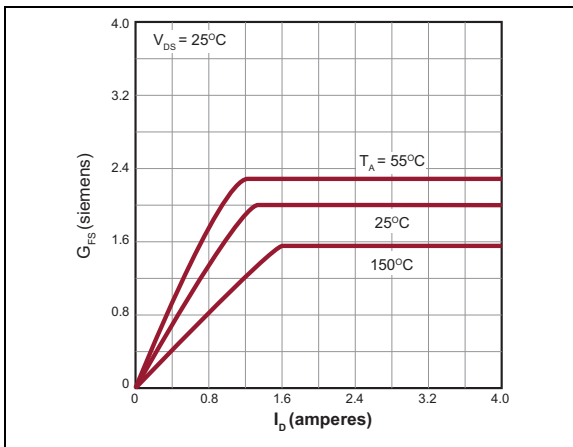

FIGURE 2-8: Transconductance vs. Drain Current.

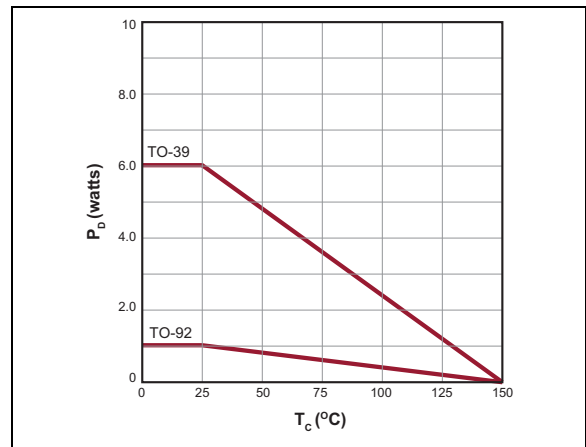

FIGURE 2-11: Power Dissipation vs. Case Temperature.

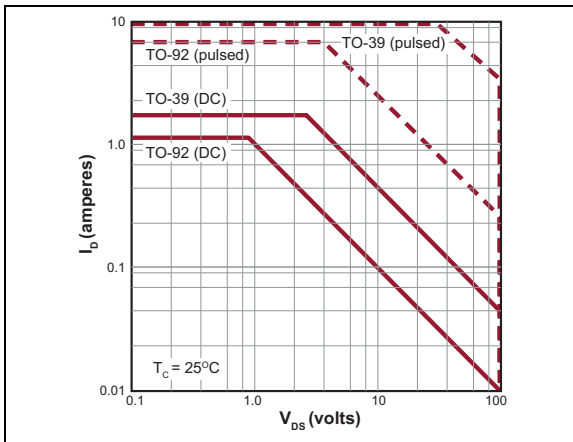

FIGURE 2-9: Maximum Rated Safe Operating Area.

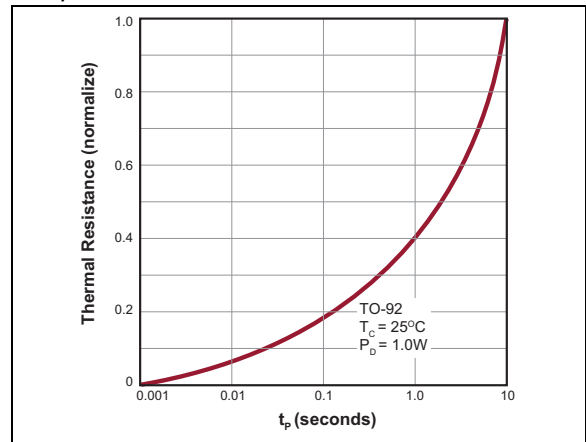

FIGURE 2-12: Thermal Response Characteristics.

VN2210

3.0 PIN DESCRIPTION

Table 3-1 shows the description of pins in TO-39 and TO-92.

TABLE 3-1: TO-39/TO-92 PIN FUNCTION TABLE

Pin Number	TO-39	TO-92	Description
1	Source	Source	Source
2	Gate	Gate	Gate
3	Drain	Drain	Drain

4.0 FUNCTIONAL DESCRIPTION

Figure 4-1 illustrates the switching waveforms and test circuit for VN2210.

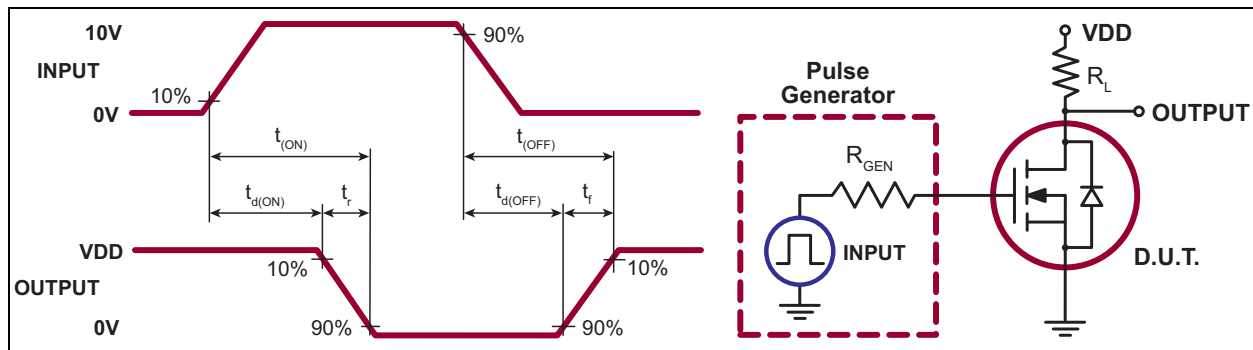

FIGURE 4-1: Switching Waveforms and Test Circuit.

PRODUCT SUMMARY

BV_{DSS}/BV_{DGS} (V)	$R_{DS(ON)}$ (Maximum) (Ω)	$V_{GS(th)}$ (Maximum) (V)
100	0.35	2.4

VN2210

5.0 PACKAGING INFORMATION

5.1 Package Marking Information

3-Lead TO-39

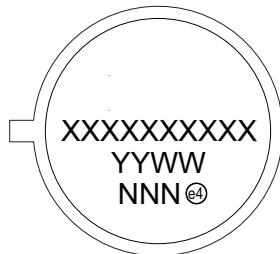

Example

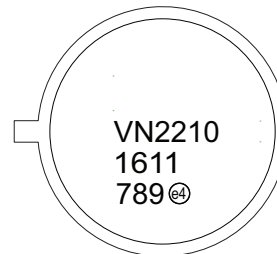

3-lead TO-92

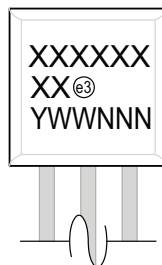

Example

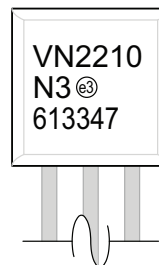

Legend:	XX...X	Product Code or Customer-specific information
	Y	Year code (last digit of calendar year)
	YY	Year code (last 2 digits of calendar year)
	WW	Week code (week of January 1 is week '01')
	NNN	Alphanumeric traceability code
	(e3)	Pb-free JEDEC [®] designator for Matte Tin (Sn)
	*	This package is Pb-free. The Pb-free JEDEC designator (e3) can be found on the outer packaging for this package.
	(e4)	Pre-plated
Note:	In the event the full Microchip part number cannot be marked on one line, it will be carried over to the next line, thus limiting the number of available characters for product code or customer-specific information. Package may or not include the corporate logo.	

3-Lead TO-39 Package Outline (N2)

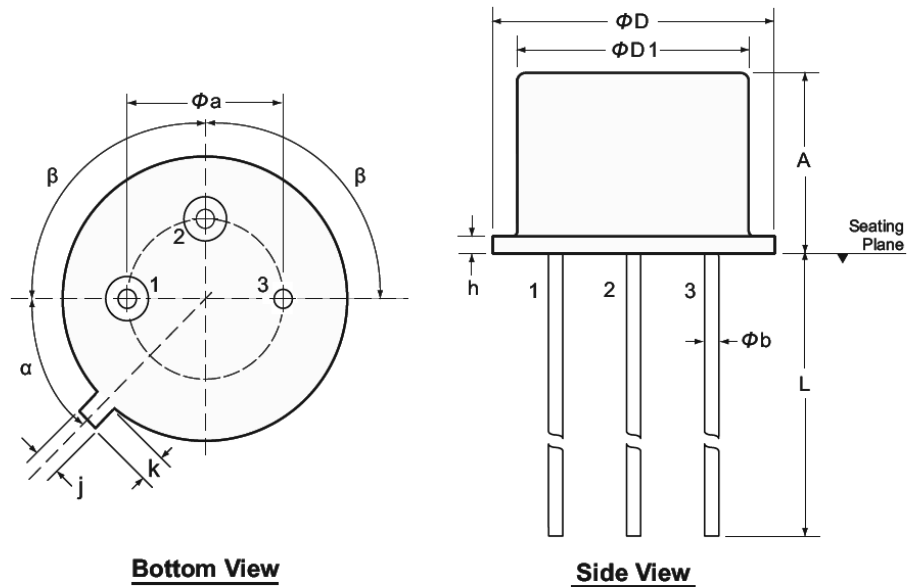

Note: For the most current package drawings, see the Microchip Packaging Specification at www.microchip.com/packaging.

Symbol	α	β	A	ϕa	ϕb	ϕD	$\phi D1$	h	j	k	L	
Dimension (inches)	MIN	45° NOM	90° NOM	.240	.190	.016	.350	.315	.009	.028	.029	.500
	NOM			-	-	-	-	-	-	-	-	-
	MAX			.260	.210	.021	.370	.335	.125	.034	.040	.560*

JEDEC Registration TO-39.

* This dimension is not specified in the JEDEC drawing.

Drawings not to scale.

3-Lead TO-92 Package Outline (L/LL/N3)

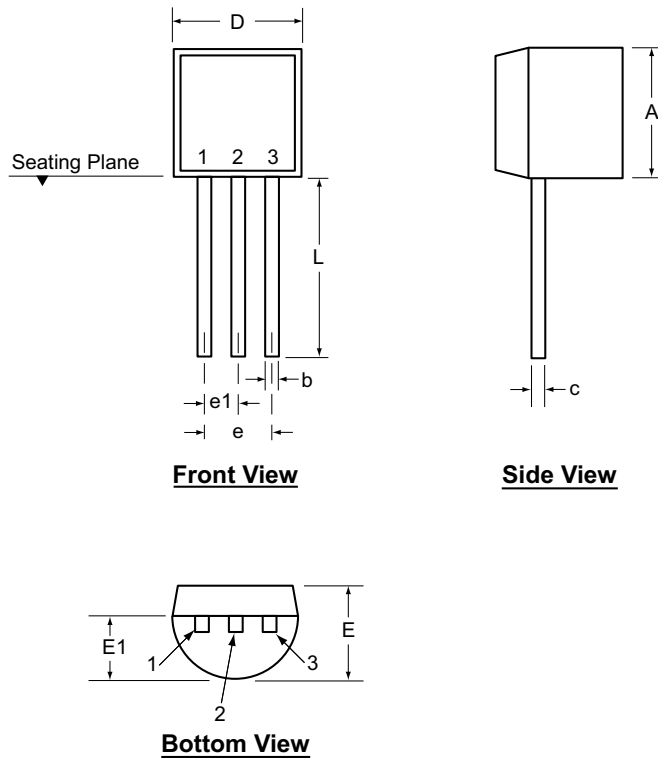

Note: For the most current package drawings, see the Microchip Packaging Specification at www.microchip.com/packaging.

Symbol	A	b	c	D	E	E1	e	e1	L	
Dimensions (inches)	MIN	.170	.014 [†]	.014 [†]	.175	.125	.080	.095	.045	.500
	NOM	-	-	-	-	-	-	-	-	-
	MAX	.210	.022 [†]	.022 [†]	.205	.165	.105	.105	.055	.610*

JEDEC Registration TO-92.

* This dimension is not specified in the JEDEC drawing.

† This dimension differs from the JEDEC drawing.

Drawings not to scale.

APPENDIX A: REVISION HISTORY

Revision A (June 2016)

- Converted Supertex Doc# DSFP-VN2210 to Microchip DS20005559A.
- Made minor text changes throughout the document.

PRODUCT IDENTIFICATION SYSTEM

To order or obtain information, e.g., on pricing or delivery, contact your local Microchip representative or sales office.

<u>PART NO.</u>	<u>XX</u>	-	<u>X</u>	-	<u>X</u>
Device	Package Options		Environmental		Media Type
Device:	VN2210	=	N-Channel Enhancement-Mode Vertical DMOS FET		
Packages:	N2	=	3-lead TO-39		
	N3	=	3-lead TO-92		
Environmental:	G	=	Lead (Pb)-free/RoHS-compliant Package		
Media Type:	(blank)	=	500/Bag for N2 Package 1000/Bag for N3 Package		
<p>Note: VN2210N2 does not include a "-G" designator. However, the package is an RoHS-compliant product.</p>					
Examples:					
a) VN2210N2: N-Channel Enhancement-Mode Vertical DMOS FET, 3-lead TO-39 Package, 500/Bag					
b) VN2210N3-G: N-Channel Enhancement-Mode Vertical DMOS FET, 3-lead TO-92 Package, 1000/Bag					

Note the following details of the code protection feature on Microchip devices:

- Microchip products meet the specification contained in their particular Microchip Data Sheet.
- Microchip believes that its family of products is one of the most secure families of its kind on the market today, when used in the intended manner and under normal conditions.
- There are dishonest and possibly illegal methods used to breach the code protection feature. All of these methods, to our knowledge, require using the Microchip products in a manner outside the operating specifications contained in Microchip's Data Sheets. Most likely, the person doing so is engaged in theft of intellectual property.
- Microchip is willing to work with the customer who is concerned about the integrity of their code.
- Neither Microchip nor any other semiconductor manufacturer can guarantee the security of their code. Code protection does not mean that we are guaranteeing the product as “unbreakable.”

Code protection is constantly evolving. We at Microchip are committed to continuously improving the code protection features of our products. Attempts to break Microchip's code protection feature may be a violation of the Digital Millennium Copyright Act. If such acts allow unauthorized access to your software or other copyrighted work, you may have a right to sue for relief under that Act.

Information contained in this publication regarding device applications and the like is provided only for your convenience and may be superseded by updates. It is your responsibility to ensure that your application meets with your specifications. MICROCHIP MAKES NO REPRESENTATIONS OR WARRANTIES OF ANY KIND WHETHER EXPRESS OR IMPLIED, WRITTEN OR ORAL, STATUTORY OR OTHERWISE, RELATED TO THE INFORMATION, INCLUDING BUT NOT LIMITED TO ITS CONDITION, QUALITY, PERFORMANCE, MERCHANTABILITY OR FITNESS FOR PURPOSE. Microchip disclaims all liability arising from this information and its use. Use of Microchip devices in life support and/or safety applications is entirely at the buyer's risk, and the buyer agrees to defend, indemnify and hold harmless Microchip from any and all damages, claims, suits, or expenses resulting from such use. No licenses are conveyed, implicitly or otherwise, under any Microchip intellectual property rights unless otherwise stated.

Microchip received ISO/TS-16949:2009 certification for its worldwide headquarters, design and wafer fabrication facilities in Chandler and Tempe, Arizona; Gresham, Oregon and design centers in California and India. The Company's quality system processes and procedures are for its PIC® MCUs and dsPIC® DSCs, KEELOQ® code hopping devices, Serial EEPROMs, microperipherals, nonvolatile memory and analog products. In addition, Microchip's quality system for the design and manufacture of development systems is ISO 9001:2000 certified.

**QUALITY MANAGEMENT SYSTEM
CERTIFIED BY DNV
= ISO/TS 16949 =**

Trademarks

The Microchip name and logo, the Microchip logo, AnyRate, dsPIC, FlashFlex, flexPWR, Heldo, JukeBlox, KeeLoq, KeeLoq logo, Klear, LANCheck, LINK MD, MediaLB, MOST, MOST logo, MPLAB, OptoLyzer, PIC, PICSTART, PIC32 logo, RightTouch, SpyNIC, SST, SST Logo, SuperFlash and UNI/O are registered trademarks of Microchip Technology Incorporated in the U.S.A. and other countries.

ClockWorks, The Embedded Control Solutions Company, ETHERSYNCH, Hyper Speed Control, HyperLight Load, IntelliMOS, mTouch, Precision Edge, and QUIET-WIRE are registered trademarks of Microchip Technology Incorporated in the U.S.A.

Analog-for-the-Digital Age, Any Capacitor, AnyIn, AnyOut, BodyCom, chipKIT, chipKIT logo, CodeGuard, dsPICDEM, dsPICDEM.net, Dynamic Average Matching, DAM, ECAN, EtherGREEN, In-Circuit Serial Programming, ICSP, Inter-Chip Connectivity, JitterBlocker, KlearNet, KlearNet logo, MiWi, motorBench, MPASM, MPF, MPLAB Certified logo, MPLIB, MPLINK, MultiTRAK, NetDetach, Omniscient Code Generation, PICDEM, PICDEM.net, PICkit, PICtail, PureSilicon, RightTouch logo, REAL ICE, Ripple Blocker, Serial Quad I/O, SQL, SuperSwitcher, SuperSwitcher II, Total Endurance, TSHARC, USBCheck, VariSense, ViewSpan, WiperLock, Wireless DNA, and ZENA are trademarks of Microchip Technology Incorporated in the U.S.A. and other countries.

SQTP is a service mark of Microchip Technology Incorporated in the U.S.A.

Silicon Storage Technology is a registered trademark of Microchip Technology Inc. in other countries.

GestIC is a registered trademarks of Microchip Technology Germany II GmbH & Co. KG, a subsidiary of Microchip Technology Inc., in other countries.

All other trademarks mentioned herein are property of their respective companies.

© 2016, Microchip Technology Incorporated, Printed in the U.S.A., All Rights Reserved.

ISBN: 978-1-5224-0686-0



MICROCHIP

Worldwide Sales and Service

AMERICAS

Corporate Office
2355 West Chandler Blvd.
Chandler, AZ 85224-6199
Tel: 480-792-7200
Fax: 480-792-7277
Technical Support:
<http://www.microchip.com/support>
Web Address:
www.microchip.com

Atlanta
Duluth, GA
Tel: 678-957-9614
Fax: 678-957-1455

Austin, TX
Tel: 512-257-3370

Boston
Westborough, MA
Tel: 774-760-0087
Fax: 774-760-0088

Chicago
Itasca, IL
Tel: 630-285-0071
Fax: 630-285-0075

Cleveland
Independence, OH
Tel: 216-447-0464
Fax: 216-447-0643

Dallas
Addison, TX
Tel: 972-818-7423
Fax: 972-818-2924

Detroit
Novi, MI
Tel: 248-848-4000

Houston, TX
Tel: 281-894-5983

Indianapolis
Noblesville, IN
Tel: 317-773-8323
Fax: 317-773-5453

Los Angeles
Mission Viejo, CA
Tel: 949-462-9523
Fax: 949-462-9608

New York, NY
Tel: 631-435-6000

San Jose, CA
Tel: 408-735-9110

Canada - Toronto
Tel: 905-673-0699
Fax: 905-673-6509

ASIA/PACIFIC

Asia Pacific Office
Suites 3707-14, 37th Floor
Tower 6, The Gateway
Harbour City, Kowloon

Hong Kong
Tel: 852-2943-5100
Fax: 852-2401-3431

Australia - Sydney
Tel: 61-2-9868-6733
Fax: 61-2-9868-6755

China - Beijing
Tel: 86-10-8569-7000
Fax: 86-10-8528-2104

China - Chengdu
Tel: 86-28-8665-5511
Fax: 86-28-8665-7889

China - Chongqing
Tel: 86-23-8980-9588
Fax: 86-23-8980-9500

China - Dongguan
Tel: 86-769-8702-9880

China - Hangzhou
Tel: 86-571-8792-8115
Fax: 86-571-8792-8116

China - Hong Kong SAR
Tel: 852-2943-5100
Fax: 852-2401-3431

China - Nanjing
Tel: 86-25-8473-2460
Fax: 86-25-8473-2470

China - Qingdao
Tel: 86-532-8502-7355
Fax: 86-532-8502-7205

China - Shanghai
Tel: 86-21-5407-5533
Fax: 86-21-5407-5066

China - Shenyang
Tel: 86-24-2334-2829
Fax: 86-24-2334-2393

China - Shenzhen
Tel: 86-755-8864-2200
Fax: 86-755-8203-1760

China - Wuhan
Tel: 86-27-5980-5300
Fax: 86-27-5980-5118

China - Xian
Tel: 86-29-8833-7252
Fax: 86-29-8833-7256

ASIA/PACIFIC

China - Xiamen
Tel: 86-592-2388138
Fax: 86-592-2388130

China - Zhuhai
Tel: 86-756-3210040
Fax: 86-756-3210049

India - Bangalore
Tel: 91-80-3090-4444
Fax: 91-80-3090-4123

India - New Delhi
Tel: 91-11-4160-8631
Fax: 91-11-4160-8632

India - Pune
Tel: 91-20-3019-1500

Japan - Osaka
Tel: 81-6-6152-7160
Fax: 81-6-6152-9310

Japan - Tokyo
Tel: 81-3-6880-3770
Fax: 81-3-6880-3771

Korea - Daegu
Tel: 82-53-744-4301
Fax: 82-53-744-4302

Korea - Seoul
Tel: 82-2-554-7200
Fax: 82-2-558-5932 or
82-2-558-5934

Malaysia - Kuala Lumpur
Tel: 60-3-6201-9857
Fax: 60-3-6201-9859

Malaysia - Penang
Tel: 60-4-227-8870
Fax: 60-4-227-4068

Philippines - Manila
Tel: 63-2-634-9065
Fax: 63-2-634-9069

Singapore
Tel: 65-6334-8870
Fax: 65-6334-8850

Taiwan - Hsin Chu
Tel: 886-3-5778-366
Fax: 886-3-5770-955

Taiwan - Kaohsiung
Tel: 886-7-213-7828

Taiwan - Taipei
Tel: 886-2-2508-8600
Fax: 886-2-2508-0102

Thailand - Bangkok
Tel: 66-2-694-1351
Fax: 66-2-694-1350

EUROPE

Austria - Wels
Tel: 43-7242-2244-39
Fax: 43-7242-2244-393

Denmark - Copenhagen
Tel: 45-4450-2828
Fax: 45-4485-2829

France - Paris
Tel: 33-1-69-53-63-20
Fax: 33-1-69-30-90-79

Germany - Dusseldorf
Tel: 49-2129-3766400

Germany - Karlsruhe
Tel: 49-721-625370

Germany - Munich
Tel: 49-89-627-144-0
Fax: 49-89-627-144-44

Italy - Milan
Tel: 39-0331-742611
Fax: 39-0331-466781

Italy - Venice
Tel: 39-049-7625286

Netherlands - Drunen
Tel: 31-416-690399
Fax: 31-416-690340

Poland - Warsaw
Tel: 48-22-3325737

Spain - Madrid
Tel: 34-91-708-08-90
Fax: 34-91-708-08-91

Sweden - Stockholm
Tel: 46-8-5090-4654

UK - Wokingham
Tel: 44-118-921-5800
Fax: 44-118-921-5820

07/14/15

Mouser Electronics

Authorized Distributor

Click to View Pricing, Inventory, Delivery & Lifecycle Information:

Microchip:

[VN2210N3-P013-G](#) [VN2210N3-P003-G](#) [VN2210N3-G](#) [VN2210N3-P002-G](#) [VN2210N3-P013](#) [VN2210N3-P014](#)
[VN2210N2](#) [VN2210N3-P002](#) [VN2210N3-P003](#) [VN2210N3](#) [VN2210N3-P014-G](#) [VN2210N3-G P005](#) [VN2210N3-G](#)
[P002](#) [VN2210N3-G P013](#) [VN2210N3-G P014](#) [VN2210N3-G P003](#)

Компания «Океан Электроники» предлагает заключение долгосрочных отношений при поставках импортных электронных компонентов на взаимовыгодных условиях!

Наши преимущества:

- Поставка оригинальных импортных электронных компонентов напрямую с производств Америки, Европы и Азии, а так же с крупнейших складов мира;
- Широкая линейка поставок активных и пассивных импортных электронных компонентов (более 30 млн. наименований);
- Поставка сложных, дефицитных, либо снятых с производства позиций;
- Оперативные сроки поставки под заказ (от 5 рабочих дней);
- Экспресс доставка в любую точку России;
- Помощь Конструкторского Отдела и консультации квалифицированных инженеров;
- Техническая поддержка проекта, помощь в подборе аналогов, поставка прототипов;
- Поставка электронных компонентов под контролем ВП;
- Система менеджмента качества сертифицирована по Международному стандарту ISO 9001;
- При необходимости вся продукция военного и аэрокосмического назначения проходит испытания и сертификацию в лаборатории (по согласованию с заказчиком);
- Поставка специализированных компонентов военного и аэрокосмического уровня качества (Xilinx, Altera, Analog Devices, Intersil, Interpoint, Microsemi, Actel, Aeroflex, Peregrine, VPT, Syfer, Eurofarad, Texas Instruments, MS Kennedy, Miteq, Cobham, E2V, MA-COM, Hittite, Mini-Circuits, General Dynamics и др.);

Компания «Океан Электроники» является официальным дистрибьютором и эксклюзивным представителем в России одного из крупнейших производителей разъемов военного и аэрокосмического назначения «**JONHON**», а так же официальным дистрибьютором и эксклюзивным представителем в России производителя высокотехнологичных и надежных решений для передачи СВЧ сигналов «**FORSTAR**».



JONHON

«**JONHON**» (основан в 1970 г.)

Разъемы специального, военного и аэрокосмического назначения:

(Применяются в военной, авиационной, аэрокосмической, морской, железнодорожной, горно- и нефтедобывающей отраслях промышленности)

«**FORSTAR**» (основан в 1998 г.)

ВЧ соединители, коаксиальные кабели, кабельные сборки и микроволновые компоненты:

(Применяются в телекоммуникациях гражданского и специального назначения, в средствах связи, РЛС, а так же военной, авиационной и аэрокосмической отраслях промышленности).



Телефон: 8 (812) 309-75-97 (многоканальный)

Факс: 8 (812) 320-03-32

Электронная почта: ocean@oceanchips.ru

Web: <http://oceanchips.ru/>

Адрес: 198099, г. Санкт-Петербург, ул. Калинина, д. 2, корп. 4, лит. А