



AC/DC Converter
Non-Isolation Buck Converter PWM method
2 W 12 V
BM2P129TF Reference Board

User's Guide

<High Voltage Safety Precautions>

- ◇ Read all safety precautions before use

Please note that this document covers only the BM2P129TF evaluation board (BM2P129TF-EVK-001) and its functions. For additional information, please refer to the datasheet.

To ensure safe operation, please carefully read all precautions before handling the evaluation board



Depending on the configuration of the board and voltages used,

Potentially lethal voltages may be generated.

Therefore, please make sure to read and observe all safety precautions described in the red box below.

Before Use

- [1] Verify that the parts/components are not damaged or missing (i.e. due to the drops).
- [2] Check that there are no conductive foreign objects on the board.
- [3] Be careful when performing soldering on the module and/or evaluation board to ensure that solder splash does not occur.
- [4] Check that there is no condensation or water droplets on the circuit board.

During Use

- [5] Be careful to not allow conductive objects to come into contact with the board.
- [6] **Brief accidental contact or even bringing your hand close to the board may result in discharge and lead to severe injury or death.**

Therefore, DO NOT touch the board with your bare hands or bring them too close to the board. In addition, as mentioned above please exercise extreme caution when using conductive tools such as tweezers and screwdrivers.

- [7] If used under conditions beyond its rated voltage, it may cause defects such as short-circuit or, depending on the circumstances, explosion or other permanent damages.
- [8] Be sure to wear insulated gloves when handling is required during operation.

After Use

- [9] The ROHM Evaluation Board contains the circuits which store the high voltage. Since it stores the charges even after the connected power circuits are cut, please discharge the electricity after using it, and please deal with it after confirming such electric discharge.
- [10] Protect against electric shocks by wearing insulated gloves when handling.

This evaluation board is intended for use only in research and development facilities and should be handled **only by qualified personnel familiar with all safety and operating procedures.**

We recommend carrying out operation in a safe environment that includes the use of high voltage signage at all entrances, safety interlocks, and protective glasses.

AC/DC Converter Non-Isolation Buck Converter PWM method Output 2 W 12 V **BM2P129TF Reference Board** BM2P129TF-EVK-001

The BM2P129TF-EVK-001 evaluation board outputs 12 V voltage from the input of 90 Vac to 264 Vac. The output current supplies up to 0.167 A. BM2P129TF which is PWM method DC/DC converter IC built-in 650 V MOSFET is used.

The BM2P129TF contributes to low power consumption by built-in a 650 V starting circuit. Built-in current detection resistor realizes compact power supply design.

Current mode control imposes current limitation on every cycle, providing superior performance in bandwidth and transient response.

The switching frequency is 100 kHz in fixed mode. At light load, frequency is reduced and high efficiency is realized. Built-in frequency hopping function contributes to low EMI. Low on-resistance 9.5 Ω 650 V MOSFET built-in contributes to low power consumption and easy design.



Figure 1. BM2P129TF-EVK-001

Electronics Characteristics

Not guarantee the characteristics, is representative value.

Unless otherwise noted : $V_{IN} = 230 \text{ Vac}$, $I_{OUT} = 167 \text{ mA}$, $T_a: 25 \text{ }^\circ\text{C}$

Parameter	Min	Typ	Max	Units	Conditions
Input Voltage Range	90	230	264	Vac	
Input Frequency	47	50/60	63	Hz	
Output Voltage	10.8	12.0	13.2	V	
Maximum Output Power	-	-	2.0	W	$I_{OUT} = 167 \text{ mA}$
Output Current Range (NOTE1)	2	100	167	mA	
Stand-by Power	-	30	-	mW	$I_{OUT} = 0 \text{ A}$
Efficiency	-	76.1	-	%	$I_{OUT} = 167 \text{ mA}$
Output Ripple Voltage (NOTE2)	-	38	-	mVpp	
Operating Temperature Range	-10	+25	+65	$^\circ\text{C}$	

(NOTE1) Please adjust operating time, within any parts surface temperature under 105 $^\circ\text{C}$

(NOTE2) Not include spike noise

Operation Procedure

1. Operation Equipment

- (1) AC Power supply 90 Vac~264 Vac, over 10W
- (2) Electronic Load capacity 0.167 A
- (3) Multi meter

2. Connect method

- (1) AC power supply presetting range 90~264 Vac, Output switch is off.
- (2) Load setting under 0.167 A. Load switch is off.
- (3) AC power supply N terminal connect to the board AC (N) of CN1, and L terminal connect to AC(L).
- (4) Load + terminal connect to VOUT, GND terminal connect to GND terminal
- (5) AC power meter connect between AC power supply and board.
- (6) Output test equipment connects to output terminal
- (7) AC power supply switch ON.
- (8) Check that output voltage is 12 V.
- (9) Electronic load switch ON
- (10) Check output voltage drop by load connect wire resistance



CN1: from the top AC (L), AC (N)

Figure 2. Connection Circuit

Deleting

Maximum Output Power P_o of this reference board is 2 W. The derating curve is shown on the right. If ambient temperature is over 55 °C, Please adjust load continuous time by over 105 °C of any parts surface temperature.

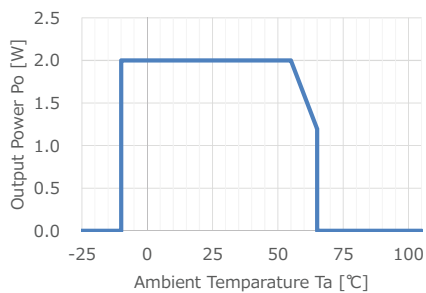

Figure 3. Temperature Derating curve

Application Circuit

$V_{IN} = 90 \sim 264 \text{ Vac}$, $V_{OUT} = 12 \text{ V}$

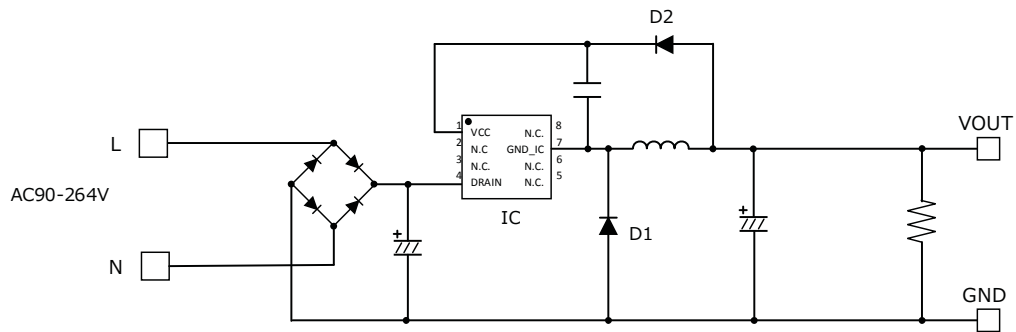

Figure 4. BM2P129TF-EVK-001 Application Circuit

The BM2P129TF is non-insulation method without opto-coupler and feeds back the VCC voltage to 12.0 V typ. This VCC voltage is the voltage between the VCC pin and the GND_IC pin.

The output voltage V_{OUT} is defined by the following equation.

$$V_{OUT} = V_{CNT} + V_{FD2} - V_{FD1}$$

V_{CNT} : VCC Control Voltage

V_{FD1} : Forward Voltage of diode D1

V_{FD2} : Forward Voltage of diode D2

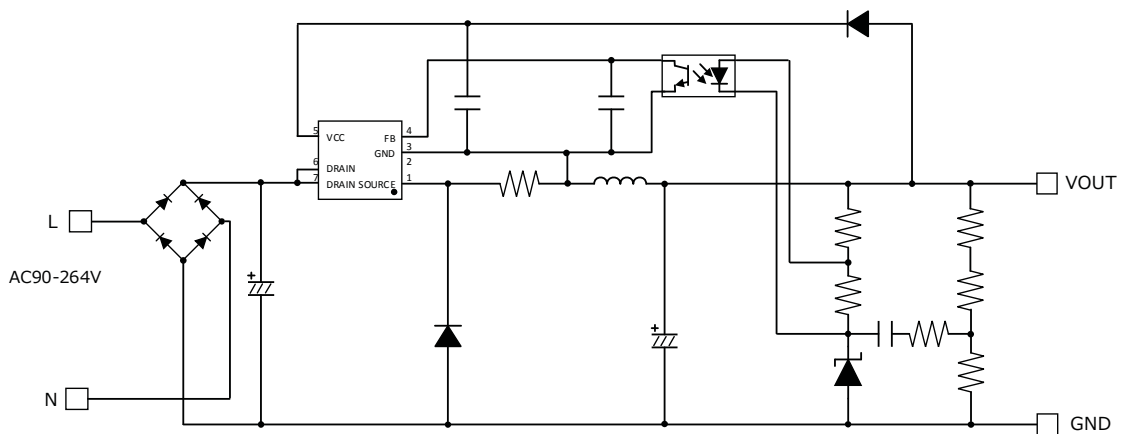

Figure 5. General Buck converter application circuit

Compared to the general Buck converter as shown above, the number of parts is reduced because the feedback circuit is not required. However, the output voltage may rise at light load because the VCC voltage and the output voltage that are fed back are different. In that case, please put a resistance on the output terminal and lower the output voltage.

BM2P129TF Overview

Feature

- PWM Frequency =100kHz
- PWM current mode method
- Frequency hopping function
- Burst operation at light load
- Built-in 650 start circuit
- Built-in 650V switching MOSFET
- VCC pin under voltage protection
- VCC pin over voltage protection
- Over current limiter function per cycle
- Soft start function

Key specifications

- Power Supply Voltage Operation Range:
 - VCC: 8.00 V to 12.98 V
 - DRAIN: to 650 V
- Normal Operation Current: 0.60 mA(Typ)
- Burst Operation Current: 0.35 mA(Typ)
- Oscillation Frequency: 100 kHz(Typ)
- Operation Temperature Range: -40 °C ~ +105 °C
- MOSFET Ron: 9.5 Ω (Typ.)

Application

LED lights, air conditioners, and cleaners, (etc.).

W(Typ) x D(Typ) x H(Typ)

SOP-J8 5.00 mm x 6.20 mm x 1.71 mm
Pitch 1.27 mm



Figure 6. SOP8 Package

(*) Product structure : Silicon monolithic integrated circuit This product has no designed protection against radioactive rays

(*) Operating the IC over the absolute maximum ratings may damage the IC. The damage can either be a short circuit between pins or an open circuit between pins and the internal circuitry. Therefore, it is important to consider circuit protection measures, such as adding a fuse, in case the IC is operated over the absolute maximum ratings.

Table 1. BM2P159T1F Pin description

No.	Name	I/O	Function	ESD Diode	
				VCC	GND
1	VCC	I	Power Supply input pin	-	✓
2	-	-	-	-	-
3	-	-	-	-	-
4	DRAIN	I/O	MOSFET DRAIN pin	-	✓
5	-	-	-	-	-
6	-	-	-	-	-
7	GND_IC	I/O	GND pin	✓	-
8	-	-	-	-	-

Design Overview

1 Important Parameter

- V_{IN} : Input Voltage Range AC 90 V ~ 264 Vac (DC 100 V ~ 380 V)
- V_{OUT} : Output Voltage DC 12 V
- $I_{OUT(Typ)}$: Constant Output Current 0.100 A
- $I_{OUT(Max)}$: Max Output Current 0.167 A
- f_{SW} : Switching Frequency Min:94 kHz, Typ:100 kHz, Max:106 kHz
- $I_{peak(Min)}$: Over Current Limit Min:0.395 A, Typ:0.450 A, Max:0.505A

2 Coil Selection

2.1 Determining coil inductance

The switching operation mode determines the L value so that it becomes as discontinuous mode (DCM) as possible. In the continuous mode (CCM), reverse current in trr of the diode flows, which leads to an increase in power loss of diode. Furthermore, this reverse current becomes the peak current when the MOSFET is ON, and the power loss of the MOSFET also increases. The constant load current $I_{OUT(Typ)}$: 0.100 A, the peak current I_L flowing through the inductor is:

$$I_P(BCM) = I_{OUT(Typ)} \times 2 = 0.2 \quad [A]$$

It tends to be in continuous mode (CCM) when the input voltage drops. Calculate with input voltage minimum voltage 100 Vdc. From the output voltage V_{OUT} : 12 V and the diode V_F : 1 V, Calculate the maximum value of Duty: Duty (Max).

$$Duty(max) = \frac{V_{OUT} + V_F}{V_{IN}(Min)}$$

From the minimum switching frequency $f_{SW}(Min) = 94$ kHz, Calculate on time $t_{on}(Max)$

$$t_{on}(Max) = \frac{Duty(Max)}{f_{SW}(Min)} = 1.38 \quad [\mu sec]$$

Calculate L value to operate in discontinuous mode.

$$L < t_{on}(Max) \times \frac{V_{IN}(Min) - V_{OUT}}{I_P} = 608.5 \quad [\mu H]$$

Then, the L value is provisionally selected to be 220 μH in consideration of generality.

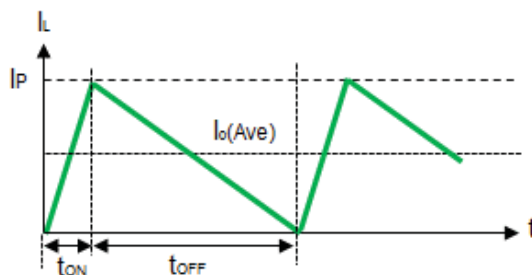

Figure 7. Coil current waveform in BCM

2.1 Determining coil inductance - Continued

Also, calculate L value so that the overcurrent detection becomes maximum load current I_{OUT}: 167 mA or more. Overcurrent detection is calculated by the current flowing through the MOSFET when operating in continuous mode at the minimum switching frequency f_{sw} (Min) = 94 kHz. When the current flowing through the MOSFET (≠ the coil current at switching ON) exceeds the minimum value I_{peak} (Min): 0.395 A of the overcurrent detection current, the MOSFET is turned OFF. Since a delay of approximately tdly = 0.1 μsec occurs, in reality, the peak current exceeds the I_{peak} value and the peak current becomes I_p. The peak current I_p is obtained by setting the current slope at switching ON to ΔI_L,

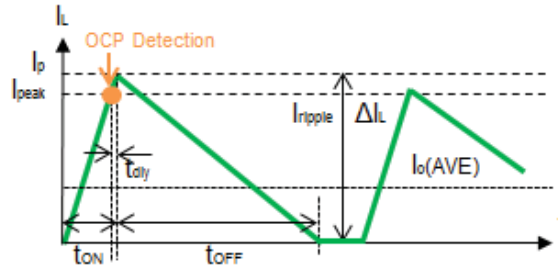

Figure 8. Coil waveform at overcurrent detection (DCM)

The peak current I_p at the time of over current detection is

$$I_p = I_{PEAK}(Min) + \Delta I_L \times tdly$$

$$I_p = I_{PEAK}(Min) + \frac{V_{IN}(Min) - V_{OUT}}{L} \times tdly = 435 \text{ [mA]}$$

Assuming the discontinuous mode (DCM), Switching ON time: t_{on}, OFF time: t_{off} are

$$t_{ON}(DCM) = \frac{I_p \times L}{V_{IN}(Min) - V_{OUT}} = 1.09 \text{ [μsec]}$$

$$t_{OFF}(DCM) = \frac{I_p \times L}{V_{OUT} + V_F} = 7.36 \text{ [μsec]}$$

$$t_{ON}(DCM) + t_{OFF}(DCM) = 8.45 \text{ [μsec]}$$

Since the total of ON time and OFF time is less than 10.64 μsec in switching cycle, it becomes discontinuous mode (DCM) when detecting over current. The current at the time of overcurrent detection in discontinuous mode (DCM): I_{OUT} (LIM) is

$$I_{OUT}(LIM) = \frac{I_p}{2} \times f_{SW} \times (t_{ON} + t_{OFF}) = 183.8 \text{ [mA]}$$

It is confirmed that the minimum over current detection current is 184 mA and the maximum load current is 167 mA or more.

2 Coil Selection - Continued

2.2 Inductor Current Calculation

Calculate the maximum peak current of the inductor. The condition where the peak current is maximized is when the input voltage is the maximum voltage $V_{IN} (Max)$: 380 V, the maximum load current $I_O (Max)$: 0.167 A, and the switching frequency is 106 kHz at the minimum. The peak current I_P of the coil is given by the following formula.

$$I_P = \sqrt{\frac{2 \times I_O \times (V_{IN}(Max) - V_O) \times (V_O + V_F)}{F_{SW}(Max) \times L \times (V_{IN} + V_F)}} = 424 \text{ [mA]}$$

Select a coil with an rated current of 0.424 A or more.

In this EVK, we use inductance value: 220 μ H, rated: 1.2 A product

Radial inductor (closed magnetic circuit type) Core Size Φ 11.0 mm x 11.5 mm

Product: 744 747 122 1

Manufacture: Würth Electronix

3 Diode Selection

3.1 Flywheel Diode: D1

Flywheel diode uses fast diode (fast recovery diode). The reverse voltage of the diode is $V_{IN} (Max)$: 380 V when the output voltage at startup is 0 V. Consider the derating and select 600 V diode. The condition where the effective current of the diode is maximized is when the input voltage is the maximum voltage $V_{IN} (Max)$: 380 V, the maximum load current $I_O (Max)$: 0.167 A, and the switching frequency is 94 kHz at the minimum.

$$Duty = \frac{V_{OUT} + V_F}{V_{IN}(Max)} = 3.4 \quad [\%]$$

The average current I_D of the diode is calculated from the peak current I_P : 0.424 A by the following formula

$$I_D(rms) = I_P \times \sqrt{\frac{1 - Duty}{3}} = 0.241 \quad [A]$$

Select the rated current of 0.241 A or more.

In fact, we used RFN1LAM6S of 0.8 A / 600 V product as a result of mounting the board and considering the parts temperature.

3.2 VCC Rectifier Diode: D2

Rectifier diodes are used for diodes to supply VCC. The reverse voltage applied to the diode is $V_{IN} (Max)$: 380 V. Consider the derating and select 600 V diode. Since the current flowing to the IC is small enough, we use the 0.2 A / 600 V RRE02VSM6S.

Design Overview – Continued

4 Capacitor Selection

4.1 Input Capacitor: C1

The input capacitor is determined by input voltage V_I and output power P_{OUT} . As a guide, for an input voltage of 90 to 264 Vac, $2 \times P_{OUT}$ [W] μ F. For 176 to 264 Vac, set $1 \times P_{OUT}$ [W] μ F. Since the output power $P_{OUT} = 2$ W, 4.7μ F / 400 V is selected with a guideline of 4.0μ F.

4.2 VCC Capacitor: C3

The VCC capacitor C3 is required for stable operation of the device and stable feedback of the output voltage. A withstand voltage of 25 V or more is required, and 1.0μ F to 4.7μ F is recommended. 1μ F / 50 V is selected.

4.3 Output Capacitor: C2, C4

For the output capacitor, select output voltage V_O of 25 V or more in consideration of derating. For C2 electrolytic capacitors, capacitance, impedance and rated ripple current must be taken into consideration.

The output ripple voltage is a composite waveform generated by electrostatic capacity: C_{OUT} , impedance: ESR when the ripple component of inductor current: ΔI_L flows into the output capacitor and is expressed by the following formula.

$$\Delta V_{ripple} = \Delta I_L \times \left(\frac{1}{8 \times C_{out} \times f_{sw}} \right) + ESR$$

The inductor ripple current is

$$\Delta I_L = 2 \times \{I_P - I_{OUT}(max)\} = 2 \times (0.424 - 0.167) = 0.514 \quad [A]$$

For this EVK, we use electrostatic capacity: 220μ F, ESR: 0.075Ω , and the design value of output ripple voltage is less than 100 mV.

$$\Delta V_{ripple} = \Delta I_L \times \left\{ \left(\frac{1}{8 \times C_{out} \times f_{sw}} \right) + ESR \right\} = 0.514 \times \left\{ \left(\frac{1}{8 \times 220 \mu \times 100k} \right) + 0.075 \right\} = 41.5 \quad [mV]$$

Next, check whether the ripple current of the capacitor satisfies the rated ripple current.

Inductor ripple current RMS conversion,

$$I_L[rms] = \Delta I_L \times \sqrt{\frac{1}{3}} = 0.297 \quad [A]$$

The ripple current of the capacitor is

$$I_C[rms] = \sqrt{I_L^2 - I_{OUT}^2} = \sqrt{0.297^2 - 0.167^2} = 0.245 \quad [A]$$

4.3 Output Capacitor C2, C4 - Continued

Select a rated current of 0.245 A or more.

The output capacitor C2 used a rated ripple current of 0.75 A at 220 μ F / 25 V.

C8 has added a 0.1 μ F ceramic capacitor to reduce switching noise.抵抗の選定

5. Resistor Selection

5.1 Bleeder Resistor: R1

Because it is indirectly fed back to the output voltage, the output voltage increases at light load. This board uses bleeder resistance for its improvement. Reducing the resistance value improves the rise in the output voltage of the light load, but increases the power loss. 10 k Ω / 0.1 W is used.

Performance Data

Constant Load Regulation

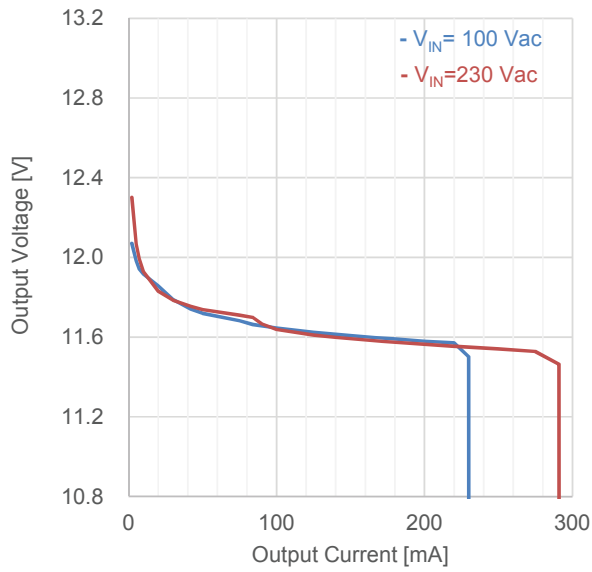

Figure 9. Load Regulation (I_{OUT} vs V_{OUT})

Table 2. Load Regulation ($V_{IN}=100$ Vac)

I_{OUT}	V_{OUT}	Efficiency
42 mA	11.741 V	74.60 %
84 mA	11.663 V	78.63 %
125 mA	11.624 V	79.84 %
167 mA	11.597 V	80.46 %

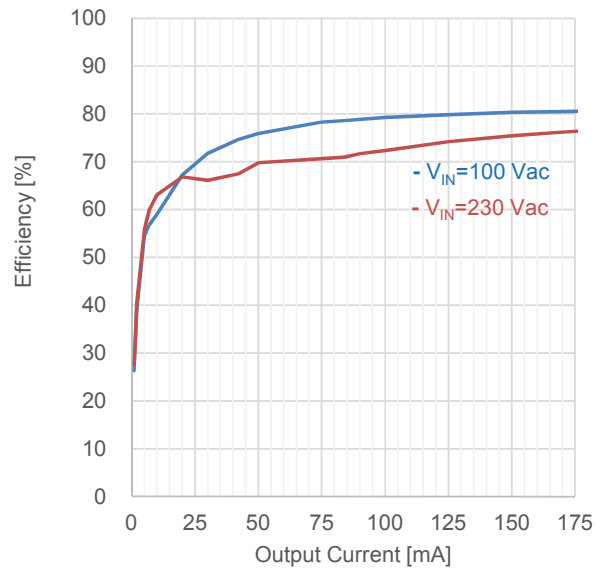

Figure 10. Load Regulation (I_{OUT} vs Efficiency)

Table 3. Load Regulation ($V_{IN}=230$ Vac)

I_{OUT}	V_{OUT}	Efficiency
42 mA	11.754 V	67.44 %
84 mA	11.699 V	70.95 %
125 mA	11.611 V	74.20 %
167 mA	11.582 V	76.09 %

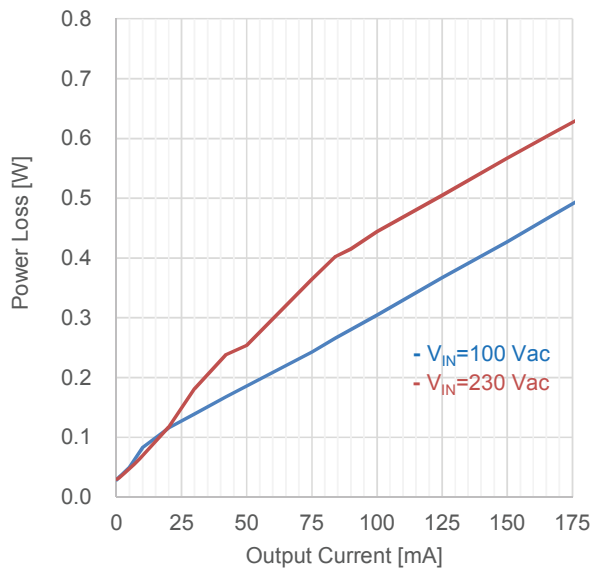

Figure 11. Load Regulation (I_{OUT} vs P_{LOSS})

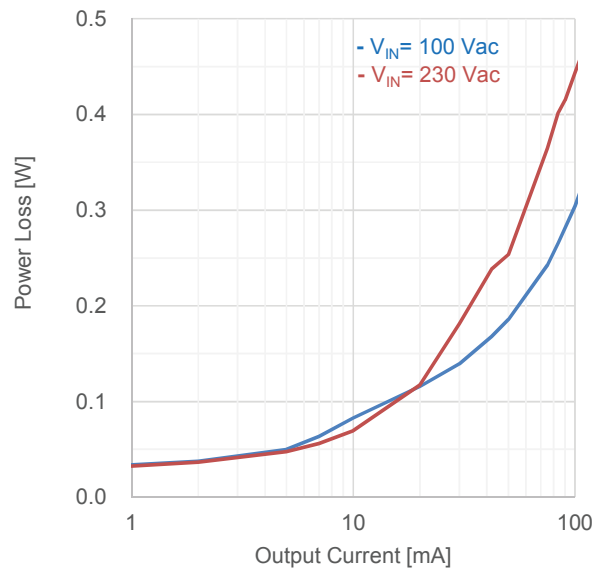

Figure 12. Load Regulation (I_{OUT} vs P_{LOSS})

Performance Data - Continued

Table 4. Load Regulation : $V_{IN}=100$ Vac

V_{IN} [Vac]	P_{IN} [W]	V_{OUT} [V]	I_{OUT} [A]	P_{OUT} [W]	P_{LOSS} [W]	Efficiency [%]
100	0.029	12.263	0	0.000	0.029	0.00
100	0.046	12.134	1	0.012	0.034	26.38
100	0.062	12.070	2	0.024	0.038	38.94
100	0.110	11.982	5	0.060	0.050	54.46
100	0.147	11.943	7	0.084	0.063	56.87
100	0.202	11.916	10	0.119	0.083	58.99
100	0.353	11.858	20	0.237	0.116	67.18
100	0.493	11.789	30	0.354	0.139	71.74
100	0.661	11.741	42	0.493	0.168	74.60
100	0.772	11.719	50	0.586	0.186	75.90
100	1.119	11.682	75	0.876	0.243	78.30
100	1.246	11.663	84	0.980	0.266	78.63
100	1.469	11.646	100	1.165	0.304	79.28
100	1.820	11.624	125	1.453	0.367	79.84
100	2.168	11.607	150	1.741	0.427	80.31
100	2.407	11.597	167	1.937	0.470	80.46
100	2.589	11.591	180	2.086	0.503	80.59
100	2.871	11.580	200	2.316	0.555	80.67
100	3.157	11.571	220	2.546	0.611	80.63
100	3.289	11.502	230	2.645	0.644	80.43
100	0.050	0.000	231	0.000	0.050	0.00

Table 5. Load Regulation: $V_{IN}=230$ Vac

V_{IN} [Vac]	P_{IN} [W]	V_{OUT} [V]	I_{OUT} [A]	P_{OUT} [W]	P_{LOSS} [W]	Efficiency [%]
230	0.030	12.850	0.0	0.000	0.030	0.00
230	0.045	12.478	1.0	0.012	0.033	27.73
230	0.061	12.301	2.0	0.025	0.036	40.33
230	0.108	12.067	5.0	0.060	0.048	55.87
230	0.140	11.994	7.0	0.084	0.056	59.97
230	0.189	11.928	10.0	0.119	0.070	63.11
230	0.354	11.831	20.0	0.237	0.117	66.84
230	0.535	11.786	30.0	0.354	0.181	66.09
230	0.732	11.754	42.0	0.494	0.238	67.44
230	0.841	11.739	50.0	0.587	0.254	69.79
230	1.243	11.711	75.0	0.878	0.365	70.66
230	1.385	11.699	84.0	0.983	0.402	70.95
230	1.465	11.667	90.0	1.050	0.415	71.67
230	1.608	11.639	100.0	1.164	0.444	72.38
230	1.956	11.611	125.0	1.451	0.505	74.20
230	2.306	11.592	150.0	1.739	0.567	75.40
230	2.542	11.582	167.0	1.934	0.608	76.09
230	2.722	11.574	180.0	2.083	0.639	76.54
230	3.000	11.564	200.0	2.313	0.687	77.09
230	3.281	11.555	220.0	2.542	0.739	77.48
230	3.767	11.542	250.0	2.886	0.882	76.60
230	4.189	11.529	275.0	3.170	1.019	75.69
230	4.450	11.463	291.0	3.336	1.114	74.96
230	0.120	0.000	292.0	0.000	0.120	0.00

Performance Data - Continued

Line Regulation

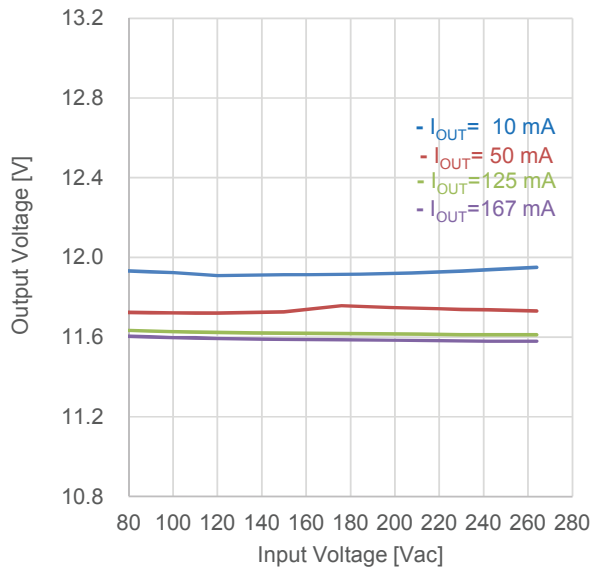

Figure 13. Line Regulation (V_{IN} vs V_{OUT})

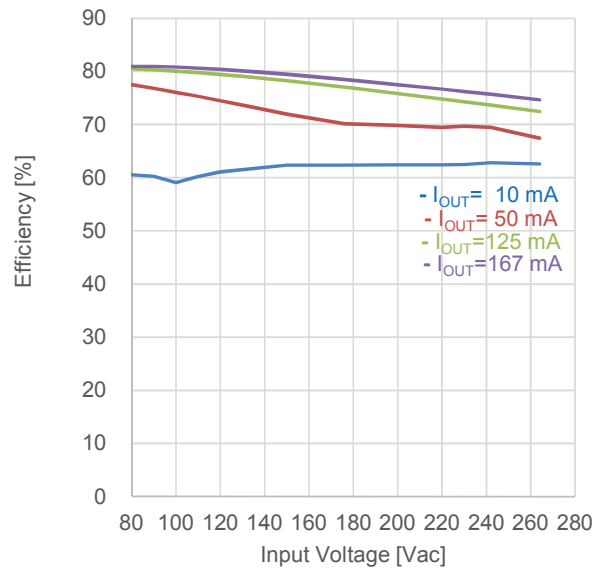

Figure 14. Line Regulation (V_{IN} vs Efficiency)

Switching Frequency

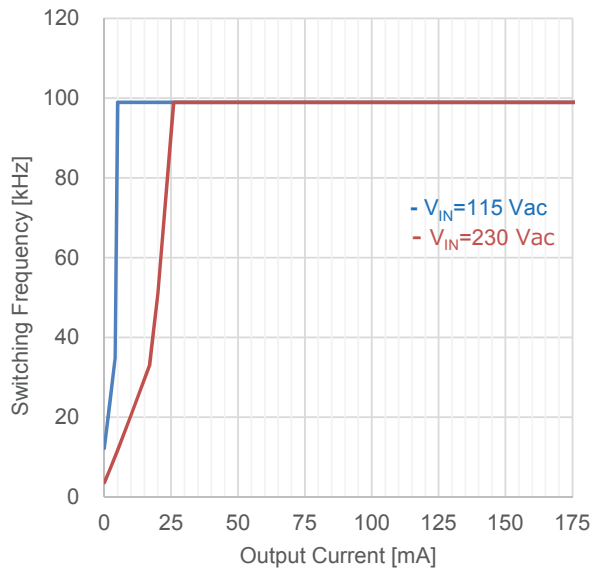

Figure 15. Switching Frequency (I_{OUT} vs f_{sw})

Coil Peak Current

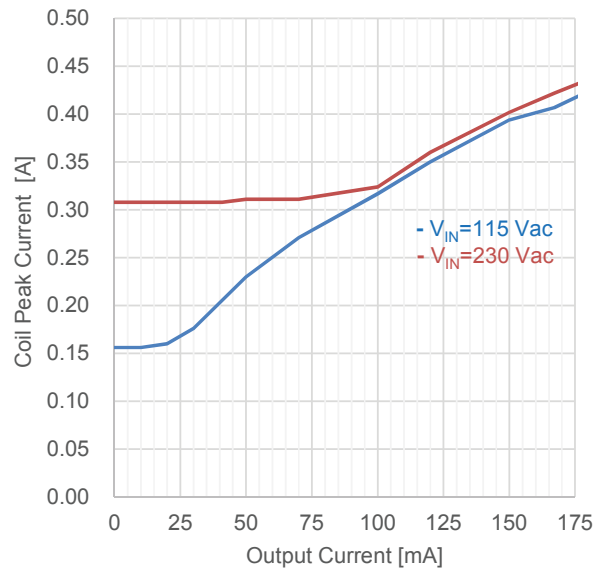

Figure 16. Coil Peak Current (I_{OUT} vs I_P)

Performance Data - Continued

Output Ripple Voltage

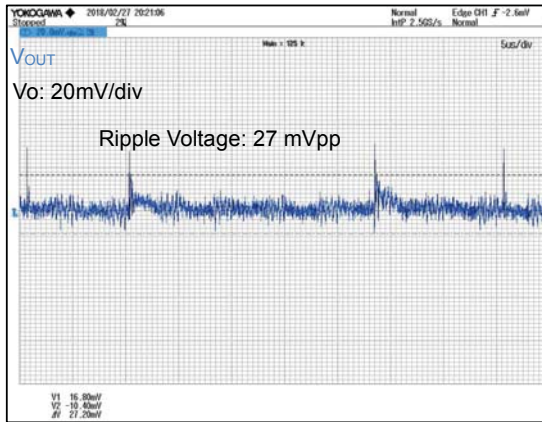

Figure 17. $V_{IN} = 115 \text{ Vac}$, $I_{OUT} = 10 \text{ mA}$

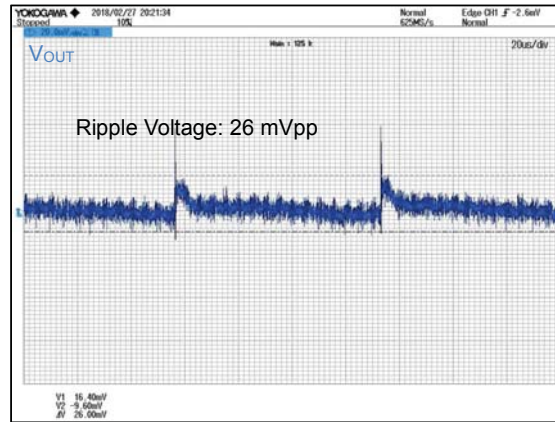

Figure 18. $V_{IN} = 230 \text{ Vac}$, $I_{OUT} = 10 \text{ mA}$

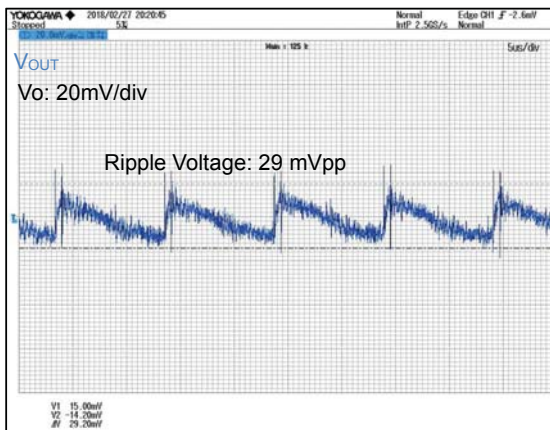

Figure 19. $V_{IN} = 115 \text{ Vac}$, $I_{OUT} = 0.100 \text{ A}$

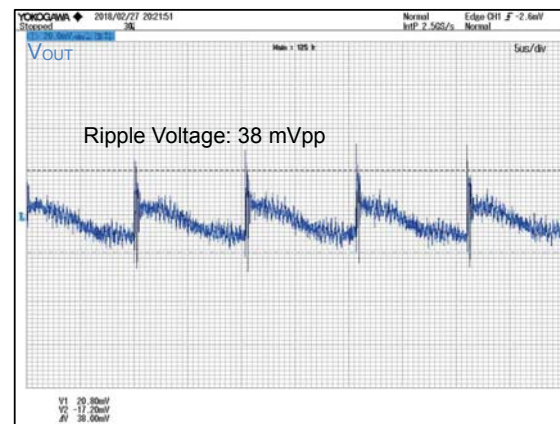

Figure 20. $V_{IN} = 230 \text{ Vac}$, $I_{OUT} = 0.100 \text{ A}$

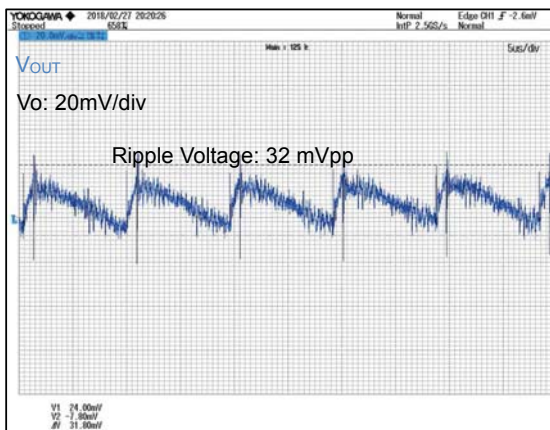

Figure 21. $V_{IN} = 115 \text{ Vac}$, $I_{OUT} = 0.167 \text{ A}$

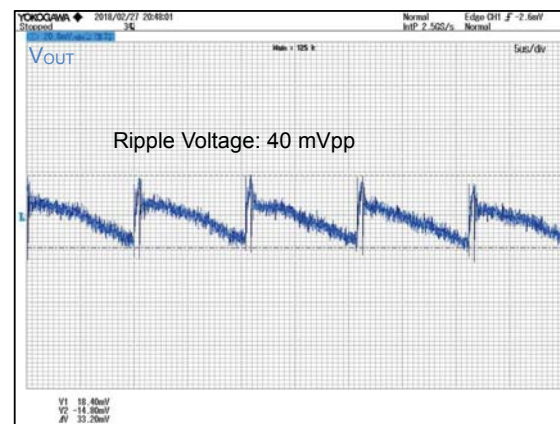

Figure 22. $V_{IN} = 230 \text{ Vac}$, $I_{OUT} = 0.167 \text{ A}$

Performance Data – Continued

Parts surface temperature

Table 6. Parts surface temperature ※Ta = 25 °C, measured 30 minutes after setup

Part	Condition			
	V _{IN} =90 Vac, I _{OUT} =0.100 A	V _{IN} =90 Vac, I _{OUT} =0.167 A	V _{IN} =264 Vac, I _{OUT} =0.100 A	V _{IN} =264 Vac, I _{OUT} =0.167 A
IC1	43.8 °C	48.1 °C	64.4 °C	67.6 °C
D1	45.6 °C	51.3 °C	52.1 °C	57.6 °C
L1	41.9 °C	42.7 °C	48.3 °C	51.3 °C

Schematics

V_{IN} = 90 ~ 264 Vac, V_{OUT} = 12 V

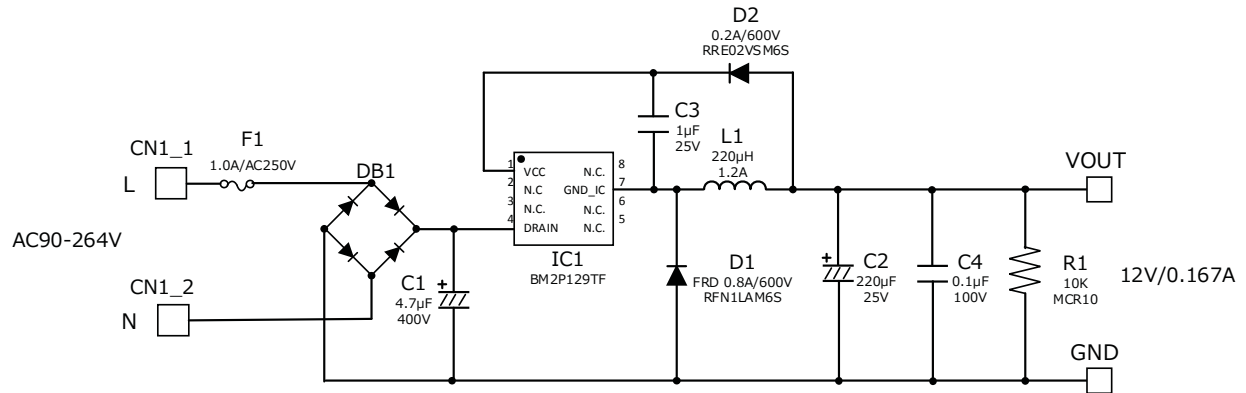

Figure 23. BM2P129TF-EVK-001 Schematics

Bill of Materials

Table 7. BoM of BM2P129TF-EVK-001

Part Reference	Qty.	Type	Value	Description	Part Number	Manufacture	Configuration mm (inch)
C1	1	Electrolytic	4.7 µF	400 V, ±20%	860 021 374 008	Würth	-
C2	1	Electrolytic	220 µF	25 V, ±20%	860 080 474 010	Würth	-
C3	1	Ceramic	1 µF	25 V, X7R, ±20%	TMK107B7105MA-T	Taiyo Yuden	1608 (0603)
C4	1	Ceramic	0.1 µF	100 V, X7R, ±20%	HMK107B7104MA-T	Taiyo Yuden	1608 (0603)
CN1	1	Connector	-	2pin	B2P-VH	JST	-
D1	1	FRD	0.8 A	600 V	RFN1LAM6S	ROHM	PMDS
D2	1	Diode	0.2 A	600 V	RRE02VSM6S	ROHM	TUMD2SM
DB1	1	Bridge	1 A	800 V	D1UBA80-7062	Shindengen	SOPA-4
F1	1	Fuse	1 A	250 V	39211000000	Littelfuse	-
IC1	1	AC/DC Converter	-	-	BM2P129TF	ROHM	SOP8
L1	1	Coil	220 µH	1.2 A	744 747 122 1	Würth	-
R1	1	Resistor	10k Ω	0.1 W, ±5%	MCR10EZPJ103	ROHM	2012 (0805)

Layout

Size: 18 mm x 40 mm

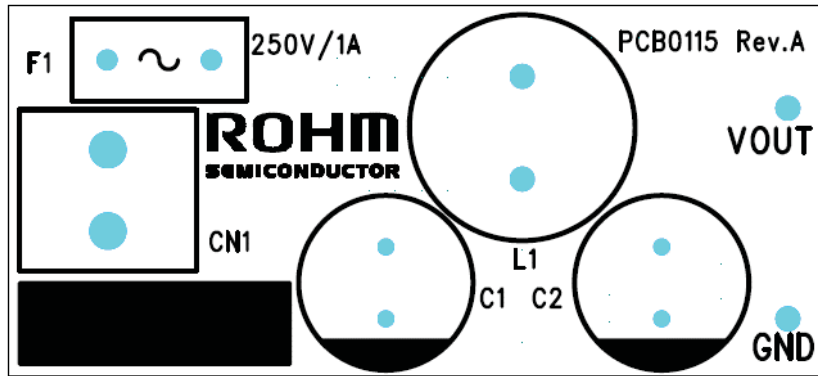

Figure 24. TOP Silkscreen (Top view)

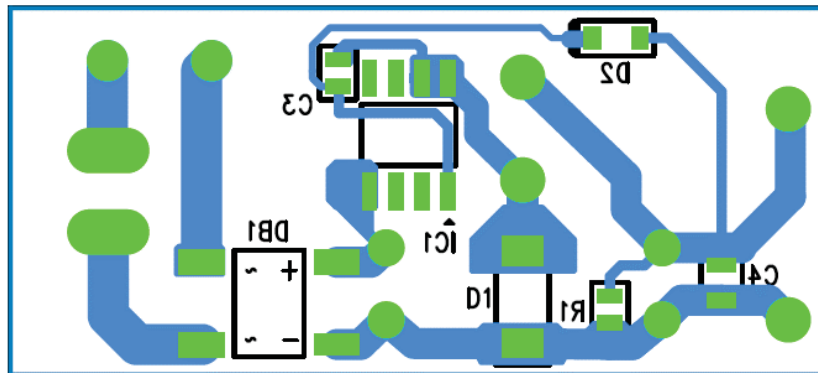

Figure 25. Bottom Layout (TOP View)

Notes

- 1) The information contained herein is subject to change without notice.
- 2) Before you use our Products, please contact our sales representative and verify the latest specifications :
- 3) Although ROHM is continuously working to improve product reliability and quality, semiconductors can break down and malfunction due to various factors.
Therefore, in order to prevent personal injury or fire arising from failure, please take safety measures such as complying with the derating characteristics, implementing redundant and fire prevention designs, and utilizing backups and fail-safe procedures. ROHM shall have no responsibility for any damages arising out of the use of our Products beyond the rating specified by ROHM.
- 4) Examples of application circuits, circuit constants and any other information contained herein are provided only to illustrate the standard usage and operations of the Products. The peripheral conditions must be taken into account when designing circuits for mass production.
- 5) The technical information specified herein is intended only to show the typical functions of and examples of application circuits for the Products. ROHM does not grant you, explicitly or implicitly, any license to use or exercise intellectual property or other rights held by ROHM or any other parties. ROHM shall have no responsibility whatsoever for any dispute arising out of the use of such technical information.
- 6) The Products specified in this document are not designed to be radiation tolerant.
- 7) For use of our Products in applications requiring a high degree of reliability (as exemplified below), please contact and consult with a ROHM representative : transportation equipment (i.e. cars, ships, trains), primary communication equipment, traffic lights, fire/crime prevention, safety equipment, medical systems, servers, solar cells, and power transmission systems.
- 8) Do not use our Products in applications requiring extremely high reliability, such as aerospace equipment, nuclear power control systems, and submarine repeaters.
- 9) ROHM shall have no responsibility for any damages or injury arising from non-compliance with the recommended usage conditions and specifications contained herein.
- 10) ROHM has used reasonable care to ensure the accuracy of the information contained in this document. However, ROHM does not warrants that such information is error-free, and ROHM shall have no responsibility for any damages arising from any inaccuracy or misprint of such information.
- 11) Please use the Products in accordance with any applicable environmental laws and regulations, such as the RoHS Directive. For more details, including RoHS compatibility, please contact a ROHM sales office. ROHM shall have no responsibility for any damages or losses resulting non-compliance with any applicable laws or regulations.
- 12) When providing our Products and technologies contained in this document to other countries, you must abide by the procedures and provisions stipulated in all applicable export laws and regulations, including without limitation the US Export Administration Regulations and the Foreign Exchange and Foreign Trade Act.
- 13) This document, in part or in whole, may not be reprinted or reproduced without prior consent of ROHM.



Thank you for your accessing to ROHM product informations.
More detail product informations and catalogs are available, please contact us.

ROHM Customer Support System

<http://www.rohm.com/contact/>

Mouser Electronics

Authorized Distributor

Click to View Pricing, Inventory, Delivery & Lifecycle Information:

[ROHM Semiconductor:](#)

[BM2P129TF-EVK-001](#)

Компания «Океан Электроники» предлагает заключение долгосрочных отношений при поставках импортных электронных компонентов на взаимовыгодных условиях!

Наши преимущества:

- Поставка оригинальных импортных электронных компонентов напрямую с производств Америки, Европы и Азии, а так же с крупнейших складов мира;
- Широкая линейка поставок активных и пассивных импортных электронных компонентов (более 30 млн. наименований);
- Поставка сложных, дефицитных, либо снятых с производства позиций;
- Оперативные сроки поставки под заказ (от 5 рабочих дней);
- Экспресс доставка в любую точку России;
- Помощь Конструкторского Отдела и консультации квалифицированных инженеров;
- Техническая поддержка проекта, помощь в подборе аналогов, поставка прототипов;
- Поставка электронных компонентов под контролем ВП;
- Система менеджмента качества сертифицирована по Международному стандарту ISO 9001;
- При необходимости вся продукция военного и аэрокосмического назначения проходит испытания и сертификацию в лаборатории (по согласованию с заказчиком);
- Поставка специализированных компонентов военного и аэрокосмического уровня качества (Xilinx, Altera, Analog Devices, Intersil, Interpoint, Microsemi, Actel, Aeroflex, Peregrine, VPT, Syfer, Eurofarad, Texas Instruments, MS Kennedy, Miteq, Cobham, E2V, MA-COM, Hittite, Mini-Circuits, General Dynamics и др.);

Компания «Океан Электроники» является официальным дистрибьютором и эксклюзивным представителем в России одного из крупнейших производителей разъемов военного и аэрокосмического назначения «JONHON», а так же официальным дистрибьютором и эксклюзивным представителем в России производителя высокотехнологичных и надежных решений для передачи СВЧ сигналов «FORSTAR».



JONHON

«JONHON» (основан в 1970 г.)

Разъемы специального, военного и аэрокосмического назначения:

(Применяются в военной, авиационной, аэрокосмической, морской, железнодорожной, горно- и нефтедобывающей отраслях промышленности)

«FORSTAR» (основан в 1998 г.)

ВЧ соединители, коаксиальные кабели, кабельные сборки и микроволновые компоненты:

(Применяются в телекоммуникациях гражданского и специального назначения, в средствах связи, РЛС, а так же военной, авиационной и аэрокосмической отраслях промышленности).



Телефон: 8 (812) 309-75-97 (многоканальный)

Факс: 8 (812) 320-03-32

Электронная почта: ocean@oceanchips.ru

Web: <http://oceanchips.ru/>

Адрес: 198099, г. Санкт-Петербург, ул. Калинина, д. 2, корп. 4, лит. А