

## STELLA-RS

~25° spot beam. Compatible with up to 30 mm LES size COBs. Variant with black frame.

### TECHNICAL SPECIFICATIONS:

Dimensions	Ø 90.0 mm
Height	39.2 mm
Fastening	screw
ROHS compliant	yes ⓘ

### MATERIAL SPECIFICATIONS:

Component	Type	Material	Colour	Finish
STELLA-RS	Single lens	Silicone	clear	
STELLA-FRAME	Holder	PA66	black	





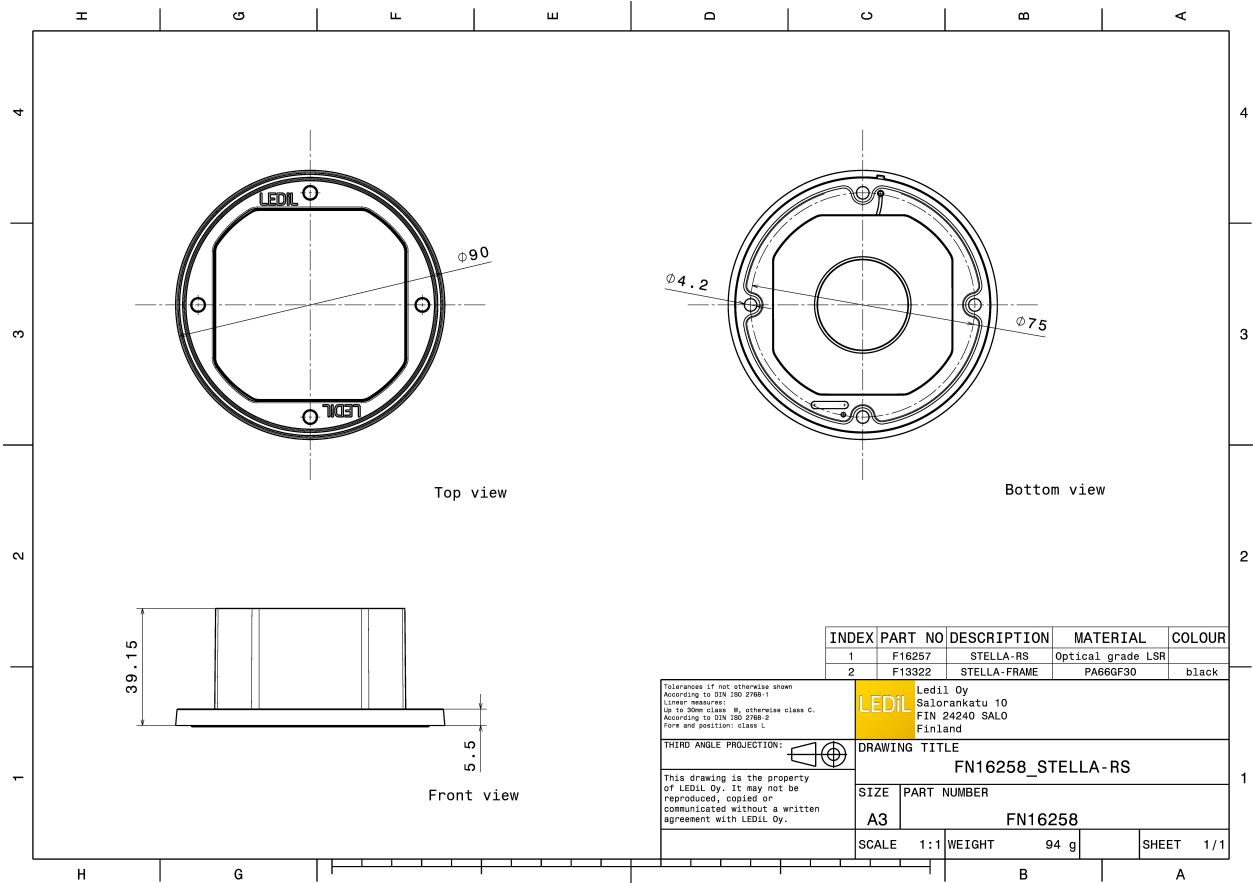

### ORDERING INFORMATION:



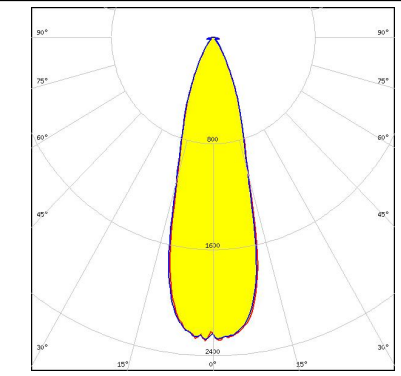
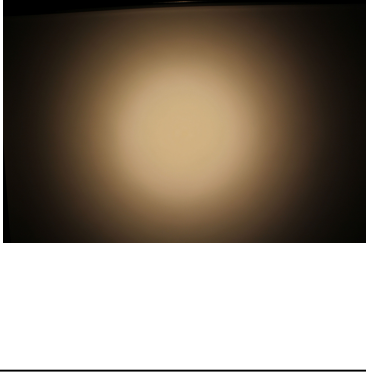
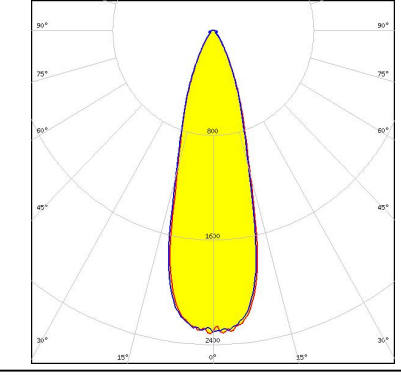

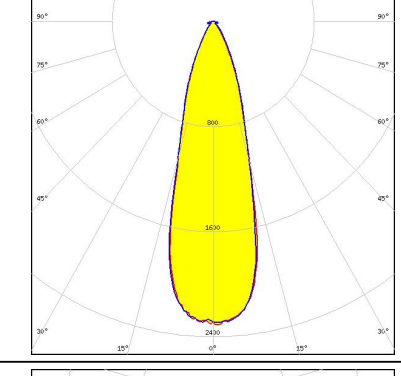
Component		Qty in box	MOQ	MPQ	Box weight (kg)
FN16258_STELLA-RS	Single lens	90	90	15	9.8
» Box size: 480 x 280 x 300 mm					

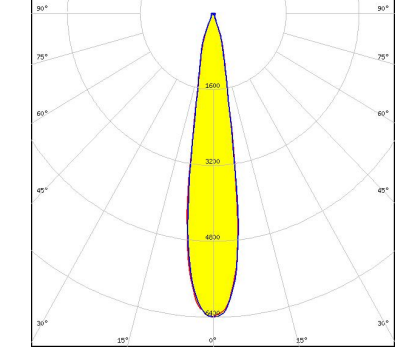

#### PHOTOMETRIC DATA (MEASURED):

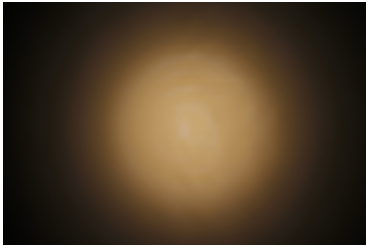
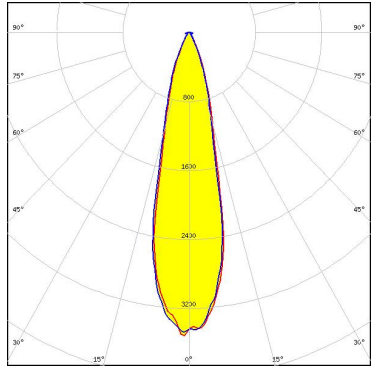
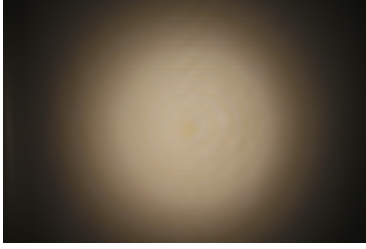
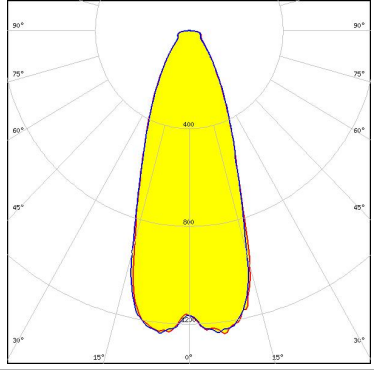
<p>bridgelux.</p> <p>LED V22 Gen7</p> <p>FWHM 29.0°</p> <p>Efficiency 94 %</p> <p>Peak intensity 2.3 cd/lm</p> <p>LEDs/each optic 1</p> <p>Light colour White</p> <p>Required components:</p>		
<p>bridgelux.</p> <p>LED V22 Gen7</p> <p>FWHM 29.0°</p> <p>Efficiency 94 %</p> <p>Peak intensity 2.3 cd/lm</p> <p>LEDs/each optic 1</p> <p>Light colour White</p> <p>Required components: TE: 2213480-1</p>		
<p>bridgelux.</p> <p>LED V22 Gen7</p> <p>FWHM 29.0°</p> <p>Efficiency 94 %</p> <p>Peak intensity 2.3 cd/lm</p> <p>LEDs/each optic 1</p> <p>Light colour White</p> <p>Required components: Bender Wirth: 431 Typ Z1</p>		
<p>bridgelux.</p> <p>LED VERO13</p> <p>FWHM 18.0°</p> <p>Efficiency 94 %</p> <p>Peak intensity 6.4 cd/lm</p> <p>LEDs/each optic 1</p> <p>Light colour White</p> <p>Required components:</p>		

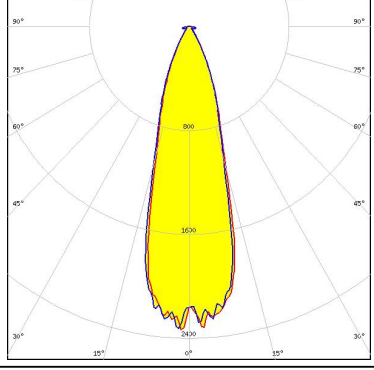
#### PHOTOMETRIC DATA (MEASURED):

<p><b>bridgelux</b></p> <p>LED VERO18            FWHM 24.0°            Efficiency 94 %            Peak intensity 3.5 cd/lm            LEDs/each optic 1            Light colour White            Required components:</p>		
<p><b>bridgelux</b></p> <p>LED VERO29            FWHM 39.0°            Efficiency 94 %            Peak intensity 1.3 cd/lm            LEDs/each optic 1            Light colour White            Required components:</p>		
<p><b>CITIZEN</b></p> <p>LED CLL04x/CLU04x            FWHM 29.0°            Efficiency 94 %            Peak intensity 2.4 cd/lm            LEDs/each optic 1            Light colour White            Required components:</p>		
<p><b>CREE</b></p> <p>LED CXA/B 1816 &amp; CXA/B 1820 &amp; CXA 1850            FWHM 18.0°            Efficiency 94 %            Peak intensity 6.5 cd/lm            LEDs/each optic 1            Light colour White            Required components:</p>		

#### PHOTOMETRIC DATA (MEASURED):



LED CXA/B 30xx  
 FWHM 31.0°  
 Efficiency 94 %  
 Peak intensity 2.3 cd/lm  
 LEDs/each optic 1  
 Light colour White  
 Required components:

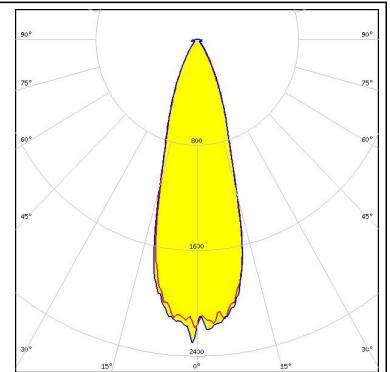

LED LUXEON CoB 1211  
 FWHM 26.0°  
 Efficiency 94 %  
 Peak intensity 3 cd/lm  
 LEDs/each optic 1  
 Light colour White  
 Required components:  
 Bender Wirth: 431 Typ L3

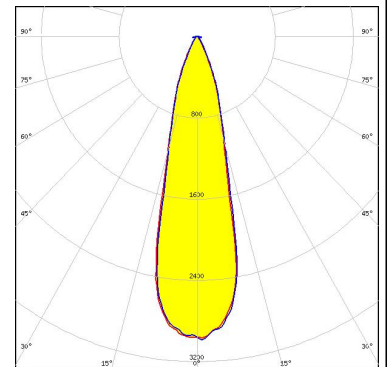
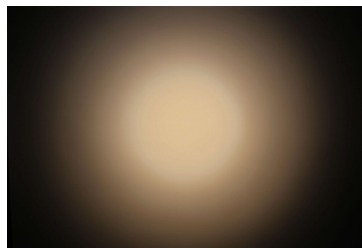

LED COB H-Type  
 FWHM 30.0°  
 Efficiency 94 %  
 Peak intensity 2.2 cd/lm  
 LEDs/each optic 1  
 Light colour White  
 Required components:

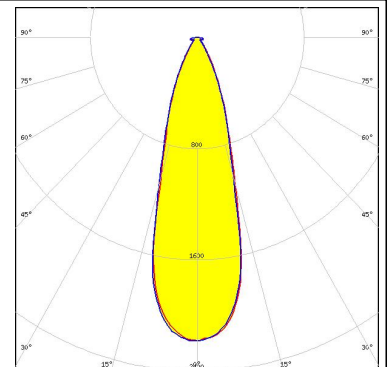
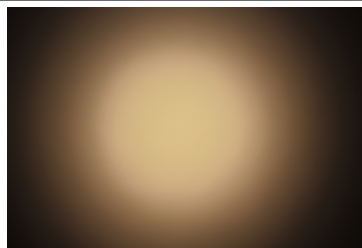

LED COB J-Type  
 FWHM 20.0°  
 Efficiency 94 %  
 Peak intensity 5 cd/lm  
 LEDs/each optic 1  
 Light colour White  
 Required components:

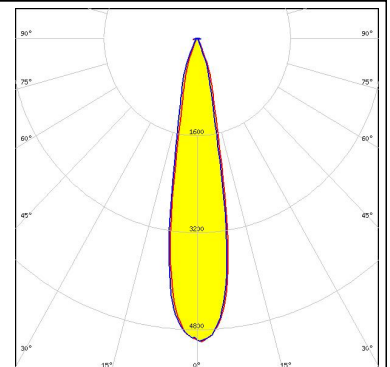

### PHOTOMETRIC DATA (MEASURED):

#### SAMSUNG

LED LC040D / LC060D / LC080D  
FWHM 29.0°  
Efficiency 93 %  
Peak intensity 2.2 cd/lm  
LEDs/each optic 1  
Light colour White  
Required components:

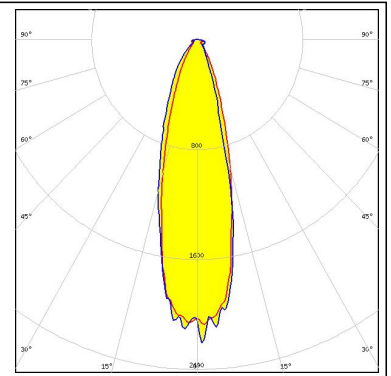
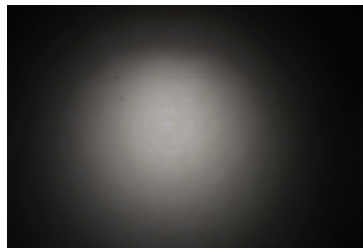



#### PHOTOMETRIC DATA (SIMULATED):

bridgelux.

LED	V10 Gen7
FWHM	14.0°
Efficiency	96 %
Peak intensity	9.9 cd/lm
LEDs/each optic	1
Light colour	White
Required components:	
	Bender Wirth: 486 Typ L1

bridgelux.

LED	VERO10
FWHM	13.0°
Efficiency	94 %
Peak intensity	11.9 cd/lm
LEDs/each optic	1
Light colour	White
Required components:	

### CITIZEN

LED	CLL03x/CLU03x
FWHM	18.0°
Efficiency	95 %
Peak intensity	5.8 cd/lm
LEDs/each optic	1
Light colour	White
Required components:	

### CITIZEN

LED	CLL05x/CLU05x
FWHM	43.0°
Efficiency	94 %
Peak intensity	1 cd/lm
LEDs/each optic	1
Light colour	White
Required components:	

#### PHOTOMETRIC DATA (SIMULATED):



LED CMA2550  
 FWHM 27.0°  
 Efficiency 94 %  
 Peak intensity 3.2 cd/lm  
 LEDs/each optic 1  
 Light colour White  
 Required components:

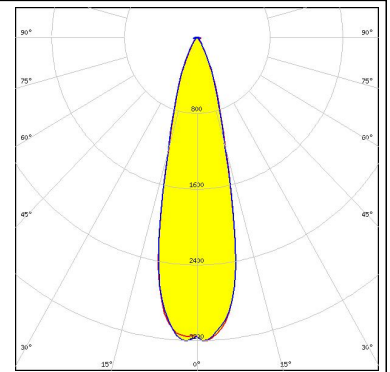

LED CMA3090  
 FWHM 30.0°  
 Efficiency 94 %  
 Peak intensity 2.4 cd/lm  
 LEDs/each optic 1  
 Light colour White  
 Required components:

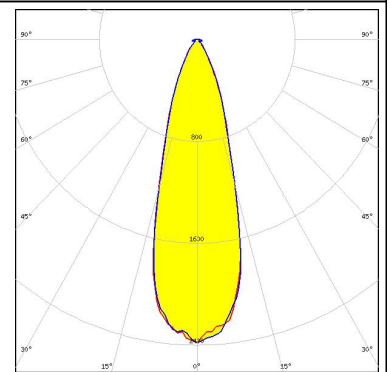

LED CMT19xx  
 FWHM 20.0°  
 Efficiency 95 %  
 Peak intensity 5 cd/lm  
 LEDs/each optic 1  
 Light colour White  
 Required components:



LED CMT28xx  
 FWHM 30.0°  
 Efficiency 95 %  
 Peak intensity 2.4 cd/lm  
 LEDs/each optic 1  
 Light colour White  
 Required components:



### PHOTOMETRIC DATA (SIMULATED):



LED CXA/B 25xx  
 FWHM 25.0°  
 Efficiency 94 %  
 Peak intensity 3.4 cd/lm  
 LEDs/each optic 1  
 Light colour White  
 Required components:

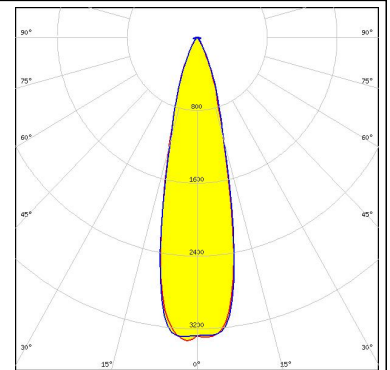

LED LUXEON CoB 1216/1812  
 FWHM 31.0°  
 Efficiency 94 %  
 Peak intensity 2.1 cd/lm  
 LEDs/each optic 1  
 Light colour White  
 Required components:

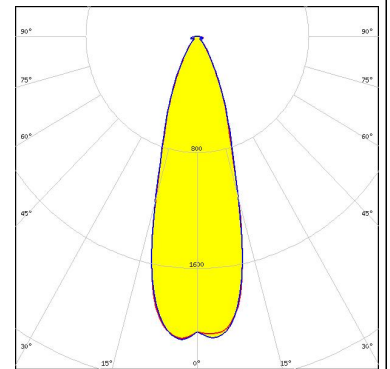

LED LUXEON CoB 1321  
 FWHM 41.0°  
 Efficiency 94 %  
 Peak intensity 1.2 cd/lm  
 LEDs/each optic 1  
 Light colour White  
 Required components:

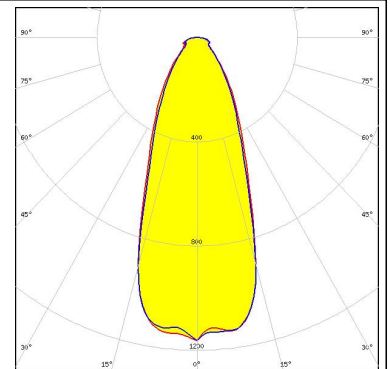

LED LUXEON CoB 1825  
 FWHM 44.1°  
 Efficiency 94 %  
 Peak intensity 0.9 cd/lm  
 LEDs/each optic 1  
 Light colour White  
 Required components:

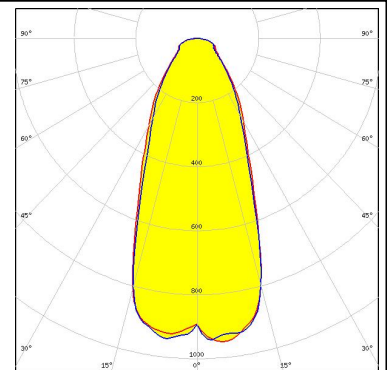

### GENERAL INFORMATION:

NOTE: The typical beam angle will be changed by different color, chip size and chip position tolerance. The typical total beam angle is the full angle measured where the luminous intensity is half of the peak value.

Due to use of high power COB's with this product, special attention to proper thermal design is highly recommended. LEDiL has no liability for direct, indirect or consecutive damages arising from the LEDiL products being used outside of the recommended temperature range.

### MATERIALS:

As part of our continuous research and improvement processes, and to ensure the best possible quality and availability of our products, LEDiL reserves the right to change material grades without notice.

### PRODUCT DATA USER AGREEMENT AND DISCLAIMER:

The measured data in the provided downloadable LEDiL Product Datasheets and Mechanical 2D-Drawings is rounded and provided as reference for planning. LEDiL Oy's optical specifications have been verified by conducting performance testing of the products in accordance with the company's quality system. The reported data are averaged results of multiple measurements with typical variation. LEDiL Oy reserves the right to without prior notification make changes and improvements to its products.

LEDiL Oy assumes neither warranty, nor guarantee nor any other liability of any kind for the contents and correctness of the provided data. The provided data has been generated with highest diligence but the provided data may in reality not represent the complete possible variation range of all intrinsic parameters. Therefore, in certain cases a deviation from the provided data could occur.

LEDiL Oy reserves the right to undertake technical changes of its products without further notification which could lead to changes in the provided data. LEDiL Oy assumes no liability of any kind for the possible deviation from any provided data or any other damage resulting from the usage of the provided data.

The user agrees to this disclaimer and user agreement with the download or usage of the provided files.

#### LEDiL Oy

Joensuunkatu 13  
FI-24240 SALO  
Finland

#### LEDiL Inc.

228 West Page Street  
Suite D  
Sycamore IL 60178  
USA

#### Local sales and technical support

[www.ledil.com/  
where\\_to\\_buy](http://www.ledil.com/where_to_buy)

#### Shipping locations

Salo, Finland  
Hong Kong, China

#### Distribution Partners

[www.ledil.com/  
where\\_to\\_buy](http://www.ledil.com/where_to_buy)

Компания «Океан Электроники» предлагает заключение долгосрочных отношений при поставках импортных электронных компонентов на взаимовыгодных условиях!

Наши преимущества:

- Поставка оригинальных импортных электронных компонентов напрямую с производств Америки, Европы и Азии, а так же с крупнейших складов мира;
- Широкая линейка поставок активных и пассивных импортных электронных компонентов (более 30 млн. наименований);
- Поставка сложных, дефицитных, либо снятых с производства позиций;
- Оперативные сроки поставки под заказ (от 5 рабочих дней);
- Экспресс доставка в любую точку России;
- Помощь Конструкторского Отдела и консультации квалифицированных инженеров;
- Техническая поддержка проекта, помощь в подборе аналогов, поставка прототипов;
- Поставка электронных компонентов под контролем ВП;
- Система менеджмента качества сертифицирована по Международному стандарту ISO 9001;
- При необходимости вся продукция военного и аэрокосмического назначения проходит испытания и сертификацию в лаборатории (по согласованию с заказчиком);
- Поставка специализированных компонентов военного и аэрокосмического уровня качества (Xilinx, Altera, Analog Devices, Intersil, Interpoint, Microsemi, Actel, Aeroflex, Peregrine, VPT, Syfer, Eurofarad, Texas Instruments, MS Kennedy, Miteq, Cobham, E2V, MA-COM, Hittite, Mini-Circuits, General Dynamics и др.);

Компания «Океан Электроники» является официальным дистрибьютором и эксклюзивным представителем в России одного из крупнейших производителей разъемов военного и аэрокосмического назначения «JONHON», а так же официальным дистрибьютором и эксклюзивным представителем в России производителя высокотехнологичных и надежных решений для передачи СВЧ сигналов «FORSTAR».



## JONHON

«JONHON» (основан в 1970 г.)

Разъемы специального, военного и аэрокосмического назначения:

(Применяются в военной, авиационной, аэрокосмической, морской, железнодорожной, горно- и нефтедобывающей отраслях промышленности)

«FORSTAR» (основан в 1998 г.)

ВЧ соединители, коаксиальные кабели,  
кабельные сборки и микроволновые компоненты:

(Применяются в телекоммуникациях гражданского и специального назначения, в средствах связи, РЛС, а так же военной, авиационной и аэрокосмической отраслях промышленности).



Телефон: 8 (812) 309-75-97 (многоканальный)

Факс: 8 (812) 320-03-32

Электронная почта: [ocean@oceanchips.ru](mailto:ocean@oceanchips.ru)

Web: <http://oceanchips.ru/>

Адрес: 198099, г. Санкт-Петербург, ул. Калинина, д. 2, корп. 4, лит. А