

# Type DCMC 85 °C High Capacitance, Screw Terminal, Aluminum

## Highest Capacitance Screw Terminal Type



With more capacitance and often more ripple-current capability than the best-value Type 3186 capacitor, the Type DCMC capacitor is the better choice for high-capacitance, power supply filters and energy storage applications such as welding equipment, UPS systems and computer hold-up power. The extended cathode foil of the DCMC assures cool operation with heatflow from the capacitor element to the can.

### Highlights

- Highest capacitance value
- Right for Power Supply and UPS systems
- Thermal-Pak™ extended cathode construction

### Specifications

Temperature Range	-40 °C to +85 °C							
Rated Voltage Range	6.3 Vdc to 550 Vdc							
Capacitance Range	110 µF to 2.7 F							
Capacitance Tolerance	-10% +75% ≤ 100 Vdc -10% +50% ≥ 160 Vdc							
Leakage Current	≤ 6 $\sqrt{CV}$ µA, 6 mA max, at 5 min							
Ripple Current Multipliers	Ambient Temperature							
		45 °C	55 °C	65 °C	75 °C	85 °C		
		2.24	2.00	1.73	1.41	1.00		
		Frequency						
		50 Hz	60 Hz	120 Hz	360 Hz	1 kHz	5 kHz	10 kHz & up
	<b>1 3/8" &amp; 1 3/4" Diameters</b>							
	<b>6.3 to 160 V</b>	0.92	0.94	1.00	1.05	1.10	1.10	1.12
	<b>200 to 350 V</b>	0.80	0.85	1.00	1.17	1.30	1.30	1.32
	<b>400 to 550 V</b>	0.78	0.83	1.00	1.20	1.35	1.36	1.40
	<b>2" &amp; 2 1/2" Diameters</b>							
<b>6.3 to 160 V</b>	0.93	0.95	1.00	1.04	1.07	1.11	1.12	
<b>200 to 350 V</b>	0.81	0.87	1.00	1.13	1.20	1.24	1.26	
<b>400 to 550 V</b>	0.79	0.83	1.00	1.17	1.26	1.30	1.34	
<b>3" &amp; 3 1/2" Diameters</b>								
<b>6.3 to 160 V</b>	0.95	0.96	1.00	1.02	1.04	1.05	1.05	
<b>200 to 350 V</b>	0.85	0.88	1.00	1.08	1.12	1.14	1.17	
<b>400 to 550 V</b>	0.82	0.84	1.00	1.13	1.20	1.24	1.27	
Low Temperature Characteristics	Impedance ratio: $Z_{-20^{\circ}\text{C}}/Z_{+25^{\circ}\text{C}}$ ≤ 20 (6.3–10 Vdc) ≤ 8 (16–50 Vdc) ≤ 4 (63–100 Vdc) ≤ 3 (150–550 Vdc)							
Endurance Life Test	2000 h @ full load at 85 °C Δ Capacitance ±20% ESR 200% of limit DCL 100% of limit							
Shelf Life Test	500 h @ 85 °C Capacitance 100% of limit ESR 100% of limit DCL 100% of limit							
Vibration	5 to 55 Hz, 0.06" and 10 g max, 1.5 h each of 2 axes							
RoHS Compliant								

# Type DCMC 85 °C High Capacitance, Screw Terminal, Aluminum

## Highest Capacitance Screw Terminal Type

### Part Numbering System

<b>DCMC</b>	<b>472</b>	<b>U</b>	<b>400</b>	<b>DC</b>	<b>2</b>	<b>B</b>	<b>S</b>
<b>Type</b>	<b>Capacitance</b>	<b>Tolerance</b>	<b>Voltage</b>	<b>Case Code</b>	<b>Insulation</b>	<b>Terminal</b>	<b>Can Style</b>
<b>100</b> = 10 $\mu$ F	<b>101</b> = 100 $\mu$ F	<b>M</b> = $\pm 20\%$	<b>6R3</b> = 6.3 Vdc	<b>0</b> = None	<b>0</b> = None	<b>A</b> = Low Post	<b>Blank</b> =
<b>492</b> = 4900 $\mu$ F	<b>433</b> = 43,000 $\mu$ F	<b>U</b> = -10%+75%	<b>063</b> = 63 Vdc	<b>1</b> = Polyester	<b>1</b> = Polyester	<b>B</b> = High Post	Standard
		<b>T</b> = -10%+50%	<b>400</b> = 400 Vdc	<b>2</b> = PVC	<b>2</b> = PVC	<b>D</b> = High Current, Low Post	<b>S</b> = Stud
						<b>E</b> = High Current, High Post	Bottom
						<b>F or M</b> = M5 Post	<b>P</b> = Stud
						<b>G</b> = M6 Low Post	with
						<b>H</b> = M6 High Post	Thermal
							Pad

Polyester insulation is not available for 3.5-inch diameter units.  
Standard insulation is 0.008-in PVC sleeve with 0.01-in polypropylene end disk.

### Outline Drawing

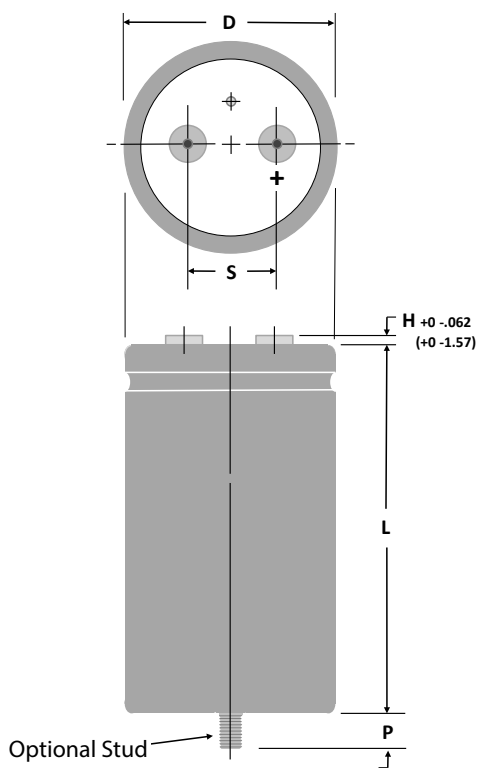

NOTE: With the stud-mount feature, a thermally-conductive disk can be inserted in the bottom flush with the outer insulating sleeve. This reduces the thermal resistance through the can bottom by 0.3 °C/W. Can Style P.

### Stud Dimensions

Case Diam.	Stud Thread	P ± 0.039" (±1.0 mm)
1.375	M8	0.470" (12.0)
1.750	M8	0.470" (12.0)
2.000	M12	0.630" (16.0)
2.500	M12	0.630" (16.0)
3.000	M12	0.630" (16.0)
3.500	M12	0.630" (16.0)

### Terminal Dimensions

Terminal Style	For Case Diameters	Code	Post Diameter		H max		Thread	min Full Thread		Torque	
			in	mm	in	mm		in	mm	in-lb	N-m
<b>Low Post</b>	1 3/8 to 3	A	0.314	8.0	0.094	2.4	10-32	0.218	5.5	25	2.82
<b>High Post</b>	1 3/8 to 3	B	0.314	8.0	0.281	7.1	10-32	0.375	9.5	25	2.82
<b>High Current, Low</b>	2 1/2 to 3 1/2	D	0.684	17.4	0.125	3.2	1/4-28	0.344	8.7	60	6.78
<b>High Current, High</b>	2 1/2 to 3 1/2	E	0.684	17.4	0.281	7.1	1/4-28	0.469	11.9	60	6.78
<b>M5 Post, Small</b>	1 3/8 to 2	M	0.314	8.0	0.281	7.1	M5	0.375	9.5	25	2.82
<b>M5 Post</b>	2 1/2 & 3	F	0.512	13.0	0.230	5.8	M5	0.344	8.7	25	2.82
<b>M6 Low Post</b>	2 1/2 to 3 1/2	G	0.684	17.4	0.125	3.2	M6	0.344	8.7	60	6.78
<b>M6 High Post</b>	2 1/2 to 3 1/2	H	0.684	17.4	0.281	7.1	M6	0.469	11.9	60	6.78

NOTE: Only high post and M5 post terminals are available at 550 Vdc as they meet the required creepage distance.

# Type DCMC 85 °C High Capacitance, Screw Terminal, Aluminum

## Highest Capacitance Screw Terminal Type

### Uninsulated Case Dimensions

For insulated case, add 0.024"(0.610 mm) to "D" and 0.030"(0.762 mm) to height.

Case Code	Diam. (D)		Length (L)		Terminals (S)		Typical Weight	
	±.031 Inches	±.78 mm	±.062 Inches	±1.57 mm	±0.015 Inches	±.38 mm	oz	g
AK	1.375	34.93	1.625	41.28	0.50	12.70	1.9	54
AA	1.375	34.93	2.125	53.98	0.50	12.70	2.0	57
AH	1.375	34.93	2.625	66.68	0.50	12.70	2.7	77
AB	1.375	34.93	3.125	79.38	0.50	12.70	3.3	94
AJ	1.375	34.93	3.625	92.08	0.50	12.70	3.8	108
AC	1.375	34.93	4.125	104.78	0.50	12.70	4.4	125
AD	1.375	34.93	4.625	117.48	0.50	12.70	5.1	145
AE	1.375	34.93	5.125	130.18	0.50	12.70	6.8	193
AF	1.375	34.93	5.625	142.88	0.50	12.70	8.1	230
EA	1.750	44.45	2.125	53.98	0.75	19.05	2.7	76
EH	1.750	44.45	2.625	66.68	0.75	19.05	3.8	108
EB	1.750	44.45	3.125	79.38	0.75	19.05	5.1	145
EJ	1.750	44.45	3.625	92.08	0.75	19.05	6.8	193
EC	1.750	44.45	4.125	104.78	0.75	19.05	8.1	230
ED	1.750	44.45	4.625	117.48	0.75	19.05	9.0	255
EE	1.750	44.45	5.125	130.18	0.75	19.05	9.5	269
EF	1.750	44.45	5.625	142.88	0.75	19.05	10.5	298
BA	2.000	50.80	2.125	53.98	0.88	22.23	5.4	153
BH	2.000	50.80	2.625	66.68	0.88	22.23	6.1	173
BB	2.000	50.80	3.125	79.38	0.88	22.23	6.8	193
BJ	2.000	50.80	3.625	92.08	0.88	22.23	8.2	232
BC	2.000	50.80	4.125	104.78	0.88	22.23	9.5	269
BD	2.000	50.80	4.625	117.48	0.88	22.23	10.3	292
BE	2.000	50.80	5.125	130.18	0.88	22.23	10.7	303
BF	2.000	50.80	5.625	142.88	0.88	22.23	13.0	369
CH	2.500	63.50	2.625	66.68	1.13	28.58	9.2	261
CB	2.500	63.50	3.125	79.38	1.13	28.58	10.4	295
CJ	2.500	63.50	3.625	92.08	1.13	28.58	12.7	361
CC	2.500	63.50	4.125	104.78	1.13	28.58	15.0	425
CD	2.500	63.50	4.625	117.48	1.13	28.58	17.2	488
CE	2.500	63.50	5.125	130.18	1.13	28.58	19.3	547
CF	2.500	63.50	5.625	142.88	1.13	28.58	21.4	607
DB	3.000	76.20	3.125	79.38	1.25	31.75	16.7	473
DJ	3.000	76.20	3.625	92.08	1.25	31.75	20.0	567
DC	3.000	76.20	4.125	104.78	1.25	31.75	22.2	629
DD	3.000	76.20	4.625	117.48	1.25	31.75	25.5	723
DE	3.000	76.20	5.125	130.18	1.25	31.75	30.0	850
DF	3.000	76.20	5.625	142.88	1.25	31.75	31.9	904
DM	3.000	76.20	6.625	168.28	1.25	31.75	34.4	933.5
DP	3.000	76.20	5.875	149.23	1.25	31.75	32.8	931
DN	3.000	76.20	7.625	193.68	1.25	31.75	39.5	1119
DG	3.000	76.20	8.625	219.08	1.25	31.75	43.3	1227
FC	3.500	88.90	4.125	104.78	1.25	31.75	30.0	850
FD	3.500	88.90	4.625	117.48	1.25	31.75	34.4	976
FE	3.500	88.90	5.125	130.18	1.25	31.75	40.5	1148
FF	3.500	88.90	5.625	142.88	1.25	31.75	43.1	1221
FP	3.500	88.90	5.875	149.23	1.25	31.75	44.3	1257
FN	3.500	88.90	7.625	193.68	1.25	31.75	53.3	1512
FG	3.500	88.90	8.625	219.08	1.25	31.75	58.5	1658
FM	3.500	88.90	6.625	168.28	1.25	31.75	46.4	1315.4

# Type DCMC 85 °C High Capacitance, Screw Terminal, Aluminum

## Highest Capacitance Screw Terminal Type Ratings

Cap. (µF)	Catalog Part Number	ESR Max. @ 25 °C 120 Hz (mΩ)	Ripple Max. @ 85°C 120 Hz (A)	Nominal Size D x L (inches)
<b>6.3 Vdc (8 Vdc Surge)</b>				
28000	DCMC283U6R3AK2B	46.9	4.1	1 3/8 x 1 5/8
57000	DCMC573U6R3AA2B	26.5	6.1	1 3/8 x 2 1/8
68000	DCMC683U6R3AH2B	18.8	7.8	1 3/8 x 2 5/8
91000	DCMC913U6R3AB2B	14.7	9.4	1 3/8 x 3 1/8
100000	DCMC104U6R3EA2B	18.8	8.8	1 3/4 x 2 1/8
110000	DCMC114U6R3AJ2B	12.8	11.2	1 3/8 x 3 5/8
120000	DCMC124U6R3EH2B	14.3	11.0	1 3/4 x 2 5/8
130000	DCMC134U6R3AC2B	11.0	13.0	1 3/8 x 4 1/8
130000	DCMC134U6R3BA2B	14.2	11.9	2 x 2 1/8
150000	DCMC154U6R3BH2B	9.9	11.6	2 x 2 5/8
160000	DCMC164U6R3AD2B	9.8	12.5	1 3/8 x 4 5/8
160000	DCMC164U6R3EB2B	11.0	12.6	1 3/4 x 3 1/8
180000	DCMC184U6R3AE2B	8.9	14.7	1 3/8 x 5 1/8
200000	DCMC204U6R3AF2B	8.3	16.0	1 3/8 x 5 5/8
200000	DCMC204U6R3EJ2B	9.1	15.9	1 3/4 x 3 5/8
210000	DCMC214U6R3BB2B	7.8	17.8	2 x 3 1/8
240000	DCMC244U6R3EC2B	7.9	18.3	1 3/4 x 4 1/8
260000	DCMC264U6R3BJ2B	6.5	15.6	2 x 3 5/8
260000	DCMC264U6R3CH2B	6.9	16.2	2 1/2 x 2 5/8
280000	DCMC284U6R3ED2B	7.0	17.1	1 3/4 x 4 5/8
310000	DCMC314U6R3BC2B	5.6	20.2	2 x 4 1/8
320000	DCMC324U6R3EE2B	6.4	19.7	1 3/4 x 5 1/8
350000	DCMC354U6R3CB2B	5.3	22.6	2 1/2 x 3 1/8
360000	DCMC364U6R3EF2B	6.0	22.0	1 3/4 x 5 5/8
370000	DCMC374U6R3BD2B	5.0	24.9	2 x 4 5/8
420000	DCMC424U6R3BE2B	4.5	23.0	2 x 5 1/8
440000	DCMC444U6R3CJ2B	4.3	25.0	2 1/2 x 3 5/8
470000	DCMC474U6R3BF2B	4.2	26.7	2 x 5 5/8
520000	DCMC524U6R3DB2B	4.1	28.3	3 x 3 1/8
530000	DCMC534U6R3CC2D	3.8	30.4	2 1/2 x 4 1/8
610000	DCMC614U6R3CD2D	3.4	33.4	2 1/2 x 4 5/8
650000	DCMC654U6R3DJ2D	3.3	34.6	3 x 3 5/8
700000	DCMC704U6R3CE2D	3.1	33.3	2 1/2 x 5 1/8
780000	DCMC784U6R3DC2D	2.9	35.7	3 x 4 1/8
790000	DCMC794U6R3CF2D	2.8	37.9	2 1/2 x 5 5/8
910000	DCMC914U6R3DD2D	2.6	41.0	3 x 4 5/8
1000000	DCMC105U6R3DE2D	2.4	44.4	3 x 5 1/8
1100000	DCMC115U6R3DF2D	2.4	45.0	3 x 5 5/8
1100000	DCMC115U6R3FC2D	3.0	41.4	3 1/2 x 4 1/8
1200000	DCMC125U6R3DP2D	2.4	51.5	3 x 5 7/8
1200000	DCMC125U6R3FD2D	2.6	43.2	3 1/2 x 4 5/8
1400000	DCMC145U6R3FE2D	2.4	47.1	3 1/2 x 5 1/8
1600000	DCMC165U6R3DN2D	2.4	49.3	3 x 7 5/8
1600000	DCMC165U6R3FF2D	2.4	47.9	3 1/2 x 5 5/8
1700000	DCMC175U6R3FP2D	2.4	49.4	3 1/2 x 5 7/8
1900000	DCMC195U6R3DG2D	2.4	49.9	3 x 8 5/8
2300000	DCMC235U6R3FN2D	2.4	54.1	3 1/2 x 7 5/8

Cap. (µF)	Catalog Part Number	ESR Max. @ 25 °C 120 Hz (mΩ)	Ripple Max. @ 85°C 120 Hz (A)	Nominal Size D x L (inches)
2700000	DCMC275U6R3FG2D	2.4	56.5	3 1/2 x 8 5/8
<b>10 Vdc (12 Vdc Surge)</b>				
24000	DCMC243U010AK2B	46.9	4.1	1 3/8 x 1 5/8
44000	DCMC443U010AA2B	26.5	6.1	1 3/8 x 2 1/8
57000	DCMC573U010AH2B	20.1	7.5	1 3/8 x 2 5/8
76000	DCMC763U010AB2B	15.5	9.2	1 3/8 x 3 1/8
79000	DCMC793U010EA2B	18.8	8.8	1 3/4 x 2 1/8
96000	DCMC963U010AJ2B	12.8	11.2	1 3/8 x 3 5/8
100000	DCMC104U010EH2B	14.3	11.0	1 3/4 x 2 5/8
100000	DCMC104U010BA2B	17.6	10.3	2 x 2 1/8
110000	DCMC114U010AC2B	11.0	13.5	1 3/8 x 4 1/8
130000	DCMC134U010AD2B	9.8	11.6	1 3/8 x 4 5/8
140000	DCMC144U010EB2B	11.0	11.8	1 3/4 x 3 1/8
140000	DCMC144U010BH2B	13.4	11.4	2 x 2 5/8
150000	DCMC154U010AE2B	8.9	14.7	1 3/8 x 5 1/8
170000	DCMC174U010AF2B	8.3	16.0	1 3/8 x 5 5/8
170000	DCMC174U010EJ2B	9.1	15.9	1 3/4 x 3 5/8
180000	DCMC184U010BB2B	10.5	15.4	2 x 3 1/8
210000	DCMC214U010EC2B	7.9	18.3	1 3/4 x 4 1/8
220000	DCMC224U010BJ2B	8.7	13.5	2 x 3 5/8
220000	DCMC224U010CH2B	8.8	14.4	2 1/2 x 2 5/8
240000	DCMC244U010ED2B	7.0	17.1	1 3/4 x 4 5/8
270000	DCMC274U010BC2B	7.5	17.4	2 x 4 1/8
280000	DCMC284U010EE2B	6.4	19.7	1 3/4 x 5 1/8
290000	DCMC294U010CB2B	6.7	20.0	2 1/2 x 3 1/8
310000	DCMC314U010EF2B	6.0	22.0	1 3/4 x 5 5/8
310000	DCMC314U010BD2B	6.7	21.5	2 x 4 5/8
350000	DCMC354U010BE2B	6.1	19.8	2 x 5 1/8
370000	DCMC374U010CJ2B	5.5	22.1	2 1/2 x 3 5/8
400000	DCMC404U010BF2B	5.7	22.9	2 x 5 5/8
430000	DCMC434U010DB2B	4.1	28.3	3 x 3 1/8
440000	DCMC444U010CC2B	4.8	26.9	2 1/2 x 4 1/8
510000	DCMC514U010CD2B	4.3	29.5	2 1/2 x 4 5/8
540000	DCMC544U010DJ2D	3.3	34.6	3 x 3 5/8
590000	DCMC594U010CE2B	3.9	29.5	2 1/2 x 5 1/8
640000	DCMC644U010DC2D	2.9	35.7	3 x 4 1/8
660000	DCMC664U010CF2D	3.6	33.5	2 1/2 x 5 5/8
750000	DCMC754U010DD2D	2.6	41.0	3 x 4 5/8
860000	DCMC864U010DE2D	2.4	44.4	3 x 5 1/8
900000	DCMC904U010FC2D	2.9	41.6	3 1/2 x 4 1/8
940000	DCMC944U010DF2D	2.3	47.1	3 x 5 5/8
1000000	DCMC105U010DP2D	2.3	52.8	3 x 5 7/8
1000000	DCMC105U010FD2D	2.8	42.0	3 1/2 x 4 5/8
1200000	DCMC125U010FE2D	2.5	46.3	3 1/2 x 5 1/8
1300000	DCMC135U010FF2D	2.2	50.3	3 1/2 x 5 5/8
1400000	DCMC145U010DN2D	2.1	52.7	3 x 7 5/8
1400000	DCMC145U010FP2D	2.1	52.7	3 1/2 x 5 7/8
1600000	DCMC165U010DG2D	2.1	54.2	3 x 8 5/8

# Type DCMC 85 °C High Capacitance, Screw Terminal, Aluminum

## Highest Capacitance Screw Terminal Type

Cap. ( $\mu$ F)	Catalog Part Number	ESR Max. @ 25 °C 120 Hz (m $\Omega$ )	Ripple Max. @ 85°C 120 Hz (A)	Nominal Size D x L (inches)
1900000	DCMC195U010FN2D	1.8	64.3	3 1/2 x 7 5/8
2200000	DCMC225U010FG2D	1.5	70.6	3 1/2 x 8 5/8
<b>16 Vdc (20 Vdc Surge)</b>				
21000	DCMC213U016AK2B	46.9	4.1	1 3/8 x 1 5/8
35000	DCMC353U016AA2B	26.5	6.1	1 3/8 x 2 1/8
49000	DCMC493U016AH2B	20.1	7.5	1 3/8 x 2 5/8
57000	DCMC573U016EA2B	18.8	8.3	1 3/4 x 2 1/8
62000	DCMC623U016AB2B	15.5	9.7	1 3/8 x 3 1/8
73000	DCMC733U016BA2B	17.6	9.5	2 x 2 1/8
76000	DCMC763U016AJ2B	12.8	11.7	1 3/8 x 3 5/8
77000	DCMC773U016EH2B	15.3	11.1	1 3/4 x 2 5/8
90000	DCMC903U016AC2B	11.0	13.5	1 3/8 x 4 1/8
99000	DCMC993U016AD2B	9.8	11.6	1 3/8 x 4 5/8
100000	DCMC104U016EB2B	12.5	11.1	1 3/4 x 3 1/8
110000	DCMC114U016AE2B	8.9	14.0	1 3/8 x 5 1/8
110000	DCMC114U016BH2B	13.4	12.0	2 x 2 5/8
130000	DCMC134U016AF2B	8.3	16.0	1 3/8 x 5 5/8
130000	DCMC134U016EJ2B	10.9	14.6	1 3/4 x 3 5/8
130000	DCMC134U016BB2B	10.5	15.4	2 x 3 1/8
150000	DCMC154U016EC2B	9.7	16.5	1 3/4 x 4 1/8
160000	DCMC164U016BJ2B	8.7	13.5	2 x 3 5/8
160000	DCMC164U016CH2B	8.8	14.4	2 1/2 x 2 5/8
180000	DCMC184U016ED2B	8.8	15.3	1 3/4 x 4 5/8
200000	DCMC204U016BC2B	7.5	17.4	2 x 4 1/8
210000	DCMC214U016EE2B	8.2	17.5	1 3/4 x 5 1/8
220000	DCMC224U016CB2B	6.7	20.0	2 1/2 x 3 1/8
230000	DCMC234U016EF2B	7.8	19.3	1 3/4 x 5 5/8
230000	DCMC234U016BD2B	6.7	21.5	2 x 4 5/8
260000	DCMC264U016BE2B	6.1	19.8	2 x 5 1/8
270000	DCMC274U016CJ2B	5.5	22.1	2 1/2 x 3 5/8
290000	DCMC294U016BF2B	5.7	22.9	2 x 5 5/8
320000	DCMC324U016CC2B	5.0	25.6	2 1/2 x 4 1/8
320000	DCMC324U016DB2B	4.2	28.9	3 x 3 1/8
380000	DCMC384U016CD2B	4.6	28.5	2 1/2 x 4 5/8
400000	DCMC404U016DJ2D	3.6	33.3	3 x 3 5/8
430000	DCMC434U016CE2B	4.4	27.9	2 1/2 x 5 1/8
480000	DCMC484U016DC2D	3.3	33.8	3 x 4 1/8
490000	DCMC494U016CF2D	4.2	31.2	2 1/2 x 5 5/8
560000	DCMC564U016DD2D	3.1	37.5	3 x 4 5/8
650000	DCMC654U016DE2D	2.8	40.5	3 x 5 1/8
700000	DCMC704U016FC2D	2.9	41.6	3 1/2 x 4 1/8
710000	DCMC714U016DF2D	2.8	42.8	3 x 5 5/8
750000	DCMC754U016DP2D	2.8	48.3	3 x 5 7/8
810000	DCMC814U016FD2D	2.8	42.1	3 1/2 x 4 5/8
930000	DCMC934U016FE2D	2.5	46.2	3 1/2 x 5 1/8
1000000	DCMC105U016FF2D	2.4	48.3	3 1/2 x 5 5/8
1000000	DCMC105U016DN2D	2.6	47.5	3 x 7 5/8
1500000	DCMC155U016FN2D	2.3	55.4	3 1/2 x 7 5/8

Cap. ( $\mu$ F)	Catalog Part Number	ESR Max. @ 25 °C 120 Hz (m $\Omega$ )	Ripple Max. @ 85°C 120 Hz (A)	Nominal Size D x L (inches)
1700000	DCMC175U016FG2D	2.3	58.2	3 1/2 x 8 5/8
<b>25 Vdc (30 Vdc Surge)</b>				
12000	DCMC123U025AK2B	37.1	4.7	1 3/8 x 1 5/8
20000	DCMC203U025AA2B	23.6	6.5	1 3/8 x 2 1/8
24000	DCMC243U025AH2B	20.1	7.5	1 3/8 x 2 5/8
33000	DCMC333U025AB2B	19.3	8.2	1 3/8 x 3 1/8
36000	DCMC363U025EA2B	21.8	8.2	1 3/4 x 2 1/8
42000	DCMC423U025AJ2B	19.4	9.1	1 3/8 x 3 5/8
43000	DCMC433U025EH2B	19.4	9.5	1 3/4 x 2 5/8
47000	DCMC473U025BA2B	21.8	9.3	2 x 2 1/8
52000	DCMC523U025AC2B	17.6	10.7	1 3/8 x 4 1/8
59000	DCMC593U025BH2B	16.5	9.0	2 x 2 5/8
60000	DCMC603U025EB2B	15.2	10.1	1 3/4 x 3 1/8
61000	DCMC613U025AD2B	16.4	10.3	1 3/8 x 4 5/8
71000	DCMC713U025AE2B	15.2	11.3	1 3/8 x 5 1/8
76000	DCMC763U025BB2B	12.2	13.2	2 x 3 1/8
77000	DCMC773U025EJ2B	12.8	13.4	1 3/4 x 3 5/8
80000	DCMC803U025AF2B	14.0	13.3	1 3/8 x 5 5/8
90000	DCMC903U025CH2B	9.5	16.7	2 1/2 x 2 5/8
94000	DCMC943U025EC2B	11.2	11.8	1 3/4 x 4 1/8
98000	DCMC983U025BJ2B	9.8	13.6	2 x 3 5/8
110000	DCMC114U025ED2B	10.2	14.2	1 3/4 x 4 5/8
120000	DCMC124U025BC2B	8.3	16.6	2 x 4 1/8
130000	DCMC134U025EE2B	9.6	16.1	1 3/4 x 5 1/8
130000	DCMC134U025CB2B	7.6	18.9	2 1/2 x 3 1/8
140000	DCMC144U025BD2B	7.3	19.9	2 x 4 5/8
150000	DCMC154U025EF2B	9.1	18.4	1 3/4 x 5 5/8
160000	DCMC164U025BE2B	6.6	19.1	2 x 5 1/8
160000	DCMC164U025CJ2B	6.4	20.5	2 1/2 x 3 5/8
190000	DCMC194U025BF2B	6.1	22.2	2 x 5 5/8
190000	DCMC194U025DB2B	5.0	25.5	3 x 3 1/8
200000	DCMC204U025CC2B	5.8	24.6	2 1/2 x 4 1/8
230000	DCMC234U025CD2B	5.2	26.8	2 1/2 x 4 5/8
240000	DCMC244U025DJ2D	4.3	30.5	3 x 3 5/8
270000	DCMC274U025CE2B	5.0	26.0	2 1/2 x 5 1/8
300000	DCMC304U025DC2D	3.9	31.0	3 x 4 1/8
310000	DCMC314U025CF2B	4.6	29.8	2 1/2 x 5 5/8
350000	DCMC354U025DD2D	3.5	35.1	3 x 4 5/8
400000	DCMC404U025DE2D	3.3	37.5	3 x 5 1/8
430000	DCMC434U025FC2D	3.8	36.0	3 1/2 x 4 1/8
460000	DCMC464U025DF2D	3.2	39.9	3 x 5 5/8
490000	DCMC494U025DP2D	3.1	46.0	3 x 5 7/8
500000	DCMC504U025FD2D	3.5	37.6	3 1/2 x 4 5/8
580000	DCMC584U025FE2D	3.2	40.3	3 1/2 x 5 1/8
660000	DCMC664U025FF2D	3.1	42.8	3 1/2 x 5 5/8
670000	DCMC674U025DN2D	3.1	44.0	3 x 7 5/8
700000	DCMC704U025FP2D	2.9	44.9	3 1/2 x 5 7/8
780000	DCMC784U025DG2D	3.0	44.9	3 x 8 5/8

# Type DCMC 85 °C High Capacitance, Screw Terminal, Aluminum

## Highest Capacitance Screw Terminal Type

Cap. (µF)	Catalog Part Number	ESR Max. @ 25 °C 120 Hz (mΩ)	Ripple Max. @ 85°C 120 Hz (A)	Nominal Size D x L (inches)
950000	DCMC954U025FN2D	3.0	48.7	3 1/2 x 7 5/8
1100000	DCMC115U025FG2D	2.9	51.1	3 1/2 x 8 5/8
<b>35 Vdc (40 Vdc Surge)</b>				
8200	DCMC822U035AK2B	41.7	4.4	1 3/8 x 1 5/8
14000	DCMC143U035AA2B	26.7	6.1	1 3/8 x 2 1/8
16000	DCMC163U035AH2B	23.2	7.0	1 3/8 x 2 5/8
23000	DCMC233U035AB2B	21.9	7.7	1 3/8 x 3 1/8
25000	DCMC253U035EA2B	22.3	8.1	1 3/4 x 2 1/8
30000	DCMC303U035AJ2B	21.6	8.6	1 3/8 x 3 5/8
30000	DCMC303U035EH2B	19.2	9.5	1 3/4 x 2 5/8
32000	DCMC323U035BA2B	24.5	8.8	2 x 2 1/8
36000	DCMC363U035AC2B	20.1	10.0	1 3/8 x 4 1/8
41000	DCMC413U035BH2B	20.1	8.1	2 x 2 5/8
42000	DCMC423U035EB2B	15.5	10.0	1 3/4 x 3 1/8
43000	DCMC433U035AD2B	17.8	9.9	1 3/8 x 4 5/8
49000	DCMC493U035AE2B	15.5	11.2	1 3/8 x 5 1/8
53000	DCMC533U035BB2B	15.9	11.6	2 x 3 1/8
54000	DCMC543U035EJ2B	13.2	13.2	1 3/4 x 3 5/8
56000	DCMC563U035AF2B	14.1	13.3	1 3/8 x 5 5/8
63000	DCMC633U035CH2B	14.8	13.4	2 1/2 x 2 5/8
66000	DCMC663U035EC2B	11.8	11.5	1 3/4 x 4 1/8
69000	DCMC693U035BJ2B	13.2	11.7	2 x 3 5/8
78000	DCMC783U035ED2B	10.6	13.9	1 3/4 x 4 5/8
84000	DCMC843U035BC2B	11.6	14.0	2 x 4 1/8
88000	DCMC883U035CB2B	11.5	14.7	2 1/2 x 3 1/8
90000	DCMC903U035EE2B	9.8	16.6	1 3/4 x 5 1/8
99000	DCMC993U035BD2B	10.5	16.6	2 x 4 5/8
100000	DCMC104U035EF2B	9.4	18.1	1 3/4 x 5 5/8
110000	DCMC114U035BE2B	9.8	15.6	2 x 5 1/8
110000	DCMC114U035CJ2B	9.4	16.9	2 1/2 x 3 5/8
130000	DCMC134U035BF2B	9.4	17.9	2 x 5 5/8
130000	DCMC134U035DB2B	6.9	21.8	3 x 3 1/8
140000	DCMC144U035CC2B	8.2	20.6	2 1/2 x 4 1/8
160000	DCMC164U035CD2B	7.4	22.5	2 1/2 x 4 5/8
170000	DCMC174U035DJ2B	5.7	26.4	3 x 3 5/8
190000	DCMC194U035CE2B	6.8	22.3	2 1/2 x 5 1/8
210000	DCMC214U035CF2B	6.1	24.7	2 1/2 x 5 5/8
210000	DCMC214U035DC2B	5.2	28.0	3 x 4 1/8
240000	DCMC244U035DD2D	4.7	30.5	3 x 4 5/8
280000	DCMC284U035DE2D	4.4	32.6	3 x 5 1/8
300000	DCMC304U035FC2D	4.9	31.7	3 1/2 x 4 1/8
320000	DCMC324U035DF2D	4.0	35.5	3 x 5 5/8
340000	DCMC344U035DP2D	3.9	40.9	3 x 5 7/8
350000	DCMC354U035FD2D	4.5	33.0	3 1/2 x 4 5/8
410000	DCMC414U035FE2D	4.0	36.2	3 1/2 x 5 1/8
460000	DCMC464U035FF2D	3.6	39.2	3 1/2 x 5 5/8
470000	DCMC474U035DN2D	3.8	39.8	3 x 7 5/8
490000	DCMC494U035FP2D	3.5	41.1	3 1/2 x 5 7/8

Cap. (µF)	Catalog Part Number	ESR Max. @ 25 °C 120 Hz (mΩ)	Ripple Max. @ 85°C 120 Hz (A)	Nominal Size D x L (inches)
550000	DCMC554U035DG2D	3.6	40.9	3 x 8 5/8
680000	DCMC684U035FN2D	3.4	45.7	3 1/2 x 7 5/8
790000	DCMC794U035FG2D	3.3	48.4	3 1/2 x 8 5/8
<b>50 Vdc (65 Vdc Surge)</b>				
5900	DCMC592U050AK2B	47.9	4.1	1 3/8 x 1 5/8
10000	DCMC103U050AA2B	30.9	5.6	1 3/8 x 2 1/8
12000	DCMC123U050AH2B	25.9	6.7	1 3/8 x 2 5/8
16000	DCMC163U050AB2B	23.6	7.4	1 3/8 x 3 1/8
18000	DCMC183U050EA2B	22.8	8.0	1 3/4 x 2 1/8
21000	DCMC213U050AJ2B	19.6	9.0	1 3/8 x 3 5/8
21000	DCMC213U050EH2B	20.2	9.3	1 3/4 x 2 5/8
23000	DCMC233U050BA2B	25.3	8.6	2 x 2 1/8
26000	DCMC263U050AC2B	18.7	10.4	1 3/8 x 4 1/8
29000	DCMC293U050BH2B	20.8	8.0	2 x 2 5/8
30000	DCMC303U050EB2B	15.6	9.9	1 3/4 x 3 1/8
31000	DCMC313U050AD2B	17.9	9.9	1 3/8 x 4 5/8
35000	DCMC353U050AE2B	15.9	11.0	1 3/8 x 5 1/8
38000	DCMC383U050EJ2B	13.5	12.5	1 3/4 x 3 5/8
38000	DCMC383U050BB2B	16.3	11.9	2 x 3 1/8
40000	DCMC403U050AF2B	14.4	13.1	1 3/8 x 5 5/8
45000	DCMC453U050CH2B	15.1	13.3	2 1/2 x 2 5/8
47000	DCMC473U050EC2B	12.0	11.4	1 3/4 x 4 1/8
49000	DCMC493U050BJ2B	13.6	11.6	2 x 3 5/8
56000	DCMC563U050ED2B	10.8	13.8	1 3/4 x 4 5/8
60000	DCMC603U050BC2B	11.9	13.8	2 x 4 1/8
63000	DCMC633U050CB2B	12.0	14.4	2 1/2 x 3 1/8
64000	DCMC643U050EE2B	9.8	16.6	1 3/4 x 5 1/8
71000	DCMC713U050BD2B	10.8	16.4	2 x 4 5/8
73000	DCMC733U050EF2B	9.5	18.0	1 3/4 x 5 5/8
81000	DCMC813U050CJ2B	10.3	15.2	2 1/2 x 3 5/8
82000	DCMC823U050BE2B	10.0	16.4	2 x 5 1/8
93000	DCMC933U050BF2B	9.5	17.7	2 x 5 5/8
94000	DCMC943U050DB2B	9.1	18.9	3 x 3 1/8
99000	DCMC993U050CC2B	8.9	19.8	2 1/2 x 4 1/8
120000	DCMC124U050CD2B	7.9	21.8	2 1/2 x 4 5/8
120000	DCMC124U050DJ2B	7.7	22.7	3 x 3 5/8
130000	DCMC134U050CE2B	7.2	21.7	2 1/2 x 5 1/8
150000	DCMC154U050CF2B	6.7	23.7	2 1/2 x 5 5/8
150000	DCMC154U050DC2B	6.9	24.2	3 x 4 1/8
170000	DCMC174U050DD2B	6.1	26.7	3 x 4 5/8
200000	DCMC204U050DE2B	5.9	28.1	3 x 5 1/8
200000	DCMC204U050FC2D	6.4	27.9	3 1/2 x 4 1/8
230000	DCMC234U050DF2D	5.6	30.0	3 x 5 5/8
230000	DCMC234U050FD2D	5.7	33.8	3 1/2 x 4 5/8
240000	DCMC244U050DP2D	5.4	30.2	3 x 5 7/8
270000	DCMC274U050FE2D	5.4	31.3	3 1/2 x 5 1/8
310000	DCMC314U050FF2D	5.1	33.2	3 1/2 x 5 5/8
320000	DCMC324U050FP2D	4.9	34.8	3 1/2 x 5 7/8

# Type DCMC 85 °C High Capacitance, Screw Terminal, Aluminum

## Highest Capacitance Screw Terminal Type

Cap. (µF)	Catalog Part Number	ESR Max. @ 25 °C 120 Hz (mΩ)	Ripple Max. @ 85°C 120 Hz (A)	Nominal Size D x L (inches)
350000	DCMC354U050DN2D	4.5	37.5	3 x 7 5/8
390000	DCMC394U050DG2D	4.1	38.6	3 x 8 5/8
450000	DCMC454U050FN2D	4.2	41.3	3 1/2 x 7 5/8
520000	DCMC524U050FG2D	3.8	44.9	3 1/2 x 8 5/8
<b>63 Vdc (75 Vdc Surge)</b>				
4100	DCMC412U063AK2B	60.6	3.6	1 3/8 x 1 5/8
7000	DCMC702U063AA2B	39.0	5.0	1 3/8 x 2 1/8
8300	DCMC832U063AH2B	32.7	5.9	1 3/8 x 2 5/8
12000	DCMC123U063AB2B	28.6	6.8	1 3/8 x 3 1/8
13000	DCMC133U063EA2B	27.9	7.2	1 3/4 x 2 1/8
15000	DCMC153U063AJ2B	26.1	7.8	1 3/8 x 3 5/8
15000	DCMC153U063EH2B	25.6	8.2	1 3/4 x 2 5/8
15000	DCMC153U063BA2B	28.0	8.2	2 x 2 1/8
18000	DCMC183U063AC2B	22.0	9.6	1 3/8 x 4 1/8
18000	DCMC183U063BH2B	22.6	7.7	2 x 2 5/8
21000	DCMC213U063AD2B	19.3	8.9	1 3/8 x 4 5/8
21000	DCMC213U063EB2B	19.5	9.4	1 3/4 x 3 1/8
25000	DCMC253U063AE2B	17.3	10.6	1 3/8 x 5 1/8
25000	DCMC253U063BB2B	18.1	10.8	2 x 3 1/8
27000	DCMC273U063EJ2B	16.2	11.9	1 3/4 x 3 5/8
28000	DCMC283U063AF2B	15.8	12.5	1 3/8 x 5 5/8
29000	DCMC293U063CH2B	26.8	9.9	2 1/2 x 2 5/8
32000	DCMC323U063BJ2B	15.1	10.2	2 x 3 5/8
33000	DCMC333U063EC2B	14.2	11.3	1 3/4 x 4 1/8
39000	DCMC393U063ED2B	12.8	12.7	1 3/4 x 4 5/8
39000	DCMC393U063BC2B	13.3	13.1	2 x 4 1/8
41000	DCMC413U063CB2B	19.3	11.4	2 1/2 x 3 1/8
45000	DCMC453U063EE2B	11.8	15.1	1 3/4 x 5 1/8
46000	DCMC463U063BD2B	12.1	15.5	2 x 4 5/8
51000	DCMC513U063EF2B	11.2	16.6	1 3/4 x 5 5/8
52000	DCMC523U063CJ2B	17.1	11.8	2 1/2 x 3 5/8
53000	DCMC533U063BE2B	11.3	15.5	2 x 5 1/8
60000	DCMC603U063BF2B	10.7	16.7	2 x 5 5/8
61000	DCMC613U063DB2B	14.9	14.8	3 x 3 1/8
64000	DCMC643U063CC2B	13.7	16.0	2 1/2 x 4 1/8
76000	DCMC763U063CD2B	11.8	17.8	2 1/2 x 4 5/8
78000	DCMC783U063DJ2B	12.1	18.1	3 x 3 5/8
87000	DCMC873U063CE2B	11.0	17.6	2 1/2 x 5 1/8
95000	DCMC953U063DC2B	10.8	18.6	3 x 4 1/8
99000	DCMC993U063CF2B	10.5	19.7	2 1/2 x 5 5/8
110000	DCMC114U063DD2B	9.9	21.0	3 x 4 5/8
130000	DCMC134U063DE2B	8.8	23.0	3 x 5 1/8
130000	DCMC134U063FC2D	9.9	22.3	3 1/2 x 4 1/8
150000	DCMC154U063DF2B	7.9	25.3	3 x 5 5/8
150000	DCMC154U063FD2D	9.0	26.8	3 1/2 x 4 5/8
160000	DCMC164U063DP2B	7.5	25.5	3 x 5 7/8
180000	DCMC184U063FE2D	7.9	25.7	3 1/2 x 5 1/8
200000	DCMC204U063FF2D	7.2	28.0	3 1/2 x 5 5/8

Cap. (µF)	Catalog Part Number	ESR Max. @ 25 °C 120 Hz (mΩ)	Ripple Max. @ 85°C 120 Hz (A)	Nominal Size D x L (inches)
210000	DCMC214U063FP2D	6.8	29.4	3 1/2 x 5 7/8
230000	DCMC234U063DN2D	6.5	31.2	3 x 7 5/8
250000	DCMC254U063DG2D	5.7	32.6	3 x 8 5/8
300000	DCMC304U063FN2D	5.8	35.3	3 1/2 x 7 5/8
350000	DCMC354U063FG2D	5.2	38.5	3 1/2 x 8 5/8
<b>75 Vdc (95 Vdc Surge)</b>				
3200	DCMC322U075AK2B	76.2	3.2	1 3/8 x 1 5/8
5300	DCMC532U075AA2B	50.7	4.4	1 3/8 x 2 1/8
6400	DCMC642U075AH2B	41.7	5.2	1 3/8 x 2 5/8
9000	DCMC902U075AB2B	38.6	5.8	1 3/8 x 3 1/8
9900	DCMC992U075EA2B	55.6	5.1	1 3/4 x 2 1/8
12000	DCMC123U075AJ2B	34.3	6.8	1 3/8 x 3 5/8
12000	DCMC123U075EH2B	47.3	6.1	1 3/4 x 2 5/8
12000	DCMC123U075BA2B	34.8	7.4	2 x 2 1/8
14000	DCMC143U075AC2B	30.5	8.1	1 3/8 x 4 1/8
14000	DCMC143U075BH2B	27.5	6.9	2 x 2 5/8
16000	DCMC163U075EB2B	34.1	6.7	1 3/4 x 3 1/8
17000	DCMC173U075AD2B	26.2	8.2	1 3/8 x 4 5/8
19000	DCMC193U075AE2B	23.8	9.0	1 3/8 x 5 1/8
19000	DCMC193U075BB2B	21.4	10.0	2 x 3 1/8
21000	DCMC213U075EJ2B	26.9	9.3	1 3/4 x 3 5/8
22000	DCMC223U075AF2B	21.4	10.8	1 3/8 x 5 5/8
23000	DCMC233U075CH2B	30.0	9.4	2 1/2 x 2 5/8
25000	DCMC253U075BJ2B	18.0	9.3	2 x 3 5/8
26000	DCMC263U075EC2B	22.3	9.0	1 3/4 x 4 1/8
30000	DCMC303U075ED2B	19.2	10.4	1 3/4 x 4 5/8
30000	DCMC303U075BC2B	15.6	12.1	2 x 4 1/8
32000	DCMC323U075CB2B	21.6	10.7	2 1/2 x 3 1/8
35000	DCMC353U075EE2B	16.9	12.6	1 3/4 x 5 1/8
35000	DCMC353U075BD2B	13.9	14.4	2 x 4 5/8
40000	DCMC403U075EF2B	15.2	14.3	1 3/4 x 5 5/8
41000	DCMC413U075BE2B	12.8	13.7	2 x 5 1/8
41000	DCMC413U075CJ2B	17.8	12.3	2 1/2 x 3 5/8
46000	DCMC463U075BF2B	12.0	15.8	2 x 5 5/8
47000	DCMC473U075DB2B	18.0	13.4	3 x 3 1/8
50000	DCMC503U075CC2B	15.1	15.2	2 1/2 x 4 1/8
59000	DCMC593U075CD2B	13.5	16.7	2 1/2 x 4 5/8
61000	DCMC613U075DJ2B	14.4	16.6	3 x 3 5/8
68000	DCMC683U075CE2B	12.0	16.8	2 1/2 x 5 1/8
74000	DCMC743U075DC2B	12.9	17.0	3 x 4 1/8
77000	DCMC773U075CF2B	11.2	19.0	2 1/2 x 5 5/8
88000	DCMC883U075DD2B	11.8	19.2	3 x 4 5/8
100000	DCMC104U075DE2B	10.4	21.1	3 x 5 1/8
100000	DCMC104U075FC2D	11.8	20.4	3 1/2 x 4 1/8
110000	DCMC114U075DF2B	9.4	23.3	3 x 5 5/8
120000	DCMC124U075DP2B	8.9	26.9	3 x 5 7/8
120000	DCMC124U075FD2D	10.7	21.4	3 1/2 x 4 5/8
140000	DCMC144U075FE2D	9.4	23.7	3 1/2 x 5 1/8

# Type DCMC 85 °C High Capacitance, Screw Terminal, Aluminum

## Highest Capacitance Screw Terminal Type

Cap. (µF)	Catalog Part Number	ESR Max. @ 25 °C 120 Hz (mΩ)	Ripple Max. @ 85°C 120 Hz (A)	Nominal Size D x L (inches)
160000	DCMC164U075FF2D	8.4	25.7	3 1/2 x 5 5/8
170000	DCMC174U075DN2D	7.7	28.1	3 x 7 5/8
170000	DCMC174U075FP2D	8.1	27.1	3 1/2 x 5 7/8
200000	DCMC204U075DG2B	6.8	29.8	3 x 8 5/8
230000	DCMC234U075FN2D	6.9	32.3	3 1/2 x 7 5/8
270000	DCMC274U075FG2D	6.2	35.2	3 1/2 x 8 5/8
<b>100 Vdc (125 Vdc Surge)</b>				
1900	DCMC192U100AK2B	98.4	2.9	1 3/8 x 1 5/8
3100	DCMC312U100AA2B	60.2	4.0	1 3/8 x 2 1/8
3900	DCMC392U100AH2B	51.0	4.7	1 3/8 x 2 5/8
5500	DCMC552U100AB2B	43.4	5.5	1 3/8 x 3 1/8
6000	DCMC602U100EA2B	62.0	4.8	1 3/4 x 2 1/8
6300	DCMC632U100BA2B	51.8	5.6	2 x 2 1/8
7000	DCMC702U100AJ2B	36.5	6.9	1 3/8 x 3 5/8
7100	DCMC712U100EH2B	52.8	6.0	1 3/4 x 2 5/8
8600	DCMC862U100AC2B	33.3	7.8	1 3/8 x 4 1/8
9000	DCMC902U100BH2B	37.8	5.9	2 x 2 5/8
9900	DCMC992U100EB2B	38.0	6.4	1 3/4 x 3 1/8
10000	DCMC103U100AD2B	31.1	7.5	1 3/8 x 4 5/8
12000	DCMC123U100AE2B	30.0	8.0	1 3/8 x 5 1/8
13000	DCMC133U100AF2B	29.0	8.6	1 3/8 x 5 5/8
13000	DCMC133U100EJ2B	29.9	8.8	1 3/4 x 3 5/8
13000	DCMC133U100BB2B	30.6	9.0	2 x 3 1/8
15000	DCMC153U100CH2B	33.7	8.9	2 1/2 x 2 5/8
16000	DCMC163U100EC2B	24.8	8.0	1 3/4 x 4 1/8
16000	DCMC163U100BJ2B	22.3	9.0	2 x 3 5/8
18000	DCMC183U100ED2B	21.2	9.8	1 3/4 x 4 5/8
20000	DCMC203U100BC2B	19.9	10.7	2 x 4 1/8
21000	DCMC213U100EE2B	18.7	11.5	1 3/4 x 5 1/8
21000	DCMC213U100CB2B	23.4	10.7	2 1/2 x 3 1/8
23000	DCMC233U100BD2B	17.7	12.8	2 x 4 5/8
24000	DCMC243U100EF2B	16.8	13.6	1 3/4 x 5 5/8
27000	DCMC273U100BE2B	15.6	12.4	2 x 5 1/8
27000	DCMC273U100CJ2B	19.1	11.9	2 1/2 x 3 5/8
31000	DCMC313U100BF2B	14.9	14.1	2 x 5 5/8
31000	DCMC313U100DB2B	19.9	12.8	3 x 3 1/8
33000	DCMC333U100CC2B	16.5	14.6	2 1/2 x 4 1/8
39000	DCMC393U100CD2B	14.7	16.0	2 1/2 x 4 5/8
40000	DCMC403U100DJ2B	16.4	15.6	3 x 3 5/8
45000	DCMC453U100CE2B	13.4	15.9	2 1/2 x 5 1/8
49000	DCMC493U100DC2B	14.4	16.1	3 x 4 1/8
51000	DCMC513U100CF2B	12.5	18.0	2 1/2 x 5 5/8
58000	DCMC583U100DD2B	13.0	18.3	3 x 4 5/8
67000	DCMC673U100DE2B	12.0	19.7	3 x 5 1/8
67000	DCMC673U100FC2D	13.4	19.2	3 1/2 x 4 1/8
76000	DCMC763U100DF2B	11.2	21.3	3 x 5 5/8
79000	DCMC793U100FD2D	12.1	23.1	3 1/2 x 4 5/8
80000	DCMC803U100DP2B	11.1	21.0	3 x 5 7/8

Cap. (µF)	Catalog Part Number	ESR Max. @ 25 °C 120 Hz (mΩ)	Ripple Max. @ 85°C 120 Hz (A)	Nominal Size D x L (inches)
92000	DCMC923U100FE2D	10.9	22.0	3 1/2 x 5 1/8
100000	DCMC104U100FF2D	10.2	23.4	3 1/2 x 5 5/8
110000	DCMC114U100DN2B	9.2	25.8	3 x 7 5/8
110000	DCMC114U100FP2D	10.0	24.3	3 1/2 x 5 7/8
130000	DCMC134U100DG2B	8.2	27.3	3 x 8 5/8
150000	DCMC154U100FN2D	8.3	29.5	3 1/2 x 7 5/8
180000	DCMC184U100FG2D	7.3	32.3	3 1/2 x 8 5/8
<b>160 Vdc (200 Vdc Surge)</b>				
1100	DCMC112T160AK2B	149.6	2.3	1 3/8 x 1 5/8
1800	DCMC182T160AA2B	93.0	3.3	1 3/8 x 2 1/8
2300	DCMC232T160AH2B	70.5	4.0	1 3/8 x 2 5/8
3200	DCMC322T160AB2B	58.5	4.7	1 3/8 x 3 1/8
3500	DCMC352T160EA2B	62.0	4.8	1 3/4 x 2 1/8
3700	DCMC372T160BA2B	70.5	4.8	2 x 2 1/8
4100	DCMC412T160AJ2B	50.2	5.9	1 3/8 x 3 5/8
4100	DCMC412T160EH2B	52.8	6.0	1 3/4 x 2 5/8
5000	DCMC502T160AC2B	42.9	6.9	1 3/8 x 4 1/8
5300	DCMC532T160BH2B	46.5	5.3	2 x 2 5/8
5800	DCMC582T160EB2B	38.0	6.4	1 3/4 x 3 1/8
5900	DCMC592T160AD2B	37.7	6.8	1 3/8 x 4 5/8
6800	DCMC682T160AE2B	34.7	7.5	1 3/8 x 5 1/8
7400	DCMC742T160EJ2B	29.9	8.4	1 3/4 x 3 5/8
7400	DCMC742T160BB2B	33.5	8.3	2 x 3 1/8
7700	DCMC772T160AF2B	32.2	8.8	1 3/8 x 5 5/8
8300	DCMC832T160CH2B	30.1	9.4	2 1/2 x 2 5/8
9100	DCMC912T160EC2B	24.8	8.0	1 3/4 x 4 1/8
9500	DCMC952T160BJ2B	26.4	8.3	2 x 3 5/8
11000	DCMC113T160ED2B	21.2	9.8	1 3/4 x 4 5/8
12000	DCMC123T160EE2B	18.7	11.0	1 3/4 x 5 1/8
12000	DCMC123T160BC2B	21.9	10.7	2 x 4 1/8
12000	DCMC123T160CB2B	21.3	11.2	2 1/2 x 3 1/8
14000	DCMC143T160EF2B	16.8	13.1	1 3/4 x 5 5/8
14000	DCMC143T160BD2B	18.8	12.8	2 x 4 5/8
15000	DCMC153T160CJ2B	17.0	11.9	2 1/2 x 3 5/8
16000	DCMC163T160BE2B	16.6	12.8	2 x 5 1/8
17000	DCMC173T160DB2B	14.7	14.3	3 x 3 1/8
18000	DCMC183T160BF2B	14.9	14.8	2 x 5 5/8
18000	DCMC183T160CC2B	14.1	15.8	2 1/2 x 4 1/8
22000	DCMC223T160CD2B	11.9	17.8	2 1/2 x 4 5/8
22000	DCMC223T160DJ2B	11.5	18.6	3 x 3 5/8
25000	DCMC253T160CE2B	10.7	17.8	2 1/2 x 5 1/8
27000	DCMC273T160DC2B	9.6	19.7	3 x 4 1/8
28000	DCMC283T160CF2B	9.6	20.5	2 1/2 x 5 5/8
32000	DCMC323T160DD2B	8.2	23.0	3 x 4 5/8
37000	DCMC373T160DE2B	7.3	25.3	3 x 5 1/8
37000	DCMC373T160FC2D	9.2	23.2	3 1/2 x 4 1/8
42000	DCMC423T160DF2B	6.5	27.9	3 x 5 5/8
44000	DCMC443T160FD2D	7.9	28.6	3 1/2 x 4 5/8



# Type DCMC 85 °C High Capacitance, Screw Terminal, Aluminum

## Highest Capacitance Screw Terminal Type

Cap. (µF)	Catalog Part Number	ESR Max. @ 25 °C 120 Hz (mΩ)	Ripple Max. @ 85°C 120 Hz (A)	Nominal Size D x L (inches)
45000	DCMC453T160DP2B	6.2	28.1	3 x 5 7/8
51000	DCMC513T160FE2D	6.9	27.5	3 1/2 x 5 1/8
58000	DCMC583T160FF2D	6.2	30.0	3 1/2 x 5 5/8
61000	DCMC613T160FP2D	5.9	31.6	3 1/2 x 5 7/8
62000	DCMC623T160DN2D	5.1	34.9	3 x 7 5/8
72000	DCMC723T160DG2D	4.3	37.5	3 x 8 5/8
85000	DCMC853T160FN2D	4.9	38.8	3 1/2 x 7 5/8
99000	DCMC993T160FG2D	4.2	42.8	3 1/2 x 8 5/8
<b>200 Vdc (250 Vdc Surge)</b>				
680	DCMC681T200AK2B	205.8	2.0	1 3/8 x 1 5/8
1000	DCMC102T200AA2B	140.3	2.6	1 3/8 x 2 1/8
1500	DCMC152T200AH2B	100.5	3.4	1 3/8 x 2 5/8
1800	DCMC182T200AB2B	78.5	4.1	1 3/8 x 3 1/8
1900	DCMC192T200EA2B	79.1	4.3	1 3/4 x 2 1/8
2200	DCMC222T200AJ2B	63.9	5.0	1 3/8 x 3 5/8
2400	DCMC242T200EH2B	62.5	5.3	1 3/4 x 2 5/8
2500	DCMC252T200BA2B	82.0	4.8	2 x 2 1/8
2700	DCMC272T200AC2B	51.7	6.2	1 3/8 x 4 1/8
3100	DCMC312T200EB2B	48.4	5.2	1 3/4 x 3 1/8
3300	DCMC332T200AD2B	43.2	6.0	1 3/8 x 4 5/8
3300	DCMC332T200BH2B	61.0	5.3	2 x 2 5/8
3800	DCMC382T200EJ2B	37.9	7.2	1 3/4 x 3 5/8
3900	DCMC392T200AE2B	37.8	7.5	1 3/8 x 5 1/8
4300	DCMC432T200BB2B	46.1	7.1	2 x 3 1/8
4500	DCMC452T200AF2B	33.4	8.6	1 3/8 x 5 5/8
4600	DCMC462T200EC2B	31.3	9.2	1 3/4 x 4 1/8
5400	DCMC542T200ED2B	26.8	7.7	1 3/4 x 4 5/8
5500	DCMC552T200CH2B	42.2	6.6	2 1/2 x 2 5/8
5600	DCMC562T200BJ2B	36.2	7.5	2 x 3 5/8
6100	DCMC612T200EE2B	23.5	9.9	1 3/4 x 5 1/8
6900	DCMC692T200EF2B	21.0	10.9	1 3/4 x 5 5/8
6900	DCMC692T200BC2B	28.5	9.7	2 x 4 1/8
7100	DCMC712T200CB2B	31.2	9.6	2 1/2 x 3 1/8
8200	DCMC822T200BD2B	24.4	11.2	2 x 4 5/8
9100	DCMC912T200BE2B	21.7	10.5	2 x 5 1/8
10000	DCMC103T200BF2B	19.6	11.7	2 x 5 5/8
10000	DCMC103T200CJ2B	22.3	11.6	2 1/2 x 3 5/8
11000	DCMC113T200CC2B	20.3	12.7	2 1/2 x 4 1/8
11000	DCMC113T200DB2B	30.3	10.8	3 x 3 1/8
12000	DCMC123T200CD2B	17.3	14.7	2 1/2 x 4 5/8
13000	DCMC133T200CE2B	15.8	15.9	2 1/2 x 5 1/8
13000	DCMC133T200DJ2B	23.7	12.0	3 x 3 5/8
15000	DCMC153T200CF2B	13.7	16.5	2 1/2 x 5 5/8
15000	DCMC153T200DC2B	19.7	14.3	3 x 4 1/8
18000	DCMC183T200DD2B	16.9	16.1	3 x 4 5/8
21000	DCMC213T200FC2B	17.1	16.5	3 1/2 x 4 1/8
22000	DCMC223T200DE2B	14.8	18.2	3 x 5 1/8
24000	DCMC243T200DF2B	13.3	19.5	3 x 5 5/8

Cap. (µF)	Catalog Part Number	ESR Max. @ 25 °C 120 Hz (mΩ)	Ripple Max. @ 85°C 120 Hz (A)	Nominal Size D x L (inches)
25000	DCMC253T200FD2B	15.3	20.5	3 1/2 x 4 5/8
26000	DCMC263T200DP2B	12.7	19.7	3 x 5 7/8
28000	DCMC283T200FE2B	13.4	19.8	3 1/2 x 5 1/8
31000	DCMC313T200FF2B	12.0	21.6	3 1/2 x 5 5/8
33000	DCMC333T200DN2B	10.8	23.7	3 x 7 5/8
33000	DCMC333T200FP2D	11.5	22.7	3 1/2 x 5 7/8
37000	DCMC373T200DG2B	9.6	25.2	3 x 8 5/8
44000	DCMC443T200FN2D	9.3	28.2	3 1/2 x 7 5/8
51000	DCMC513T200FG2D	7.9	31.1	3 1/2 x 8 5/8
<b>250 Vdc (300 Vdc Surge)</b>				
470	DCMC471T250AK2B	259.7	1.8	1 3/8 x 1 5/8
820	DCMC821T250AA2B	156.4	2.5	1 3/8 x 2 1/8
1200	DCMC122T250AH2B	118.7	3.1	1 3/8 x 2 5/8
1400	DCMC142T250EA2B	99.0	3.6	1 3/4 x 2 1/8
1500	DCMC152T250AB2B	88.0	4.1	1 3/8 x 3 1/8
1800	DCMC182T250EH2B	83.3	4.4	1 3/4 x 2 5/8
1800	DCMC182T250BA2B	94.7	4.3	2 x 2 1/8
1900	DCMC192T250AJ2B	69.5	5.2	1 3/8 x 3 5/8
2300	DCMC232T250AC2B	57.9	5.9	1 3/8 x 4 1/8
2300	DCMC232T250EB2B	61.3	4.6	1 3/4 x 3 1/8
2400	DCMC242T250AD2B	51.4	5.5	1 3/8 x 4 5/8
2500	DCMC252T250BH2B	65.7	5.2	2 x 2 5/8
2700	DCMC272T250AE2B	44.0	6.6	1 3/8 x 5 1/8
3000	DCMC302T250EJ2B	48.7	6.6	1 3/4 x 3 5/8
3300	DCMC332T250BB2B	46.2	7.1	2 x 3 1/8
3400	DCMC342T250AF2B	38.3	8.0	1 3/8 x 5 5/8
3700	DCMC372T250EC2B	40.5	8.1	1 3/4 x 4 1/8
3900	DCMC392T250ED2B	34.8	6.7	1 3/4 x 4 5/8
3900	DCMC392T250BJ2B	38.2	6.9	2 x 3 5/8
4100	DCMC412T250CH2B	51.8	6.3	2 1/2 x 2 5/8
4500	DCMC452T250EE2B	30.6	8.6	1 3/4 x 5 1/8
4700	DCMC472T250BC2B	31.5	8.9	2 x 4 1/8
5000	DCMC502T250EF2B	27.3	9.9	1 3/4 x 5 5/8
5200	DCMC522T250CB2B	32.1	9.5	2 1/2 x 3 1/8
5600	DCMC562T250BD2B	26.9	10.7	2 x 4 5/8
6200	DCMC622T250BE2B	23.6	10.1	2 x 5 1/8
6400	DCMC642T250CJ2B	25.1	10.4	2 1/2 x 3 5/8
6800	DCMC682T250BF2B	21.2	11.9	2 x 5 5/8
7800	DCMC782T250DB2B	27.6	10.9	3 x 3 1/8
8200	DCMC822T250CC2B	20.8	13.0	2 1/2 x 4 1/8
10000	DCMC103T250CD2B	17.8	14.5	2 1/2 x 4 5/8
10000	DCMC103T250DJ2B	21.6	13.6	3 x 3 5/8
11000	DCMC113T250CE2B	15.5	14.8	2 1/2 x 5 1/8
12000	DCMC123T250CF2B	13.8	16.5	2 1/2 x 5 5/8
12000	DCMC123T250DC2B	17.6	15.2	3 x 4 1/8
13000	DCMC133T250DD2B	16.3	16.4	3 x 4 5/8
15000	DCMC153T250DE2B	14.3	18.0	3 x 5 1/8
16000	DCMC163T250FC2D	19.5	15.9	3 1/2 x 4 1/8

# Type DCMC 85 °C High Capacitance, Screw Terminal, Aluminum

## Highest Capacitance Screw Terminal Type

Cap. (µF)	Catalog Part Number	ESR Max. @ 25 °C 120 Hz (mΩ)	Ripple Max. @ 85°C 120 Hz (A)	Nominal Size D x L (inches)
18000	DCMC183T250DF2B	12.0	20.6	3 x 5 5/8
18000	DCMC183T250FD2D	17.1	19.4	3 1/2 x 4 5/8
19000	DCMC193T250DP2B	11.5	20.6	3 x 5 7/8
21000	DCMC213T250FE2D	15.1	18.7	3 1/2 x 5 1/8
23000	DCMC233T250FF2D	13.4	20.4	3 1/2 x 5 5/8
24000	DCMC243T250FP2D	12.9	21.4	3 1/2 x 5 7/8
27000	DCMC273T250DN2D	9.5	27.2	3 x 7 5/8
30000	DCMC303T250DG2B	7.0	29.6	3 x 8 5/8
33000	DCMC333T250FN2D	10.6	26.2	3 1/2 x 7 5/8
38000	DCMC383T250FG2D	9.2	28.8	3 1/2 x 8 5/8
<b>300 Vdc (350 Vdc Surge)</b>				
330	DCMC331T300AK2B	418.1	1.4	1 3/8 x 1 5/8
600	DCMC601T300AA2B	231.4	2.1	1 3/8 x 2 1/8
730	DCMC731T300AH2B	188.8	2.5	1 3/8 x 2 5/8
1000	DCMC102T300AB2B	137.5	3.1	1 3/8 x 3 1/8
1000	DCMC102T300EA2B	139.3	3.2	1 3/4 x 2 1/8
1200	DCMC122T300EH2B	117.2	3.7	1 3/4 x 2 5/8
1200	DCMC122T300BA2B	131.1	3.6	2 x 2 1/8
1300	DCMC132T300AJ2B	106.8	4.2	1 3/8 x 3 5/8
1500	DCMC152T300AC2B	90.4	4.7	1 3/8 x 4 1/8
1500	DCMC152T300BH2B	102.6	3.6	2 x 2 5/8
1700	DCMC172T300EB2B	84.5	4.3	1 3/4 x 3 1/8
1800	DCMC182T300AD2B	77.4	4.7	1 3/8 x 4 5/8
2100	DCMC212T300AE2B	65.7	5.4	1 3/8 x 5 1/8
2100	DCMC212T300EJ2B	68.3	5.6	1 3/4 x 3 5/8
2200	DCMC222T300BB2B	71.1	5.7	2 x 3 1/8
2300	DCMC232T300AF2B	60.3	6.4	1 3/8 x 5 5/8
2600	DCMC262T300EC2B	56.7	6.8	1 3/4 x 4 1/8
2600	DCMC262T300CH2B	60.5	5.1	2 1/2 x 2 5/8
2800	DCMC282T300BJ2B	55.5	5.7	2 x 3 5/8
3000	DCMC302T300ED2B	48.5	6.5	1 3/4 x 4 5/8
3300	DCMC332T300CB2B	46.5	7.0	2 1/2 x 3 1/8
3400	DCMC342T300BC2B	45.7	7.4	2 x 4 1/8
3500	DCMC352T300EE2B	42.5	8.0	1 3/4 x 5 1/8
3900	DCMC392T300EF2B	37.9	8.7	1 3/4 x 5 5/8
4000	DCMC402T300BD2B	38.9	8.9	2 x 4 5/8
4200	DCMC422T300CJ2B	38.1	7.9	2 1/2 x 3 5/8
4600	DCMC462T300BE2B	34.0	8.9	2 x 5 1/8
4800	DCMC482T300DB2B	42.8	8.4	3 x 3 1/8
5200	DCMC522T300CC2B	29.9	10.4	2 1/2 x 4 1/8
5300	DCMC532T300BF2B	30.2	10.8	2 x 5 5/8
6000	DCMC602T300DJ2B	34.0	10.5	3 x 3 5/8
6100	DCMC612T300CD2B	25.5	12.5	2 1/2 x 4 5/8
7100	DCMC712T300CE2B	22.2	12.3	2 1/2 x 5 1/8
7400	DCMC742T300DC2B	26.2	11.9	3 x 4 1/8
8000	DCMC802T300CF2B	19.8	14.3	2 1/2 x 5 5/8
8700	DCMC872T300DD2B	23.6	13.6	3 x 4 5/8
10000	DCMC103T300DE2B	20.5	15.1	3 x 5 1/8

Cap. (µF)	Catalog Part Number	ESR Max. @ 25 °C 120 Hz (mΩ)	Ripple Max. @ 85°C 120 Hz (A)	Nominal Size D x L (inches)
10000	DCMC103T300FC2D	21.0	15.3	3 1/2 x 4 1/8
11000	DCMC113T300DF2B	18.0	16.8	3 x 5 5/8
12000	DCMC123T300DP2B	17.0	19.5	3 x 5 7/8
12000	DCMC123T300FD2D	18.2	16.4	3 1/2 x 4 5/8
13000	DCMC133T300FE2D	16.0	18.1	3 1/2 x 5 1/8
15000	DCMC153T300FF2D	14.3	19.8	3 1/2 x 5 5/8
16000	DCMC163T300DN2B	13.2	21.8	3 x 7 5/8
16000	DCMC163T300FP2D	13.5	20.9	3 1/2 x 5 7/8
19000	DCMC193T300DG2B	10.8	23.7	3 x 8 5/8
22000	DCMC223T300FN2D	11.0	25.9	3 1/2 x 7 5/8
26000	DCMC263T300FG2D	9.3	28.6	3 1/2 x 8 5/8
<b>350 Vdc (400 Vdc Surge)</b>				
220	DCMC221T350AK2B	605.4	1.2	1 3/8 x 1 5/8
430	DCMC431T350AA2B	378.8	1.6	1 3/8 x 2 1/8
510	DCMC511T350AH2B	253.0	2.1	1 3/8 x 2 5/8
680	DCMC681T350AB2B	190.2	2.6	1 3/8 x 3 1/8
760	DCMC761T350EA2B	176.6	2.9	1 3/4 x 2 1/8
860	DCMC861T350AJ2B	152.5	3.2	1 3/8 x 3 5/8
920	DCMC921T350EH2B	161.7	3.3	1 3/4 x 2 5/8
990	DCMC991T350BA2B	167.6	3.3	2 x 2 1/8
1000	DCMC102T350AC2B	127.5	4.0	1 3/8 x 4 1/8
1200	DCMC122T350AD2B	109.6	3.5	1 3/8 x 4 5/8
1200	DCMC122T350EB2B	124.7	3.5	1 3/4 x 3 1/8
1200	DCMC122T350BH2B	132.2	3.6	2 x 2 5/8
1300	DCMC132T350AE2B	97.2	4.5	1 3/8 x 5 1/8
1500	DCMC152T350AF2B	85.9	5.0	1 3/8 x 5 5/8
1500	DCMC152T350EJ2B	97.3	4.9	1 3/4 x 3 5/8
1500	DCMC152T350BB2B	101.5	4.9	2 x 3 1/8
1800	DCMC182T350EC2B	79.9	5.8	1 3/4 x 4 1/8
1900	DCMC192T350BJ2B	79.2	4.4	2 x 3 5/8
2000	DCMC202T350CH2B	86.9	4.6	2 1/2 x 2 5/8
2100	DCMC212T350ED2B	67.8	5.5	1 3/4 x 4 5/8
2300	DCMC232T350BC2B	65.1	5.9	2 x 4 1/8
2400	DCMC242T350EE2B	59.1	6.5	1 3/4 x 5 1/8
2500	DCMC252T350CB2B	61.0	6.6	2 1/2 x 3 1/8
2700	DCMC272T350EF2B	52.4	7.4	1 3/4 x 5 5/8
2700	DCMC272T350BD2B	55.4	7.5	2 x 4 5/8
3100	DCMC312T350BE2B	48.7	7.0	2 x 5 1/8
3100	DCMC312T350CJ2B	48.5	7.5	2 1/2 x 3 5/8
3500	DCMC352T350BF2B	42.8	8.3	2 x 5 5/8
3700	DCMC372T350CC2B	39.9	9.0	2 1/2 x 4 1/8
3800	DCMC382T350DB2B	54.0	8.1	3 x 3 1/8
4200	DCMC422T350CD2B	34.0	10.5	2 1/2 x 4 5/8
4600	DCMC462T350DJ2B	41.7	9.8	3 x 3 5/8
4800	DCMC482T350CE2B	29.6	10.7	2 1/2 x 5 1/8
5400	DCMC542T350CF2B	26.2	11.9	2 1/2 x 5 5/8
5500	DCMC552T350DC2B	34.7	10.8	3 x 4 1/8
6300	DCMC632T350DD2B	29.6	12.2	3 x 4 5/8

# Type DCMC 85 °C High Capacitance, Screw Terminal, Aluminum

## Highest Capacitance Screw Terminal Type

Cap. (µF)	Catalog Part Number	ESR Max. @ 25 °C 120 Hz (mΩ)	Ripple Max. @ 85°C 120 Hz (A)	Nominal Size D x L (inches)	Cap. (µF)	Catalog Part Number	ESR Max. @ 25 °C 120 Hz (mΩ)	Ripple Max. @ 85°C 120 Hz (A)	Nominal Size D x L (inches)
7200	DCMC722T350DE2B	25.8	13.4	3 x 5 1/8	5300	DCMC532T400DD2B	31.5	11.8	3 x 4 5/8
7700	DCMC772T350FC2D	29.9	12.8	3 1/2 x 4 1/8	6000	DCMC602T400DE2B	27.4	13.0	3 x 5 1/8
8200	DCMC822T350DF2B	22.9	14.9	3 x 5 5/8	6400	DCMC642T400FC2D	31.9	12.4	3 1/2 x 4 1/8
8400	DCMC842T350DP2B	21.7	17.2	3 x 5 7/8	6800	DCMC682T400DF2B	24.4	14.4	3 x 5 5/8
8800	DCMC882T350FD2D	25.7	13.8	3 1/2 x 4 5/8	7100	DCMC712T400DP2B	23.1	16.7	3 x 5 7/8
10000	DCMC103T350FE2D	22.5	15.3	3 1/2 x 5 1/8	7400	DCMC742T400FD2D	27.4	13.4	3 1/2 x 4 5/8
11000	DCMC113T350DN2B	17.1	19.1	3 x 7 5/8	8400	DCMC842T400FE2D	23.9	14.8	3 1/2 x 5 1/8
11000	DCMC113T350FF2D	20.0	16.7	3 1/2 x 5 5/8	9400	DCMC942T400FF2D	21.2	16.2	3 1/2 x 5 5/8
12000	DCMC123T350FP2D	18.9	17.7	3 1/2 x 5 7/8	9600	DCMC962T400DN2B	18.2	18.6	3 x 7 5/8
13000	DCMC133T350DG2B	14.2	20.7	3 x 8 5/8	9900	DCMC992T400FP2D	20.1	17.2	3 1/2 x 5 7/8
16000	DCMC163T350FN2D	14.9	22.3	3 1/2 x 7 5/8	11000	DCMC113T400DG2B	15.1	20.1	3 x 8 5/8
18000	DCMC183T350FG2D	12.4	24.8	3 1/2 x 8 5/8	13000	DCMC133T400FN2D	15.8	21.7	3 1/2 x 7 5/8
<b>400 Vdc (450 Vdc Surge)</b>					<b>450 Vdc (500 Vdc Surge)</b>				
180	DCMC181T400AK2B	652.4	1.1	1 3/8 x 1 5/8	150	DCMC151T450AK2B	796.7	1.0	1 3/8 x 1 5/8
350	DCMC351T400AA2B	408.2	1.6	1 3/8 x 2 1/8	270	DCMC271T450AA2B	437.7	1.5	1 3/8 x 2 1/8
420	DCMC421T400AH2B	272.6	2.1	1 3/8 x 2 5/8	350	DCMC351T450AH2B	337.1	1.8	1 3/8 x 2 5/8
570	DCMC571T400AB2B	204.8	2.5	1 3/8 x 3 1/8	460	DCMC461T450EA2B	264.2	2.2	1 3/4 x 2 1/8
630	DCMC631T400EA2B	189.5	2.8	1 3/4 x 2 1/8	470	DCMC471T450AB2B	253.2	2.4	1 3/8 x 3 1/8
710	DCMC711T400AJ2B	164.3	3.1	1 3/8 x 3 5/8	560	DCMC561T450AJ2B	203.0	2.8	1 3/8 x 3 5/8
760	DCMC761T400EH2B	173.7	3.2	1 3/4 x 2 5/8	570	DCMC571T450EH2B	213.1	2.9	1 3/4 x 2 5/8
820	DCMC821T400BA2B	179.3	3.2	2 x 2 1/8	590	DCMC591T450BA2B	228.4	2.9	2 x 2 1/8
850	DCMC851T400AC2B	137.3	3.8	1 3/8 x 4 1/8	680	DCMC681T450AC2B	169.5	3.4	1 3/8 x 4 1/8
1000	DCMC102T400AD2B	118.0	3.4	1 3/8 x 4 5/8	740	DCMC741T450EB2B	164.5	2.8	1 3/4 x 3 1/8
1000	DCMC102T400EB2B	134.0	3.4	1 3/4 x 3 1/8	780	DCMC781T450BH2B	178.0	2.9	2 x 2 5/8
1000	DCMC102T400BH2B	141.7	3.5	2 x 2 5/8	820	DCMC821T450AD2B	145.6	3.5	1 3/8 x 4 5/8
1100	DCMC112T400AE2B	104.6	4.3	1 3/8 x 5 1/8	920	DCMC921T450EJ2B	130.9	3.8	1 3/4 x 3 5/8
1200	DCMC122T400AF2B	92.4	4.8	1 3/8 x 5 5/8	930	DCMC931T450AE2B	127.7	4.1	1 3/8 x 5 1/8
1200	DCMC122T400EJ2B	106.6	4.6	1 3/4 x 3 5/8	1000	DCMC102T450AF2B	113.9	4.5	1 3/8 x 5 5/8
1300	DCMC132T400BB2B	108.9	4.8	2 x 3 1/8	1000	DCMC102T450BB2B	137.0	4.3	2 x 3 1/8
1500	DCMC152T400EC2B	85.8	5.6	1 3/4 x 4 1/8	1100	DCMC112T450EC2B	107.4	5.0	1 3/4 x 4 1/8
1600	DCMC162T400BJ2B	85.0	4.3	2 x 3 5/8	1200	DCMC122T450BJ2B	109.0	3.8	2 x 3 5/8
1700	DCMC172T400ED2B	74.3	4.9	1 3/4 x 4 5/8	1200	DCMC122T450CH2B	115.8	4.0	2 1/2 x 2 5/8
1700	DCMC172T400CH2B	93.1	4.7	2 1/2 x 2 5/8	1300	DCMC132T450ED2B	91.1	4.7	1 3/4 x 4 5/8
1900	DCMC192T400BC2B	69.8	5.7	2 x 4 1/8	1500	DCMC152T450EE2B	79.2	5.4	1 3/4 x 5 1/8
2000	DCMC202T400EE2B	63.4	6.3	1 3/4 x 5 1/8	1500	DCMC152T450BC2B	89.5	5.3	2 x 4 1/8
2100	DCMC212T400CB2B	65.3	6.4	2 1/2 x 3 1/8	1700	DCMC172T450EF2B	70.2	6.2	1 3/4 x 5 5/8
2200	DCMC222T400EF2B	57.3	7.1	1 3/4 x 5 5/8	1700	DCMC172T450CB2B	81.1	6.0	2 1/2 x 3 1/8
2300	DCMC232T400BD2B	59.3	7.2	2 x 4 5/8	1800	DCMC182T450BD2B	76.0	6.4	2 x 4 5/8
2600	DCMC262T400BE2B	52.2	6.8	2 x 5 1/8	1900	DCMC192T450BE2B	66.8	6.0	2 x 5 1/8
2600	DCMC262T400CJ2B	52.0	7.2	2 1/2 x 3 5/8	2000	DCMC202T450CJ2B	66.5	6.4	2 1/2 x 3 5/8
2900	DCMC292T400BF2B	45.9	8.1	2 x 5 5/8	2200	DCMC222T450BF2B	58.6	7.1	2 x 5 5/8
3100	DCMC312T400CC2B	42.8	8.7	2 1/2 x 4 1/8	2400	DCMC242T450CC2B	54.7	7.7	2 1/2 x 4 1/8
3200	DCMC322T400DB2B	57.5	7.8	3 x 3 1/8	2500	DCMC252T450DB2B	65.7	7.3	3 x 3 1/8
3900	DCMC392T400CD2B	35.6	10.3	2 1/2 x 4 5/8	2800	DCMC282T450CD2B	46.4	9.0	2 1/2 x 4 5/8
3900	DCMC392T400DJ2B	44.9	9.4	3 x 3 5/8	3000	DCMC302T450DJ2B	52.2	8.7	3 x 3 5/8
4000	DCMC402T400CE2B	31.7	10.3	2 1/2 x 5 1/8	3300	DCMC332T450CE2B	40.4	9.2	2 1/2 x 5 1/8
4700	DCMC472T400CF2B	28.1	11.5	2 1/2 x 5 5/8	3900	DCMC392T450CF2B	35.4	10.3	2 1/2 x 5 5/8
4700	DCMC472T400DC2B	37.0	10.5	3 x 4 1/8					

# Type DCMC 85 °C High Capacitance, Screw Terminal, Aluminum

## Highest Capacitance Screw Terminal Type

Cap. (µF)	Catalog Part Number	ESR Max. @ 25 °C 120 Hz (mΩ)	Ripple Max. @ 85°C 120 Hz (A)	Nominal Size D x L (inches)
3900	DCMC392T450DC2B	40.1	10.1	3 x 4 1/8
4100	DCMC412T450DD2B	37.5	10.8	3 x 4 5/8
4700	DCMC472T450DE2B	32.5	12.0	3 x 5 1/8
5000	DCMC502T450FC2D	31.8	12.5	3 1/2 x 4 1/8
5600	DCMC562T450DF2B	28.8	13.3	3 x 5 5/8
5800	DCMC582T450DP2B	27.3	15.4	3 x 5 7/8
5800	DCMC582T450FD2D	27.0	13.5	3 1/2 x 4 5/8
6800	DCMC682T450FE2D	23.5	15.0	3 1/2 x 5 1/8
7300	DCMC732T450FF2D	21.1	16.3	3 1/2 x 5 5/8
7700	DCMC772T450FP2D	20.0	17.2	3 1/2 x 5 7/8
7900	DCMC792T450DN2B	21.3	17.1	3 x 7 5/8
9000	DCMC902T450DG2B	17.6	18.6	3 x 8 5/8
10000	DCMC103T450FN2D	15.9	21.6	3 1/2 x 7 5/8
12000	DCMC123T450FG2D	13.3	24.0	3 1/2 x 8 5/8
<b>500 Vdc (550 Vdc Surge)</b>				
110	DCMC111T500AK2B	1224.3	0.8	1 3/8 x 1 5/8
180	DCMC181T500AA2B	736.9	1.2	1 3/8 x 2 1/8
240	DCMC241T500AH2B	556.5	1.4	1 3/8 x 2 5/8
270	DCMC271T500EA2B	498.4	1.6	1 3/4 x 2 1/8
320	DCMC321T500AB2B	409.7	1.9	1 3/8 x 3 1/8
340	DCMC341T500BA2B	393.1	2.0	2 x 2 1/8
380	DCMC381T500EH2B	347.2	2.2	1 3/4 x 2 5/8
400	DCMC401T500AJ2B	338.1	2.4	1 3/8 x 3 5/8
470	DCMC471T500BH2B	273.9	2.7	2 x 2 5/8
480	DCMC481T500AC2B	293.2	2.1	1 3/8 x 4 1/8
500	DCMC501T500EB2B	264.5	2.4	1 3/4 x 3 1/8
560	DCMC561T500AD2B	261.2	2.6	1 3/8 x 4 5/8
640	DCMC641T500AE2B	231.1	2.9	1 3/8 x 5 1/8
650	DCMC651T500EJ2B	202.0	3.2	1 3/4 x 3 5/8
700	DCMC701T500BB2B	200.1	3.4	2 x 3 1/8
720	DCMC721T500AF2B	195.4	3.6	1 3/8 x 5 5/8
790	DCMC791T500EC2B	172.4	3.9	1 3/4 x 4 1/8
800	DCMC801T500CH2B	170.6	3.0	2 1/2 x 2 5/8
860	DCMC861T500BJ2B	159.1	3.4	2 x 3 5/8
930	DCMC931T500ED2B	149.1	3.7	1 3/4 x 4 5/8
1000	DCMC102T500BC2B	138.7	4.1	2 x 4 1/8
1100	DCMC112T500EE2B	129.6	4.4	1 3/4 x 5 1/8

Cap. (µF)	Catalog Part Number	ESR Max. @ 25 °C 120 Hz (mΩ)	Ripple Max. @ 85°C 120 Hz (A)	Nominal Size D x L (inches)
1100	DCMC112T500CB2B	122.0	4.7	2 1/2 x 3 1/8
1200	DCMC122T500EF2B	114.7	5.0	1 3/4 x 5 5/8
1200	DCMC122T500BD2B	117.7	5.1	2 x 4 5/8
1400	DCMC142T500BE2B	102.3	4.8	2 x 5 1/8
1400	DCMC142T500CJ2B	95.1	5.3	2 1/2 x 3 5/8
1500	DCMC152T500BF2B	93.3	5.7	2 x 5 5/8
1700	DCMC172T500CC2B	79.7	6.4	2 1/2 x 4 1/8
1700	DCMC172T500DB2B	86.4	6.4	3 x 3 1/8
2100	DCMC212T500CE2B	61.1	7.8	2 1/2 x 5 1/8
2200	DCMC222T500CD2B	68.3	7.6	2 1/2 x 4 5/8
2200	DCMC222T500DJ2B	67.4	7.1	3 x 3 5/8
2500	DCMC252T500CF2B	54.7	8.3	2 1/2 x 5 5/8
2500	DCMC252T500DC2B	55.4	8.6	3 x 4 1/8
3000	DCMC302T500DD2B	48.1	9.5	3 x 4 5/8
3400	DCMC342T500DE2B	43.1	10.4	3 x 5 1/8
3500	DCMC352T500FC2D	40.1	11.1	3 1/2 x 4 1/8
3900	DCMC392T500DF2B	37.5	11.6	3 x 5 5/8
4100	DCMC412T500DP2B	35.5	13.5	3 x 5 7/8
4100	DCMC412T500FD2D	34.1	12.0	3 1/2 x 4 5/8
4800	DCMC482T500FE2D	30.0	13.2	3 1/2 x 5 1/8
5400	DCMC542T500FF2D	28.0	14.2	3 1/2 x 5 5/8
5700	DCMC572T500FP2D	26.0	15.1	3 1/2 x 5 7/8
5700	DCMC572T500DN2B	27.9	15.0	3 x 7 5/8
6600	DCMC662T500DG2B	23.1	16.2	3 x 8 5/8
7900	DCMC792T500FN2D	20.5	19.1	3 1/2 x 7 5/8
9200	DCMC922T500FG2D	16.7	21.4	3 1/2 x 8 5/8
<b>550 Vdc (600 Vdc Surge)</b>				
1400	DCMC142T550CC2B	170.5	4.9	2 1/2 x 4 1/8
1700	DCMC172T550CD2B	132.6	5.9	2 1/2 x 4 5/8
1900	DCMC192T550CE2B	111.7	6.8	2 1/2 x 5 1/8
2200	DCMC222T550DC2B	90.4	7.8	3 x 4 1/8
2300	DCMC232T550CF2B	86.5	7.8	2 1/2 x 5 5/8
2500	DCMC252T550DD2B	79.6	8.4	3 x 4 5/8
2900	DCMC292T550DE2B	64.0	9.7	3 x 5 1/8
3400	DCMC342T550DF2B	54.6	10.9	3 x 5 5/8
3700	DCMC372T550DP2B	50.2	12.2	3 x 5 7/8
5100	DCMC512T550DN2B	36.4	16.2	3 x 7 5/8

# Type DCMC 85 °C High Capacitance, Screw Terminal, Aluminum

## Highest Capacitance Screw Terminal Type

### Typical Performance Curves

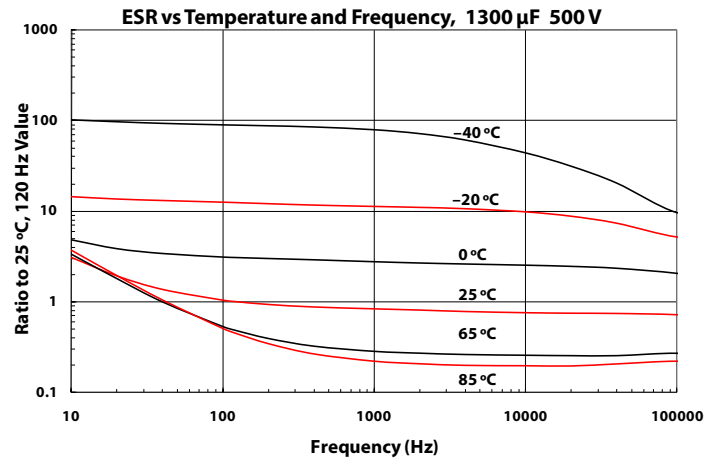
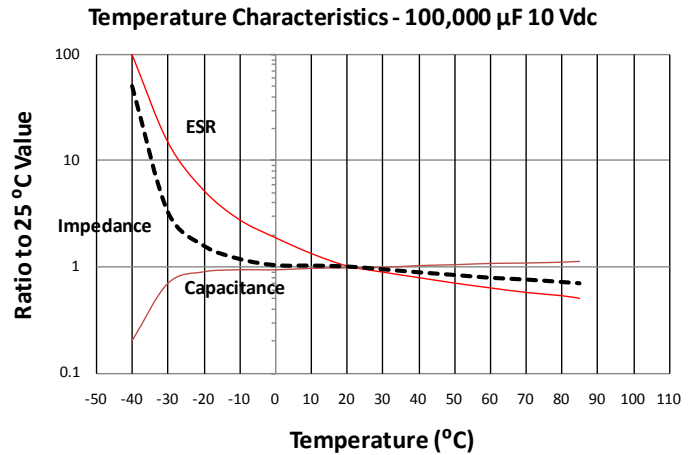
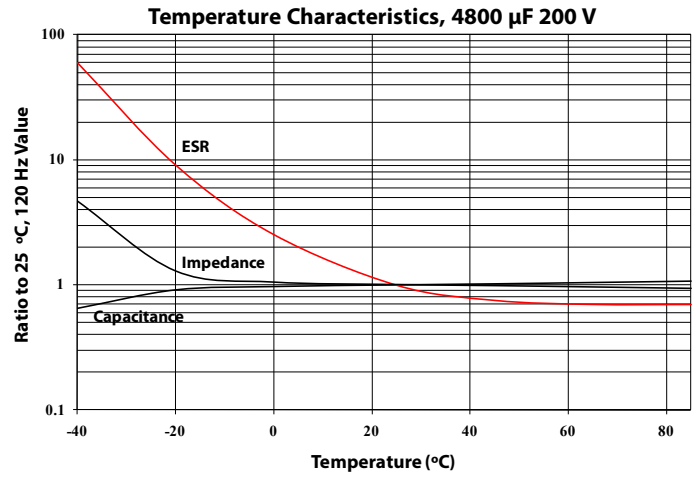
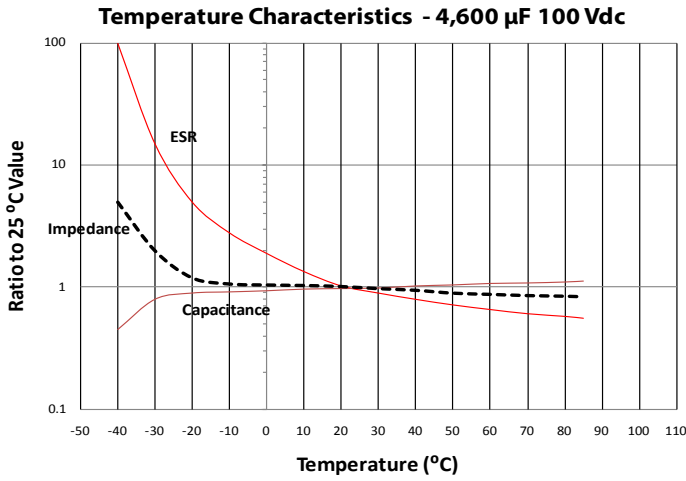

# Type DCMC 85 °C High Capacitance, Screw Terminal, Aluminum

## Highest Capacitance Screw Terminal Type

### Typical Performance Curves

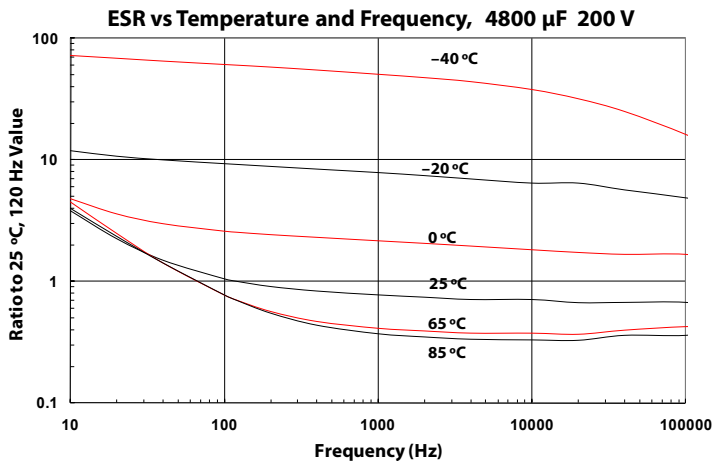
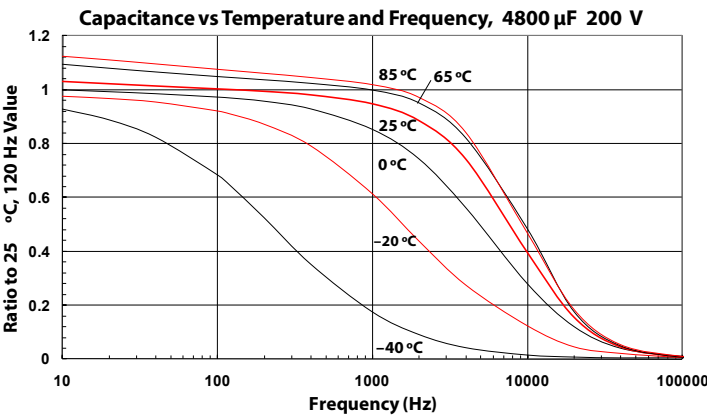
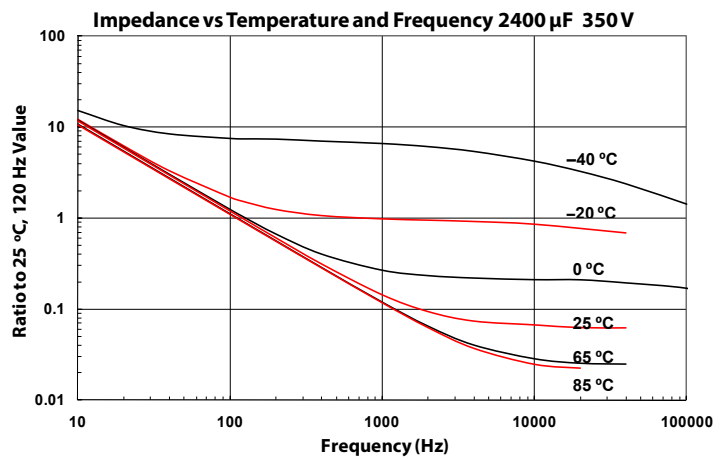
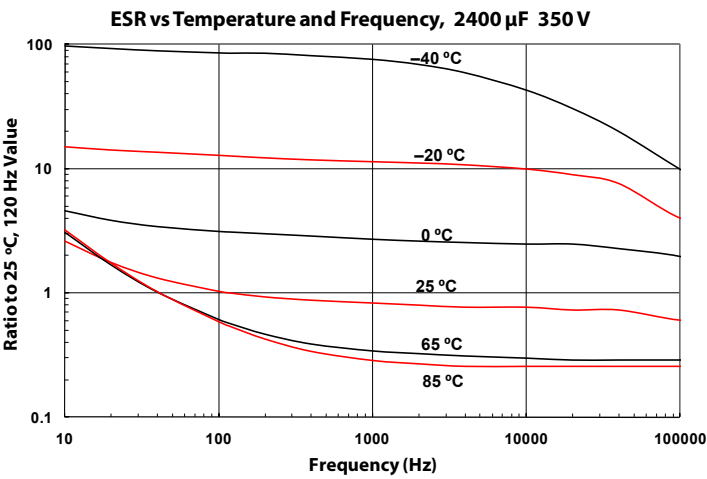
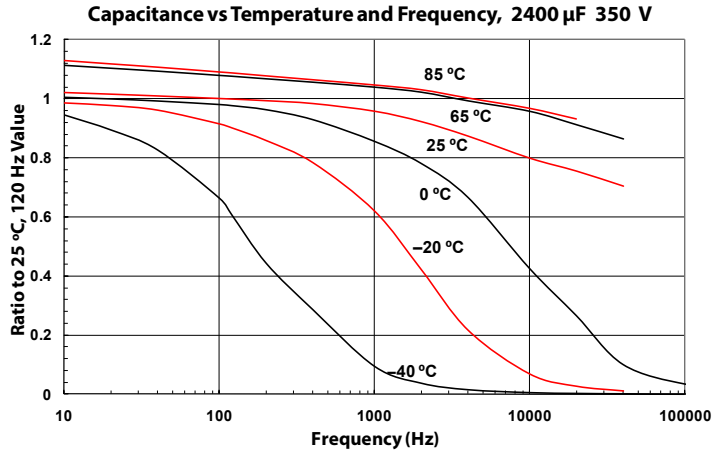
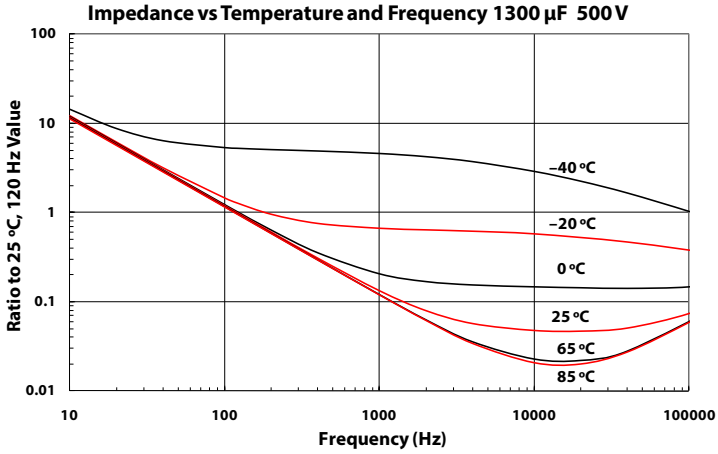

# Type DCMC 85 °C High Capacitance, Screw Terminal, Aluminum

## Highest Capacitance Screw Terminal Type

### Typical Performance Curves



**Notice and Disclaimer:** All product drawings, descriptions, specifications, statements, information and data (collectively, the "Information") in this datasheet or other publication are subject to change. The customer is responsible for checking, confirming and verifying the extent to which the Information contained in this datasheet or other publication is applicable to an order at the time the order is placed. All Information given herein is believed to be accurate and reliable, but it is presented without any guarantee, warranty, representation or responsibility of any kind, expressed or implied. Statements of suitability for certain applications are based on the knowledge that the Cornell Dubilier company providing such statements ("Cornell Dubilier") has of operating conditions that such Cornell Dubilier company regards as typical for such applications, but are not intended to constitute any guarantee, warranty or representation regarding any such matter – and Cornell Dubilier specifically and expressly disclaims any guarantee, warranty or representation concerning the suitability for a specific customer application, use, storage, transportation, or operating environment. The Information is intended for use only by customers who have the requisite experience and capability to determine the correct products for their application. Any technical advice inferred from this Information or otherwise provided by Cornell Dubilier with reference to the use of any Cornell Dubilier products is given gratis (unless otherwise specified by Cornell Dubilier), and Cornell Dubilier assumes no obligation or liability for the advice given or results obtained. Although Cornell Dubilier strives to apply the most stringent quality and safety standards regarding the design and manufacturing of its products, in light of the current state of the art, isolated component failures may still occur. Accordingly, customer applications which require a high degree of reliability or safety should employ suitable designs or other safeguards (such as installation of protective circuitry or redundancies or other appropriate protective measures) in order to ensure that the failure of an electrical component does not result in a risk of personal injury or property damage. Although all product-related warnings, cautions and notes must be observed, the customer should not assume that all safety measures are indicated in such warnings, cautions and notes, or that other safety measures may not be required.



Компания «Океан Электроники» предлагает заключение долгосрочных отношений при поставках импортных электронных компонентов на взаимовыгодных условиях!

Наши преимущества:

- Поставка оригинальных импортных электронных компонентов напрямую с производств Америки, Европы и Азии, а так же с крупнейших складов мира;
- Широкая линейка поставок активных и пассивных импортных электронных компонентов (более 30 млн. наименований);
- Поставка сложных, дефицитных, либо снятых с производства позиций;
- Оперативные сроки поставки под заказ (от 5 рабочих дней);
- Экспресс доставка в любую точку России;
- Помощь Конструкторского Отдела и консультации квалифицированных инженеров;
- Техническая поддержка проекта, помощь в подборе аналогов, поставка прототипов;
- Поставка электронных компонентов под контролем ВП;
- Система менеджмента качества сертифицирована по Международному стандарту ISO 9001;
- При необходимости вся продукция военного и аэрокосмического назначения проходит испытания и сертификацию в лаборатории (по согласованию с заказчиком);
- Поставка специализированных компонентов военного и аэрокосмического уровня качества (Xilinx, Altera, Analog Devices, Intersil, Interpoint, Microsemi, Actel, Aeroflex, Peregrine, VPT, Syfer, Eurofarad, Texas Instruments, MS Kennedy, Miteq, Cobham, E2V, MA-COM, Hittite, Mini-Circuits, General Dynamics и др.);

Компания «Океан Электроники» является официальным дистрибьютором и эксклюзивным представителем в России одного из крупнейших производителей разъемов военного и аэрокосмического назначения «JONHON», а так же официальным дистрибьютором и эксклюзивным представителем в России производителя высокотехнологичных и надежных решений для передачи СВЧ сигналов «FORSTAR».



## JONHON

«JONHON» (основан в 1970 г.)

Разъемы специального, военного и аэрокосмического назначения:

(Применяются в военной, авиационной, аэрокосмической, морской, железнодорожной, горно- и нефтедобывающей отраслях промышленности)

«FORSTAR» (основан в 1998 г.)

ВЧ соединители, коаксиальные кабели, кабельные сборки и микроволновые компоненты:

(Применяются в телекоммуникациях гражданского и специального назначения, в средствах связи, РЛС, а так же военной, авиационной и аэрокосмической отраслях промышленности).



Телефон: 8 (812) 309-75-97 (многоканальный)

Факс: 8 (812) 320-03-32

Электронная почта: [ocean@oceanchips.ru](mailto:ocean@oceanchips.ru)

Web: <http://oceanchips.ru/>

Адрес: 198099, г. Санкт-Петербург, ул. Калинина, д. 2, корп. 4, лит. А