

3M™ Ultra Hard Metric (UHM) Press-Fit Socket

2 mm, D, DPWR, DE, E, FL & FR Types: 176, 200 or 88 Signal Contacts, 8 Rows, Right Angle

UHM Series

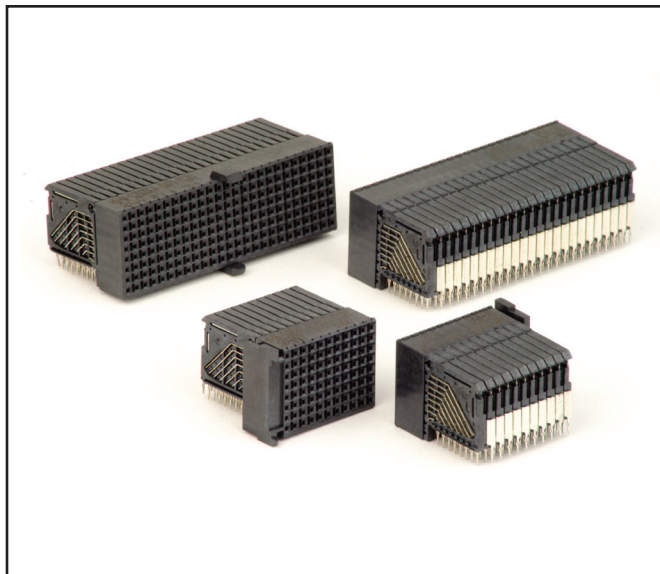

- 7+ Gbps data rates when mated to standard IEC 61076-4-101 headers.
- Low crosstalk at high frequencies
- 50/100 Ω (single-ended/differential) impedance
- Modular/scalable format IEC 61076-4-101
- Press-fit headers and receptacles
- 101 mated lines per linear inch
- Dual beam contact construction for high reliability
- End-to-end stackable with 8-Row 3M™ CP2, HM, UHM and HSHM Sockets
- Mates with 3M™ CP2, HM, UHM, HSHM Headers
- See the Regulatory Information Appendix (RIA) in the “RoHS compliance” section of www.3Mconnector.com for compliance information (RIA E1 & C1 apply)

Date Modified: February 15, 2010

TS-2326-B
Sheet 1 of 5

Physical

Insulation:

Material: High Temperature Thermoplastic (LCP) - black or natural
Flammability: UL 94V-0

Contact:

Material: Copper Alloy
Plating: See Ordering Information

Performance

Mechanical:

Normal Force (Nominal): 0.57 N [58 g] Signal, (0.74 N [75 g] Shield with HSHM & UHM headers)
Engagement Force (Nominal): 0.32 N [33 g] Signal, (0.22 N [22 g] Shield with HSHM & UHM headers)
Separation Force (Nominal): 0.20 N [20 g] Signal, (0.20 N [20 g] Shield with HSHM & UHM headers)
Wipe (Nominal, Shortest Contact): 2.67 mm [0.105 in] Signal, 1.57 mm [0.062 in] Shield
Application: These modules are not suitable for stand-alone use, additional guide features recommended per IEC 61076-4-101

Electrical:

Data Rate: 7+ Gbps data rates (when mated to standard IEC 61076-4-101 headers)
Characteristic Impedance: 50 Ω Single-ended, 100 Ω Differential
Current Rating (Fully Loaded): 1 A @ 70° C Signal
Insulation Resistance: 10⁴ M Ω @ 100 V_{DC}
Withstanding Voltage: 750 V_{RMS}

Environmental

Temperature Rating: -55° C to 125° C

UL File No.: E68080

3M
Electronic Solutions Division
Interconnect Solutions
<http://www.3Mconnector.com>

3M is a trademark of 3M Company.
For technical, sales or ordering information call
800-225-5373

3M™ Ultra Hard Metric (UHM) Press-Fit Socket

2 mm, D, DPWR, DE, E, FL & FR Types: 176, 200 or 88 Signal Contacts, 8 Rows, Right Angle

UHM Series

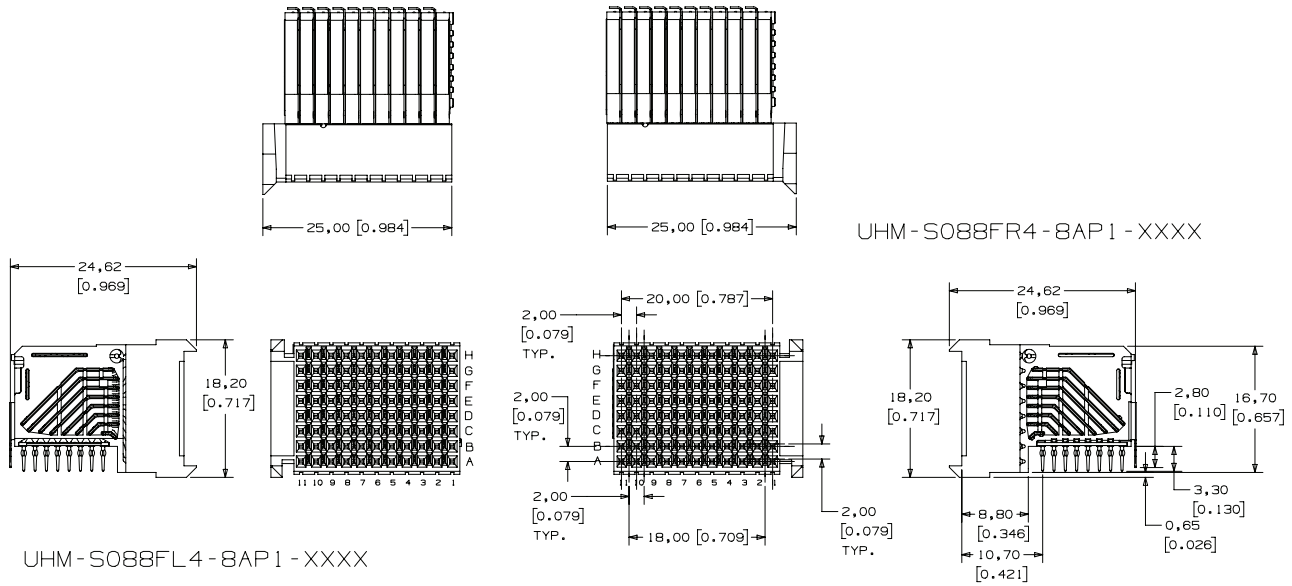

UHM-S088FL4-8AP1-XXXX

UHM-S088FR4-8AP1-XXXX

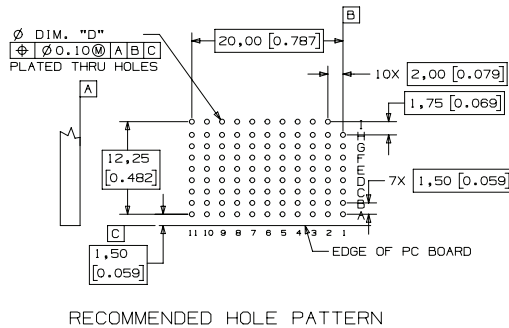

mm [Inch]			
Tolerance Unless Noted			
0.	.0	.00	
mm	1	0.3	0.13

[] Dimensions used for Reference Only

Hole Plating Table mm [in.]			
Finished Hole Dia. (D)	Cu. Thickness	SnPb Thickness	Drilled Hole Dia.
0.550 - 0.650 [.0217 - .0256]	0.025 - 0.045 [.0010 - .0018]	0.008 - 0.018 [.0003 - .0007]	0.686 - 0.727 [.0270 - .0286]

Ordering Information

UHM-SXXXXX4-8AP1-XXXX

Number of Signal Contacts & Body Style: _____
088FL, 088FR, 176D, 176DPWR, 200DE, 200E

High Speed Option: _____
4 = 50 Ohm Coaxial single-ended and
100 Ohm Differential pair
applications

Tail Length: _____
1 = 3.3 mm

Plating um [u"]:
TG30 = 0.76 [30] Min. Au Contact Area
2.54 [100] Min. SnPb Terminal Area
1.27 [50] Min. Ni All Over
(RIA E2 & C2 apply)

TS-2326-B
Sheet 2 of 5

3M™ Ultra Hard Metric (UHM) Press-Fit Socket

2 mm, D, DPWR, DE, E, FL & FR Types: 176, 200 or 88 Signal Contacts, 8 Rows, Right Angle

UHM Series

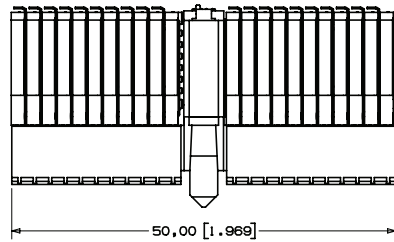

UHM-S176DPWR4-8AP1-XXXX

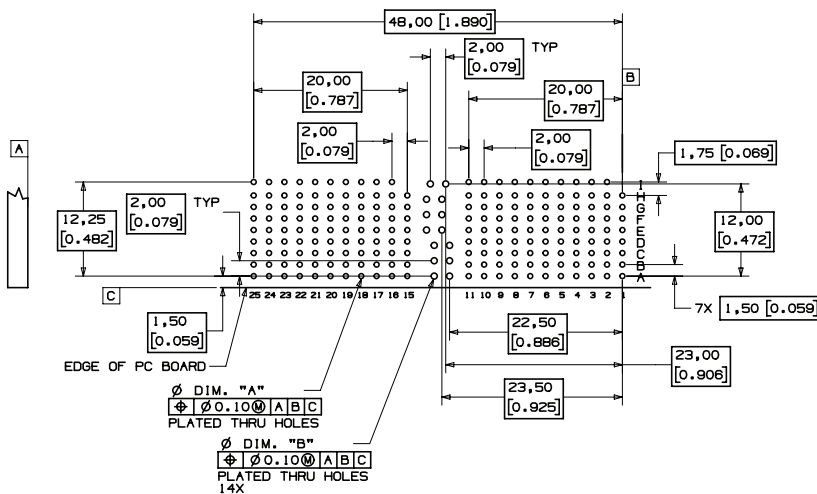
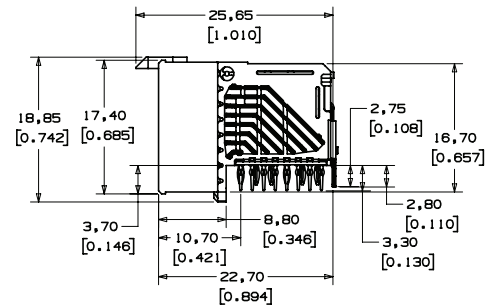
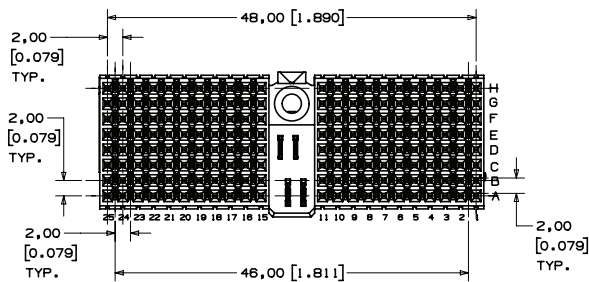

RECOMMENDED HOLE PATTERN

		mm [Inch]		
		Tolerance Unless Noted		
		0.	.0	.00
mm		1	0.3	0.13

[] Dimensions used for Reference Only

3M™ Ultra Hard Metric (UHM) Press-Fit Socket

2 mm, D, DPWR, DE, E, FL & FR Types: 176, 200 or 88 Signal Contacts, 8 Rows, Right Angle

UHM Series

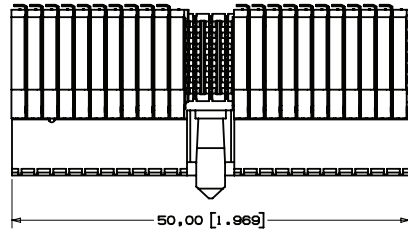

UHM-S176D4-8AP1-XXXX

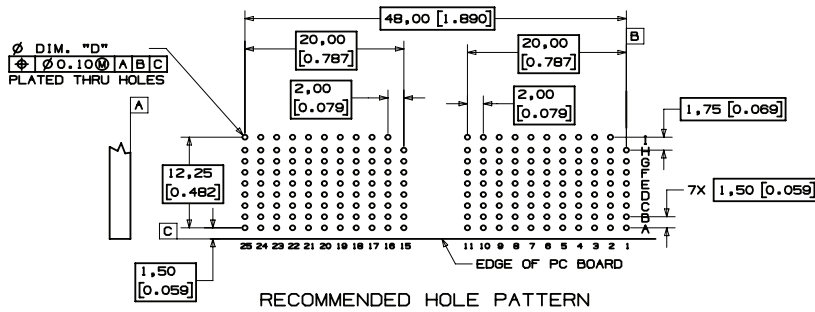
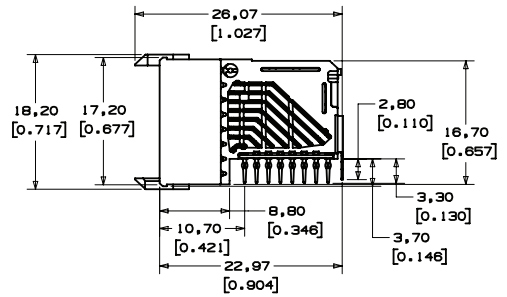
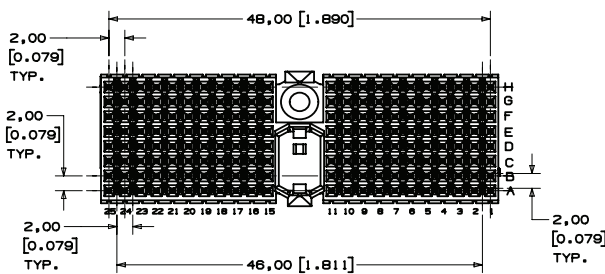

		mm [Inch]		
		Tolerance Unless Noted		
		0.	.0	.00
mm		1	0.3	0.13

[] Dimensions used for Reference Only

3M™ Ultra Hard Metric (UHM) Press-Fit Socket

2 mm, D, DPWR, DE, E, FL & FR Types: 176, 200 or 88 Signal Contacts, 8 Rows, Right Angle

UHM Series

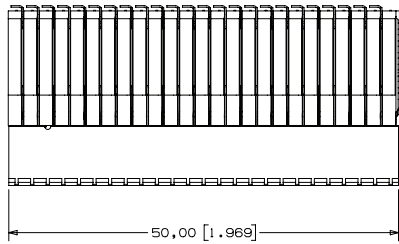

UHM-S200E4-8AP1-XXXX

mm [Inch]			
Tolerance Unless Noted			
0.	.0	.00	
mm	1	0.3	0.13

[] Dimensions used for Reference Only

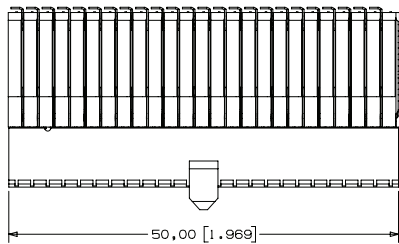
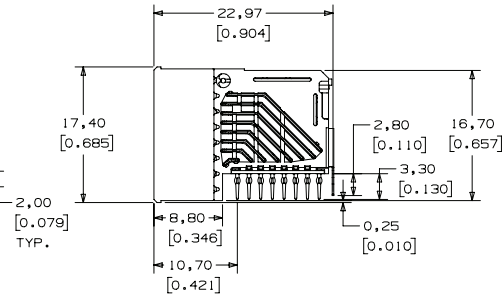
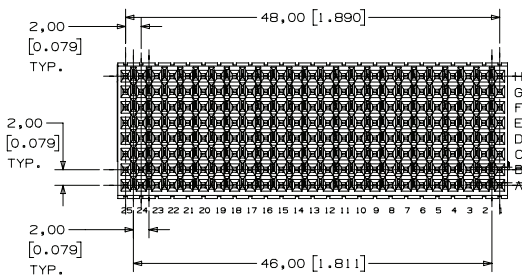

UHM-S200DE4-8AP1-XXXX

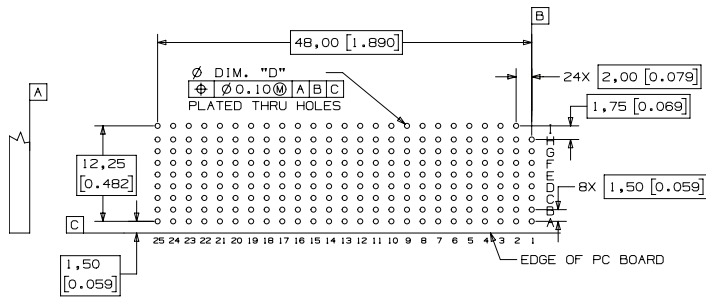
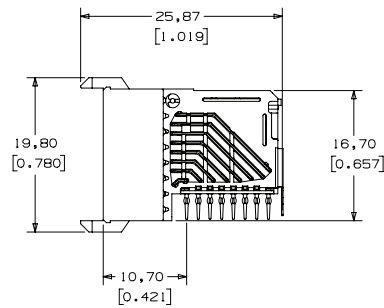
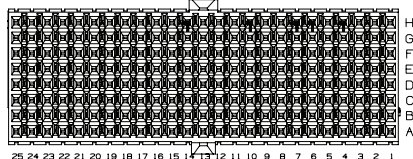

RECOMMENDED HOLE PATTERN

TS-2326-B
Sheet 5 of 5

Important Notice

All statements, technical information, and recommendations related to 3M's products are based on information believed to be reliable, but the accuracy or completeness is not guaranteed. Before using this product, you must evaluate it and determine if it is suitable for your intended application. You assume all risks and liability associated with such use. Any statements related to the product which are not contained in 3M's current publications, or any contrary statements contained on your purchase order shall have no force or effect unless expressly agreed upon, in writing, by an authorized officer of 3M.

Warranty; Limited Remedy; Limited Liability.

This product will be free from defects in material and manufacture for a period of one (1) year from the time of purchase. **3M MAKES NO OTHER WARRANTIES INCLUDING, BUT NOT LIMITED TO, ANY IMPLIED WARRANTY OF MERCHANTABILITY OR FITNESS FOR A PARTICULAR PURPOSE.** If this product is defective within the warranty period stated above, your exclusive remedy shall be, at 3M's option, to replace or repair the 3M product or refund the purchase price of the 3M product. **Except where prohibited by law, 3M will not be liable for any indirect, special, incidental or consequential loss or damage arising from this 3M product, regardless of the legal theory asserted.**

**3M Electronics Solutions Division**

6801 River Place Blvd.
Austin, TX 78726-9000
U.S.A.
1-800-225-5373
www.3Mconnector.com

Please recycle. Printed in USA.
© 3M 2010. All rights reserved.
RIA-2217B-E

3M is a trademark of 3M Company.

Компания «Океан Электроники» предлагает заключение долгосрочных отношений при поставках импортных электронных компонентов на взаимовыгодных условиях!

Наши преимущества:

- Поставка оригинальных импортных электронных компонентов напрямую с производств Америки, Европы и Азии, а так же с крупнейших складов мира;
- Широкая линейка поставок активных и пассивных импортных электронных компонентов (более 30 млн. наименований);
- Поставка сложных, дефицитных, либо снятых с производства позиций;
- Оперативные сроки поставки под заказ (от 5 рабочих дней);
- Экспресс доставка в любую точку России;
- Помощь Конструкторского Отдела и консультации квалифицированных инженеров;
- Техническая поддержка проекта, помощь в подборе аналогов, поставка прототипов;
- Поставка электронных компонентов под контролем ВП;
- Система менеджмента качества сертифицирована по Международному стандарту ISO 9001;
- При необходимости вся продукция военного и аэрокосмического назначения проходит испытания и сертификацию в лаборатории (по согласованию с заказчиком);
- Поставка специализированных компонентов военного и аэрокосмического уровня качества (Xilinx, Altera, Analog Devices, Intersil, Interpoint, Microsemi, Actel, Aeroflex, Peregrine, VPT, Syfer, Eurofarad, Texas Instruments, MS Kennedy, Miteq, Cobham, E2V, MA-COM, Hittite, Mini-Circuits, General Dynamics и др.);

Компания «Океан Электроники» является официальным дистрибьютором и эксклюзивным представителем в России одного из крупнейших производителей разъемов военного и аэрокосмического назначения «**JONHON**», а так же официальным дистрибьютором и эксклюзивным представителем в России производителя высокотехнологичных и надежных решений для передачи СВЧ сигналов «**FORSTAR**».



JONHON

«**JONHON**» (основан в 1970 г.)

Разъемы специального, военного и аэрокосмического назначения:

(Применяются в военной, авиационной, аэрокосмической, морской, железнодорожной, горно- и нефтедобывающей отраслях промышленности)

«**FORSTAR**» (основан в 1998 г.)

ВЧ соединители, коаксиальные кабели,
кабельные сборки и микроволновые компоненты:

(Применяются в телекоммуникациях гражданского и специального назначения, в средствах связи, РЛС, а так же военной, авиационной и аэрокосмической отраслях промышленности).



Телефон: 8 (812) 309-75-97 (многоканальный)

Факс: 8 (812) 320-03-32

Электронная почта: ocean@oceanchips.ru

Web: <http://oceanchips.ru/>

Адрес: 198099, г. Санкт-Петербург, ул. Калинина, д. 2, корп. 4, лит. А