



**Please note that Cypress is an Infineon Technologies Company.**

The document following this cover page is marked as “Cypress” document as this is the company that originally developed the product. Please note that Infineon will continue to offer the product to new and existing customers as part of the Infineon product portfolio.

**Continuity of document content**

The fact that Infineon offers the following product as part of the Infineon product portfolio does not lead to any changes to this document. Future revisions will occur when appropriate, and any changes will be set out on the document history page.

**Continuity of ordering part numbers**

Infineon continues to support existing part numbers. Please continue to use the ordering part numbers listed in the datasheet for ordering.

## New 8FX 8-bit Microcontrollers

The MB95560H/570H/580H is a series of general-purpose, single-chip microcontrollers. In addition to a compact instruction set, the microcontrollers of this series contain a variety of peripheral resources.

### Features

- F<sup>2</sup>MC-8FX CPU core
  - Instruction set optimized for controllers
    - Multiplication and division instructions
    - 16-bit arithmetic operations
    - Bit test branch instructions
    - Bit manipulation instructions, etc.
- Clock (The main oscillation clock and the suboscillation clock are only available on MB95F562H/F562K/F563H/F563K/F564H/F564K/F582H/F582K/F583H/F583K/F584H/F584K.)
  - Selectable main clock source
    - Main oscillation clock (up to 16.25 MHz, maximum machine clock frequency: 8.125 MHz)
    - External clock (up to 32.5 MHz, maximum machine clock frequency: 16.25 MHz)
    - Main CR clock (4 MHz ± 2%)
      - The main CR clock frequency becomes 8 MHz when the PLL multiplication rate is 2.
      - The main CR clock frequency becomes 10 MHz when the PLL multiplication rate is 2.5.
      - The main CR clock frequency becomes 12 MHz when the PLL multiplication rate is 3.
      - The main CR clock frequency becomes 16 MHz when the PLL multiplication rate is 4.
  - Selectable subclock source
    - Suboscillation clock (32.768 kHz)
    - External clock (32.768 kHz)
    - Sub-CR clock (Typ: 100 kHz, Min: 50 kHz, Max: 150 kHz)
- Timer
  - 8/16-bit composite timer × 2 channels (only one channel on MB95F572H/F572K/F573H/F573K/F574H/F574K/F582H/F582K/F583H/F583K/F584H/F584K)
  - Time-base timer × 1 channel
  - Watch prescaler × 1 channel
- LIN-UART (only available on MB95F562H/F562K/F563H/F563K/F564H/F564K/F582H/F582K/F583H/F583K/F584H/F584K)
  - Full duplex double buffer
  - Capable of clock synchronous serial data transfer and clock asynchronous serial data transfer
- External interrupt
  - Interrupt by edge detection (rising edge, falling edge, and both edges can be selected)
  - Can be used to wake up the device from different low power consumption (standby) modes
- 8/10-bit A/D converter
  - 8-bit or 10-bit resolution can be selected.
- Low power consumption (standby) modes
  - There are four standby modes as follows:
    - Stop mode
    - Sleep mode
    - Watch mode
    - Time-base timer mode
  - In standby mode, the device can be made to enter either normal standby mode or deep standby mode.
- I/O port
  - MB95F562H/F563H/F564H (maximum no. of I/O ports: 16)
    - General-purpose I/O ports (CMOS I/O): 15
    - General-purpose I/O ports (N-ch open drain): 1
  - MB95F562K/F563K/F564K (maximum no. of I/O ports: 17)
    - General-purpose I/O ports (CMOS I/O): 15
    - General-purpose I/O ports (N-ch open drain): 2
  - MB95F572H/F573H/F574H (maximum no. of I/O ports: 4)
    - General-purpose I/O ports (CMOS I/O): 3
    - General-purpose I/O ports (N-ch open drain): 1
  - MB95F572K/F573K/F574K (maximum no. of I/O ports: 5)
    - General-purpose I/O ports (CMOS I/O): 3
    - General-purpose I/O ports (N-ch open drain): 2
  - MB95F582H/F583H/F584H (maximum no. of I/O ports: 12)
    - General-purpose I/O ports (CMOS I/O): 11
    - General-purpose I/O ports (N-ch open drain): 1
  - MB95F582K/F583K/F584K (maximum no. of I/O ports: 13)
    - General-purpose I/O ports (CMOS I/O): 11
    - General-purpose I/O ports (N-ch open drain): 2
- On-chip debug
  - 1-wire serial control
  - Serial writing supported (asynchronous mode)
- Hardware/software watchdog timer
  - Built-in hardware watchdog timer
  - Built-in software watchdog timer
- Power-on reset
  - A power-on reset is generated when the power is switched on.
- Low-voltage detection reset circuit (only available on MB95F562K/F563K/F564K/F572K/F573K/F574K/F582K/F583K/F584K)
  - Built-in low-voltage detector
- Clock supervisor counter
  - Built-in clock supervisor counter function
- Dual operation Flash memory
  - The program/erase operation and the read operation can be executed in different banks (upper bank/lower bank) simultaneously.
- Flash memory security function
  - Protects the content of the Flash memory.

**Contents**

<b>Features</b> .....	<b>1</b>	<b>19. I/O Map (MB95570H Series)</b> .....	<b>34</b>
<b>1. Product Line-up</b> .....	<b>3</b>	<b>20. I/O Map (MB95580H Series)</b> .....	<b>37</b>
<b>2. Packages And Corresponding Products</b> .....	<b>7</b>	<b>21. Interrupt Source Table (MB95560H Series)</b> .....	<b>40</b>
<b>3. Differences Among Products And Notes On Product Selection</b> .....	<b>8</b>	<b>22. Interrupt Source Table (MB95570H Series)</b> .....	<b>41</b>
<b>4. Pin Assignment</b> .....	<b>9</b>	<b>23. Interrupt Source Table (MB95580H Series)</b> .....	<b>42</b>
<b>5. Pin Functions (MB95560H Series, 32 pins)</b> .....	<b>11</b>	<b>24. Electrical Characteristics</b> .....	<b>43</b>
<b>6. Pin Functions (MB95560H Series, 20 pins)</b> .....	<b>13</b>	24.1 Absolute Maximum Ratings.....	43
<b>7. Pin Functions (MB95570H Series, 8 pins)</b> .....	<b>15</b>	24.2 Recommended Operating Conditions .....	45
<b>8. Pin Functions (MB95580H Series, 32 pins)</b> .....	<b>16</b>	24.3 DC Characteristics .....	46
<b>9. Pin Functions (MB95580H Series, 16 pins)</b> .....	<b>18</b>	24.4 AC Characteristics.....	49
<b>10. I/O Circuit Type</b> .....	<b>20</b>	24.5 A/D Converter.....	63
<b>11. Handling Precautions</b> .....	<b>21</b>	24.6 Flash Memory Program/Erase Characteristics..	67
11.1 Precautions for Product Design.....	21	<b>25. Sample Characteristics</b> .....	<b>68</b>
11.2 Precautions for Package Mounting .....	23	<b>26. Mask Options</b> .....	<b>74</b>
11.3 Precautions for Use Environment.....	24	<b>27. Ordering Information</b> .....	<b>75</b>
<b>12. Notes On Device Handling</b> .....	<b>24</b>	<b>28. Package Dimension</b> .....	<b>77</b>
<b>13. Pin Connection</b> .....	<b>25</b>	<b>29. Major Changes In This Edition</b> .....	<b>84</b>
<b>14. Block Diagram (MB95560H Series)</b> .....	<b>26</b>	<b>Document History Page</b> .....	<b>87</b>
<b>15. Block Diagram (MB95570H Series)</b> .....	<b>27</b>	<b>Sales, Solutions, and Legal Information</b> .....	<b>88</b>
<b>16. Block Diagram (MB95580H Series)</b> .....	<b>28</b>	Worldwide Sales and Design Support .....	88
<b>17. CPU Core</b> .....	<b>29</b>	Products .....	88
<b>18. I/O Map (MB95560H Series)</b> .....	<b>30</b>	PSoC® Solutions .....	88
		Cypress Developer Community .....	88
		Technical Support .....	88



## 1. Product Line-up

• MB95560H Series

Part number	MB95F562H	MB95F563H	MB95F564H	MB95F562K	MB95F563K	MB95F564K
Parameter						
Type	Flash memory product					
Clock supervisor counter	It supervises the main clock oscillation.					
Flash memory capacity	8 Kbyte	12 Kbyte	20 Kbyte	8 Kbyte	12 Kbyte	20 Kbyte
RAM capacity	240 bytes	496 bytes	496 bytes	240 bytes	496 bytes	496 bytes
Power-on reset	Yes					
Low-voltage detection reset	No			Yes		
Reset input	Dedicated			Selected through software		
CPU functions	<ul style="list-style-type: none"> <li>• Number of basic instructions : 136</li> <li>• Instruction bit length : 8 bits</li> <li>• Instruction length : 1 to 3 bytes</li> <li>• Data bit length : 1, 8 and 16 bits</li> <li>• Minimum instruction execution time : 61.5 ns (machine clock frequency = 16.25 MHz)</li> <li>• Interrupt processing time : 0.6 μs (machine clock frequency = 16.25 MHz)</li> </ul>					
General-purpose I/O	<ul style="list-style-type: none"> <li>• I/O ports (Max) : 16</li> <li>• CMOS I/O : 15</li> <li>• N-ch open drain: 1</li> </ul>			<ul style="list-style-type: none"> <li>• I/O ports (Max) : 17</li> <li>• CMOS I/O : 15</li> <li>• N-ch open drain: 2</li> </ul>		
Time-base timer	Interval time: 0.256 ms to 8.3 s (external clock frequency = 4 MHz)					
Hardware/software watchdog timer	<ul style="list-style-type: none"> <li>• Reset generation cycle Main oscillation clock at 10 MHz: 105 ms (Min)</li> <li>• The sub-CR clock can be used as the source clock of the hardware watchdog timer.</li> </ul>					
Wild register	It can be used to replace 3 bytes of data.					
LIN-UART	<ul style="list-style-type: none"> <li>• A wide range of communication speed can be selected by a dedicated reload timer.</li> <li>• It has a full duplex double buffer.</li> <li>• Both clock synchronous serial data transfer and clock asynchronous serial data transfer are enabled.</li> <li>• The LIN function can be used as a LIN master or a LIN slave.</li> </ul>					
8/10-bit A/D converter	6 channels 8-bit or 10-bit resolution can be selected.					
8/16-bit composite timer	2 channels <ul style="list-style-type: none"> <li>• The timer can be configured as an "8-bit timer × 2 channels" or a "16-bit timer × 1 channel".</li> <li>• It has the following functions: interval timer function, PWC function, PWM function and input capture function.</li> <li>• Count clock: it can be selected from internal clocks (7 types) and external clocks.</li> <li>• It can output square wave.</li> </ul>					
External interrupt	6 channels <ul style="list-style-type: none"> <li>• Interrupt by edge detection (The rising edge, falling edge, or both edges can be selected.)</li> <li>• It can be used to wake up the device from the standby mode.</li> </ul>					
On-chip debug	<ul style="list-style-type: none"> <li>• 1-wire serial control</li> <li>• It supports serial writing (asynchronous mode).</li> </ul>					

Part number	MB95F562H	MB95F563H	MB95F564H	MB95F562K	MB95F563K	MB95F564K
Parameter						
Watch prescaler	Eight different time intervals can be selected.					
Flash memory	<ul style="list-style-type: none"> <li>It supports automatic programming (Embedded Algorithm), and program/erase/erase-suspend/erase-resume commands.</li> <li>It has a flag indicating the completion of the operation of Embedded Algorithm.</li> <li>Flash security feature for protecting the content of the Flash memory</li> </ul>					
	Number of program/erase cycles		1000	10000	100000	
	Data retention time		20 years	10 years	5 years	
Standby mode	Sleep mode, stop mode, watch mode, time-base timer mode					
Package	WNP032 SOJ020 STG020					

## • MB95570H Series

Part number	MB95F572H	MB95F573H	MB95F574H	MB95F572K	MB95F573K	MB95F574K
Parameter						
Type	Flash memory product					
Clock supervisor counter	It supervises the main clock oscillation.					
Flash memory capacity	8 Kbyte	12 Kbyte	20 Kbyte	8 Kbyte	12 Kbyte	20 Kbyte
RAM capacity	240 bytes	496 bytes	496 bytes	240 bytes	496 bytes	496 bytes
Power-on reset	Yes					
Low-voltage detection reset	No			Yes		
Reset input	Dedicated			Selected through software		
CPU functions	<ul style="list-style-type: none"> <li>Number of basic instructions : 136</li> <li>Instruction bit length : 8 bits</li> <li>Instruction length : 1 to 3 bytes</li> <li>Data bit length : 1, 8 and 16 bits</li> <li>Minimum instruction execution time : 61.5 ns (machine clock frequency = 16.25 MHz)</li> <li>Interrupt processing time : 0.6 μs (machine clock frequency = 16.25 MHz)</li> </ul>					
General-purpose I/O	<ul style="list-style-type: none"> <li>I/O ports (Max) : 4</li> <li>CMOS I/O : 3</li> <li>N-ch open drain: 1</li> </ul>			<ul style="list-style-type: none"> <li>I/O ports (Max) : 5</li> <li>CMOS I/O : 3</li> <li>N-ch open drain: 2</li> </ul>		
Time-base timer	Interval time: 0.256 ms to 8.3 s (external clock frequency = 4 MHz)					
Hardware/software watchdog timer	<ul style="list-style-type: none"> <li>Reset generation cycle Main oscillation clock at 10 MHz: 105 ms (Min)</li> <li>The sub-CR clock can be used as the source clock of the hardware watchdog timer.</li> </ul>					
Wild register	It can be used to replace 3 bytes of data.					
LIN-UART	No LIN-UART					
8/10-bit A/D converter	2 channels 8-bit or 10-bit resolution can be selected.					

Part number	MB95F572H	MB95F573H	MB95F574H	MB95F572K	MB95F573K	MB95F574K								
Parameter														
8/16-bit composite timer	1 channel <ul style="list-style-type: none"> <li>The timer can be configured as an "8-bit timer × 2 channels" or a "16-bit timer × 1 channel".</li> <li>It has the following functions: interval timer function, PWC function, PWM function and input capture function.</li> <li>Count clock: it can be selected from internal clocks (7 types) and external clocks.</li> <li>It can output square wave.</li> </ul>													
External interrupt	2 channels <ul style="list-style-type: none"> <li>Interrupt by edge detection (The rising edge, falling edge, or both edges can be selected.)</li> <li>It can be used to wake up the device from the standby mode.</li> </ul>													
On-chip debug	<ul style="list-style-type: none"> <li>1-wire serial control</li> <li>It supports serial writing (asynchronous mode).</li> </ul>													
Watch prescaler	Eight different time intervals can be selected.													
Flash memory	<ul style="list-style-type: none"> <li>It supports automatic programming (Embedded Algorithm), and program/erase/erase-suspend/erase-resume commands.</li> <li>It has a flag indicating the completion of the operation of Embedded Algorithm.</li> <li>Flash security feature for protecting the content of the Flash memory</li> </ul> <table border="1" style="width: 100%; margin-top: 10px;"> <tr> <td>Number of program/erase cycles</td> <td>1000</td> <td>10000</td> <td>100000</td> </tr> <tr> <td>Data retention time</td> <td>20 years</td> <td>10 years</td> <td>5 years</td> </tr> </table>						Number of program/erase cycles	1000	10000	100000	Data retention time	20 years	10 years	5 years
Number of program/erase cycles	1000	10000	100000											
Data retention time	20 years	10 years	5 years											
Standby mode	Sleep mode, stop mode, watch mode, time-base timer mode													
Package	PDA008 SOD008													

• MB95580H Series

Part number	MB95F582H	MB95F583H	MB95F584H	MB95F582K	MB95F583K	MB95F584K
Parameter						
Type	Flash memory product					
Clock supervisor counter	It supervises the main clock oscillation.					
Flash memory capacity	8 Kbyte	12 Kbyte	20 Kbyte	8 Kbyte	12 Kbyte	20 Kbyte
RAM capacity	240 bytes	496 bytes	496 bytes	240 bytes	496 bytes	496 bytes
Power-on reset	Yes					
Low-voltage detection reset	No			Yes		
Reset input	Dedicated			Selected through software		
CPU functions	<ul style="list-style-type: none"> <li>Number of basic instructions : 136</li> <li>Instruction bit length : 8 bits</li> <li>Instruction length : 1 to 3 bytes</li> <li>Data bit length : 1, 8 and 16 bits</li> <li>Minimum instruction execution time : 61.5 ns (machine clock frequency = 16.25 MHz)</li> <li>Interrupt processing time : 0.6 μs (machine clock frequency = 16.25 MHz)</li> </ul>					
General-purpose I/O	<ul style="list-style-type: none"> <li>I/O ports (Max) : 12</li> <li>CMOS I/O : 11</li> <li>N-ch open drain: 1</li> </ul>			<ul style="list-style-type: none"> <li>I/O ports (Max) : 13</li> <li>CMOS I/O : 11</li> <li>N-ch open drain: 2</li> </ul>		



Part number	MB95F582H	MB95F583H	MB95F584H	MB95F582K	MB95F583K	MB95F584K								
Parameter														
Time-base timer	Interval time: 0.256 ms to 8.3 s (external clock frequency = 4 MHz)													
Hardware/software watchdog timer	<ul style="list-style-type: none"> <li>Reset generation cycle</li> <li>Main oscillation clock at 10 MHz: 105 ms (Min)</li> <li>The sub-CR clock can be used as the source clock of the hardware watchdog timer.</li> </ul>													
Wild register	It can be used to replace 3 bytes of data.													
LIN-UART	<ul style="list-style-type: none"> <li>A wide range of communication speed can be selected by a dedicated reload timer.</li> <li>It has a full duplex double buffer.</li> <li>Both clock synchronous serial data transfer and clock asynchronous serial data transfer are enabled.</li> <li>The LIN function can be used as a LIN master or a LIN slave.</li> </ul>													
8/10-bit A/D converter	5 channels 8-bit or 10-bit resolution can be selected.													
8/16-bit composite timer	1 channel <ul style="list-style-type: none"> <li>The timer can be configured as an "8-bit timer × 2 channels" or a "16-bit timer × 1 channel".</li> <li>It has the following functions: interval timer function, PWC function, PWM function and input capture function.</li> <li>Count clock: it can be selected from internal clocks (7 types) and external clocks.</li> <li>It can output square wave.</li> </ul>													
External interrupt	6 channels <ul style="list-style-type: none"> <li>Interrupt by edge detection (The rising edge, falling edge, or both edges can be selected.)</li> <li>It can be used to wake up the device from the standby mode.</li> </ul>													
On-chip debug	<ul style="list-style-type: none"> <li>1-wire serial control</li> <li>It supports serial writing (asynchronous mode).</li> </ul>													
Watch prescaler	Eight different time intervals can be selected.													
Flash memory	<ul style="list-style-type: none"> <li>It supports automatic programming (Embedded Algorithm), and program/erase/erase-suspend/erase-resume commands.</li> <li>It has a flag indicating the completion of the operation of Embedded Algorithm.</li> <li>Flash security feature for protecting the content of the Flash memory</li> </ul> <table border="1" style="width: 100%; border-collapse: collapse;"> <tr> <td style="width: 40%;">Number of program/erase cycles</td> <td style="width: 15%;">1000</td> <td style="width: 15%;">10000</td> <td style="width: 15%;">100000</td> </tr> <tr> <td>Data retention time</td> <td>20 years</td> <td>10 years</td> <td>5 years</td> </tr> </table>						Number of program/erase cycles	1000	10000	100000	Data retention time	20 years	10 years	5 years
Number of program/erase cycles	1000	10000	100000											
Data retention time	20 years	10 years	5 years											
Standby mode	Sleep mode, stop mode, watch mode, time-base timer mode													
Package	WNP032 STB016 SO016													



## 2. Packages And Corresponding Products

• MB95560H Series

Part number / Package	MB95F562H	MB95F562K	MB95F563H	MB95F563K	MB95F564H	MB95F564K
WNP032	O	O	O	O	O	O
SOJ020	O	O	O	O	O	O
STG020	O	O	O	O	O	O
STB016	X	X	X	X	X	X
SO016	X	X	X	X	X	X
PDA008	X	X	X	X	X	X
SOD008	X	X	X	X	X	X

• MB95570H Series

Part number / Package	MB95F572H	MB95F572K	MB95F573H	MB95F573K	MB95F574H	MB95F574K
WNP032	X	X	X	X	X	X
SOJ020	X	X	X	X	X	X
STG020	X	X	X	X	X	X
STB016	X	X	X	X	X	X
SO016	X	X	X	X	X	X
PDA008	O	O	O	O	O	O
SOD008	O	O	O	O	O	O

• MB95580H Series

Part number / Package	MB95F582H	MB95F582K	MB95F583H	MB95F583K	MB95F584H	MB95F584K
WNP032	O	O	O	O	O	O
SOJ020	X	X	X	X	X	X
STG020	X	X	X	X	X	X
STB016	O	O	O	O	O	O
SO016	O	O	O	O	O	O
PDA008	X	X	X	X	X	X
SOD008	X	X	X	X	X	X

O: Available  
X: Unavailable





### **3. Differences Among Products And Notes On Product Selection**

- **Current consumption**  
When using the on-chip debug function, take account of the current consumption of Flash memory program/erase. For details of current consumption, see “Electrical Characteristics”.
- **Package**  
For details of information on each package, see “Packages And Corresponding Products” and “Package Dimension”.
- **Operating voltage**  
The operating voltage varies, depending on whether the on-chip debug function is used or not. For details of the operating voltage, see “Electrical Characteristics”.
- **On-chip debug function**  
The on-chip debug function requires that  $V_{CC}$ ,  $V_{SS}$  and one serial wire be connected to an evaluation tool. For details of the connection method, refer to “CHAPTER 21 EXAMPLE OF SERIAL PROGRAMMING CONNECTION” in “New 8FX MB95560H/570H/580H Hardware Manual”.

### 4. Pin Assignment

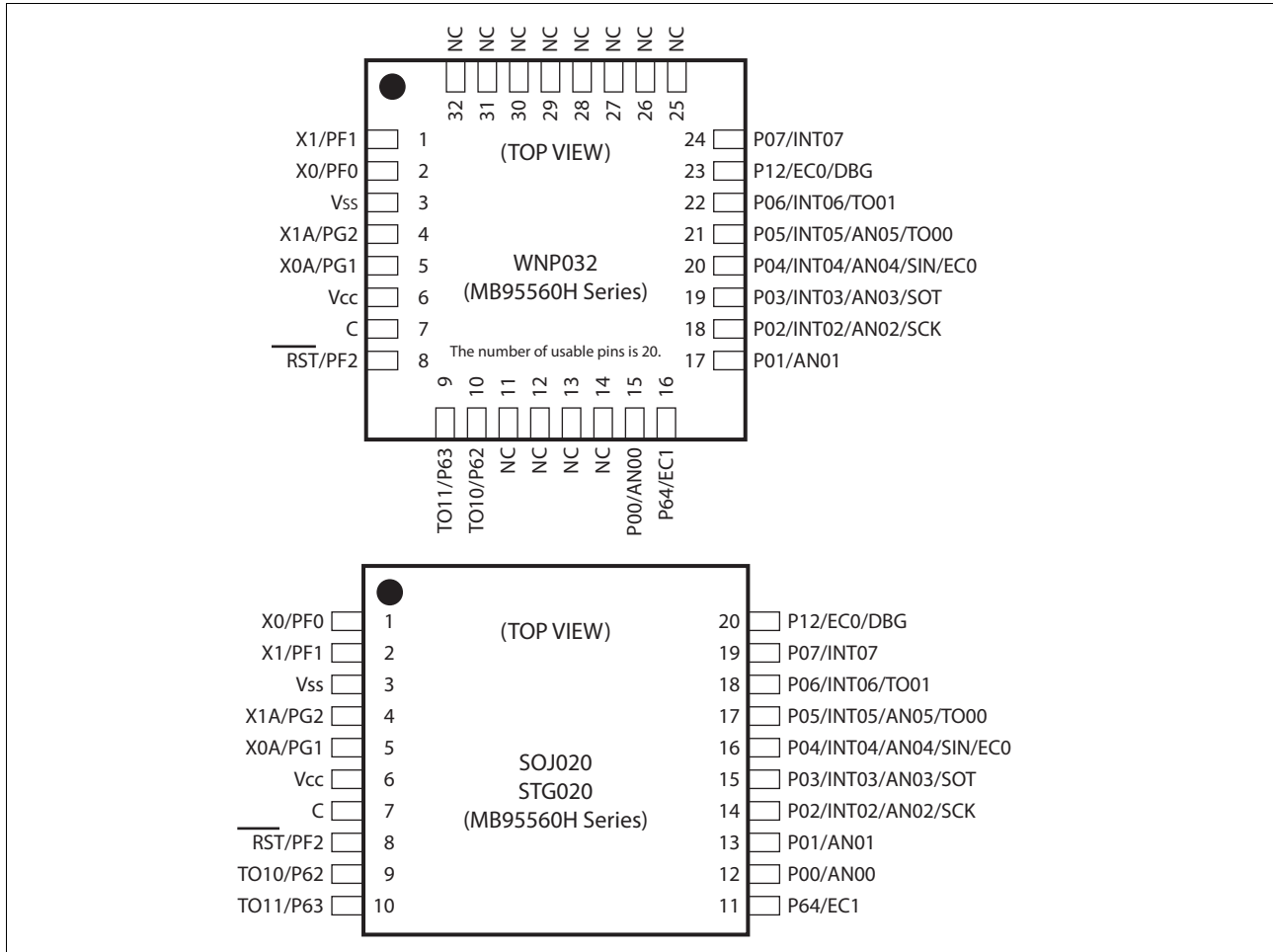

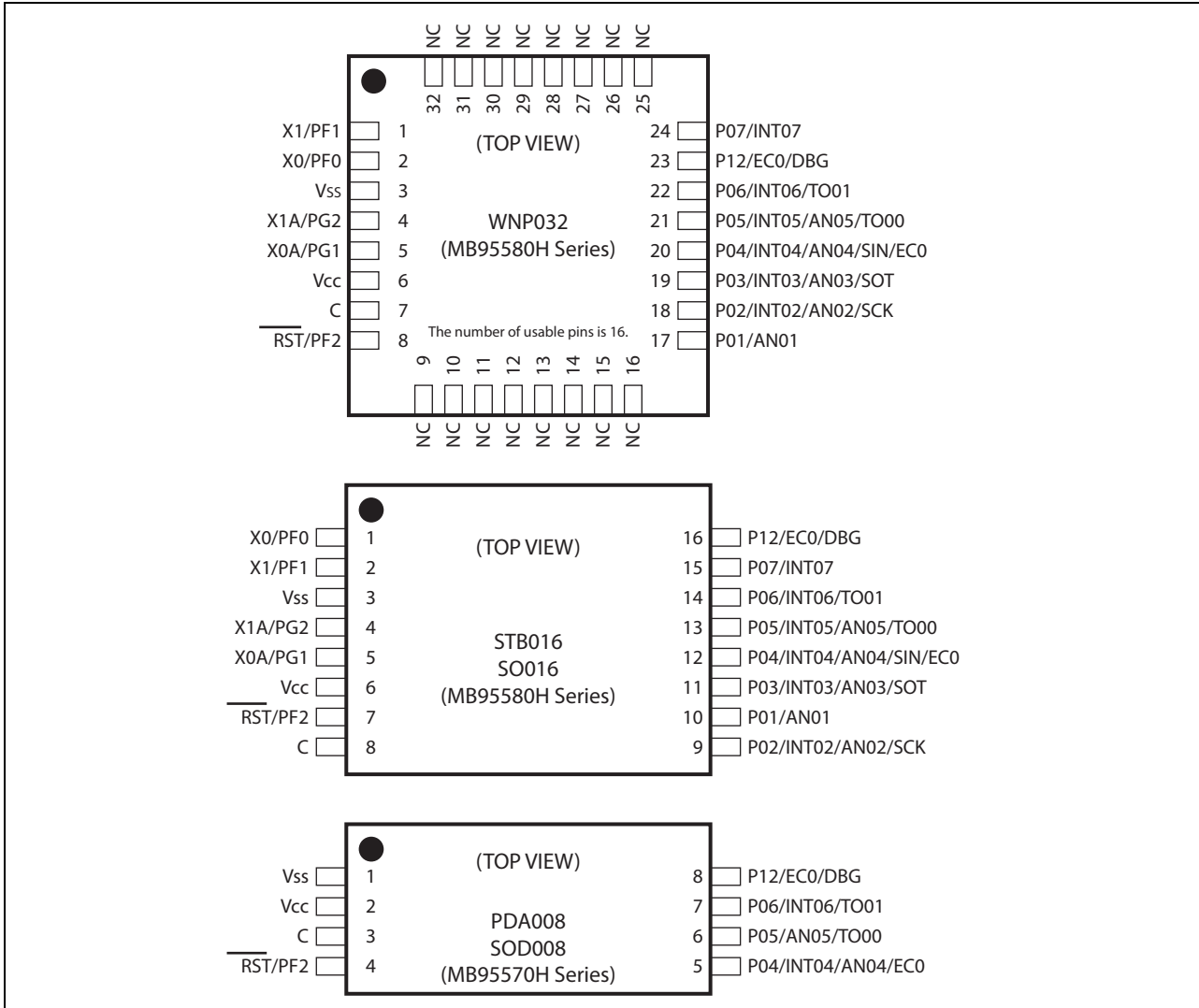



**5. Pin Functions (MB95560H Series, 32 pins)**

Pin no.	Pin name	I/O circuit type*	Function
1	PF1	B	General-purpose I/O port
	X1		Main clock I/O oscillation pin
2	PF0	B	General-purpose I/O port
	X0		Main clock input oscillation pin
3	V <sub>ss</sub>	—	Power supply pin (GND)
4	PG2	C	General-purpose I/O port
	X1A		Subclock I/O oscillation pin
5	PG1	C	General-purpose I/O port
	X0A		Subclock input oscillation pin
6	V <sub>cc</sub>	—	Power supply pin
7	C	—	Decoupling capacitor connection pin
8	PF2	A	General-purpose I/O port
	$\overline{\text{RST}}$		Reset pin Dedicated reset pin on MB95F562H/F563H/F564H
9	P63	E	General-purpose I/O port High-current pin
	TO11		8/16-bit composite timer ch. 1 output pin
10	P62	E	General-purpose I/O port High-current pin
	TO10		8/16-bit composite timer ch. 1 output pin
11	NC	—	It is an internally connected pin. Always leave it unconnected.
12			
13			
14			
15	P00	D	General-purpose I/O port High-current pin
	AN00		A/D converter analog input pin
16	P64	E	General-purpose I/O port High-current pin
	EC1		8/16-bit composite timer ch. 1 clock input pin
17	P01	D	General-purpose I/O port High-current pin
	AN01		A/D converter analog input pin
18	P02	D	General-purpose I/O port High-current pin
	INT02		External interrupt input pin
	AN02		A/D converter analog input pin
	SCK		LIN-UART clock I/O pin



Pin no.	Pin name	I/O circuit type*	Function
19	P03	D	General-purpose I/O port High-current pin
	INT03		External interrupt input pin
	AN03		A/D converter analog input pin
	SOT		LIN-UART data output pin
20	P04	D	General-purpose I/O port High-current pin
	INT04		External interrupt input pin
	AN04		A/D converter analog input pin
	SIN		LIN-UART data input pin
	EC0		8/16-bit composite timer ch. 0 clock input pin
21	P05	D	General-purpose I/O port High-current pin
	INT05		External interrupt input pin
	AN05		A/D converter analog input pin
	TO00		8/16-bit composite timer ch. 0 output pin
22	P06	E	General-purpose I/O port High-current pin
	INT06		External interrupt input pin
	TO01		8/16-bit composite timer ch. 0 output pin
23	P12	F	General-purpose I/O port
	EC0		8/16-bit composite timer ch. 0 clock input pin
	DBG		DBG input pin
24	P07	E	General-purpose I/O port High-current pin
	INT07		External interrupt input pin
25	NC	—	It is an internally connected pin. Always leave it unconnected.
26			
27			
28			
29			
30			
31			
32			

\*: For the I/O circuit types, see "I/O Circuit Type".



6. Pin Functions (MB95560H Series, 20 pins)

Pin no.	Pin name	I/O circuit type*	Function
1	PF0	B	General-purpose I/O port
	X0		Main clock input oscillation pin
2	PF1	B	General-purpose I/O port
	X1		Main clock I/O oscillation pin
3	V <sub>ss</sub>	—	Power supply pin (GND)
4	PG2	C	General-purpose I/O port
	X1A		Subclock I/O oscillation pin
5	PG1	C	General-purpose I/O port
	X0A		Subclock input oscillation pin
6	V <sub>cc</sub>	—	Power supply pin
7	C	—	Decoupling capacitor connection pin
8	PF2	A	General-purpose I/O port
	$\overline{\text{RST}}$		Reset pin Dedicated reset pin on MB95F562H/F563H/F564H
9	P62	E	General-purpose I/O port High-current pin
	TO10		8/16-bit composite timer ch. 1 output pin
10	P63	E	General-purpose I/O port High-current pin
	TO11		8/16-bit composite timer ch. 1 output pin
11	P64	E	General-purpose I/O port High-current pin
	EC1		8/16-bit composite timer ch. 1 clock input pin
12	P00	D	General-purpose I/O port High-current pin
	AN00		A/D converter analog input pin
13	P01	D	General-purpose I/O port High-current pin
	AN01		A/D converter analog input pin
14	P02	D	General-purpose I/O port High-current pin
	INT02		External interrupt input pin
	AN02		A/D converter analog input pin
	SCK		LIN-UART clock I/O pin
15	P03	D	General-purpose I/O port High-current pin
	INT03		External interrupt input pin
	AN03		A/D converter analog input pin
	SOT		LIN-UART data output pin



Pin no.	Pin name	I/O circuit type*	Function
16	P04	D	General-purpose I/O port
	INT04		External interrupt input pin
	AN04		A/D converter analog input pin
	SIN		LIN-UART data input pin
	EC0		8/16-bit composite timer ch. 0 clock input pin
17	P05	D	General-purpose I/O port High-current pin
	INT05		External interrupt input pin
	AN05		A/D converter analog input pin
	TO00		8/16-bit composite timer ch. 0 output pin
18	P06	E	General-purpose I/O port High-current pin
	INT06		External interrupt input pin
	TO01		8/16-bit composite timer ch. 0 output pin
19	P07	E	General-purpose I/O port High-current pin
	INT07		External interrupt input pin
20	P12	F	General-purpose I/O port
	EC0		8/16-bit composite timer ch. 0 clock input pin
	DBG		DBG input pin

\*: For the I/O circuit types, see "I/O Circuit Type".



**7. Pin Functions (MB95570H Series, 8 pins)**

Pin no.	Pin name	I/O circuit type*	Function
1	V <sub>ss</sub>	—	Power supply pin (GND)
2	V <sub>cc</sub>	—	Power supply pin
3	C	—	Decoupling capacitor connection pin
4	PF2	A	General-purpose I/O port
	$\overline{\text{RST}}$		Reset pin Dedicated reset pin on MB95F572H/F573H/F574H
5	P04	D	General-purpose I/O port
	INT04		External interrupt input pin
	AN04		A/D converter analog input pin
	EC0		8/16-bit composite timer ch. 0 clock input pin
6	P05	D	General-purpose I/O port High-current pin
	AN05		A/D converter analog input pin
	TO00		8/16-bit composite timer ch. 0 output pin
7	P06	E	General-purpose I/O port High-current pin
	INT06		External interrupt input pin
	TO01		8/16-bit composite timer ch. 0 output pin
8	P12	F	General-purpose I/O port
	EC0		8/16-bit composite timer ch. 0 clock input pin
	DBG		DBG input pin

\*: For the I/O circuit types, see “I/O Circuit Type”.





**8. Pin Functions (MB95580H Series, 32 pins)**

Pin no.	Pin name	I/O circuit type*	Function
1	PF1	B	General-purpose I/O port
	X1		Main clock I/O oscillation pin
2	PF0	B	General-purpose I/O port
	X0		Main clock input oscillation pin
3	V <sub>ss</sub>	—	Power supply pin (GND)
4	PG2	C	General-purpose I/O port
	X1A		Subclock I/O oscillation pin
5	PG1	C	General-purpose I/O port
	X0A		Subclock input oscillation pin
6	V <sub>cc</sub>	—	Power supply pin
7	C	—	Decoupling capacitor connection pin
8	PF2	A	General-purpose I/O port
	$\overline{\text{RST}}$		Reset pin Dedicated reset pin on MB95F582H/F583H/F584H
9	NC	—	It is an internally connected pin. Always leave it unconnected.
10			
11			
12			
13			
14			
15			
16			
17	P01	D	General-purpose I/O port High-current pin
	AN01		A/D converter analog input pin
18	P02	D	General-purpose I/O port High-current pin
	INT02		External interrupt input pin
	AN02		A/D converter analog input pin
	SCK		LIN-UART clock I/O pin
19	P03	D	General-purpose I/O port High-current pin
	INT03		External interrupt input pin
	AN03		A/D converter analog input pin
	SOT		LIN-UART data output pin



Pin no.	Pin name	I/O circuit type*	Function
20	P04	D	General-purpose I/O port
	INT04		External interrupt input pin
	AN04		A/D converter analog input pin
	SIN		LIN-UART data input pin
	EC0		8/16-bit composite timer ch. 0 clock input pin
21	P05	D	General-purpose I/O port High-current pin
	INT05		External interrupt input pin
	AN05		A/D converter analog input pin
	TO00		8/16-bit composite timer ch. 0 output pin
22	P06	E	General-purpose I/O port High-current pin
	INT06		External interrupt input pin
	TO01		8/16-bit composite timer ch. 0 output pin
23	P12	F	General-purpose I/O port
	EC0		8/16-bit composite timer ch. 0 clock input pin
	DBG		DBG input pin
24	P07	E	General-purpose I/O port High-current pin
	INT07		External interrupt input pin
25	NC	—	It is an internally connected pin. Always leave it unconnected.
26			
27			
28			
29			
30			
31			
32			

\*: For the I/O circuit types, see "I/O Circuit Type".



9. Pin Functions (MB95580H Series, 16 pins)

Pin no.	Pin name	I/O circuit type*	Function
1	PF0	B	General-purpose I/O port
	X0		Main clock input oscillation pin
2	PF1	B	General-purpose I/O port
	X1		Main clock I/O oscillation pin
3	V <sub>ss</sub>	—	Power supply pin (GND)
4	PG2	C	General-purpose I/O port
	X1A		Subclock I/O oscillation pin
5	PG1	C	General-purpose I/O port
	X0A		Subclock input oscillation pin
6	V <sub>cc</sub>	—	Power supply pin
7	PF2	A	General-purpose I/O port
	$\overline{\text{RST}}$		Reset pin Dedicated reset pin on MB95F582H/F583H/F584H
8	C	—	Decoupling capacitor connection pin
9	P02	D	General-purpose I/O port High-current pin
	INT02		External interrupt input pin
	AN02		A/D converter analog input pin
	SCK		LIN-UART clock I/O pin
10	P01	D	General-purpose I/O port High-current pin
	AN01		A/D converter analog input pin
11	P03	D	General-purpose I/O port High-current pin
	INT03		External interrupt input pin
	AN03		A/D converter analog input pin
	SOT		LIN-UART data output pin
12	P04	D	General-purpose I/O port
	INT04		External interrupt input pin
	AN04		A/D converter analog input pin
	SIN		LIN-UART data input pin
	EC0		8/16-bit composite timer ch. 0 clock input pin



Pin no.	Pin name	I/O circuit type*	Function
13	P05	D	General-purpose I/O port High-current pin
	INT05		External interrupt input pin
	AN05		A/D converter analog input pin
	TO00		8/16-bit composite timer ch. 0 output pin
14	P06	E	General-purpose I/O port High-current pin
	INT06		External interrupt input pin
	TO01		8/16-bit composite timer ch. 0 output pin
15	P07	E	General-purpose I/O port High-current pin
	INT07		External interrupt input pin
16	P12	F	General-purpose I/O port
	EC0		8/16-bit composite timer ch. 0 clock input pin
	DBG		DBG input pin

\*: For the I/O circuit types, see "I/O Circuit Type".



**10. I/O Circuit Type**

Type	Circuit	Remarks
A		<ul style="list-style-type: none"> <li>• N-ch open drain output</li> <li>• Hysteresis input</li> <li>• Reset output</li> </ul>
B		<ul style="list-style-type: none"> <li>• Oscillation circuit</li> <li>• High-speed side</li> <li>Feedback resistance: approx. 1 MΩ</li> <li>• CMOS output</li> <li>• Hysteresis input</li> </ul>
C		<ul style="list-style-type: none"> <li>• Oscillation circuit</li> <li>• Low-speed side</li> <li>Feedback resistance: approx. 10 MΩ</li> <li>• CMOS output</li> <li>• Hysteresis input</li> <li>• Pull-up control available</li> </ul>



Type	Circuit	Remarks
D		<ul style="list-style-type: none"> <li>• CMOS output</li> <li>• Hysteresis input</li> <li>• Pull-up control available</li> <li>• Analog input</li> </ul>
E		<ul style="list-style-type: none"> <li>• CMOS output</li> <li>• Hysteresis input</li> <li>• Pull-up control available</li> </ul>
F		<ul style="list-style-type: none"> <li>• N-ch open drain output</li> <li>• Hysteresis input</li> </ul>

## 11. Handling Precautions

Any semiconductor devices have inherently a certain rate of failure. The possibility of failure is greatly affected by the conditions in which they are used (circuit conditions, environmental conditions, etc.). This page describes precautions that must be observed to minimize the chance of failure and to obtain higher reliability from your Cypress semiconductor devices.

### 11.1 Precautions for Product Design

This section describes precautions when designing electronic equipment using semiconductor devices.

#### • Absolute Maximum Ratings

Semiconductor devices can be permanently damaged by application of stress (voltage, current, temperature, etc.) in excess of certain established limits, called absolute maximum ratings. Do not exceed these ratings.

#### • Recommended Operating Conditions

Recommended operating conditions are normal operating ranges for the semiconductor device. All the device's electrical characteristics are warranted when operated within these ranges.

Always use semiconductor devices within the recommended operating conditions. Operation outside these ranges may adversely affect reliability and could result in device failure.

No warranty is made with respect to uses, operating conditions, or combinations not represented on the data sheet. Users considering application outside the listed conditions are advised to contact their sales representative beforehand.



- **Processing and Protection of Pins**

These precautions must be followed when handling the pins which connect semiconductor devices to power supply and input/output functions.

- (1) Preventing Over-Voltage and Over-Current Conditions

Exposure to voltage or current levels in excess of maximum ratings at any pin is likely to cause deterioration within the device, and in extreme cases leads to permanent damage of the device. Try to prevent such overvoltage or over-current conditions at the design stage.

- (2) Protection of Output Pins

Shorting of output pins to supply pins or other output pins, or connection to large capacitance can cause large current flows. Such conditions if present for extended periods of time can damage the device.

Therefore, avoid this type of connection.

- (3) Handling of Unused Input Pins

Unconnected input pins with very high impedance levels can adversely affect stability of operation. Such pins should be connected through an appropriate resistance to a power supply pin or ground pin.

- **Latch-up**

Semiconductor devices are constructed by the formation of P-type and N-type areas on a substrate. When subjected to abnormally high voltages, internal parasitic PNPN junctions (called thyristor structures) may be formed, causing large current levels in excess of several hundred mA to flow continuously at the power supply pin. This condition is called latch-up.

CAUTION: The occurrence of latch-up not only causes loss of reliability in the semiconductor device, but can cause injury or damage from high heat, smoke or flame. To prevent this from happening, do the following:

- (1) Be sure that voltages applied to pins do not exceed the absolute maximum ratings. This should include attention to abnormal noise, surge levels, etc.

- (2) Be sure that abnormal current flows do not occur during the power-on sequence.

- **Observance of Safety Regulations and Standards**

Most countries in the world have established standards and regulations regarding safety, protection from electromagnetic interference, etc. Customers are requested to observe applicable regulations and standards in the design of products.

- **Fail-Safe Design**

Any semiconductor devices have inherently a certain rate of failure. You must protect against injury, damage or loss from such failures by incorporating safety design measures into your facility and equipment such as redundancy, fire protection, and prevention of over-current levels and other abnormal operating conditions.

- **Precautions Related to Usage of Devices**

Cypress semiconductor devices are intended for use in standard applications (computers, office automation and other office equipment, industrial, communications, and measurement equipment, personal or household devices, etc.).

CAUTION: Customers considering the use of our products in special applications where failure or abnormal operation may directly affect human lives or cause physical injury or property damage, or where extremely high levels of reliability are demanded (such as aerospace systems, atomic energy controls, sea floor repeaters, vehicle operating controls, medical devices for life support, etc.) are requested to consult with sales representatives before such use. The company will not be responsible for damages arising from such use without prior approval.



## 11.2 Precautions for Package Mounting

Package mounting may be either lead insertion type or surface mount type. In either case, for heat resistance during soldering, you should only mount under Cypress's recommended conditions. For detailed information about mount conditions, contact your sales representative.

### • Lead Insertion Type

Mounting of lead insertion type packages onto printed circuit boards may be done by two methods: direct soldering on the board, or mounting by using a socket.

Direct mounting onto boards normally involves processes for inserting leads into through-holes on the board and using the flow soldering (wave soldering) method of applying liquid solder. In this case, the soldering process usually causes leads to be subjected to thermal stress in excess of the absolute ratings for storage temperature. Mounting processes should conform to Cypress recommended mounting conditions.

If socket mounting is used, differences in surface treatment of the socket contacts and IC lead surfaces can lead to contact deterioration after long periods. For this reason it is recommended that the surface treatment of socket contacts and IC leads be verified before mounting.

### • Surface Mount Type

Surface mount packaging has longer and thinner leads than lead-insertion packaging, and therefore leads are more easily deformed or bent. The use of packages with higher pin counts and narrower pin pitch results in increased susceptibility to open connections caused by deformed pins, or shorting due to solder bridges.

You must use appropriate mounting techniques. Cypress recommends the solder reflow method, and has established a ranking of mounting conditions for each product. Users are advised to mount packages in accordance with Cypress ranking of recommended conditions.

### • Lead-Free Packaging

**CAUTION:** When ball grid array (BGA) packages with Sn-Ag-Cu balls are mounted using Sn-Pb eutectic soldering, junction strength may be reduced under some conditions of use.

### • Storage of Semiconductor Devices

Because plastic chip packages are formed from plastic resins, exposure to natural environmental conditions will cause absorption of moisture. During mounting, the application of heat to a package that has absorbed moisture can cause surfaces to peel, reducing moisture resistance and causing packages to crack. To prevent, do the following:

- (1) Avoid exposure to rapid temperature changes, which cause moisture to condense inside the product. Store products in locations where temperature changes are slight.
- (2) Use dry boxes for product storage. Products should be stored below 70% relative humidity, and at temperatures between 5°C and 30°C.  
When you open Dry Package that recommends humidity 40% to 70% relative humidity.
- (3) When necessary, Cypress packages semiconductor devices in highly moisture-resistant aluminum laminate bags, with a silica gel desiccant. Devices should be sealed in their aluminum laminate bags for storage.
- (4) Avoid storing packages where they are exposed to corrosive gases or high levels of dust.

### • Baking

Packages that have absorbed moisture may be de-moisturized by baking (heat drying). Follow the Cypress recommended conditions for baking.

Condition: 125°C/24 h

### • Static Electricity

Because semiconductor devices are particularly susceptible to damage by static electricity, you must take the following precautions:





- (1) Maintain relative humidity in the working environment between 40% and 70%.  
Use of an apparatus for ion generation may be needed to remove electricity.
- (2) Electrically ground all conveyors, solder vessels, soldering irons and peripheral equipment.
- (3) Eliminate static body electricity by the use of rings or bracelets connected to ground through high resistance (on the level of 1 M $\Omega$ ).  
Wearing of conductive clothing and shoes, use of conductive floor mats and other measures to minimize shock loads is recommended.
- (4) Ground all fixtures and instruments, or protect with anti-static measures.
- (5) Avoid the use of styrofoam or other highly static-prone materials for storage of completed board assemblies.

### 11.3 Precautions for Use Environment

Reliability of semiconductor devices depends on ambient temperature and other conditions as described above.

For reliable performance, do the following:

#### (1) Humidity

Prolonged use in high humidity can lead to leakage in devices as well as printed circuit boards. If high humidity levels are anticipated, consider anti-humidity processing.

#### (2) Discharge of Static Electricity

When high-voltage charges exist close to semiconductor devices, discharges can cause abnormal operation. In such cases, use anti-static measures or processing to prevent discharges.

#### (3) Corrosive Gases, Dust, or Oil

Exposure to corrosive gases or contact with dust or oil may lead to chemical reactions that will adversely affect the device. If you use devices in such conditions, consider ways to prevent such exposure or to protect the devices.

#### (4) Radiation, Including Cosmic Radiation

Most devices are not designed for environments involving exposure to radiation or cosmic radiation. Users should provide shielding as appropriate.

#### (5) Smoke, Flame

**CAUTION:** Plastic molded devices are flammable, and therefore should not be used near combustible substances. If devices begin to smoke or burn, there is danger of the release of toxic gases.

Customers considering the use of Cypress products in other special environmental conditions should consult with sales representatives.

## 12. Notes On Device Handling

- Preventing latch-ups

When using the device, ensure that the voltage applied does not exceed the maximum voltage rating.

In a CMOS IC, if a voltage higher than  $V_{CC}$  or a voltage lower than  $V_{SS}$  is applied to an input/output pin that is neither a medium-withstand voltage pin nor a high-withstand voltage pin, or if a voltage out of the rating range of power supply voltage mentioned in "24.1 Absolute Maximum Ratings" of "Electrical Characteristics" is applied to the  $V_{CC}$  pin or the  $V_{SS}$  pin, a latch-up may occur.

When a latch-up occurs, power supply current increases significantly, which may cause a component to be thermally destroyed.

- Stabilizing supply voltage



Supply voltage must be stabilized.

A malfunction may occur when power supply voltage fluctuates rapidly even though the fluctuation is within the guaranteed operating range of the  $V_{CC}$  power supply voltage.

As a rule of voltage stabilization, suppress voltage fluctuation so that the fluctuation in  $V_{CC}$  ripple (p-p value) at the commercial frequency (50 Hz/60 Hz) does not exceed 10% of the standard  $V_{CC}$  value, and the transient fluctuation rate does not exceed 0.1 V/ms at a momentary fluctuation such as switching the power supply.

- Notes on using the external clock  
When an external clock is used, oscillation stabilization wait time is required for power-on reset, wake-up from subclock mode or stop mode.

### 13. Pin Connection

- Treatment of unused pins  
If an unused input pin is left unconnected, a component may be permanently damaged due to malfunctions or latch-ups. Always pull up or pull down an unused input pin through a resistor of at least 2 k $\Omega$ . Set an unused input/output pin to the output state and leave it unconnected, or set it to the input state and treat it the same as an unused input pin. If there is an unused output pin, leave it unconnected.
- Power supply pins  
To reduce unnecessary electro-magnetic emission, prevent malfunctions of strobe signals due to an increase in the ground level, and conform to the total output current standard, always connect the  $V_{CC}$  pin and the  $V_{SS}$  pin to the power supply and ground outside the device. In addition, connect the current supply source to the  $V_{CC}$  pin and the  $V_{SS}$  pin with low impedance.  
It is also advisable to connect a ceramic capacitor of approximately 0.1  $\mu$ F as a decoupling capacitor between the  $V_{CC}$  pin and the  $V_{SS}$  pin at a location close to this device.
- DBG pin  
Connect the DBG pin to an external pull-up resistor of 2 k $\Omega$  or above.  
After power-on, ensure that the DBG pin does not stay at "L" level until the reset output is released.  
The DBG pin becomes a communication pin in debug mode. Since the actual pull-up resistance depends on the tool used and the interconnection length, refer to the tool document when selecting a pull-up resistor.
- $\overline{RST}$  pin  
Connect the  $\overline{RST}$  pin to an external pull-up resistor of 2 k $\Omega$  or above.  
To prevent the device from unintentionally entering the reset mode due to noise, minimize the interconnection length between a pull-up resistor and the  $\overline{RST}$  pin and that between a pull-up resistor and the  $V_{CC}$  pin when designing the layout of the printed circuit board.  
The PF2/ $\overline{RST}$  pin functions as the reset input/output pin after power-on. In addition, the reset output of the PF2/ $\overline{RST}$  pin can be enabled by the RSTOE bit in the SYSC register, and the reset input function and the general purpose I/O function can be selected by the RSTEN bit in the SYSC register.
- C pin  
Use a ceramic capacitor or a capacitor with equivalent frequency characteristics. The decoupling capacitor for the  $V_{CC}$  pin must have a capacitance equal to or larger than the capacitance of  $C_s$ . For the connection to a decoupling capacitor  $C_s$ , see the diagram below. To prevent the device from unintentionally entering a mode to which the device is not set to transit due to noise, minimize the distance between the C pin and  $C_s$  and the distance between  $C_s$  and the  $V_{SS}$  pin when designing the layout of a printed circuit board.

- $\overline{\text{DBG}}/\overline{\text{RST}}/\text{C}$  pins connection diagram

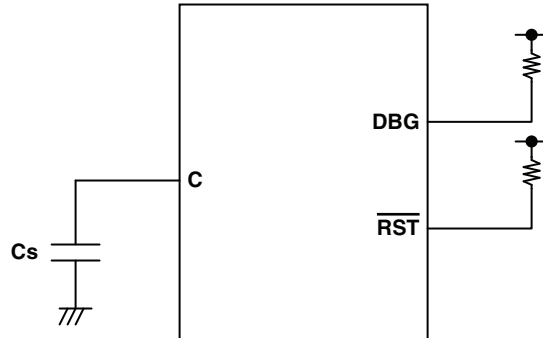

### 14. Block Diagram (MB95560H Series)

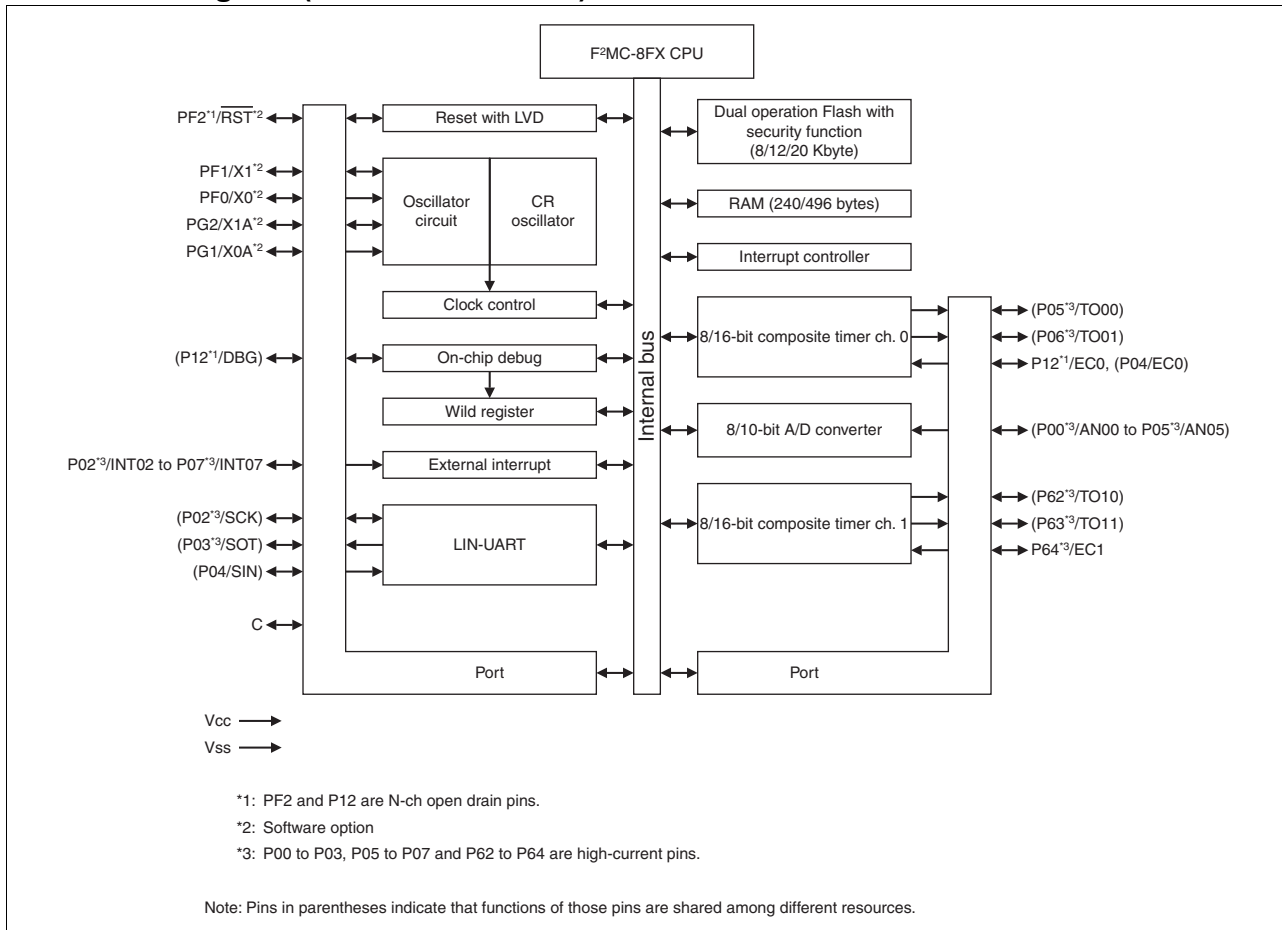

### 15. Block Diagram (MB95570H Series)

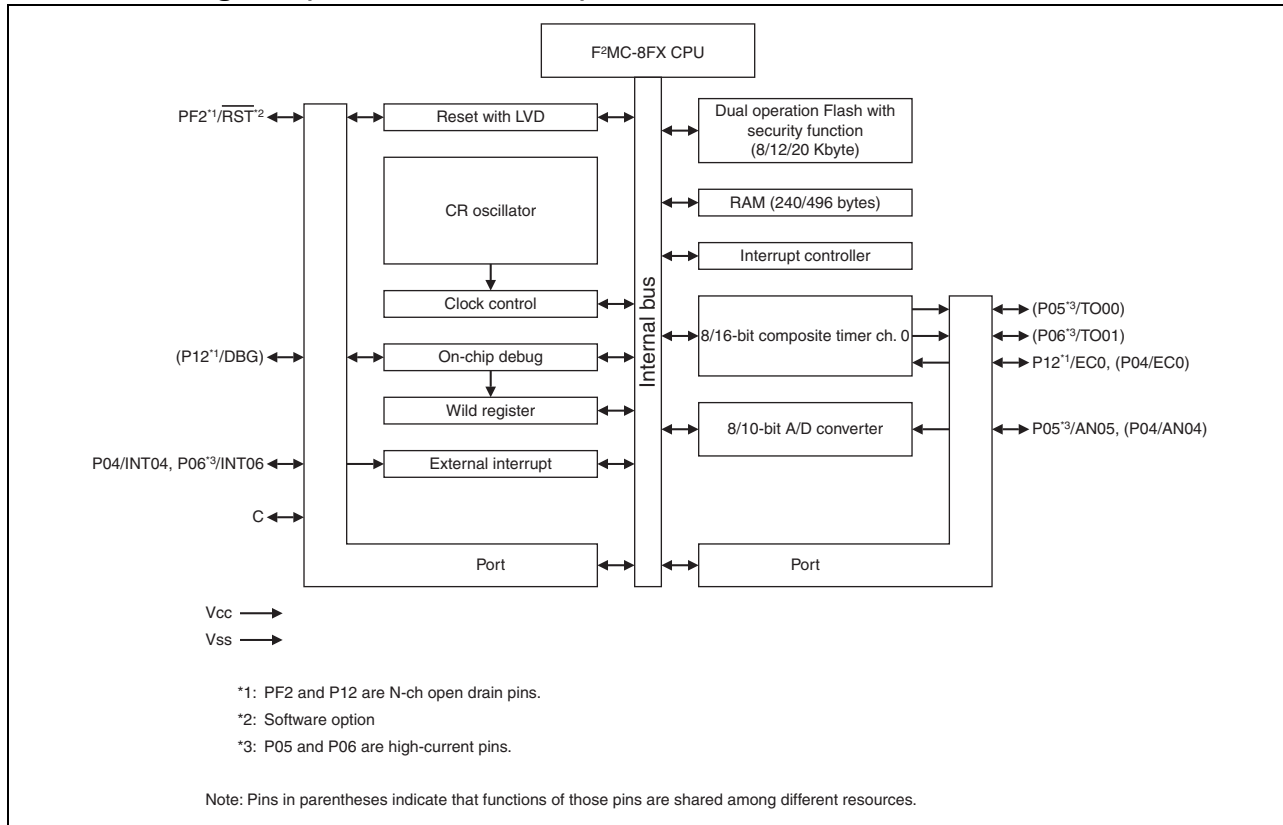

## 16. Block Diagram (MB95580H Series)

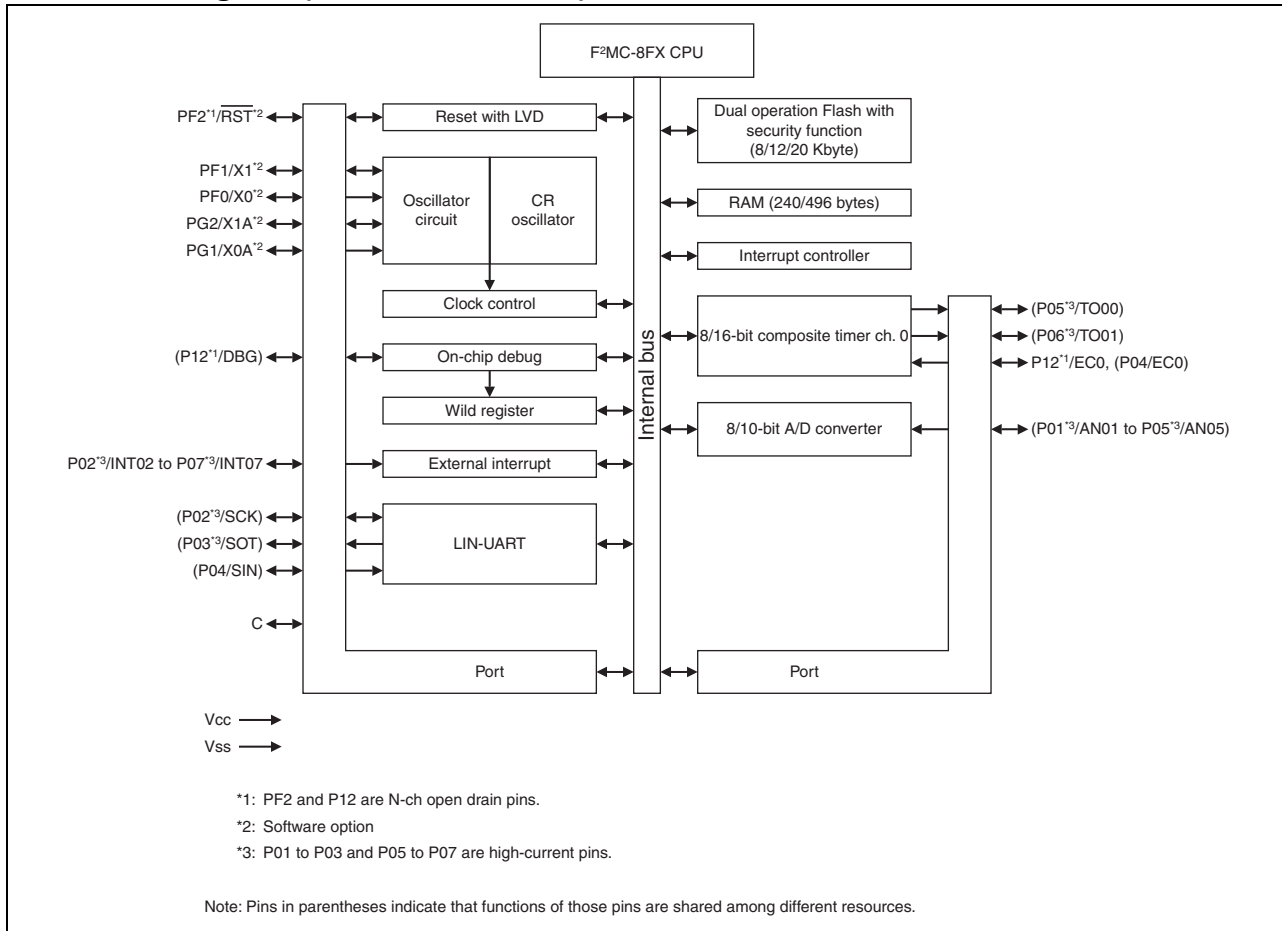

## 17. CPU Core

- Memory space

The memory space of the MB95560H/570H/580H is 64 Kbyte in size, and consists of an I/O area, a data area, and a program area. The memory space includes areas intended for specific purposes such as general-purpose registers and a vector table. The memory maps of the MB95560H/570H/580H are shown below.8

- Memory maps

MB95F562H/F562K/F572H/ F572K/F582H/F582K	MB95F563H/F563K/F573H/ F573K/F583H/F583K	MB95F564H/F564K/F574H/ F574K/F584H/F584K
0000 <sub>H</sub>	0000 <sub>H</sub>	0000 <sub>H</sub>
0080 <sub>H</sub>	0080 <sub>H</sub>	0080 <sub>H</sub>
0090 <sub>H</sub>	0090 <sub>H</sub>	0090 <sub>H</sub>
0100 <sub>H</sub>	0100 <sub>H</sub>	0100 <sub>H</sub>
0180 <sub>H</sub>	0200 <sub>H</sub>	0200 <sub>H</sub>
	0280 <sub>H</sub>	0280 <sub>H</sub>
0F80 <sub>H</sub>	0F80 <sub>H</sub>	0F80 <sub>H</sub>
1000 <sub>H</sub>	1000 <sub>H</sub>	1000 <sub>H</sub>
B000 <sub>H</sub>	B000 <sub>H</sub>	B000 <sub>H</sub>
C000 <sub>H</sub>	C000 <sub>H</sub>	
F000 <sub>H</sub>	E000 <sub>H</sub>	
FFFF <sub>H</sub>	FFFF <sub>H</sub>	FFFF <sub>H</sub>



**18. I/O Map (MB95560H Series)**

Address	Register abbreviation	Register name	R/W	Initial value
0000 <sub>H</sub>	PDR0	Port 0 data register	R/W	00000000 <sub>B</sub>
0001 <sub>H</sub>	DDR0	Port 0 direction register	R/W	00000000 <sub>B</sub>
0002 <sub>H</sub>	PDR1	Port 1 data register	R/W	00000000 <sub>B</sub>
0003 <sub>H</sub>	DDR1	Port 1 direction register	R/W	00000000 <sub>B</sub>
0004 <sub>H</sub>	—	(Disabled)	—	—
0005 <sub>H</sub>	WATR	Oscillation stabilization wait time setting register	R/W	11111111 <sub>B</sub>
0006 <sub>H</sub>	PLLC	PLL control register	R/W	000X0000 <sub>B</sub>
0007 <sub>H</sub>	SYCC	System clock control register	R/W	XXX11011 <sub>B</sub>
0008 <sub>H</sub>	STBC	Standby control register	R/W	00000000 <sub>B</sub>
0009 <sub>H</sub>	RSRR	Reset source register	R/W	000XXXXX <sub>B</sub>
000A <sub>H</sub>	TBTC	Time-base timer control register	R/W	00000000 <sub>B</sub>
000B <sub>H</sub>	WPCR	Watch prescaler control register	R/W	00000000 <sub>B</sub>
000C <sub>H</sub>	WDTC	Watchdog timer control register	R/W	00XX0000 <sub>B</sub>
000D <sub>H</sub>	SYCC2	System clock control register 2	R/W	XXXX0011 <sub>B</sub>
000E <sub>H</sub>	STBC2	Standby control register 2	R/W	00000000 <sub>B</sub>
000F <sub>H</sub> to 0015 <sub>H</sub>	—	(Disabled)	—	—
0016 <sub>H</sub>	PDR6	Port 6 data register	R/W	00000000 <sub>B</sub>
0017 <sub>H</sub>	DDR6	Port 6 direction register	R/W	00000000 <sub>B</sub>
0018 <sub>H</sub> to 0027 <sub>H</sub>	—	(Disabled)	—	—
0028 <sub>H</sub>	PDRF	Port F data register	R/W	00000000 <sub>B</sub>
0029 <sub>H</sub>	DDRF	Port F direction register	R/W	00000000 <sub>B</sub>
002A <sub>H</sub>	PDRG	Port G data register	R/W	00000000 <sub>B</sub>
002B <sub>H</sub>	DDRG	Port G direction register	R/W	00000000 <sub>B</sub>
002C <sub>H</sub>	PUL0	Port 0 pull-up register	R/W	00000000 <sub>B</sub>
002D <sub>H</sub> to 0032 <sub>H</sub>	—	(Disabled)	—	—
0033 <sub>H</sub>	PUL6	Port 6 pull-up register	R/W	00000000 <sub>B</sub>
0034 <sub>H</sub>	—	(Disabled)	—	—
0035 <sub>H</sub>	PULG	Port G pull-up register	R/W	00000000 <sub>B</sub>
0036 <sub>H</sub>	T01CR1	8/16-bit composite timer 01 status control register 1	R/W	00000000 <sub>B</sub>
0037 <sub>H</sub>	T00CR1	8/16-bit composite timer 00 status control register 1	R/W	00000000 <sub>B</sub>
0038 <sub>H</sub>	T11CR1	8/16-bit composite timer 11 status control register 1	R/W	00000000 <sub>B</sub>
0039 <sub>H</sub>	T10CR1	8/16-bit composite timer 10 status control register 1	R/W	00000000 <sub>B</sub>
003A <sub>H</sub> to 0048 <sub>H</sub>	—	(Disabled)	—	—



Address	Register abbreviation	Register name	R/W	Initial value
0049 <sub>H</sub>	EIC10	External interrupt circuit control register ch. 2/ch. 3	R/W	00000000 <sub>B</sub>
004A <sub>H</sub>	EIC20	External interrupt circuit control register ch. 4/ch. 5	R/W	00000000 <sub>B</sub>
004B <sub>H</sub>	EIC30	External interrupt circuit control register ch. 6/ch. 7	R/W	00000000 <sub>B</sub>
004C <sub>H</sub> , 004D <sub>H</sub>	—	(Disabled)	—	—
004E <sub>H</sub>	LVDR	LVDR reset voltage selection ID register	R/W	00000000 <sub>B</sub>
004F <sub>H</sub>	—	(Disabled)	—	—
0050 <sub>H</sub>	SCR	LIN-UART serial control register	R/W	00000000 <sub>B</sub>
0051 <sub>H</sub>	SMR	LIN-UART serial mode register	R/W	00000000 <sub>B</sub>
0052 <sub>H</sub>	SSR	LIN-UART serial status register	R/W	00001000 <sub>B</sub>
0053 <sub>H</sub>	RDR	LIN-UART receive data register	R/W	00000000 <sub>B</sub>
	TDR	LIN-UART transmit data register	R/W	00000000 <sub>B</sub>
0054 <sub>H</sub>	ESCR	LIN-UART extended status control register	R/W	00000100 <sub>B</sub>
0055 <sub>H</sub>	ECCR	LIN-UART extended communication control register	R/W	000000XX <sub>B</sub>
0056 <sub>H</sub> to 006B <sub>H</sub>	—	(Disabled)	—	—
006C <sub>H</sub>	ADC1	8/10-bit A/D converter control register 1	R/W	00000000 <sub>B</sub>
006D <sub>H</sub>	ADC2	8/10-bit A/D converter control register 2	R/W	00000000 <sub>B</sub>
006E <sub>H</sub>	ADDH	8/10-bit A/D converter data register (upper)	R/W	00000000 <sub>B</sub>
006F <sub>H</sub>	ADDL	8/10-bit A/D converter data register (lower)	R/W	00000000 <sub>B</sub>
0070 <sub>H</sub>	—	(Disabled)	—	—
0071 <sub>H</sub>	FSR2	Flash memory status register 2	R/W	00000000 <sub>B</sub>
0072 <sub>H</sub>	FSR	Flash memory status register	R/W	000X0000 <sub>B</sub>
0073 <sub>H</sub>	SWRE0	Flash memory sector write control register 0	R/W	00000000 <sub>B</sub>
0074 <sub>H</sub>	FSR3	Flash memory status register 3	R	000XXXXX <sub>B</sub>
0075 <sub>H</sub>	FSR4	Flash memory status register 4	R/W	00000000 <sub>B</sub>
0076 <sub>H</sub>	WREN	Wild register address compare enable register	R/W	00000000 <sub>B</sub>
0077 <sub>H</sub>	WROR	Wild register data test setting register	R/W	00000000 <sub>B</sub>
0078 <sub>H</sub>	—	Mirror of register bank pointer (RP) and direct bank pointer (DP)	—	—
0079 <sub>H</sub>	ILR0	Interrupt level setting register 0	R/W	11111111 <sub>B</sub>
007A <sub>H</sub>	ILR1	Interrupt level setting register 1	R/W	11111111 <sub>B</sub>
007B <sub>H</sub>	ILR2	Interrupt level setting register 2	R/W	11111111 <sub>B</sub>
007C <sub>H</sub>	ILR3	Interrupt level setting register 3	R/W	11111111 <sub>B</sub>
007D <sub>H</sub>	ILR4	Interrupt level setting register 4	R/W	11111111 <sub>B</sub>
007E <sub>H</sub>	ILR5	Interrupt level setting register 5	R/W	11111111 <sub>B</sub>
007F <sub>H</sub>	—	(Disabled)	—	—
0F80 <sub>H</sub>	WRARH0	Wild register address setting register (upper) ch. 0	R/W	00000000 <sub>B</sub>
0F81 <sub>H</sub>	WRARL0	Wild register address setting register (lower) ch. 0	R/W	00000000 <sub>B</sub>
0F82 <sub>H</sub>	WRDR0	Wild register data setting register ch. 0	R/W	00000000 <sub>B</sub>





Address	Register abbreviation	Register name	R/W	Initial value
0F83 <sub>H</sub>	WRARH1	Wild register address setting register (upper) ch. 1	R/W	00000000 <sub>B</sub>
0F84 <sub>H</sub>	WRARL1	Wild register address setting register (lower) ch. 1	R/W	00000000 <sub>B</sub>
0F85 <sub>H</sub>	WRDR1	Wild register data setting register ch. 1	R/W	00000000 <sub>B</sub>
0F86 <sub>H</sub>	WRARH2	Wild register address setting register (upper) ch. 2	R/W	00000000 <sub>B</sub>
0F87 <sub>H</sub>	WRARL2	Wild register address setting register (lower) ch. 2	R/W	00000000 <sub>B</sub>
0F88 <sub>H</sub>	WRDR2	Wild register data setting register ch. 2	R/W	00000000 <sub>B</sub>
0F89 <sub>H</sub> to 0F91 <sub>H</sub>	—	(Disabled)	—	—
0F92 <sub>H</sub>	T01CR0	8/16-bit composite timer 01 status control register 0	R/W	00000000 <sub>B</sub>
0F93 <sub>H</sub>	T00CR0	8/16-bit composite timer 00 status control register 0	R/W	00000000 <sub>B</sub>
0F94 <sub>H</sub>	T01DR	8/16-bit composite timer 01 data register	R/W	00000000 <sub>B</sub>
0F95 <sub>H</sub>	T00DR	8/16-bit composite timer 00 data register	R/W	00000000 <sub>B</sub>
0F96 <sub>H</sub>	TMCR0	8/16-bit composite timer 00/01 timer mode control register	R/W	00000000 <sub>B</sub>
0F97 <sub>H</sub>	T11CR0	8/16-bit composite timer 11 status control register 0	R/W	00000000 <sub>B</sub>
0F98 <sub>H</sub>	T10CR0	8/16-bit composite timer 10 status control register 0	R/W	00000000 <sub>B</sub>
0F99 <sub>H</sub>	T11DR	8/16-bit composite timer 11 data register	R/W	00000000 <sub>B</sub>
0F9A <sub>H</sub>	T10DR	8/16-bit composite timer 10 data register	R/W	00000000 <sub>B</sub>
0F9B <sub>H</sub>	TMCR1	8/16-bit composite timer 10/11 timer mode control register	R/W	00000000 <sub>B</sub>
0F9C <sub>H</sub> to 0FBB <sub>H</sub>	—	(Disabled)	—	—
0FBC <sub>H</sub>	BGR1	LIN-UART baud rate generator register 1	R/W	00000000 <sub>B</sub>
0FBD <sub>H</sub>	BGR0	LIN-UART baud rate generator register 0	R/W	00000000 <sub>B</sub>
0FBE <sub>H</sub> to 0FC2 <sub>H</sub>	—	(Disabled)	—	—
0FC3 <sub>H</sub>	AIDRL	A/D input disable register (lower)	R/W	00000000 <sub>B</sub>
0FC4 <sub>H</sub> to 0FE3 <sub>H</sub>	—	(Disabled)	—	—
0FE4 <sub>H</sub>	CRTH	Main CR clock trimming register (upper)	R/W	000XXXXX <sub>B</sub>
0FE5 <sub>H</sub>	CRTL	Main CR clock trimming register (lower)	R/W	000XXXXX <sub>B</sub>
0FE6 <sub>H</sub>	—	(Disabled)	—	—
0FE7 <sub>H</sub>	CRTDA	Main CR clock temperature dependent adjustment register	R/W	000XXXXX <sub>B</sub>
0FE8 <sub>H</sub>	SYSC	System configuration register	R/W	11000011 <sub>B</sub>
0FE9 <sub>H</sub>	CMCR	Clock monitoring control register	R/W	00000000 <sub>B</sub>
0FEA <sub>H</sub>	CMDR	Clock monitoring data register	R	00000000 <sub>B</sub>



Address	Register abbreviation	Register name	R/W	Initial value
0FEB <sub>H</sub>	WDTH	Watchdog timer selection ID register (upper)	R	XXXXXXXX <sub>B</sub>
0FEC <sub>H</sub>	WDTL	Watchdog timer selection ID register (lower)	R	XXXXXXXX <sub>B</sub>
0FED <sub>H</sub> to 0FFF <sub>H</sub>	—	(Disabled)	—	—

• R/W access symbols

R/W : Readable / Writable

R : Read only

• Initial value symbols

0 : The initial value of this bit is “0”.

1 : The initial value of this bit is “1”.

X : The initial value of this bit is undefined.

Note: Do not write to an address that is “(Disabled)”. If a “(Disabled)” address is read, an indeterminate value is returned.



**19. I/O Map (MB95570H Series)**

Address	Register abbreviation	Register name	R/W	Initial value
0000 <sub>H</sub>	PDR0	Port 0 data register	R/W	00000000 <sub>B</sub>
0001 <sub>H</sub>	DDR0	Port 0 direction register	R/W	00000000 <sub>B</sub>
0002 <sub>H</sub>	PDR1	Port 1 data register	R/W	00000000 <sub>B</sub>
0003 <sub>H</sub>	DDR1	Port 1 direction register	R/W	00000000 <sub>B</sub>
0004 <sub>H</sub>	—	(Disabled)	—	—
0005 <sub>H</sub>	WATR	Oscillation stabilization wait time setting register	R/W	11111111 <sub>B</sub>
0006 <sub>H</sub>	PLLC	PLL control register	R/W	000X0000 <sub>B</sub>
0007 <sub>H</sub>	SYCC	System clock control register	R/W	XXX11011 <sub>B</sub>
0008 <sub>H</sub>	STBC	Standby control register	R/W	00000000 <sub>B</sub>
0009 <sub>H</sub>	RSRR	Reset source register	R/W	000XXXXX <sub>B</sub>
000A <sub>H</sub>	TBTC	Time-base timer control register	R/W	00000000 <sub>B</sub>
000B <sub>H</sub>	WPCR	Watch prescaler control register	R/W	00000000 <sub>B</sub>
000C <sub>H</sub>	WDTC	Watchdog timer control register	R/W	00XX0000 <sub>B</sub>
000D <sub>H</sub>	SYCC2	System clock control register 2	R/W	XXXX0011 <sub>B</sub>
000E <sub>H</sub>	STBC2	Standby control register 2	R/W	00000000 <sub>B</sub>
000F <sub>H</sub> to 0027 <sub>H</sub>	—	(Disabled)	—	—
0028 <sub>H</sub>	PDRF	Port F data register	R/W	00000000 <sub>B</sub>
0029 <sub>H</sub>	DDRF	Port F direction register	R/W	00000000 <sub>B</sub>
002A <sub>H</sub> , 002B <sub>H</sub>	—	(Disabled)	—	—
002C <sub>H</sub>	PUL0	Port 0 pull-up register	R/W	00000000 <sub>B</sub>
002D <sub>H</sub> to 0035 <sub>H</sub>	—	(Disabled)	—	—
0036 <sub>H</sub>	T01CR1	8/16-bit composite timer 01 status control register 1	R/W	00000000 <sub>B</sub>
0037 <sub>H</sub>	T00CR1	8/16-bit composite timer 00 status control register 1	R/W	00000000 <sub>B</sub>
0038 <sub>H</sub> to 0049 <sub>H</sub>	—	(Disabled)	—	—
004A <sub>H</sub>	EIC20	External interrupt circuit control register ch. 4/ch. 5	R/W	00000000 <sub>B</sub>
004B <sub>H</sub>	EIC30	External interrupt circuit control register ch. 6/ch. 7	R/W	00000000 <sub>B</sub>
004C <sub>H</sub> , 004D <sub>H</sub>	—	(Disabled)	—	—
004E <sub>H</sub>	LVDR	LVDR reset voltage selection ID register	R/W	00000000 <sub>B</sub>
004F <sub>H</sub> to 006B <sub>H</sub>	—	(Disabled)	—	—



Address	Register abbreviation	Register name	R/W	Initial value
006C <sub>H</sub>	ADC1	8/10-bit A/D converter control register 1	R/W	00000000 <sub>B</sub>
006D <sub>H</sub>	ADC2	8/10-bit A/D converter control register 2	R/W	00000000 <sub>B</sub>
006E <sub>H</sub>	ADDH	8/10-bit A/D converter data register (upper)	R/W	00000000 <sub>B</sub>
006F <sub>H</sub>	ADDL	8/10-bit A/D converter data register (lower)	R/W	00000000 <sub>B</sub>
0070 <sub>H</sub>	—	(Disabled)	—	—
0071 <sub>H</sub>	FSR2	Flash memory status register 2	R/W	00000000 <sub>B</sub>
0072 <sub>H</sub>	FSR	Flash memory status register	R/W	000X0000 <sub>B</sub>
0073 <sub>H</sub>	SWRE0	Flash memory sector write control register 0	R/W	00000000 <sub>B</sub>
0074 <sub>H</sub>	FSR3	Flash memory status register 3	R	000XXXXX <sub>B</sub>
0075 <sub>H</sub>	FSR4	Flash memory status register 4	R/W	00000000 <sub>B</sub>
0076 <sub>H</sub>	WREN	Wild register address compare enable register	R/W	00000000 <sub>B</sub>
0077 <sub>H</sub>	WROR	Wild register data test setting register	R/W	00000000 <sub>B</sub>
0078 <sub>H</sub>	—	Mirror of register bank pointer (RP) and direct bank pointer (DP)	—	—
0079 <sub>H</sub>	ILR0	Interrupt level setting register 0	R/W	11111111 <sub>B</sub>
007A <sub>H</sub>	ILR1	Interrupt level setting register 1	R/W	11111111 <sub>B</sub>
007B <sub>H</sub> , 007C <sub>H</sub>	—	(Disabled)	—	—
007D <sub>H</sub>	ILR4	Interrupt level setting register 4	R/W	11111111 <sub>B</sub>
007E <sub>H</sub>	ILR5	Interrupt level setting register 5	R/W	11111111 <sub>B</sub>
007F <sub>H</sub>	—	(Disabled)	—	—
0F80 <sub>H</sub>	WRARH0	Wild register address setting register (upper) ch. 0	R/W	00000000 <sub>B</sub>
0F81 <sub>H</sub>	WRARL0	Wild register address setting register (lower) ch. 0	R/W	00000000 <sub>B</sub>
0F82 <sub>H</sub>	WRDR0	Wild register data setting register ch. 0	R/W	00000000 <sub>B</sub>
0F83 <sub>H</sub>	WRARH1	Wild register address setting register (upper) ch. 1	R/W	00000000 <sub>B</sub>
0F84 <sub>H</sub>	WRARL1	Wild register address setting register (lower) ch. 1	R/W	00000000 <sub>B</sub>
0F85 <sub>H</sub>	WRDR1	Wild register data setting register ch. 1	R/W	00000000 <sub>B</sub>
0F86 <sub>H</sub>	WRARH2	Wild register address setting register (upper) ch. 2	R/W	00000000 <sub>B</sub>
0F87 <sub>H</sub>	WRARL2	Wild register address setting register (lower) ch. 2	R/W	00000000 <sub>B</sub>
0F88 <sub>H</sub>	WRDR2	Wild register data setting register ch. 2	R/W	00000000 <sub>B</sub>
0F89 <sub>H</sub> to 0F91 <sub>H</sub>	—	(Disabled)	—	—
0F92 <sub>H</sub>	T01CR0	8/16-bit composite timer 01 status control register 0	R/W	00000000 <sub>B</sub>
0F93 <sub>H</sub>	T00CR0	8/16-bit composite timer 00 status control register 0	R/W	00000000 <sub>B</sub>
0F94 <sub>H</sub>	T01DR	8/16-bit composite timer 01 data register	R/W	00000000 <sub>B</sub>
0F95 <sub>H</sub>	T00DR	8/16-bit composite timer 00 data register	R/W	00000000 <sub>B</sub>
0F96 <sub>H</sub>	TMCR0	8/16-bit composite timer 00/01 timer mode control register	R/W	00000000 <sub>B</sub>
0F97 <sub>H</sub> to 0FC2 <sub>H</sub>	—	(Disabled)	—	—



Address	Register abbreviation	Register name	R/W	Initial value
0FC3 <sub>H</sub>	AIDRL	A/D input disable register (lower)	R/W	00000000 <sub>B</sub>
0FC4 <sub>H</sub> to 0FE3 <sub>H</sub>	—	(Disabled)	—	—
0FE4 <sub>H</sub>	CRTH	Main CR clock trimming register (upper)	R/W	000XXXXX <sub>B</sub>
0FE5 <sub>H</sub>	CRTL	Main CR clock trimming register (lower)	R/W	000XXXXX <sub>B</sub>
0FE6 <sub>H</sub>	—	(Disabled)	—	—
0FE7 <sub>H</sub>	CRTDA	Main CR clock temperature dependent adjustment register	R/W	000XXXXX <sub>B</sub>
0FE8 <sub>H</sub>	SYSC	System configuration register	R/W	11000011 <sub>B</sub>
0FE9 <sub>H</sub>	CMCR	Clock monitoring control register	R/W	00000000 <sub>B</sub>
0FEA <sub>H</sub>	CMDR	Clock monitoring data register	R	00000000 <sub>B</sub>
0FEB <sub>H</sub>	WDTH	Watchdog timer selection ID register (upper)	R	XXXXXXXX <sub>B</sub>
0FEC <sub>H</sub>	WDTL	Watchdog timer selection ID register (lower)	R	XXXXXXXX <sub>B</sub>
0FED <sub>H</sub> to 0FFF <sub>H</sub>	—	(Disabled)	—	—

• R/W access symbols

R/W : Readable / Writable

R : Read only

• Initial value symbols

0 : The initial value of this bit is “0”.

1 : The initial value of this bit is “1”.

X : The initial value of this bit is undefined.

Note: Do not write to an address that is “(Disabled)”. If a “(Disabled)” address is read, an indeterminate value is returned.



**20. I/O Map (MB95580H Series)**

Address	Register abbreviation	Register name	R/W	Initial value
0000 <sub>H</sub>	PDR0	Port 0 data register	R/W	00000000 <sub>B</sub>
0001 <sub>H</sub>	DDR0	Port 0 direction register	R/W	00000000 <sub>B</sub>
0002 <sub>H</sub>	PDR1	Port 1 data register	R/W	00000000 <sub>B</sub>
0003 <sub>H</sub>	DDR1	Port 1 direction register	R/W	00000000 <sub>B</sub>
0004 <sub>H</sub>	—	(Disabled)	—	—
0005 <sub>H</sub>	WATR	Oscillation stabilization wait time setting register	R/W	11111111 <sub>B</sub>
0006 <sub>H</sub>	PLLC	PLL control register	R/W	000X0000 <sub>B</sub>
0007 <sub>H</sub>	SYCC	System clock control register	R/W	XXX11011 <sub>B</sub>
0008 <sub>H</sub>	STBC	Standby control register	R/W	00000000 <sub>B</sub>
0009 <sub>H</sub>	RSRR	Reset source register	R/W	000XXXXX <sub>B</sub>
000A <sub>H</sub>	TBTC	Time-base timer control register	R/W	00000000 <sub>B</sub>
000B <sub>H</sub>	WPCR	Watch prescaler control register	R/W	00000000 <sub>B</sub>
000C <sub>H</sub>	WDTC	Watchdog timer control register	R/W	00XX0000 <sub>B</sub>
000D <sub>H</sub>	SYCC2	System clock control register 2	R/W	XXXX0011 <sub>B</sub>
000E <sub>H</sub>	STBC2	Standby control register 2	R/W	00000000 <sub>B</sub>
000F <sub>H</sub> to 0027 <sub>H</sub>	—	(Disabled)	—	—
0028 <sub>H</sub>	PDRF	Port F data register	R/W	00000000 <sub>B</sub>
0029 <sub>H</sub>	DDRF	Port F direction register	R/W	00000000 <sub>B</sub>
002A <sub>H</sub>	PDRG	Port G data register	R/W	00000000 <sub>B</sub>
002B <sub>H</sub>	DDRG	Port G direction register	R/W	00000000 <sub>B</sub>
002C <sub>H</sub>	PUL0	Port 0 pull-up register	R/W	00000000 <sub>B</sub>
002D <sub>H</sub> to 0034 <sub>H</sub>	—	(Disabled)	—	—
0035 <sub>H</sub>	PULG	Port G pull-up register	R/W	00000000 <sub>B</sub>
0036 <sub>H</sub>	T01CR1	8/16-bit composite timer 01 status control register 1	R/W	00000000 <sub>B</sub>
0037 <sub>H</sub>	T00CR1	8/16-bit composite timer 00 status control register 1	R/W	00000000 <sub>B</sub>
0038 <sub>H</sub> to 0048 <sub>H</sub>	—	(Disabled)	—	—
0049 <sub>H</sub>	EIC10	External interrupt circuit control register ch. 2/ch. 3	R/W	00000000 <sub>B</sub>
004A <sub>H</sub>	EIC20	External interrupt circuit control register ch. 4/ch. 5	R/W	00000000 <sub>B</sub>
004B <sub>H</sub>	EIC30	External interrupt circuit control register ch. 6/ch. 7	R/W	00000000 <sub>B</sub>
004C <sub>H</sub> , 004D <sub>H</sub>	—	(Disabled)	—	—
004E <sub>H</sub>	LVDR	LVDR reset voltage selection ID register	R/W	00000000 <sub>B</sub>
004F <sub>H</sub>	—	(Disabled)	—	—



Address	Register abbreviation	Register name	R/W	Initial value
0050 <sub>H</sub>	SCR	LIN-UART serial control register	R/W	00000000 <sub>B</sub>
0051 <sub>H</sub>	SMR	LIN-UART serial mode register	R/W	00000000 <sub>B</sub>
0052 <sub>H</sub>	SSR	LIN-UART serial status register	R/W	00001000 <sub>B</sub>
0053 <sub>H</sub>	RDR	LIN-UART receive data register	R/W	00000000 <sub>B</sub>
	TDR	LIN-UART transmit data register	R/W	00000000 <sub>B</sub>
0054 <sub>H</sub>	ESCR	LIN-UART extended status control register	R/W	00000100 <sub>B</sub>
0055 <sub>H</sub>	ECCR	LIN-UART extended communication control register	R/W	000000XX <sub>B</sub>
0056 <sub>H</sub> to 006B <sub>H</sub>	—	(Disabled)	—	—
006C <sub>H</sub>	ADC1	8/10-bit A/D converter control register 1	R/W	00000000 <sub>B</sub>
006D <sub>H</sub>	ADC2	8/10-bit A/D converter control register 2	R/W	00000000 <sub>B</sub>
006E <sub>H</sub>	ADDH	8/10-bit A/D converter data register (upper)	R/W	00000000 <sub>B</sub>
006F <sub>H</sub>	ADDL	8/10-bit A/D converter data register (lower)	R/W	00000000 <sub>B</sub>
0070 <sub>H</sub>	—	(Disabled)	—	—
0071 <sub>H</sub>	FSR2	Flash memory status register 2	R/W	00000000 <sub>B</sub>
0072 <sub>H</sub>	FSR	Flash memory status register	R/W	000X0000 <sub>B</sub>
0073 <sub>H</sub>	SWRE0	Flash memory sector write control register 0	R/W	00000000 <sub>B</sub>
0074 <sub>H</sub>	FSR3	Flash memory status register 3	R	000XXXXX <sub>B</sub>
0075 <sub>H</sub>	FSR4	Flash memory status register 4	R/W	00000000 <sub>B</sub>
0076 <sub>H</sub>	WREN	Wild register address compare enable register	R/W	00000000 <sub>B</sub>
0077 <sub>H</sub>	WROR	Wild register data test setting register	R/W	00000000 <sub>B</sub>
0078 <sub>H</sub>	—	Mirror of register bank pointer (RP) and direct bank pointer (DP)	—	—
0079 <sub>H</sub>	ILR0	Interrupt level setting register 0	R/W	11111111 <sub>B</sub>
007A <sub>H</sub>	ILR1	Interrupt level setting register 1	R/W	11111111 <sub>B</sub>
007B <sub>H</sub>	ILR2	Interrupt level setting register 2	R/W	11111111 <sub>B</sub>
007C <sub>H</sub>	—	(Disabled)	—	—
007D <sub>H</sub>	ILR4	Interrupt level setting register 4	R/W	11111111 <sub>B</sub>
007E <sub>H</sub>	ILR5	Interrupt level setting register 5	R/W	11111111 <sub>B</sub>
007F <sub>H</sub>	—	(Disabled)	—	—
0F80 <sub>H</sub>	WRARH0	Wild register address setting register (upper) ch. 0	R/W	00000000 <sub>B</sub>
0F81 <sub>H</sub>	WRARL0	Wild register address setting register (lower) ch. 0	R/W	00000000 <sub>B</sub>
0F82 <sub>H</sub>	WRDR0	Wild register data setting register ch. 0	R/W	00000000 <sub>B</sub>
0F83 <sub>H</sub>	WRARH1	Wild register address setting register (upper) ch. 1	R/W	00000000 <sub>B</sub>
0F84 <sub>H</sub>	WRARL1	Wild register address setting register (lower) ch. 1	R/W	00000000 <sub>B</sub>
0F85 <sub>H</sub>	WRDR1	Wild register data setting register ch. 1	R/W	00000000 <sub>B</sub>
0F86 <sub>H</sub>	WRARH2	Wild register address setting register (upper) ch. 2	R/W	00000000 <sub>B</sub>
0F87 <sub>H</sub>	WRARL2	Wild register address setting register (lower) ch. 2	R/W	00000000 <sub>B</sub>
0F88 <sub>H</sub>	WRDR2	Wild register data setting register ch. 2	R/W	00000000 <sub>B</sub>



Address	Register abbreviation	Register name	R/W	Initial value
0F89 <sub>H</sub> to 0F91 <sub>H</sub>	—	(Disabled)	—	—
0F92 <sub>H</sub>	T01CR0	8/16-bit composite timer 01 status control register 0	R/W	00000000 <sub>B</sub>
0F93 <sub>H</sub>	T00CR0	8/16-bit composite timer 00 status control register 0	R/W	00000000 <sub>B</sub>
0F94 <sub>H</sub>	T01DR	8/16-bit composite timer 01 data register	R/W	00000000 <sub>B</sub>
0F95 <sub>H</sub>	T00DR	8/16-bit composite timer 00 data register	R/W	00000000 <sub>B</sub>
0F96 <sub>H</sub>	TMCR0	8/16-bit composite timer 00/01 timer mode control register	R/W	00000000 <sub>B</sub>
0F97 <sub>H</sub> to 0FBB <sub>H</sub>	—	(Disabled)	—	—
0FBC <sub>H</sub>	BGR1	LIN-UART baud rate generator register 1	R/W	00000000 <sub>B</sub>
0FBD <sub>H</sub>	BGR0	LIN-UART baud rate generator register 0	R/W	00000000 <sub>B</sub>
0FBE <sub>H</sub> to 0FC2 <sub>H</sub>	—	(Disabled)	—	—
0FC3 <sub>H</sub>	AIDRL	A/D input disable register (lower)	R/W	00000000 <sub>B</sub>
0FC4 <sub>H</sub> to 0FE3 <sub>H</sub>	—	(Disabled)	—	—
0FE4 <sub>H</sub>	CRTH	Main CR clock trimming register (upper)	R/W	000XXXXX <sub>B</sub>
0FE5 <sub>H</sub>	CRTL	Main CR clock trimming register (lower)	R/W	000XXXXX <sub>B</sub>
0FE6 <sub>H</sub>	—	(Disabled)	—	—
0FE7 <sub>H</sub>	CRTDA	Main CR clock temperature dependent adjustment register	R/W	000XXXXX <sub>B</sub>
0FE8 <sub>H</sub>	SYSC	System configuration register	R/W	11000011 <sub>B</sub>
0FE9 <sub>H</sub>	CMCR	Clock monitoring control register	R/W	00000000 <sub>B</sub>
0FEA <sub>H</sub>	CMDR	Clock monitoring data register	R	00000000 <sub>B</sub>
0FEB <sub>H</sub>	WDTH	Watchdog timer selection ID register (upper)	R	XXXXXXXX <sub>B</sub>
0FEC <sub>H</sub>	WDTL	Watchdog timer selection ID register (lower)	R	XXXXXXXX <sub>B</sub>
0FED <sub>H</sub> to 0FFF <sub>H</sub>	—	(Disabled)	—	—

• R/W access symbols

R/W : Readable / Writable

R : Read only

• Initial value symbols

0 : The initial value of this bit is "0".

1 : The initial value of this bit is "1".

X : The initial value of this bit is undefined.

Note: Do not write to an address that is "(Disabled)". If a "(Disabled)" address is read, an indeterminate value is returned.





**21. Interrupt Source Table (MB95560H Series)**

Interrupt source	Interrupt request number	Vector table address		Bit name of interrupt level setting register	Priority order of interrupt sources of the same level (occurring simultaneously)
		Upper	Lower		
External interrupt ch. 4	IRQ00	FFFA <sub>H</sub>	FFFB <sub>H</sub>	L00 [1:0]	<div style="text-align: center;">High</div> <div style="text-align: center;">↑</div> <div style="text-align: center;">↓</div> <div style="text-align: center;">Low</div>
External interrupt ch. 5	IRQ01	FFF8 <sub>H</sub>	FFF9 <sub>H</sub>	L01 [1:0]	
External interrupt ch. 2	IRQ02	FFF6 <sub>H</sub>	FFF7 <sub>H</sub>	L02 [1:0]	
External interrupt ch. 6					
External interrupt ch. 3	IRQ03	FFF4 <sub>H</sub>	FFF5 <sub>H</sub>	L03 [1:0]	
External interrupt ch. 7					
—	IRQ04	FFF2 <sub>H</sub>	FFF3 <sub>H</sub>	L04 [1:0]	
8/16-bit composite timer ch. 0 (lower)	IRQ05	FFF0 <sub>H</sub>	FFF1 <sub>H</sub>	L05 [1:0]	
8/16-bit composite timer ch. 0 (upper)	IRQ06	FFEE <sub>H</sub>	FFEF <sub>H</sub>	L06 [1:0]	
LIN-UART (reception)	IRQ07	FFEC <sub>H</sub>	FFED <sub>H</sub>	L07 [1:0]	
LIN-UART (transmission)	IRQ08	FFEA <sub>H</sub>	FFEB <sub>H</sub>	L08 [1:0]	
—	IRQ09	FFE8 <sub>H</sub>	FFE9 <sub>H</sub>	L09 [1:0]	
—	IRQ10	FFE6 <sub>H</sub>	FFE7 <sub>H</sub>	L10 [1:0]	
—	IRQ11	FFE4 <sub>H</sub>	FFE5 <sub>H</sub>	L11 [1:0]	
—	IRQ12	FFE2 <sub>H</sub>	FFE3 <sub>H</sub>	L12 [1:0]	
—	IRQ13	FFE0 <sub>H</sub>	FFE1 <sub>H</sub>	L13 [1:0]	
8/16-bit composite timer ch. 1 (upper)	IRQ14	FFDE <sub>H</sub>	FFDF <sub>H</sub>	L14 [1:0]	
—	IRQ15	FFDC <sub>H</sub>	FFDD <sub>H</sub>	L15 [1:0]	
—	IRQ16	FFDA <sub>H</sub>	FFDB <sub>H</sub>	L16 [1:0]	
—	IRQ17	FFD8 <sub>H</sub>	FFD9 <sub>H</sub>	L17 [1:0]	
8/10-bit A/D converter	IRQ18	FFD6 <sub>H</sub>	FFD7 <sub>H</sub>	L18 [1:0]	
Time-base timer	IRQ19	FFD4 <sub>H</sub>	FFD5 <sub>H</sub>	L19 [1:0]	
Watch prescaler	IRQ20	FFD2 <sub>H</sub>	FFD3 <sub>H</sub>	L20 [1:0]	
—	IRQ21	FFD0 <sub>H</sub>	FFD1 <sub>H</sub>	L21 [1:0]	
8/16-bit composite timer ch. 1 (lower)	IRQ22	FFCE <sub>H</sub>	FFCF <sub>H</sub>	L22 [1:0]	
Flash memory	IRQ23	FFCC <sub>H</sub>	FFCD <sub>H</sub>	L23 [1:0]	



**22. Interrupt Source Table (MB95570H Series)**

Interrupt source	Interrupt request number	Vector table address		Bit name of interrupt level setting register	Priority order of interrupt sources of the same level (occurring simultaneously)
		Upper	Lower		
External interrupt ch. 4	IRQ00	FFFA <sub>H</sub>	FFFB <sub>H</sub>	L00 [1:0]	<div style="text-align: center;">High</div> <div style="text-align: center;">↑</div> <div style="text-align: center;">↓</div> <div style="text-align: center;">Low</div>
—	IRQ01	FFF8 <sub>H</sub>	FFF9 <sub>H</sub>	L01 [1:0]	
—	IRQ02	FFF6 <sub>H</sub>	FFF7 <sub>H</sub>	L02 [1:0]	
External interrupt ch. 6					
—	IRQ03	FFF4 <sub>H</sub>	FFF5 <sub>H</sub>	L03 [1:0]	
—					
—					
—	IRQ04	FFF2 <sub>H</sub>	FFF3 <sub>H</sub>	L04 [1:0]	
8/16-bit composite timer ch. 0 (lower)	IRQ05	FFF0 <sub>H</sub>	FFF1 <sub>H</sub>	L05 [1:0]	
8/16-bit composite timer ch. 0 (upper)	IRQ06	FFEE <sub>H</sub>	FFEF <sub>H</sub>	L06 [1:0]	
—	IRQ07	FFEC <sub>H</sub>	FFED <sub>H</sub>	L07 [1:0]	
—	IRQ08	FFEA <sub>H</sub>	FFEB <sub>H</sub>	L08 [1:0]	
—	IRQ09	FFE8 <sub>H</sub>	FFE9 <sub>H</sub>	L09 [1:0]	
—	IRQ10	FFE6 <sub>H</sub>	FFE7 <sub>H</sub>	L10 [1:0]	
—	IRQ11	FFE4 <sub>H</sub>	FFE5 <sub>H</sub>	L11 [1:0]	
—	IRQ12	FFE2 <sub>H</sub>	FFE3 <sub>H</sub>	L12 [1:0]	
—	IRQ13	FFE0 <sub>H</sub>	FFE1 <sub>H</sub>	L13 [1:0]	
—	IRQ14	FFDE <sub>H</sub>	FFDF <sub>H</sub>	L14 [1:0]	
—	IRQ15	FFDC <sub>H</sub>	FFDD <sub>H</sub>	L15 [1:0]	
—	IRQ16	FFDA <sub>H</sub>	FFDB <sub>H</sub>	L16 [1:0]	
—	IRQ17	FFD8 <sub>H</sub>	FFD9 <sub>H</sub>	L17 [1:0]	
8/10-bit A/D converter	IRQ18	FFD6 <sub>H</sub>	FFD7 <sub>H</sub>	L18 [1:0]	
Time-base timer	IRQ19	FFD4 <sub>H</sub>	FFD5 <sub>H</sub>	L19 [1:0]	
Watch prescaler	IRQ20	FFD2 <sub>H</sub>	FFD3 <sub>H</sub>	L20 [1:0]	
—	IRQ21	FFD0 <sub>H</sub>	FFD1 <sub>H</sub>	L21 [1:0]	
—	IRQ22	FFCE <sub>H</sub>	FFCF <sub>H</sub>	L22 [1:0]	
Flash memory	IRQ23	FFCC <sub>H</sub>	FFCD <sub>H</sub>	L23 [1:0]	



23. Interrupt Source Table (MB95580H Series)

Interrupt source	Interrupt request number	Vector table address		Bit name of interrupt level setting register	Priority order of interrupt sources of the same level (occurring simultaneously)
		Upper	Lower		
External interrupt ch. 4	IRQ00	FFFA <sub>H</sub>	FFFB <sub>H</sub>	L00 [1:0]	High  Low
External interrupt ch. 5	IRQ01	FFF8 <sub>H</sub>	FFF9 <sub>H</sub>	L01 [1:0]	
External interrupt ch. 2	IRQ02	FFF6 <sub>H</sub>	FFF7 <sub>H</sub>	L02 [1:0]	
External interrupt ch. 6					
External interrupt ch. 3	IRQ03	FFF4 <sub>H</sub>	FFF5 <sub>H</sub>	L03 [1:0]	
External interrupt ch. 7					
—	IRQ04	FFF2 <sub>H</sub>	FFF3 <sub>H</sub>	L04 [1:0]	
8/16-bit composite timer ch. 0 (lower)	IRQ05	FFF0 <sub>H</sub>	FFF1 <sub>H</sub>	L05 [1:0]	
8/16-bit composite timer ch. 0 (upper)	IRQ06	FFEE <sub>H</sub>	FFEF <sub>H</sub>	L06 [1:0]	
LIN-UART (reception)	IRQ07	FFEC <sub>H</sub>	FFED <sub>H</sub>	L07 [1:0]	
LIN-UART (transmission)	IRQ08	FFEA <sub>H</sub>	FFEB <sub>H</sub>	L08 [1:0]	
—	IRQ09	FFE8 <sub>H</sub>	FFE9 <sub>H</sub>	L09 [1:0]	
—	IRQ10	FFE6 <sub>H</sub>	FFE7 <sub>H</sub>	L10 [1:0]	
—	IRQ11	FFE4 <sub>H</sub>	FFE5 <sub>H</sub>	L11 [1:0]	
—	IRQ12	FFE2 <sub>H</sub>	FFE3 <sub>H</sub>	L12 [1:0]	
—	IRQ13	FFE0 <sub>H</sub>	FFE1 <sub>H</sub>	L13 [1:0]	
—	IRQ14	FFDE <sub>H</sub>	FFDF <sub>H</sub>	L14 [1:0]	
—	IRQ15	FFDC <sub>H</sub>	FFDD <sub>H</sub>	L15 [1:0]	
—	IRQ16	FFDA <sub>H</sub>	FFDB <sub>H</sub>	L16 [1:0]	
—	IRQ17	FFD8 <sub>H</sub>	FFD9 <sub>H</sub>	L17 [1:0]	
8/10-bit A/D converter	IRQ18	FFD6 <sub>H</sub>	FFD7 <sub>H</sub>	L18 [1:0]	
Time-base timer	IRQ19	FFD4 <sub>H</sub>	FFD5 <sub>H</sub>	L19 [1:0]	
Watch prescaler	IRQ20	FFD2 <sub>H</sub>	FFD3 <sub>H</sub>	L20 [1:0]	
—	IRQ21	FFD0 <sub>H</sub>	FFD1 <sub>H</sub>	L21 [1:0]	
—	IRQ22	FFCE <sub>H</sub>	FFCF <sub>H</sub>	L22 [1:0]	
Flash memory	IRQ23	FFCC <sub>H</sub>	FFCD <sub>H</sub>	L23 [1:0]	

## 24. Electrical Characteristics

### 24.1 Absolute Maximum Ratings

Parameter	Symbol	Rating		Unit	Remarks
		Min	Max		
Power supply voltage*1	$V_{CC}$	$V_{SS} - 0.3$	$V_{SS} + 6$	V	
Input voltage*1	$V_I$	$V_{SS} - 0.3$	$V_{SS} + 6$	V	*2
Output voltage*1	$V_O$	$V_{SS} - 0.3$	$V_{SS} + 6$	V	*2
Maximum clamp current	$I_{CLAMP}$	-2	+2	mA	Applicable to specific pins*3
Total maximum clamp current	$\sum  I_{CLAMP} $	—	20	mA	Applicable to specific pins*3
“L” level maximum output current	$I_{OL}$	—	15	mA	
“L” level average current	$I_{OLAV1}$	—	4	mA	Other than P00 to P03, P05 to P07, P62 to P64*4 Average output current= operating current × operating ratio (1 pin)
	$I_{OLAV2}$		12		P00 to P03, P05 to P07, P62 to P64*4 Average output current= operating current × operating ratio (1 pin)
“L” level total maximum output current	$\sum I_{OL}$	—	100	mA	
“L” level total average output current	$\sum I_{OLAV}$	—	50	mA	Total average output current= operating current × operating ratio (Total number of pins)
“H” level maximum output current	$I_{OH}$	—	-15	mA	
“H” level average current	$I_{OHAV1}$	—	-4	mA	Other than P00 to P03, P05 to P07, P62 to P64*4 Average output current= operating current × operating ratio (1 pin)
	$I_{OHAV2}$		-8		P00 to P03, P05 to P07, P62 to P64*4 Average output current= operating current × operating ratio (1 pin)
“H” level total maximum output current	$\sum I_{OH}$	—	-100	mA	
“H” level total average output current	$\sum I_{OHAV}$	—	-50	mA	Total average output current= operating current × operating ratio (Total number of pins)
Power consumption	$P_d$	—	320	mW	
Operating temperature	$T_A$	-40	+85	°C	
Storage temperature	$T_{stg}$	-55	+150	°C	

\*1: These parameters are based on the condition that  $V_{SS}$  is 0.0 V.

- \*2:  $V_i$  and  $V_o$  must not exceed  $V_{CC} + 0.3$  V.  $V_i$  must not exceed the rated voltage. However, if the maximum current to/from an input is limited by means of an external component, the  $I_{CLAMP}$  rating is used instead of the  $V_i$  rating.
- \*3: Applicable to the following pins: P00 to P07, P62 to P64, PF0, PF1, PG1, PG2 (P00, and P62 to P64 are only available on MB95F562H/F562K/F563H/F563K/F564H/F564K. P01, P02, P03, P07, PF0, PF1, PG1, and PG2 are only available on MB95F562H/F562K/F563H/F563K/F564H/F564K/F582H/F582K/F583H/F583K/F584H/F584K.)
- Use under recommended operating conditions.
  - Use with DC voltage (current).
  - The HV (High Voltage) signal is an input signal exceeding the  $V_{CC}$  voltage. Always connect a limiting resistor between the HV (High Voltage) signal and the microcontroller before applying the HV (High Voltage) signal.
  - The value of the limiting resistor should be set to a value at which the current to be input to the microcontroller pin when the HV (High Voltage) signal is input is below the standard value, irrespective of whether the current is transient current or stationary current.
  - When the microcontroller drive current is low, such as in low power consumption modes, the HV (High Voltage) input potential may pass through the protective diode to increase the potential of the  $V_{CC}$  pin, affecting other devices.
  - If the HV (High Voltage) signal is input when the microcontroller power supply is off (not fixed at 0 V), since power is supplied from the pins, incomplete operations may be executed.
  - If the HV (High Voltage) input is input after power-on, since power is supplied from the pins, the voltage of power supply may not be sufficient to enable a power-on reset.
  - Do not leave the HV (High Voltage) input pin unconnected.
  - Example of a recommended circuit:

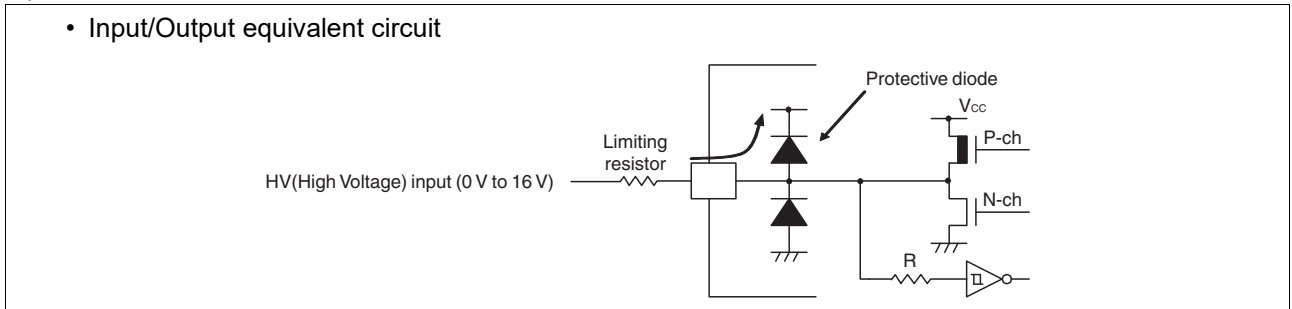

- \*4: P62 and P63 are only available on MB95F562H/F562K/F563H/F563K/F564H/F564K.

**WARNING:** Semiconductor devices may be permanently damaged by application of stress (including, without limitation, voltage, current or temperature) in excess of absolute maximum ratings. Do not exceed any of these ratings.

## 24.2 Recommended Operating Conditions

(V<sub>SS</sub> = 0.0 V)

Parameter	Symbol	Value		Unit	Remarks	
		Min	Max			
Power supply voltage	V <sub>CC</sub>	2.4 <sup>*1, *2</sup>	5.5 <sup>*1</sup>	V	In normal operation	Other than on-chip debug mode
		2.3	5.5		Hold condition in stop mode	
		2.9	5.5		In normal operation	On-chip debug mode
		2.3	5.5		Hold condition in stop mode	
Decoupling capacitor	C <sub>s</sub>	0.022	1	μF	*3	
Operating temperature	T <sub>A</sub>	-40	+85	°C	Other than on-chip debug mode	
		+5	+35		On-chip debug mode	

\*1: The value varies depending on the operating frequency, the machine clock and the analog guaranteed range.

\*2: The minimum power supply voltage becomes 2.88 V when a product with the low-voltage detection reset is used.

\*3: Use a ceramic capacitor or a capacitor with equivalent frequency characteristics. The decoupling capacitor for the V<sub>CC</sub> pin must have a capacitance equal to or larger than the capacitance of C<sub>s</sub>. For the connection to a decoupling capacitor C<sub>s</sub>, see the diagram below. To prevent the device from unintentionally entering an unknown mode due to noise, minimize the distance between the C pin and C<sub>s</sub> and the distance between C<sub>s</sub> and the V<sub>SS</sub> pin when designing the layout of a printed circuit board.

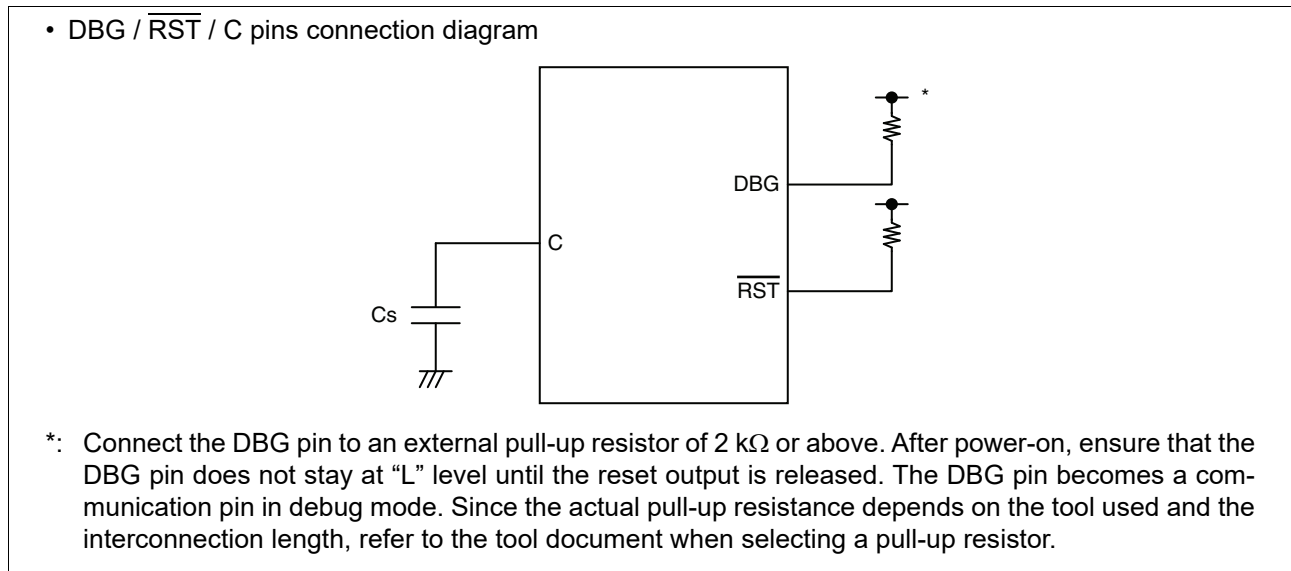

**WARNING:** The recommended operating conditions are required in order to ensure the normal operation of the semiconductor device. All of the device's electrical characteristics are warranted when the device is operated under these conditions.

Any use of semiconductor devices will be under their recommended operating condition.

Operation under any conditions other than these conditions may adversely affect reliability of device and could result in device failure.

No warranty is made with respect to any use, operating conditions or combinations not represented on this data sheet. If you are considering application under any conditions other than listed herein, please contact sales representatives beforehand.

**24.3 DC Characteristics**

 ( $V_{CC} = 5.0\text{ V} \pm 10\%$ ,  $V_{SS} = 0.0\text{ V}$ ,  $T_A = -40\text{ }^\circ\text{C}$  to  $+85\text{ }^\circ\text{C}$ )

Parameter	Symbol	Pin name	Condition	Value			Unit	Remarks
				Min	Typ	Max		
"H" level input voltage	$V_{IH}$	P04	—	$0.7 V_{CC}$	—	$V_{CC} + 0.3$	V	Hysteresis input
	$V_{IHS}$	P00* <sup>3</sup> to P03* <sup>4</sup> , P05 to P07* <sup>4</sup> , P12, P62 to P64* <sup>3</sup> , PF0* <sup>4</sup> , PF1* <sup>4</sup> , PG1* <sup>4</sup> , PG2* <sup>4</sup>	—	$0.8 V_{CC}$	—	$V_{CC} + 0.3$	V	Hysteresis input
	$V_{IHM}$	PF2	—	$0.8 V_{CC}$	—	$V_{CC} + 0.3$	V	Hysteresis input
"L" level input voltage	$V_{IL}$	P04	—	$V_{SS} - 0.3$	—	$0.3 V_{CC}$	V	Hysteresis input
	$V_{ILS}$	P00* <sup>3</sup> to P03* <sup>4</sup> , P05 to P07* <sup>4</sup> , P12, P62 to P64* <sup>3</sup> , PF0* <sup>4</sup> , PF1* <sup>4</sup> , PG1* <sup>4</sup> , PG2* <sup>4</sup>	—	$V_{SS} - 0.3$	—	$0.2 V_{CC}$	V	Hysteresis input
	$V_{ILM}$	PF2	—	$V_{SS} - 0.3$	—	$0.2 V_{CC}$	V	Hysteresis input
Open-drain output application voltage	$V_D$	P12, PF2	—	$V_{SS} - 0.3$	—	$V_{SS} + 5.5$	V	
"H" level output voltage	$V_{OH1}$	P04, PF0* <sup>4</sup> , PF1* <sup>4</sup> , PG1* <sup>4</sup> , PG2	$I_{OH} = -4\text{ mA}$	$V_{CC} - 0.5$	—	—	V	
	$V_{OH2}$	P00* <sup>3</sup> to P03* <sup>4</sup> , P05 to P07* <sup>4</sup> , P62 to P64* <sup>3</sup>	$I_{OH} = -8\text{ mA}$	$V_{CC} - 0.5$	—	—	V	
"L" level output voltage	$V_{OL1}$	P04, P12, PF0 to PF2* <sup>4</sup> , PG1* <sup>4</sup> , PG2* <sup>4</sup>	$I_{OL} = 4\text{ mA}$	—	—	0.4	V	
	$V_{OL2}$	P00* <sup>3</sup> to P03* <sup>4</sup> , P05 to P07* <sup>4</sup> , P62 to P64* <sup>3</sup>	$I_{OL} = 12\text{ mA}$	—	—	0.4	V	
Input leak current (Hi-Z output leak current)	$I_{LI}$	All input pins	$0.0\text{ V} < V_I < V_{CC}$	-5	—	+5	$\mu\text{A}$	When the internal pull-up resistor is disabled
Internal pull-up resistor	$R_{PULL}$	P00* <sup>3</sup> to P07* <sup>4</sup> , P62 to P64* <sup>3</sup> , PG1* <sup>4</sup> , PG2* <sup>4</sup>	$V_I = 0\text{ V}$	25	50	100	k $\Omega$	When the internal pull-up resistor is enabled
Input capacitance	$C_{IN}$	Other than $V_{CC}$ and $V_{SS}$	$f = 1\text{ MHz}$	—	5	15	pF	

(V<sub>CC</sub> = 5.0 V ± 10%, V<sub>SS</sub> = 0.0 V, T<sub>A</sub> = -40 °C to +85 °C)

Parameter	Symbol	Pin name	Condition	Value			Unit	Remarks	
				Min	Typ*1	Max*2			
Power supply current*5	I <sub>CC</sub>	V <sub>CC</sub> (External clock operation)	F <sub>CH</sub> = 32 MHz F <sub>MP</sub> = 16 MHz Main clock mode (divided by 2)	—	3.5	4.4	mA	Except during Flash memory programming and erasing	
				—	7.4	9.8	mA	During Flash memory programming and erasing	
				—	5.1	6.4	mA	At A/D conversion	
	I <sub>CCS</sub>		F <sub>CH</sub> = 32 MHz F <sub>MP</sub> = 16 MHz Main sleep mode (divided by 2)	—	1.2	1.5	mA		
	I <sub>CCL</sub>		F <sub>CL</sub> = 32 kHz F <sub>MPL</sub> = 16 kHz Subclock mode (divided by 2) T <sub>A</sub> = +25 °C	—	65	71	μA		
	I <sub>CCLS</sub> *6		F <sub>CL</sub> = 32 kHz F <sub>MPL</sub> = 16 kHz Subsleep mode (divided by 2) T <sub>A</sub> = +25 °C	—	5.4	7	μA	In deep standby mode	
	I <sub>CC1</sub> *6		F <sub>CL</sub> = 32 kHz Watch mode T <sub>A</sub> = +25 °C	—	4.8	6.9	μA	In deep standby mode	
	I <sub>CCMCR</sub>		V <sub>CC</sub>	F <sub>CRH</sub> = 4 MHz F <sub>MP</sub> = 4 MHz Main CR clock mode	—	1.1	1.4	mA	
	I <sub>CCSCR</sub>			Sub-CR clock mode (divided by 2) T <sub>A</sub> = +25 °C	—	58	64	μA	
	I <sub>CC1S</sub>		V <sub>CC</sub> (External clock operation)	F <sub>CH</sub> = 32 MHz Time-base timer mode T <sub>A</sub> = +25 °C	—	290	340	μA	In deep standby mode
I <sub>CC1H</sub>	Main stop mode (single external clock product)/ Substop mode (dual external clock product) T <sub>A</sub> = +25 °C	—		4.1	6.5	μA	In deep standby mode		



(V<sub>CC</sub> = 5.0 V ± 10%, V<sub>SS</sub> = 0.0 V, T<sub>A</sub> = -40 °C to +85 °C)

Parameter	Symbol	Pin name	Condition	Value			Unit	Remarks
				Min	Typ* <sup>1</sup>	Max* <sup>2</sup>		
Power supply current* <sup>5</sup>	I <sub>LVD</sub>	V <sub>CC</sub>	Current consumption for the low-voltage detection circuit	—	3.6	6.6	μA	
	I <sub>CRH</sub>		Current consumption for the main CR oscillator	—	220	280	μA	
	I <sub>CRL</sub>		Current consumption for the sub-CR oscillator oscillating at 100 kHz	—	5.1	9.3	μA	
	I <sub>INSTBY</sub>		Current consumption difference between normal standby mode and deep standby mode T <sub>A</sub> = +25 °C	—	20	30	μA	

\*1: V<sub>CC</sub> = 5.0 V, T<sub>A</sub> = + 25 °C

\*2: V<sub>CC</sub> = 5.5 V, T<sub>A</sub> = + 85 °C (unless otherwise specified)

\*3: P00, P62, P63 and P64 are only available on MB95F562H/F562K/F563H/F563K/F564H/F564K.

\*4: P01, P02, P03, P07, PF0, PF1, PG1 and PG2 are only available on MB95F562H/F562K/F563H/F563K/F564H/F564K/F582H/F582K/F583H/F583K/F584H/F584K.

\*5: • The power supply current is determined by the external clock. When the low-voltage detection option is selected, the power-supply current will be the sum of adding the current consumption of the low-voltage detection circuit (I<sub>LVD</sub>) to one of the value from I<sub>CC</sub> to I<sub>CH</sub>. In addition, when both the low-voltage detection option and the CR oscillator are selected, the power supply current will be the sum of adding up the current consumption of the low-voltage detection circuit, the current consumption of the CR oscillators (I<sub>CRH</sub>, I<sub>CRL</sub>) and a specified value. In on-chip debug mode, the CR oscillator (I<sub>CRH</sub>) and the low-voltage detection circuit are always enabled, and current consumption therefore increases accordingly.

- See “24.4 AC Characteristics: Clock Timing” for F<sub>CH</sub> and F<sub>CL</sub>.
- See “24.4 AC Characteristics: Source Clock / Machine Clock” for F<sub>MP</sub> and F<sub>MPL</sub>.

\*6: In sub-CR clock mode, the power supply current value is the sum of adding I<sub>CRL</sub> to I<sub>CCLS</sub> or I<sub>CC</sub>T. In addition, when the sub-CR clock mode is selected with F<sub>MPL</sub> being 50 kHz, the current consumption increases accordingly.

## 24.4 AC Characteristics

### 24.4.1 Clock Timing

( $V_{CC} = 2.4\text{ V to }5.5\text{ V}$ ,  $V_{SS} = 0.0\text{ V}$ ,  $T_A = -40\text{ }^\circ\text{C to }+85\text{ }^\circ\text{C}$ )

Parameter	Symbol	Pin name	Condition	Value			Unit	Remarks	
				Min	Typ	Max			
Clock frequency	F <sub>CH</sub>	X0, X1	—	1	—	16.25	MHz	When the main oscillation circuit is used	
		X0	X1: open	1	—	12	MHz	When the main external clock is used	
		X0, X1	*	1	—	32.5	MHz	When the main external clock is used	
	F <sub>CRH</sub>	—	—	—	3.92	4	4.08	MHz	Operating conditions • The main CR clock is used. • $0\text{ }^\circ\text{C} \leq T_A \leq +70\text{ }^\circ\text{C}$
					3.8	4	4.2	MHz	Operating conditions • The main CR clock is used. • $-40\text{ }^\circ\text{C} \leq T_A < 0\text{ }^\circ\text{C}$ , $+70\text{ }^\circ\text{C} < T_A \leq +85\text{ }^\circ\text{C}$
	F <sub>MCRPLL</sub>	—	—	—	7.84	8	8.16	MHz	Operating conditions • PLL multiplication rate: 2 • $0\text{ }^\circ\text{C} \leq T_A \leq +70\text{ }^\circ\text{C}$
					7.6	8	8.4	MHz	Operating conditions • PLL multiplication rate: 2 • $-40\text{ }^\circ\text{C} \leq T_A < 0\text{ }^\circ\text{C}$ , $+70\text{ }^\circ\text{C} < T_A \leq +85\text{ }^\circ\text{C}$
					9.8	10	10.2	MHz	Operating conditions • PLL multiplication rate: 2.5 • $0\text{ }^\circ\text{C} \leq T_A \leq +70\text{ }^\circ\text{C}$
					9.5	10	10.5	MHz	Operating conditions • PLL multiplication rate: 2.5 • $-40\text{ }^\circ\text{C} \leq T_A < 0\text{ }^\circ\text{C}$ , $+70\text{ }^\circ\text{C} < T_A \leq +85\text{ }^\circ\text{C}$
					11.76	12	12.24	MHz	Operating conditions • PLL multiplication rate: 3 • $0\text{ }^\circ\text{C} \leq T_A \leq +70\text{ }^\circ\text{C}$
					11.4	12	12.6	MHz	Operating conditions • PLL multiplication rate: 3 • $-40\text{ }^\circ\text{C} \leq T_A < 0\text{ }^\circ\text{C}$ , $+70\text{ }^\circ\text{C} < T_A \leq +85\text{ }^\circ\text{C}$
					15.68	16	16.32	MHz	Operating conditions • PLL multiplication rate: 4 • $0\text{ }^\circ\text{C} \leq T_A \leq +70\text{ }^\circ\text{C}$
					15.2	16	16.8	MHz	Operating conditions • PLL multiplication rate: 4 • $-40\text{ }^\circ\text{C} \leq T_A < 0\text{ }^\circ\text{C}$ , $+70\text{ }^\circ\text{C} < T_A \leq +85\text{ }^\circ\text{C}$
	F <sub>CL</sub>	X0A, X1A	—	—	—	32.768	—	kHz	When the suboscillation circuit is used
					—	32.768	—	kHz	When the sub-external clock is used
	F <sub>CRL</sub>	—	—	—	50	100	150	kHz	When the sub-CR clock is used

( $V_{CC} = 2.4\text{ V to }5.5\text{ V}$ ,  $V_{SS} = 0.0\text{ V}$ ,  $T_A = -40\text{ }^\circ\text{C to }+85\text{ }^\circ\text{C}$ )

Parameter	Symbol	Pin name	Condition	Value			Unit	Remarks
				Min	Typ	Max		
Clock cycle time	$t_{HCYL}$	X0, X1	—	61.5	—	1000	ns	When the main oscillation circuit is used
		X0	X1: open	83.4	—	1000	ns	When an external clock is used
		X0, X1	*	30.8	—	1000	ns	
	$t_{LCYL}$	X0A, X1A	—	—	30.5	—	$\mu\text{s}$	When the subclock is used
Input clock pulse width	$t_{WH1}$ , $t_{WL1}$	X0	X1: open	33.4	—	—	ns	When an external clock is used, the duty ratio should range between 40% and 60%.
		X0, X1	*	12.4	—	—	ns	
	$t_{WH2}$ , $t_{WL2}$	X0A	—	—	15.2	—	$\mu\text{s}$	
Input clock rising time and falling time	$t_{CR}$ , $t_{CF}$	X0, X0A	X1: open	—	—	5	ns	When an external clock is used
		X0, X1, X0A, X1A	*	—	—	5	ns	
CR oscillation start time	$t_{CRHWK}$	—	—	—	—	50	$\mu\text{s}$	When the main CR clock is used
	$t_{CRLWK}$	—	—	—	—	30	$\mu\text{s}$	When the sub-CR clock is used

\*: The external clock signal is input to X0 and the inverted external clock signal to X1.

• Input waveform generated when an external clock (main clock) is used

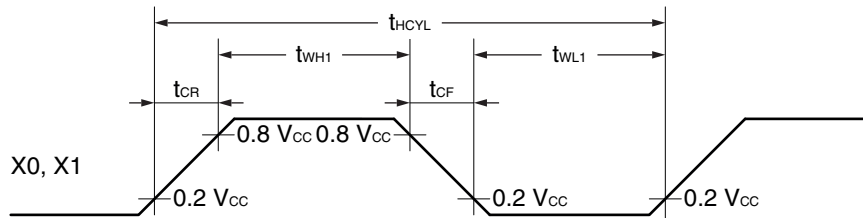

• Figure of main clock input port external connection

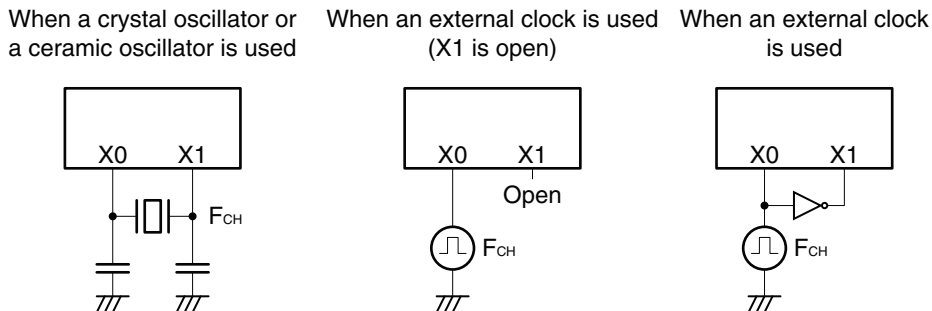

- Input waveform generated when an external clock (subclock) is used

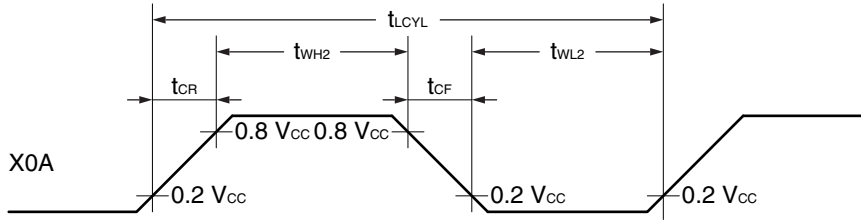

- Figure of subclock input port external connection

When a crystal oscillator or a ceramic oscillator is used

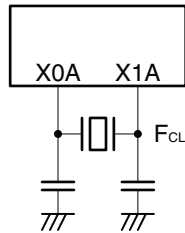

When an external clock is used

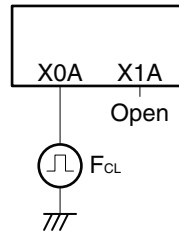

24.4.2 Source Clock / Machine Clock

(V<sub>CC</sub> = 5.0 V ± 10%, V<sub>SS</sub> = 0.0 V, T<sub>A</sub> = -40 °C to +85 °C)

Parameter	Symbol	Pin name	Value			Unit	Remarks
			Min	Typ	Max		
Source clock cycle time*1	t <sub>SCLK</sub>	—	61.5	—	2000	ns	When the main external clock is used Min: F <sub>CH</sub> = 32.5 MHz, divided by 2 Max: F <sub>CH</sub> = 1 MHz, divided by 2
			62.5	—	1000	ns	When the main CR clock is used Min: F <sub>CRH</sub> = 4 MHz, multiplied by 4 Max: F <sub>CRH</sub> = 4 MHz, divided by 4
			—	61	—	μs	When the suboscillation clock is used F <sub>CL</sub> = 32.768 kHz, divided by 2
			—	20	—	μs	When the sub-CR clock is used F <sub>CRL</sub> = 100 kHz, divided by 2
Source clock frequency	F <sub>SP</sub>	—	0.5	—	16.25	MHz	When the main oscillation clock is used
			—	4	—	MHz	When the main CR clock is used
	—		16.384	—	kHz	When the suboscillation clock is used	
	F <sub>SPL</sub>		—	50	—	kHz	When the sub-CR clock is used F <sub>CRL</sub> = 100 kHz, divided by 2
—		—	—	—	—	—	
Machine clock cycle time*2 (minimum instruction execution time)	t <sub>MCLK</sub>	—	61.5	—	32000	ns	When the main oscillation clock is used Min: F <sub>SP</sub> = 16.25 MHz, no division Max: F <sub>SP</sub> = 0.5 MHz, divided by 16
			250	—	1000	ns	When the main CR clock is used Min: F <sub>SP</sub> = 4 MHz, no division Max: F <sub>SP</sub> = 4 MHz, divided by 4
			61	—	976.5	μs	When the suboscillation clock is used Min: F <sub>SPL</sub> = 16.384 kHz, no division Max: F <sub>SPL</sub> = 16.384 kHz, divided by 16
			20	—	320	μs	When the sub-CR clock is used Min: F <sub>SPL</sub> = 50 kHz, no division Max: F <sub>SPL</sub> = 50 kHz, divided by 16
Machine clock frequency	F <sub>MP</sub>	—	0.031	—	16.25	MHz	When the main oscillation clock is used
			0.25	—	16	MHz	When the main CR clock is used
	F <sub>MPL</sub>		1.024	—	16.384	kHz	When the suboscillation clock is used
			3.125	—	50	kHz	When the sub-CR clock is used F <sub>CRL</sub> = 100 kHz

\*1: This is the clock before it is divided according to the division ratio set by the machine clock division ratio select bits (SYCC:DIV[1:0]). This source clock is divided to become a machine clock according to the division ratio set by the machine clock division ratio select bits (SYCC:DIV[1:0]). In addition, a source clock can be selected from the following.

- Main clock divided by 2
- Main CR clock
- PLL multiplication of main CR clock (Select a multiplication rate from 2, 2.5, 3 and 4.)
- Subclock divided by 2
- Sub-CR clock divided by 2

\*2: This is the operating clock of the microcontroller. A machine clock can be selected from the following.

- Source clock (no division)
- Source clock divided by 4
- Source clock divided by 8
- Source clock divided by 16



• Schematic diagram of the clock generation block





- Operating voltage - Operating frequency ( $T_A = -40^{\circ}\text{C}$  to  $+85^{\circ}\text{C}$ )  
 Without the on-chip debug function

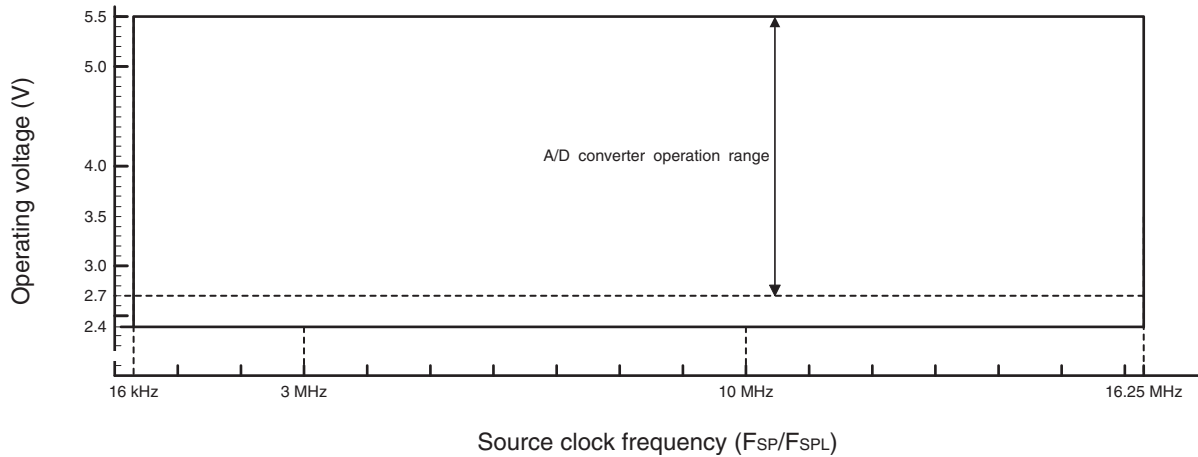

- Operating voltage - Operating frequency ( $T_A = -40^{\circ}\text{C}$  to  $+85^{\circ}\text{C}$ )  
 With the on-chip debug function

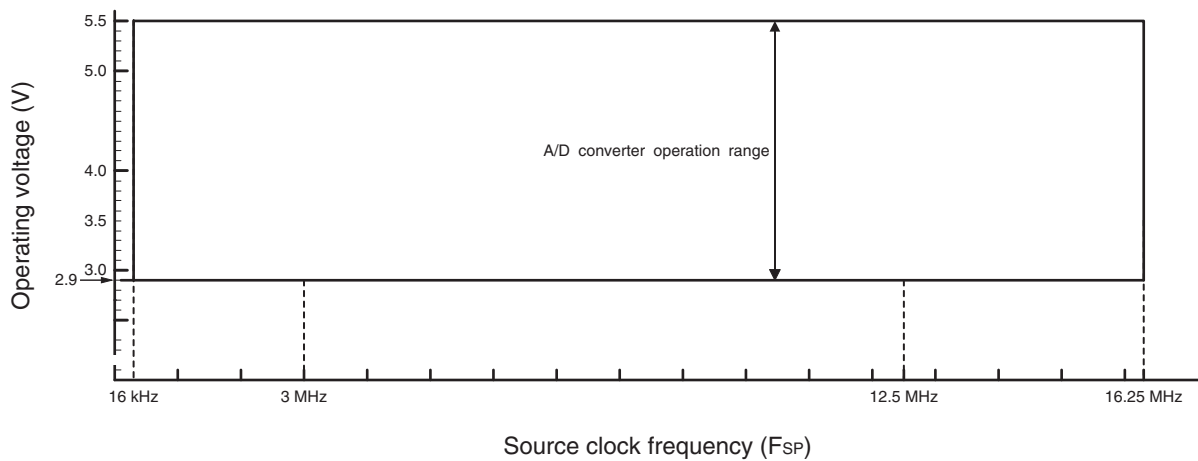



24.4.3 External Reset

( $V_{CC} = 5.0\text{ V} \pm 10\%$ ,  $V_{SS} = 0.0\text{ V}$ ,  $T_A = -40\text{ }^\circ\text{C}$  to  $+85\text{ }^\circ\text{C}$ )

Parameter	Symbol	Value		Unit	Remarks
		Min	Max		
RST "L" level pulse width	$t_{RSTL}$	$2 t_{MCLK}^{*1}$	—	ns	In normal operation

\*1: See "Source Clock / Machine Clock" for  $t_{MCLK}$ .

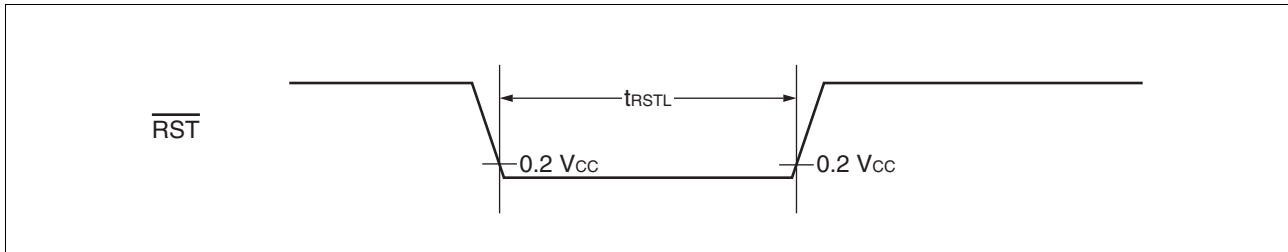



#### 24.4.4 Power-on Reset

( $V_{SS} = 0.0\text{ V}$ ,  $T_A = -40\text{ }^\circ\text{C}$  to  $+85\text{ }^\circ\text{C}$ )

Parameter	Symbol	Condition	Value		Unit	Remarks
			Min	Max		
Power supply rising time	$t_R$	—	—	50	ms	
Power supply cutoff time	$t_{OFF}$	—	1	—	ms	Wait time until power-on

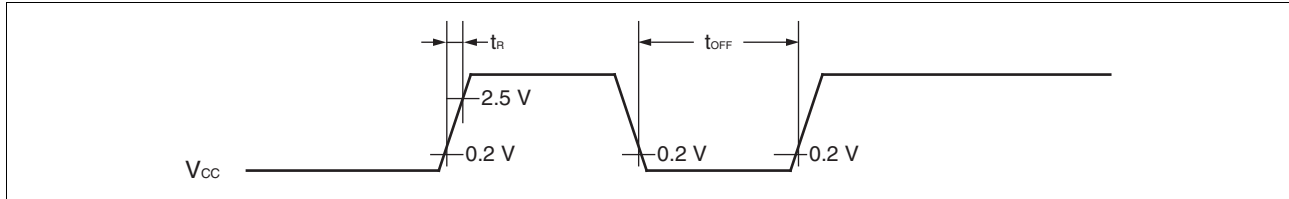

Note: A sudden change of power supply voltage may activate the power-on reset function. When changing the power supply voltage during the operation, set the slope of rising to a value below within  $30\text{ mV/ms}$  as shown below.

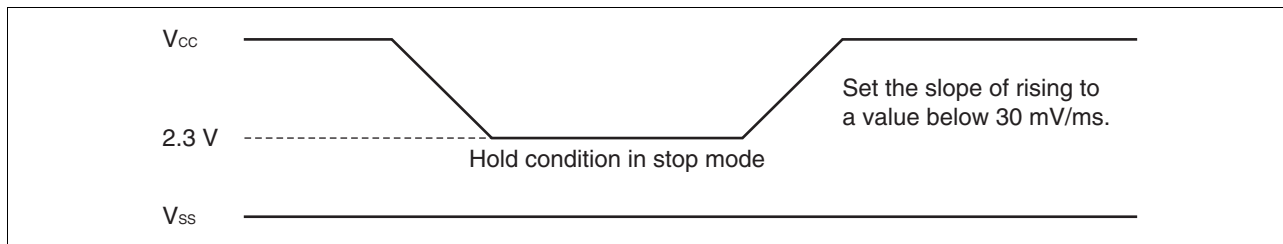

#### 24.4.5 Peripheral Input Timing

( $V_{CC} = 5.0\text{ V} \pm 10\%$ ,  $V_{SS} = 0.0\text{ V}$ ,  $T_A = -40\text{ }^\circ\text{C}$  to  $+85\text{ }^\circ\text{C}$ )

Parameter	Symbol	Pin name	Value		Unit
			Min	Max	
Peripheral input "H" pulse width	$t_{LH}$	INT02 to INT07*1,*2, EC0*1, EC1*3	$2 t_{MCLK}^{*4}$	—	ns
Peripheral input "L" pulse width	$t_{HL}$		$2 t_{MCLK}^{*4}$	—	ns

\*1: INT04, INT06 and EC0 are available on all products.

\*2: INT02, INT03, INT05 and INT07 are only available on MB95F562H/F562K/F563H/F563K/F564H/F564K/F582H/F582K/F583H/F583K/F584H/F584K.

\*3: EC1 is only available on MB95F562H/F562K/F563H/F563K/F564H/F564K.

\*4: See "Source Clock / Machine Clock" for  $t_{MCLK}$ .

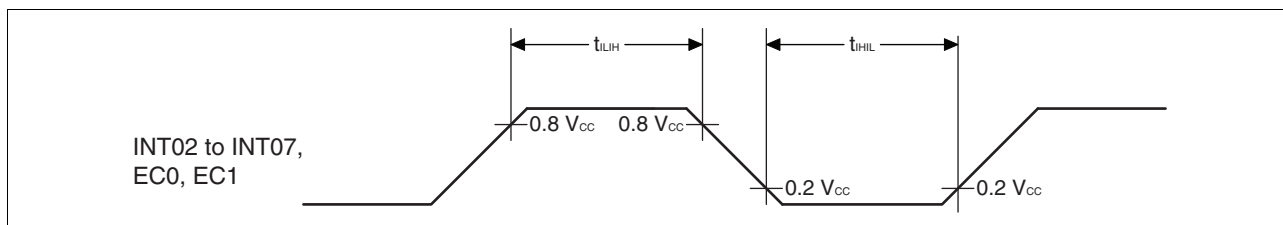

24.4.6 LIN-UART Timing (only available on MB95F562H/F562K/F563H/F563K/F564H/F564K/F582H/F582K/F583H/F583K/F584H/F584K)

Sampling is executed at the rising edge of the sampling clock\*<sup>1</sup>, and serial clock delay is disabled\*<sup>2</sup>.  
 (ESCR register: SCES bit = 0, ECCR register: SCDE bit = 0)

(V<sub>CC</sub> = 5.0 V ± 10%, AV<sub>SS</sub> = V<sub>SS</sub> = 0.0 V, T<sub>A</sub> = -40 °C to +85 °C)

Parameter	Symbol	Pin name	Condition	Value		Unit
				Min	Max	
Serial clock cycle time	t <sub>SCYC</sub>	SCK	Internal clock operation output pin: C <sub>L</sub> = 80 pF + 1 TTL	5 t <sub>MCLK</sub> * <sup>3</sup>	—	ns
SCK ↓→ SOT delay time	t <sub>SLOVI</sub>	SCK, SOT		-50	+50	ns
Valid SIN → SCK ↑	t <sub>IVSHI</sub>	SCK, SIN		t <sub>MCLK</sub> * <sup>3</sup> + 80	—	ns
SCK ↑→ valid SIN hold time	t <sub>SHIXI</sub>	SCK, SIN		0	—	ns
Serial clock "L" pulse width	t <sub>SLSH</sub>	SCK	External clock operation output pin: C <sub>L</sub> = 80 pF + 1 TTL	3 t <sub>MCLK</sub> * <sup>3</sup> - t <sub>R</sub>	—	ns
Serial clock "H" pulse width	t <sub>SHSL</sub>	SCK		t <sub>MCLK</sub> * <sup>3</sup> + 10	—	ns
SCK ↓→ SOT delay time	t <sub>SLOVE</sub>	SCK, SOT		—	2 t <sub>MCLK</sub> * <sup>3</sup> + 60	ns
Valid SIN → SCK ↑	t <sub>IVSHE</sub>	SCK, SIN		30	—	ns
SCK ↑→ valid SIN hold time	t <sub>SHIXE</sub>	SCK, SIN		t <sub>MCLK</sub> * <sup>3</sup> + 30	—	ns
SCK fall time	t <sub>F</sub>	SCK		—	10	ns
SCK rise time	t <sub>R</sub>	SCK		—	10	ns

\*1: There is a function used to choose whether the sampling of reception data is performed at a rising edge or a falling edge of the serial clock.

\*2: The serial clock delay function is a function used to delay the output signal of the serial clock for half the clock.

\*3: See "Source Clock / Machine Clock" for t<sub>MCLK</sub>.

• Internal shift clock mode

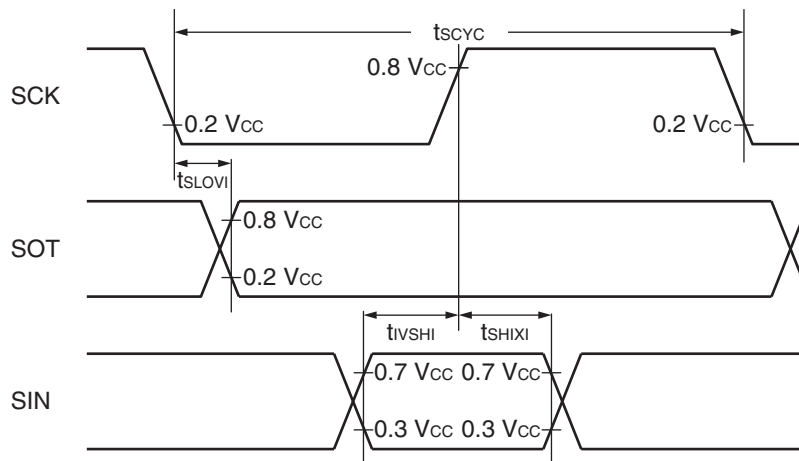



• External shift clock mode

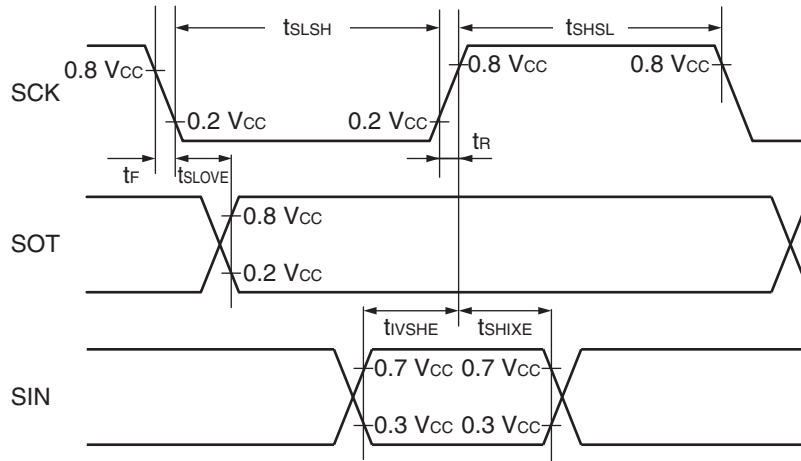

Sampling is executed at the falling edge of the sampling clock\*<sup>1</sup>, and serial clock delay is disabled\*<sup>2</sup>.  
 (ESCR register: SCES bit = 1, ECCR register: SCDE bit = 0)

( $V_{CC} = 5.0\text{ V} \pm 10\%$ ,  $V_{SS} = 0.0\text{ V}$ ,  $T_A = -40\text{ }^\circ\text{C}$  to  $+85\text{ }^\circ\text{C}$ )

Parameter	Symbol	Pin name	Condition	Value		Unit
				Min	Max	
Serial clock cycle time	$t_{SCYC}$	SCK	Internal clock operation output pin: $C_L = 80\text{ pF} + 1\text{ TTL}$	$5 t_{MCLK}^{*3}$	—	ns
SCK $\uparrow \rightarrow$ SOT delay time	$t_{SHOVI}$	SCK, SOT		-50	+50	ns
Valid SIN $\rightarrow$ SCK $\downarrow$	$t_{IVSLI}$	SCK, SIN		$t_{MCLK}^{*3} + 80$	—	ns
SCK $\downarrow \rightarrow$ valid SIN hold time	$t_{SLIXI}$	SCK, SIN		0	—	ns
Serial clock "H" pulse width	$t_{SHSL}$	SCK	External clock operation output pin: $C_L = 80\text{ pF} + 1\text{ TTL}$	$3 t_{MCLK}^{*3} - t_R$	—	ns
Serial clock "L" pulse width	$t_{SLSH}$	SCK		$t_{MCLK}^{*3} + 10$	—	ns
SCK $\uparrow \rightarrow$ SOT delay time	$t_{SHOVE}$	SCK, SOT		—	$2 t_{MCLK}^{*3} + 60$	ns
Valid SIN $\rightarrow$ SCK $\downarrow$	$t_{IVSLE}$	SCK, SIN		30	—	ns
SCK $\downarrow \rightarrow$ valid SIN hold time	$t_{SLIXE}$	SCK, SIN		$t_{MCLK}^{*3} + 30$	—	ns
SCK fall time	$t_F$	SCK		—	10	ns
SCK rise time	$t_R$	SCK		—	10	ns

\*1: There is a function used to choose whether the sampling of reception data is performed at a rising edge or a falling edge of the serial clock.

\*2: The serial clock delay function is a function used to delay the output signal of the serial clock for half the clock.

\*3: See "Source Clock / Machine Clock" for  $t_{MCLK}$ .



• Internal shift clock mode

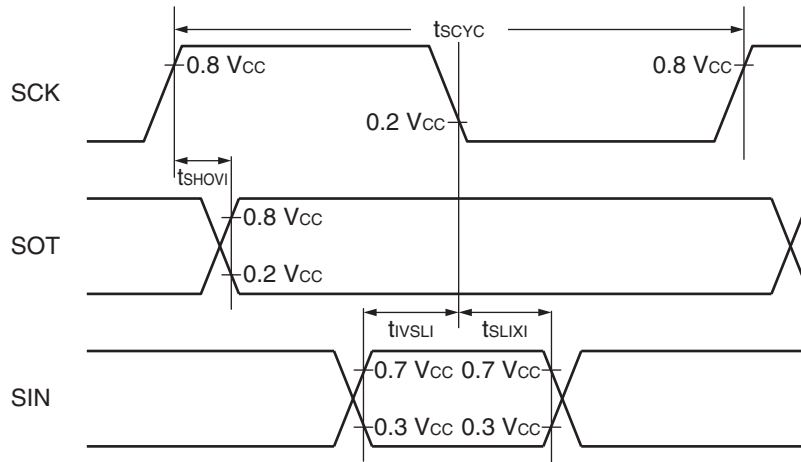

• External shift clock mode

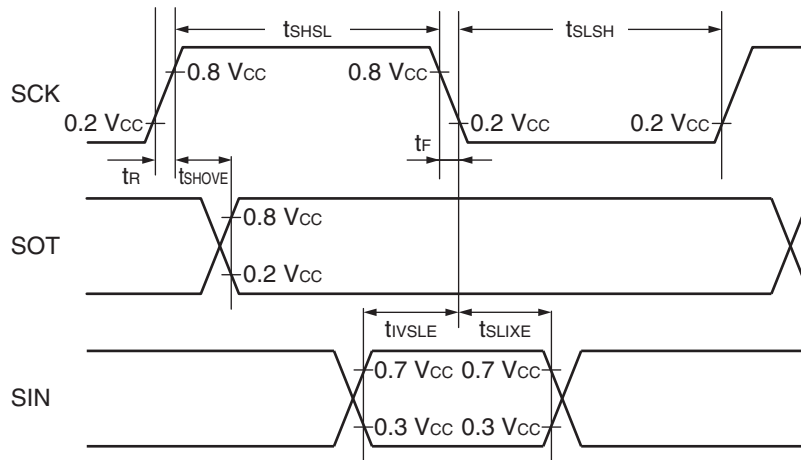

Sampling is executed at the rising edge of the sampling clock\*<sup>1</sup>, and serial clock delay is enabled\*<sup>2</sup>.  
 (ESCR register: SCES bit = 0, ECCR register: SCDE bit = 1)

(V<sub>CC</sub> = 5.0 V ± 10%, V<sub>SS</sub> = 0.0 V, T<sub>A</sub> = -40 °C to +85 °C)

Parameter	Symbol	Pin name	Condition	Value		Unit
				Min	Max	
Serial clock cycle time	t <sub>SCYC</sub>	SCK	Internal clock operation output pin: C <sub>L</sub> = 80 pF + 1 TTL	5 t <sub>MCLK</sub> * <sup>3</sup>	—	ns
SCK ↑ → SOT delay time	t <sub>SHOVI</sub>	SCK, SOT		-50	+50	ns
Valid SIN → SCK ↓	t <sub>IVSLI</sub>	SCK, SIN		t <sub>MCLK</sub> * <sup>3</sup> + 80	—	ns
SCK ↓ → valid SIN hold time	t <sub>SLIXI</sub>	SCK, SIN		0	—	ns
SOT → SCK ↓ delay time	t <sub>SOVLI</sub>	SCK, SOT		3 t <sub>MCLK</sub> * <sup>3</sup> - 70	—	ns

\*1: There is a function used to choose whether the sampling of reception data is performed at a rising edge or a falling edge of the serial clock.

\*2: The serial clock delay function is a function that delays the output signal of the serial clock for half clock.

\*3: See “Source Clock / Machine Clock” for t<sub>MCLK</sub>.

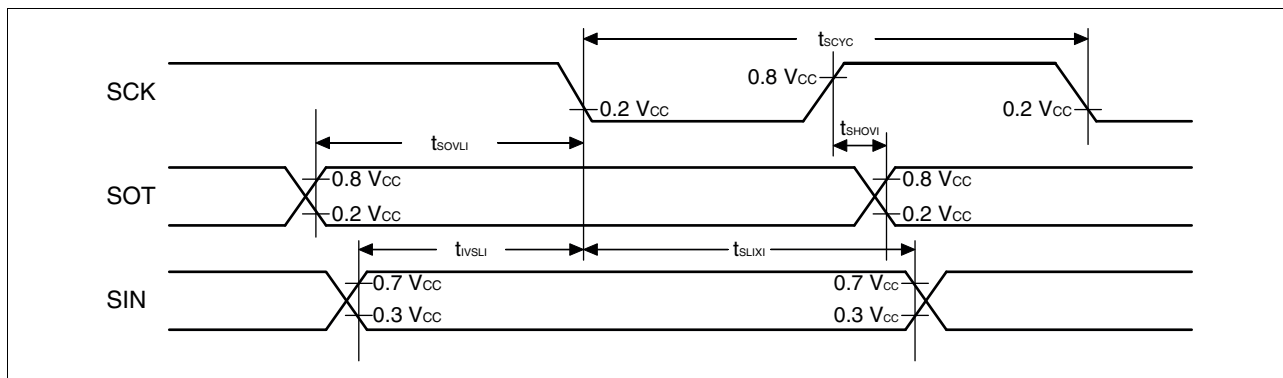

Sampling is executed at the falling edge of the sampling clock\*<sup>1</sup>, and serial clock delay is enabled\*<sup>2</sup>.  
 (ESCR register: SCES bit = 1, ECCR register: SCDE bit = 1)

(V<sub>CC</sub> = 5.0 V ± 10%, V<sub>SS</sub> = 0.0 V, T<sub>A</sub> = -40 °C to +85 °C)

Parameter	Symbol	Pin name	Condition	Value		Unit
				Min	Max	
Serial clock cycle time	t <sub>SCYC</sub>	SCK	Internal clock operating output pin: C <sub>L</sub> = 80 pF + 1 TTL	5 t <sub>MCLK</sub> * <sup>3</sup>	—	ns
SCK ↓ → SOT delay time	t <sub>SLOVI</sub>	SCK, SOT		-50	+50	ns
Valid SIN → SCK ↑	t <sub>IVSHI</sub>	SCK, SIN		t <sub>MCLK</sub> * <sup>3</sup> + 80	—	ns
SCK ↑ → valid SIN hold time	t <sub>SHIXI</sub>	SCK, SIN		0	—	ns
SOT → SCK ↑ delay time	t <sub>SOVHI</sub>	SCK, SOT		3 t <sub>MCLK</sub> * <sup>3</sup> - 70	—	ns

\*1: There is a function used to choose whether the sampling of reception data is performed at a rising edge or a falling edge of the serial clock.

\*2: The serial clock delay function is a function that delays the output signal of the serial clock for half clock.

\*3: See “Source Clock / Machine Clock” for t<sub>MCLK</sub>.

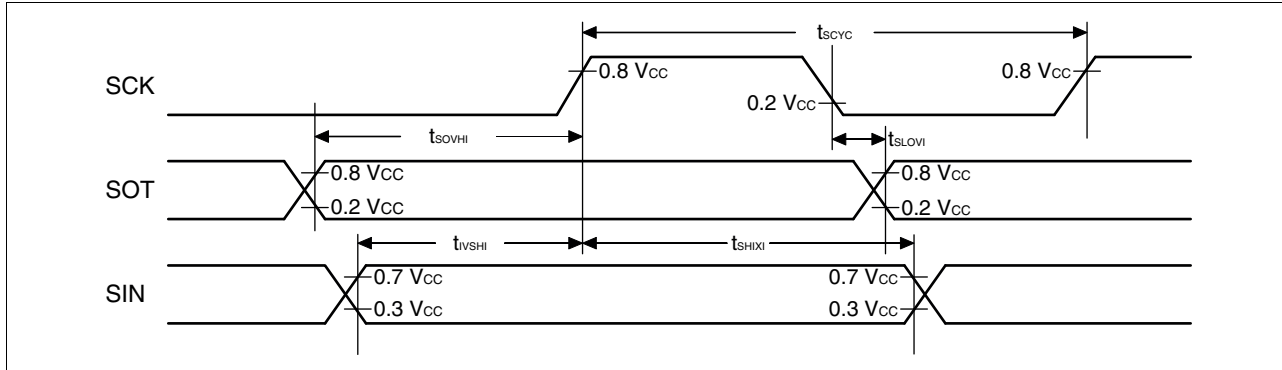

#### 24.4.7 Low-voltage Detection

(V<sub>SS</sub> = 0.0 V, T<sub>A</sub> = -40 °C to +85 °C)

Parameter	Symbol	Value			Unit	Remarks
		Min	Typ	Max		
Release voltage*	V <sub>DL+</sub>	2.52	2.7	2.88	V	At power supply rise
		2.61	2.8	2.99		
		2.89	3.1	3.31		
		3.08	3.3	3.52		
Detection voltage*	V <sub>DL-</sub>	2.43	2.6	2.77	V	At power supply fall
		2.52	2.7	2.88		
		2.80	3	3.20		
		2.99	3.2	3.41		
Hysteresis width	V <sub>HYS</sub>	—	100	—	mV	
Power supply start voltage	V <sub>off</sub>	—	—	2.3	V	
Power supply end voltage	V <sub>on</sub>	4.9	—	—	V	
Power supply voltage change time (at power supply rise)	t <sub>r</sub>	650	—	—	μs	Slope of power supply that the reset release signal generates within the rating (V <sub>DL+</sub> )
Power supply voltage change time (at power supply fall)	t <sub>r</sub>	650	—	—	μs	Slope of power supply that the reset detection signal generates within the rating (V <sub>DL-</sub> )
Reset release delay time	t <sub>d1</sub>	—	—	30	μs	
Reset detection delay time	t <sub>d2</sub>	—	—	30	μs	
LVD threshold voltage transition stabilization time	t <sub>stb</sub>	10	—	—	μs	

\*: The release voltage and the detection voltage can be selected by using the LVD reset voltage selection ID register (LVDR) in the low-voltage detection reset circuit. For details of the LVDR register, refer to “CHAPTER 18 LOW-VOLTAGE DETECTION RESET CIRCUIT” in “New 8FX MB95560H/570H/580H Hardware Manual”.

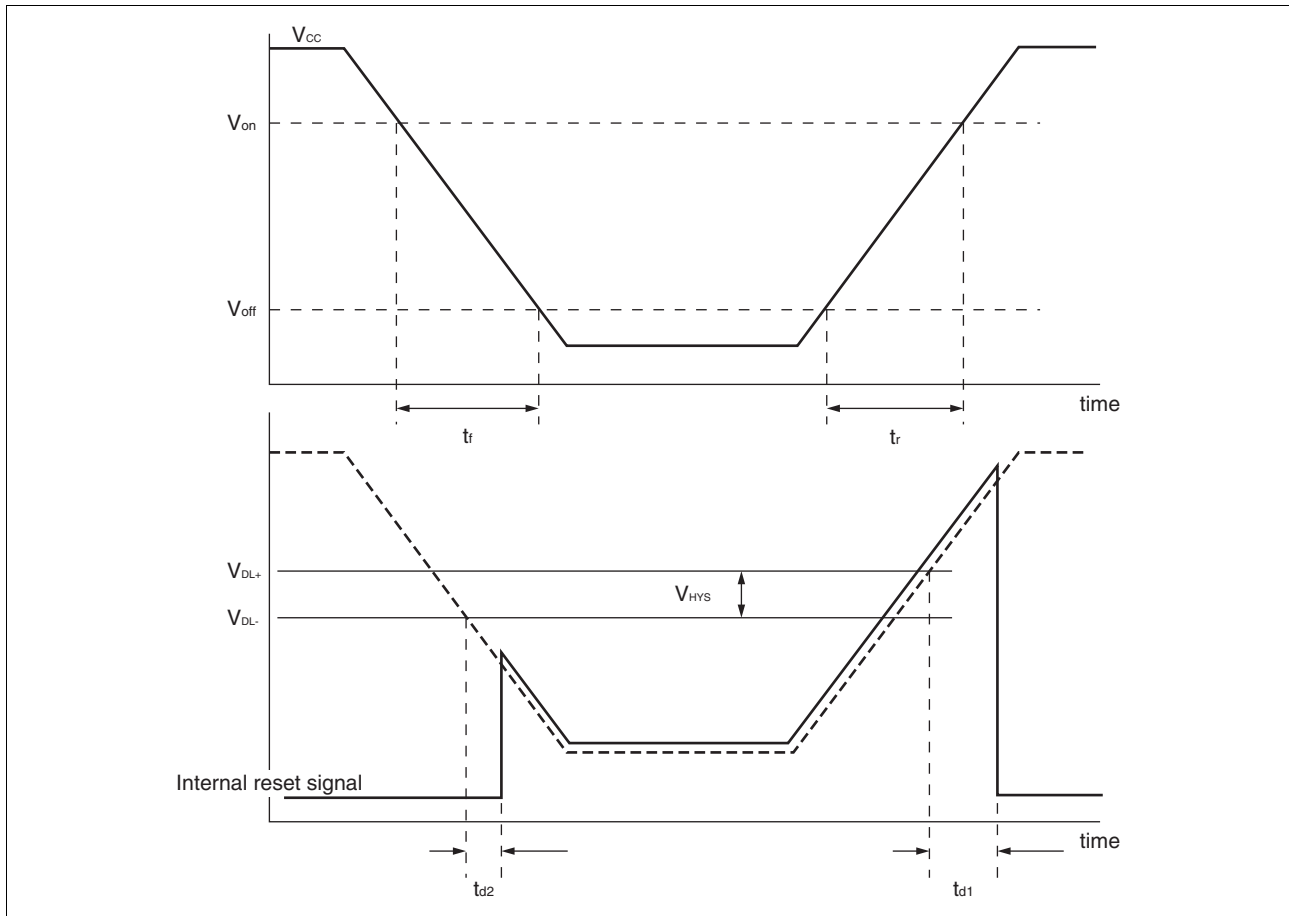



**24.5 A/D Converter**

24.5.1 A/D Converter Electrical Characteristics

( $V_{CC} = 2.7\text{ V to }5.5\text{ V}$ ,  $V_{SS} = 0.0\text{ V}$ ,  $T_A = -40\text{ }^\circ\text{C to }+85\text{ }^\circ\text{C}$ )

Parameter	Symbol	Value			Unit	Remarks
		Min	Typ	Max		
Resolution	—	—	—	10	bit	
Total error		-3	—	+3	LSB	
Linearity error		-2.5	—	+2.5	LSB	
Differential linearity error		-1.9	—	+1.9	LSB	
Zero transition voltage	$V_{0T}$	$V_{SS} - 1.5\text{ LSB}$	$V_{SS} + 0.5\text{ LSB}$	$V_{SS} + 2.5\text{ LSB}$	V	
Full-scale transition voltage	$V_{FST}$	$V_{CC} - 4.5\text{ LSB}$	$V_{CC} - 2\text{ LSB}$	$V_{CC} + 0.5\text{ LSB}$	V	
Compare time	—	1	—	10	$\mu\text{s}$	$4.5\text{ V} \leq V_{CC} \leq 5.5\text{ V}$
		3	—	10	$\mu\text{s}$	$2.7\text{ V} \leq V_{CC} < 4.5\text{ V}$
Sampling time	—	0.6	—	$\infty$	$\mu\text{s}$	$2.7\text{ V} \leq V_{CC} \leq 5.5\text{ V}$ , with external impedance $< 3.3\text{ k}\Omega$
Analog input current	$I_{AIN}$	-0.3	—	+0.3	$\mu\text{A}$	
Analog input voltage	$V_{AIN}$	$V_{SS}$	—	$V_{CC}$	V	



### 24.5.2 Notes on Using A/D Converter

- External impedance of analog input and its sampling time

The A/D converter of the MB95560H/570H/580H has a sample and hold circuit. If the external impedance is too high to keep sufficient sampling time, the analog voltage charged to the capacitor of the internal sample and hold circuit is insufficient, adversely affecting A/D conversion precision. Therefore, to satisfy the A/D conversion precision standard, considering the relationship between the external impedance and minimum sampling time, either adjust the register value and operating frequency or decrease the external impedance so that the sampling time is longer than the minimum value. In addition, if sufficient sampling time cannot be secured, connect a capacitor of about 0.1  $\mu\text{F}$  to the analog input pin.

- Analog input equivalent circuit

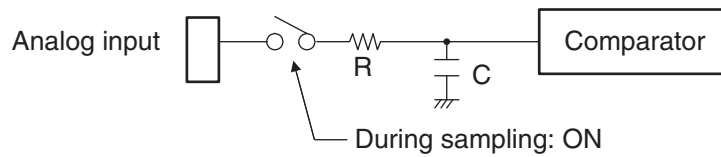

V <sub>CC</sub>	R	C
4.5 V ≤ V <sub>CC</sub> ≤ 5.5 V	1.45 kΩ (Max)	14.89 pF (Max)
2.7 V ≤ V <sub>CC</sub> < 4.5 V	2.7 kΩ (Max)	14.89 pF (Max)

Note: The values are reference values.

- Relationship between external impedance and minimum sampling time

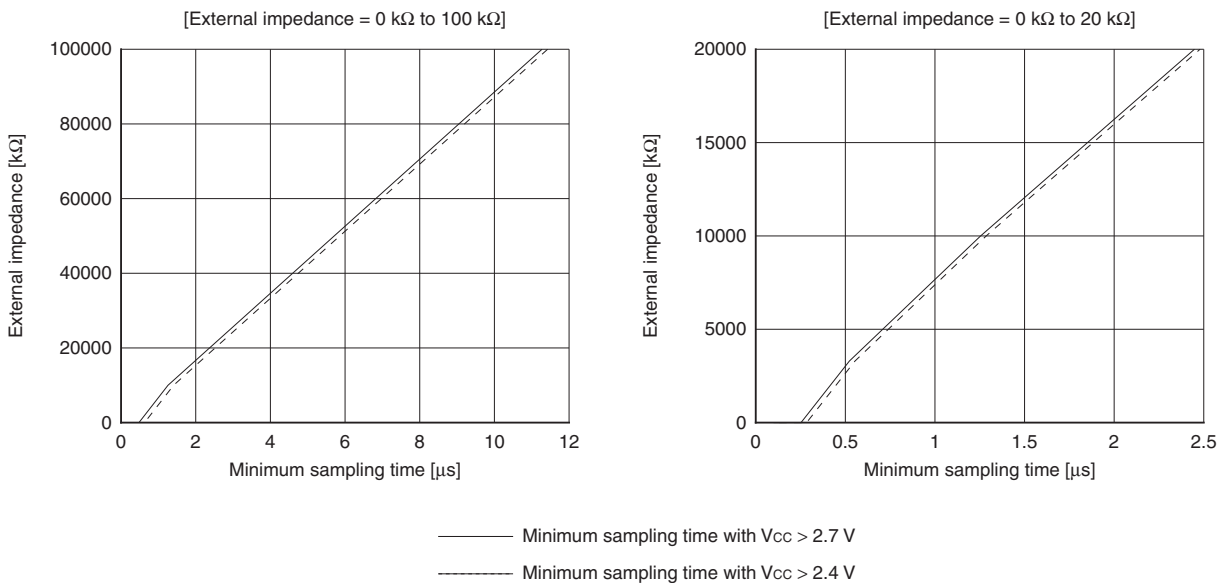

- A/D conversion error

As  $|V_{CC} - V_{SS}|$  decreases, the A/D conversion error increases proportionately.

### 24.5.3 Definitions of A/D Converter Terms

- Resolution

It indicates the level of analog variation that can be distinguished by the A/D converter.

When the number of bits is 10, analog voltage can be divided into  $2^{10} = 1024$ .

- Linearity error (unit: LSB)

It indicates how much an actual conversion value deviates from the straight line connecting the zero transition point (“0000000000” ← → “0000000001”) of a device to the full-scale transition point (“1111111111” ← → “1111111110”) of the same device.

- Differential linear error (unit: LSB)

It indicates how much the input voltage required to change the output code by 1 LSB deviates from an ideal value.

- Total error (unit: LSB)

It indicates the difference between an actual value and a theoretical value. The error can be caused by a zero transition error, a full-scale transition errors, a linearity error, a quantum error, or noise.

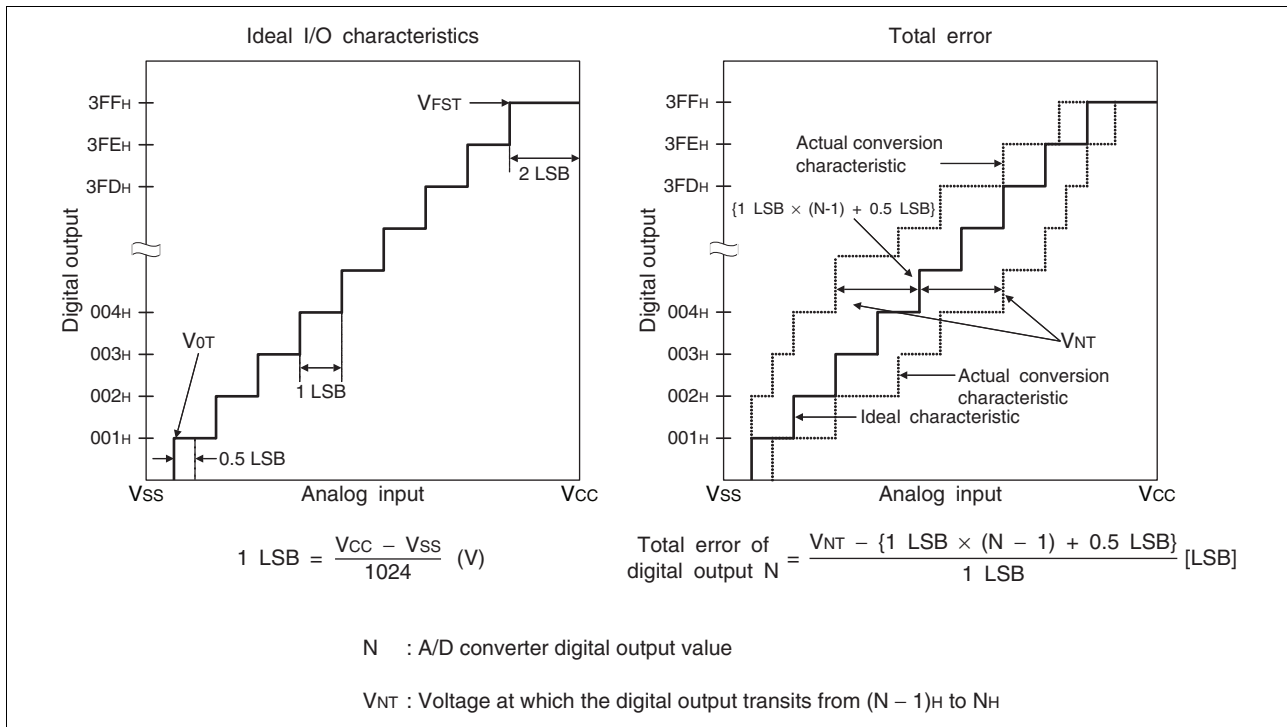





**24.6 Flash Memory Program/Erase Characteristics**

Parameter	Value			Unit	Remarks
	Min	Typ	Max		
Sector erase time (2 Kbyte sector)	—	0.3*1	1.6*2	s	The time of writing 00 <sub>H</sub> prior to erasure is excluded.
Sector erase time (16 Kbyte sector)	—	0.6*1	3.1*2	s	The time of writing 00 <sub>H</sub> prior to erasure is excluded.
Byte writing time	—	17	272	μs	System-level overhead is excluded.
Program/erase cycle	100000	—	—	cycle	
Power supply voltage at program/erase	2.4	—	5.5	V	
Flash memory data retention time	5*3	—	—	year	Average T <sub>A</sub> = +85 °C

\*1: V<sub>CC</sub> = 5.5 V, T<sub>A</sub> = +25 °C, 0 cycle

\*2: V<sub>CC</sub> = 2.4 V, T<sub>A</sub> = +85 °C, 100000 cycles

\*3: This value was converted from the result of a technology reliability assessment. (The value was converted from the result of a high temperature accelerated test using the Arrhenius equation with an average temperature of +85 °C).

## 25. Sample Characteristics

- Power supply current temperature characteristics

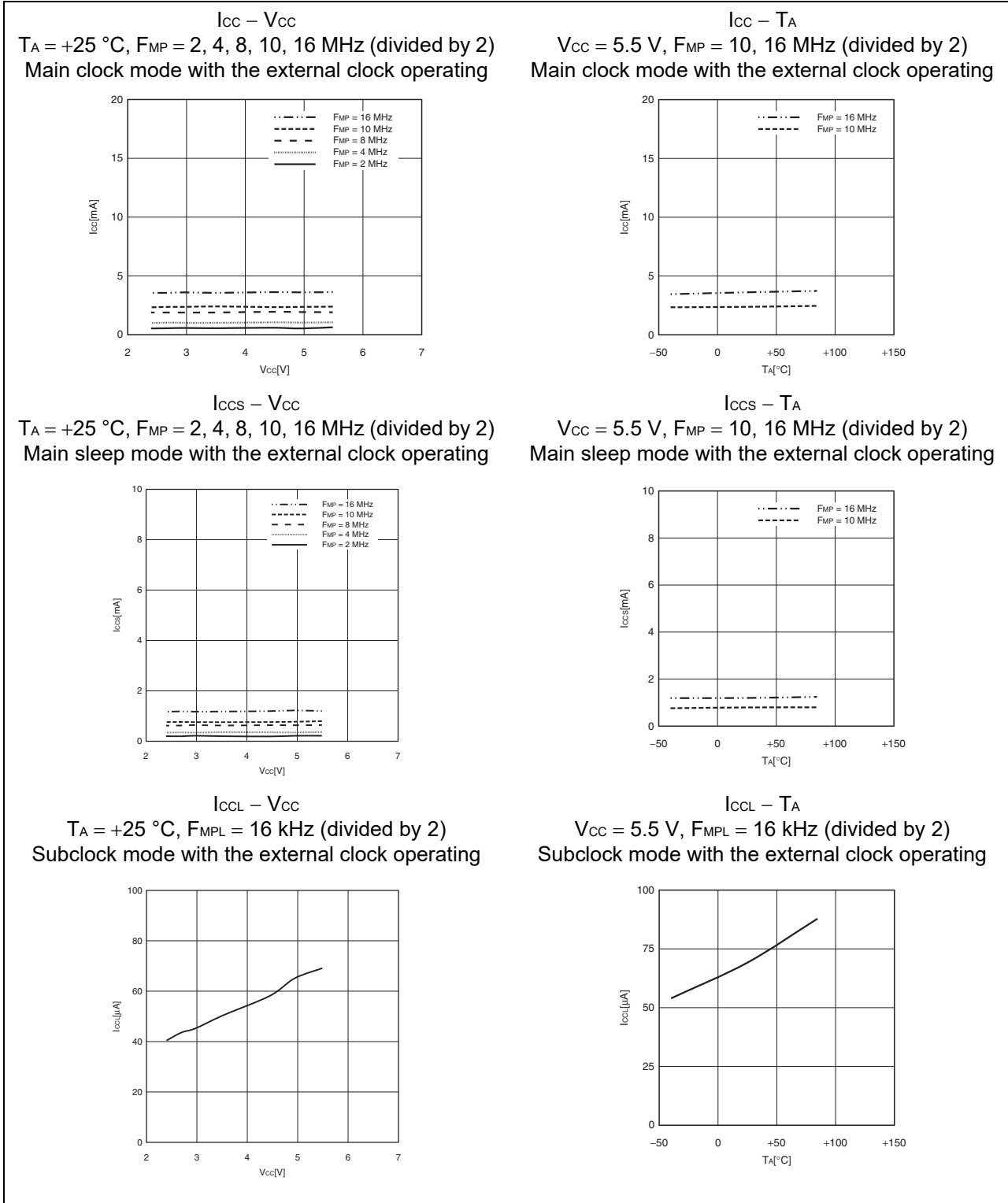



**$I_{CCLS} - V_{CC}$**

$T_A = +25\text{ }^\circ\text{C}$ ,  $F_{MPL} = 16\text{ kHz}$  (divided by 2)  
 Subsleep mode with the external clock operating

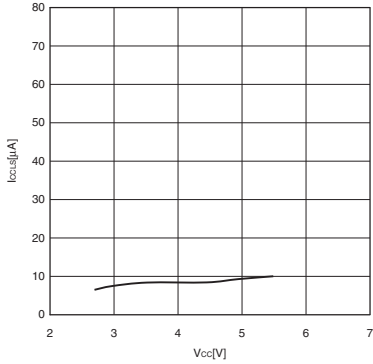

**$I_{CCLS} - T_A$**

$V_{CC} = 5.5\text{ V}$ ,  $F_{MPL} = 16\text{ kHz}$  (divided by 2)  
 Subsleep mode with the external clock operating

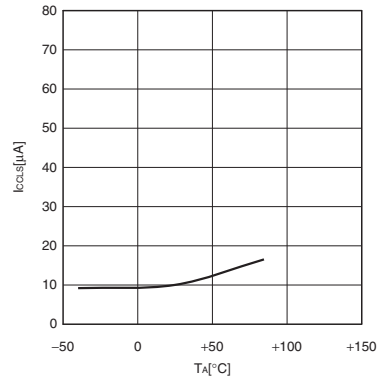

**$I_{CCT} - V_{CC}$**

$T_A = +25\text{ }^\circ\text{C}$ ,  $F_{MPL} = 16\text{ kHz}$  (divided by 2)  
 Watch mode with the external clock operating

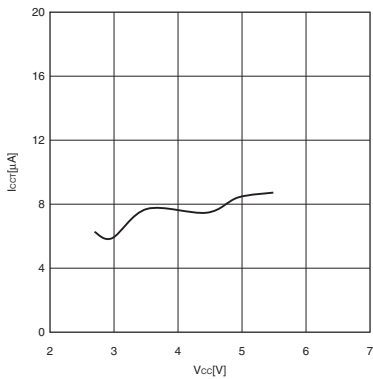

**$I_{CCT} - T_A$**

$V_{CC} = 5.5\text{ V}$ ,  $F_{MPL} = 16\text{ kHz}$  (divided by 2)  
 Watch mode with the external clock operating



**$I_{CCTS} - V_{CC}$**

$T_A = +25\text{ }^\circ\text{C}$ ,  $F_{MP} = 2, 4, 8, 10, 16\text{ MHz}$  (divided by 2)  
 Time-base timer mode with the external clock operating

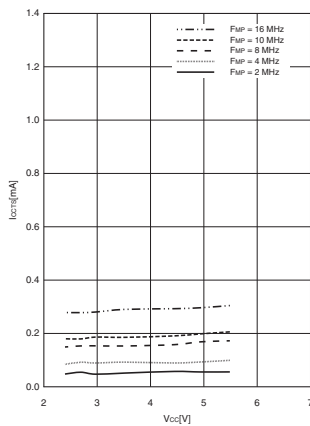

**$I_{CCTS} - T_A$**

$V_{CC} = 5.5\text{ V}$ ,  $F_{MP} = 10, 16\text{ MHz}$  (divided by 2)  
 Time-base timer mode with the external clock operating



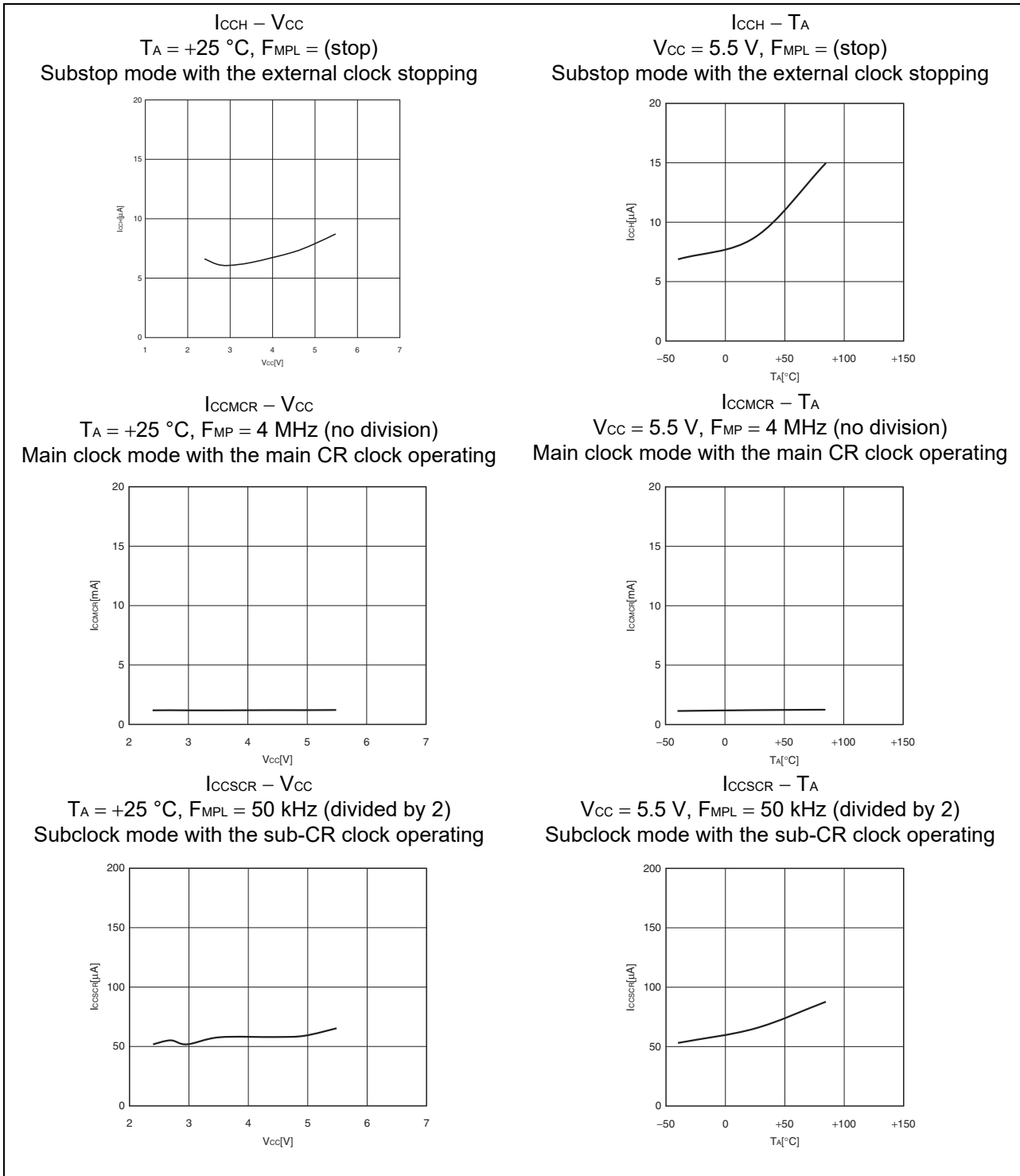



• Input voltage characteristics

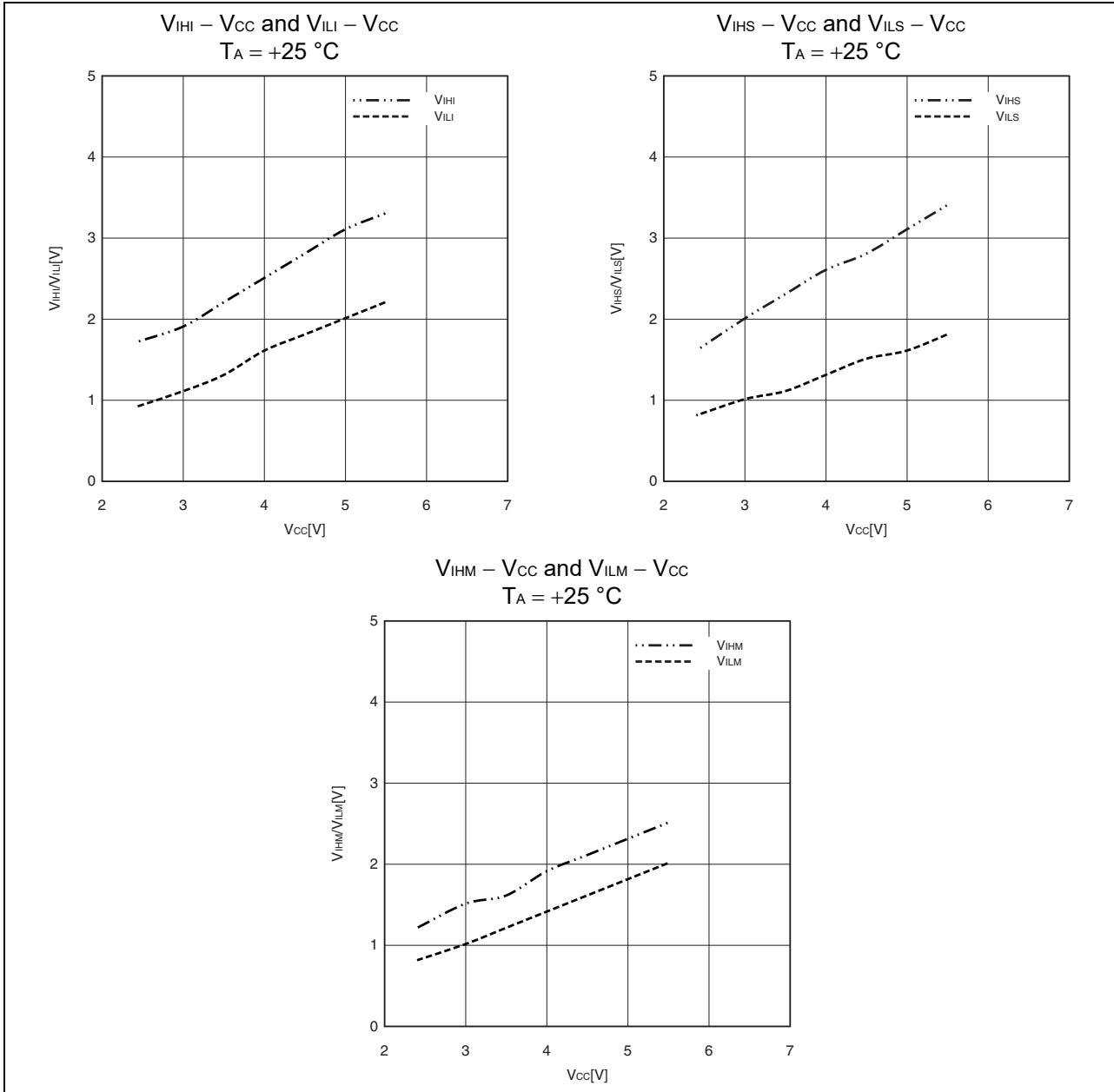



• Output voltage characteristics

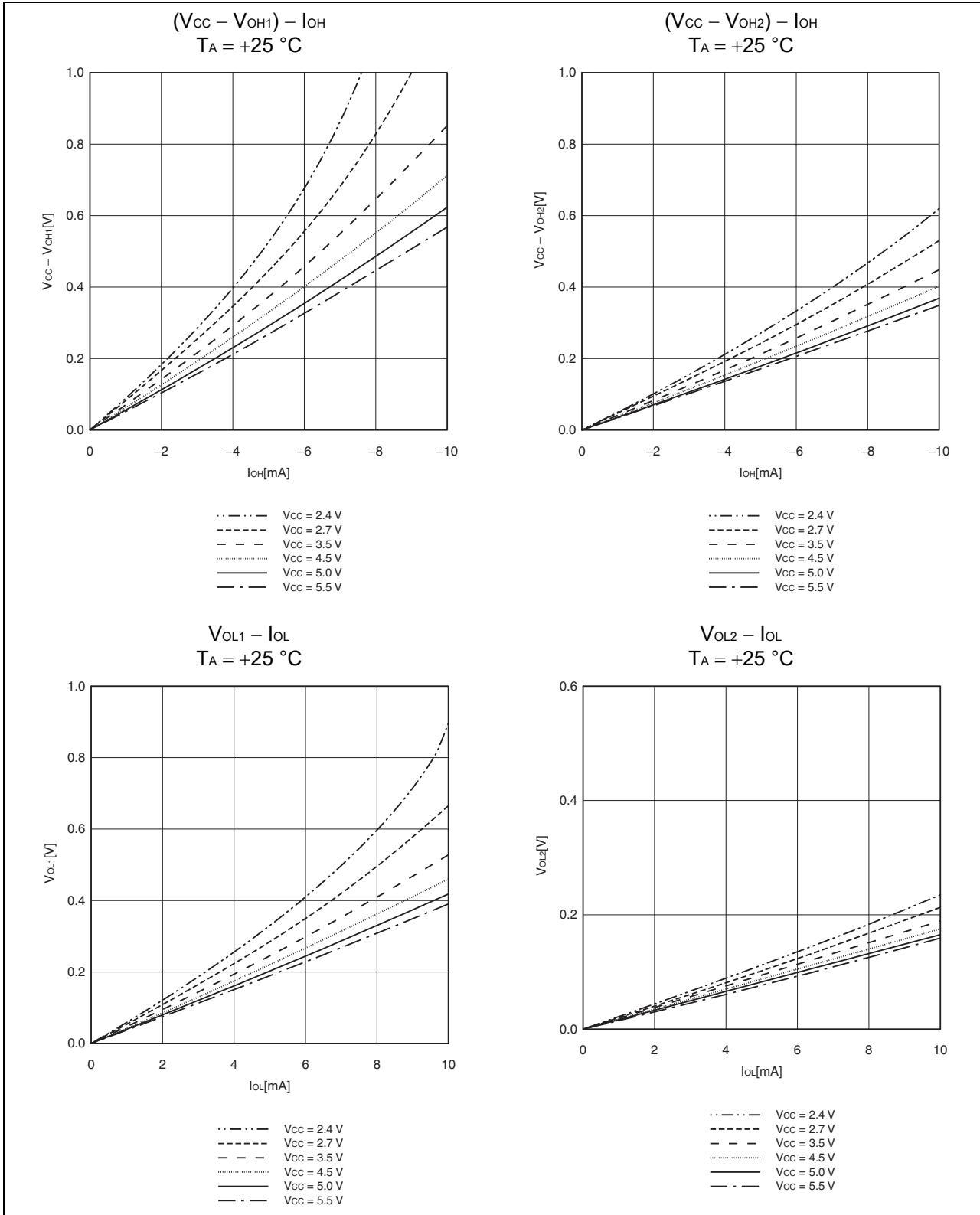



• Pull-up characteristics

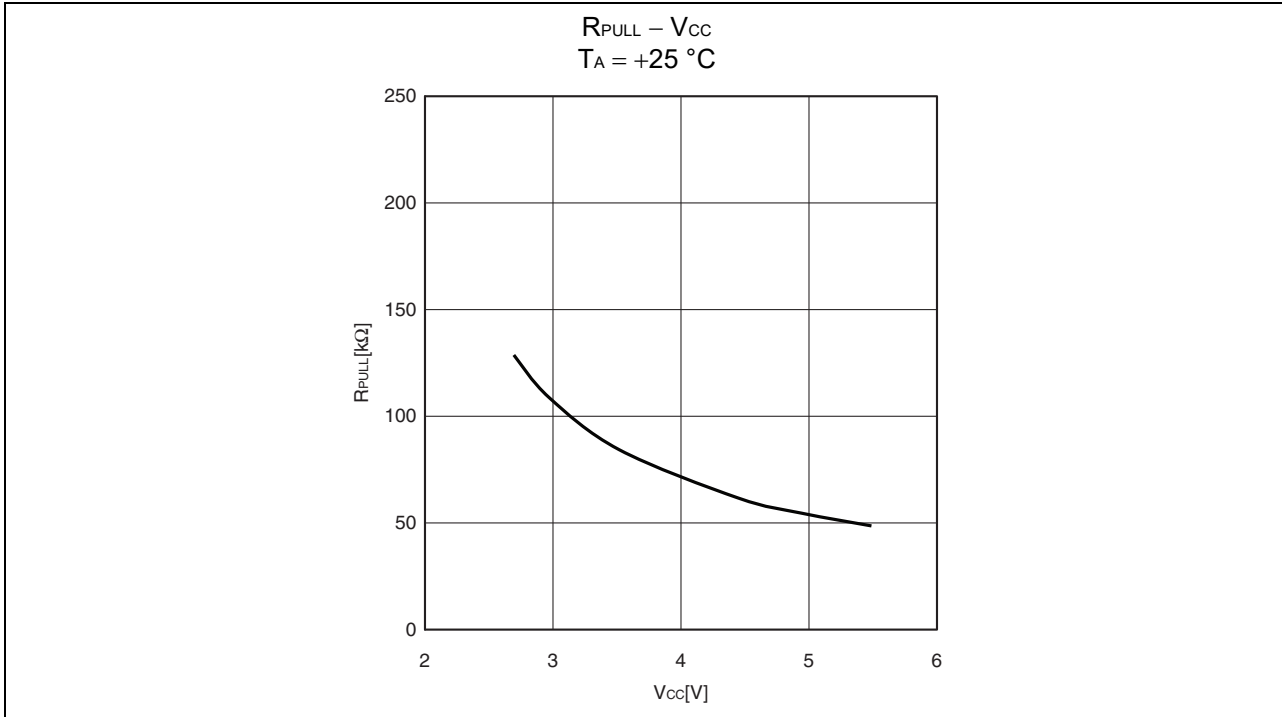

## 26. Mask Options

No.	Part Number	MB95F562H	MB95F562K
		MB95F563H	MB95F563K
		MB95F564H	MB95F564K
		MB95F572H	MB95F572K
		MB95F573H	MB95F573K
		MB95F574H	MB95F574K
		MB95F582H	MB95F582K
		MB95F583H	MB95F583K
		MB95F584H	MB95F584K
<b>Selectable/Fixed</b>		<b>Fixed</b>	
1	Low-voltage detection reset	Without low-voltage detection reset	With low-voltage detection reset
2	Reset	With dedicated reset input	Without dedicated reset input



**27. Ordering Information**

Part number	Package	Packing
MB95F562HWQN-G-SNE1 MB95F562KWQN-G-SNE1 MB95F563HWQN-G-SNE1 MB95F563KWQN-G-SNE1 MB95F564HWQN-G-SNE1 MB95F564KWQN-G-SNE1	32-pin plastic QFN (WNP032)	Tray
MB95F562HWQN-G-SNERE1 MB95F562KWQN-G-SNERE1 MB95F563HWQN-G-SNERE1 MB95F563KWQN-G-SNERE1 MB95F564HWQN-G-SNERE1 MB95F564KWQN-G-SNERE1		Reel
MB95F562HPF-G-SNE2 MB95F562KPF-G-SNE2 MB95F563HPF-G-SNE2 MB95F563KPF-G-SNE2 MB95F564HPF-G-SNE2 MB95F564KPF-G-UNE2	20-pin plastic SOP (SOJ020)	Tube
MB95F562HPFT-G-SNE2 MB95F562KPFT-G-SNE2 MB95F563HPFT-G-SNE2 MB95F563KPFT-G-SNE2 MB95F564HPFT-G-SNE2 MB95F564KPFT-G-UNE2	20-pin plastic TSSOP (STG020)	Tube
MB95F562KPFT-G-UNERE2 MB95F563HPFT-G-UNERE2 MB95F563KPFT-G-UNERE2 MB95F564KPFT-G-UNERE2		Reel
MB95F582HWQN-G-SNE1 MB95F582KWQN-G-SNE1 MB95F583HWQN-G-SNE1 MB95F583KWQN-G-SNE1 MB95F584HWQN-G-SNE1 MB95F584KWQN-G-SNE1	32-pin plastic QFN (WNP032)	Tray
MB95F582HWQN-G-SNERE1 MB95F582KWQN-G-SNERE1 MB95F583HWQN-G-SNERE1 MB95F583KWQN-G-SNERE1 MB95F584HWQN-G-SNERE1 MB95F584KWQN-G-SNERE1		Reel
MB95F582HPFT-G-SNE2 MB95F582KPFT-G-SNE2 MB95F583HPFT-G-SNE2 MB95F583KPFT-G-SNE2 MB95F584HPFT-G-SNE2 MB95F584KPFT-G-SNE2	16-pin plastic TSSOP (STB016)	Tube



Part number	Package	Packing
MB95F582HPF-G-SNE2 MB95F582KPF-G-SNE2 MB95F583HPF-G-SNE2 MB95F583KPF-G-SNE2 MB95F584HPF-G-SNE2 MB95F584KPF-G-SNE2	16-pin plastic SOP (SO016)	Tube
MB95F572HPH-G-SNE2 MB95F572KPH-G-SNE2 MB95F573HPH-G-SNE2 MB95F573KPH-G-SNE2 MB95F574HPH-G-SNE2 MB95F574KPH-G-SNE2	8-pin plastic DIP (PDA008)	Tube
MB95F572HPF-G-SNE2 MB95F572KPF-G-SNE2 MB95F573HPF-G-SNE2 MB95F573KPF-G-SNE2 MB95F574HPF-G-SNE2 MB95F574KPF-G-SNE2	8-pin plastic SOP (SOD008)	Tube

## 28. Package Dimension

Package Type	Package Code
QFN 32	WNP032

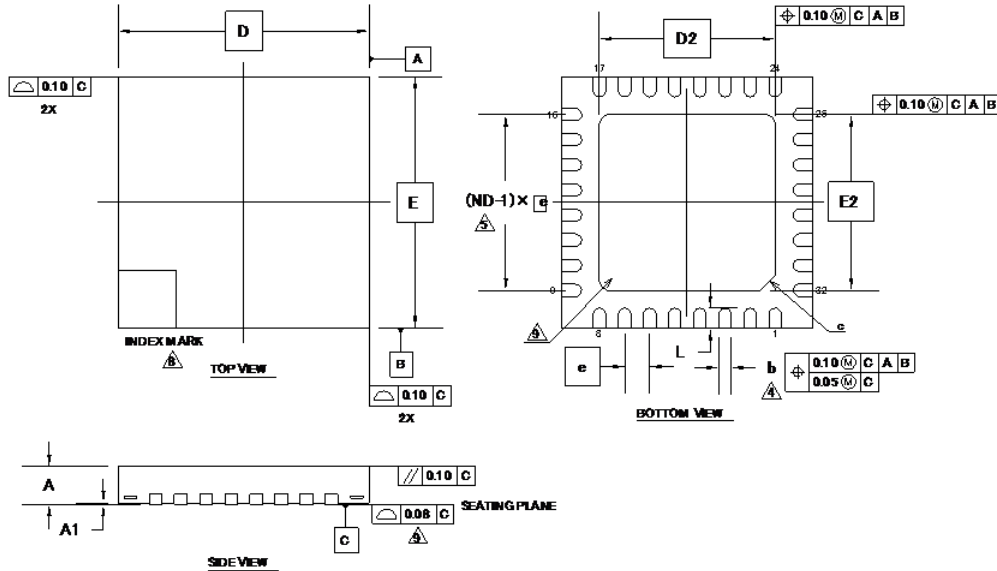

SYMBOL	DIMENSIONS		
	MIN.	NOM.	MAX.
A	—	—	0.80
A1	0.00	—	0.05
D	5.00 BSC		
E	5.00 BSC		
b	0.18	0.25	0.30
D2	3.50 BSC		
E2	3.50 BSC		
e	0.50 BSC		
c	0.30 REF		
L	0.35	0.40	0.45

### NOTE

- ALL DIMENSIONS ARE IN MILLIMETERS
- DIMENSIONING AND TOLERANCING CONFORMS TO ASME Y14.5-1994.
- N IS THE TOTAL NUMBER OF TERMINALS.
- $\Delta$  DIMENSION "b" APPLIES TO METALLIZED TERMINAL AND IS MEASURED BETWEEN 0.15 AND 0.30mm FROM TERMINAL TIP IF THE TERMINAL HAS THE OPTIONAL RADIUS ON THE OTHER END OF THE TERMINAL THE DIMENSION "b" SHOULD NOT BE MEASURED IN THAT RADIUS AREA.
- $\Delta$  ND REFER TO THE NUMBER OF TERMINALS ON D OR E SIDE.
- MAX. PACKAGE WARPAGE IS 0.05mm.
- MAXIMUM ALLOWABLE BURRS IS 0.076mm IN ALL DIRECTIONS.
- $\Delta$  PIN #1 ID ON TOP WILL BE LOCATED WITHIN INDICATED ZONE.
- $\Delta$  BILATERAL COPLANARITY ZONE APPLIES TO THE EXPOSED HEAT SINK SLUG AS WELL AS THE TERMINALS.
- JEDEC SPECIFICATION NO. REF: N/A

PACKAGE OUTLINE 32LEAD QFN  
 5.000.000.8MM WNP032 3.53.3MM EPAD(S) ANV REV\*\*

002-15160 \*\*

Package Type	Package Code
SOP 20	SOJ020

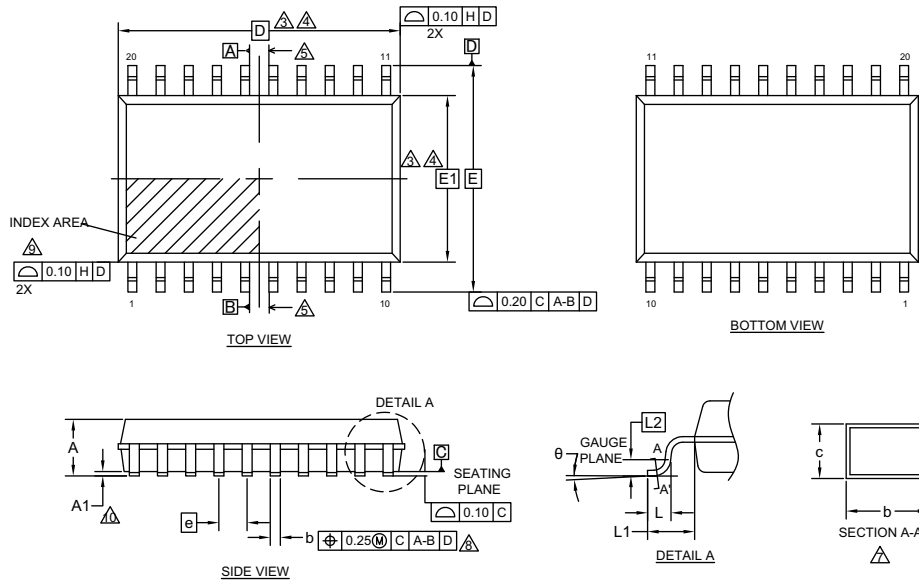

SYMBOL	DIMENSIONS		
	MIN.	NOM.	MAX.
A	—	—	2.65
A1	0.05	—	0.20
D	12.70 BSC		
E	10.20 BSC		
E1	7.50 BSC		
$\theta$	0°	—	8°
c	0.22	—	0.32
b	0.35	0.40	0.49
L	0.50	0.80	1.27
L 1	1.35 REF		
L 2	0.25 BSC		
e	1.27 BSC		

**NOTES**

- ALL DIMENSIONS ARE IN MILLIMETER.
- DIMENSIONING AND TOLERANCING PER ASME Y14.5M-1994.
- DIMENSIONING D INCLUDE MOLD FLASH, DIMENSIONING E1 DOES NOT INCLUDE INTERLEAD FLASH OR PROTRUSION. INTERLEAD FLASH OR PROTRUSIONS SHALL NOT EXCEED 0.025 mm PER SIDE. D and E1 DIMENSION ARE DETERMINED AT DATUM H.
- THE PACKAGE TOP MAY BE SMALLER THAN THE PACKAGE BOTTOM. DIMENSIONING D and E1 ARE DETERMINED AT THE OUTERMOST EXTREMES OF THE PLASTIC BODY EXCLUSIVE OF MOLD FLASH, THE BAR BURRS, GATE BURRS AND INTERLEAD FLASH, BUT INCLUDING ANY MISMATCH BETWEEN THE TOP AND BOTTOM OF THE PLASTIC BODY.
- DATUMS A & B TO BE DETERMINED AT DATUM H.
- "N" IS THE MAXIMUM NUMBER OF TERMINAL POSITIONS FOR THE SPECIFIED PACKAGE LENGTH.
- THE DIMENSION APPLY TO THE FLAT SECTION OF THE LEAD BETWEEN 0.10 mm TO 0.25mm FROM THE LEAD TIP.
- DIMENSION "b" DOES NOT INCLUDE THE DAMBAR PROTRUSION. ALLOWABLE DAMBAR PROTRUSION SHALL BE 0.10mm TOTAL IN EXCESS OF THE "b" DIMENSION AT MAXIMUM MATERIAL CONDITION. THE DAMBAR MAY NOT BE LOCATED ON THE LOWER RADIUS OF THE FOOT.
- THIS CHAMFER FEATURE IS OPTIONAL. IF IT IS NOT PRESENT, THEN A PIN 1 IDENTIFIER MUST BE LOCATED WITHIN THE INDEX AREA INDICATED
- "A1" IS DEFINED AS THE VERTICAL DISTANCE FROM THE SEATING PLANE TO THE LOWEST POINT ON THE PACKAGE BODY EXCLUDING THE LID AND OR THERMAL ENHANCEMENT ON CAVITY DOWN PACKAGE CONFIGURATIONS.
- JEDEC SPECIFICATION NO. REF : N/A

002-16348 \*\*

<b>Package Type</b>	<b>Package Code</b>
TSSOP 20	STG020

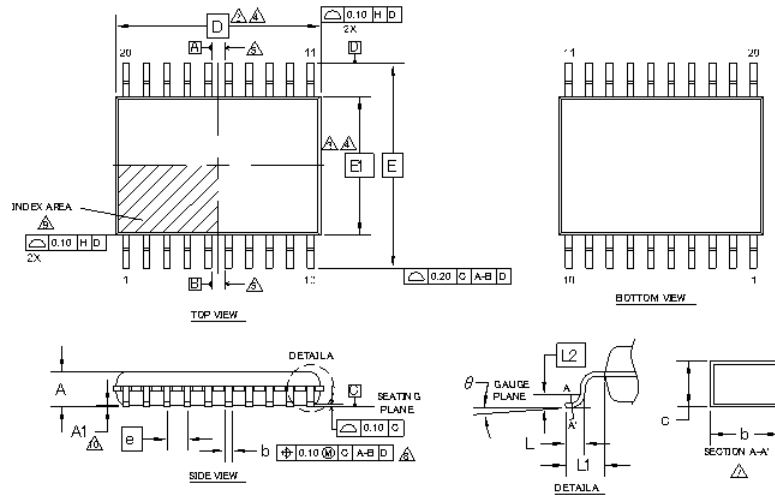

SYMBOL	DIMENSIONS		
	MIN.	NOM.	MAX.
A	—	—	1.20
A1	0.05	—	0.15
D	6.50 BSC		
E	6.40 BSC		
E1	4.40 BSC		
$\theta$	0°	—	8°
c	0.10	—	0.19
b	0.20	0.24	0.28
L	0.45	0.60	0.75
L1	1.00 REF		
L2	0.25 BSC		
e	0.65 BSC		

**NOTES**

- ALL DIMENSIONS ARE IN MILLIMETER.
  - DIMENSIONING AND TOLERANCING PER ASME Y14.5M 1994.
- $\Delta$  DIMENSIONING D INCLUDE MOLD FLASH. DIMENSIONING E1 DOES NOT INCLUDE INTERFAC FLASH OR PROTRUSION. INTERFAC FLASH OR PROTRUSIONS SHALL NOT EXCEED 0.25 mm PER SIDE. D and E1 DIMENSION ARE DETERMINED AT DATUM H.
- $\Delta$  THE PACKAGE TOP MAY BE SMALLER THAN THE PACKAGE BOTTOM. DIMENSIONING D and E1 ARE DETERMINED AT THE OUTERMOST EXTREMES OF THE PLASTIC BODY EXCLUSIVE OF MOLD FLASH, THE BAR BURRS, GATE BURRS AND INTERLEAD FLASH, BUT INCLUDING ANY MISMATCH BETWEEN THE TOP AND BOTTOM OF THE PLASTIC BODY.
- $\Delta$  DATUMS A & B TO BE DETERMINED AT DATUM H.
- $\Delta$  'N' IS THE MAXIMUM NUMBER OF TERMINAL POSITIONS FOR THE SPECIFIED PACKAGE LENGTH.
- $\Delta$  THE DIMENSION APPLY TO THE FLAT SECTION OF THE LEAD BETWEEN 0.10 mm TO 0.25 mm FROM THE LEAD TIP.
- $\Delta$  DIMENSION 'b' DOES NOT INCLUDE THE DAMBAR PROTRUSION. ALLOWABLE DAMBAR PROTRUSION SHALL BE 0.10 mm TOTAL IN EXCESS OF THE 'b' DIMENSION AT MAXIMUM MATERIAL CONDITION. THE DAMBAR MAY NOT BE LOCATED ON THE LOWER RADIUS OF THE FOOT.
- $\Delta$  THIS CHAMFER FEATURE IS OPTIONAL. IF IT IS NOT PRESENT, THEN A PIN 1 IDENTIFIER MUST BE LOCATED WITHIN THE INDEX AREA INDICATED.
- $\Delta$  'A1' IS DEFINED AS THE VERTICAL DISTANCE FROM THE SEATING PLANE TO THE LOWEST POINT ON THE PACKAGE BODY EXCLUDING THE LID AND OR THERMAL ENHANCEMENT ON CARRY DOWN PACKAGE CONFIGURATIONS.
11. JEDEC SPECIFICATION NO. REF: N/A

 PACKAGE OUTLINE, 20 LEAD TSSOP  
 6-2008-40X1.20 MM STG020 REV04

002-15916 \*\*



<b>Package Type</b>	<b>Package Code</b>
TSSOP 16	STB016

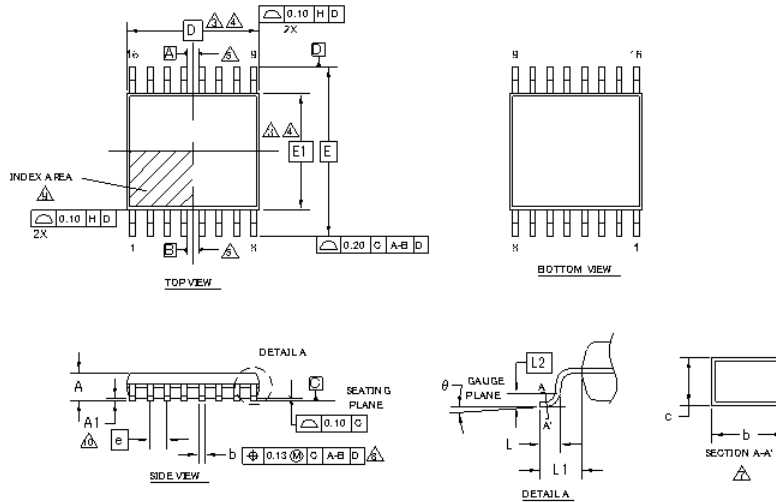

SYMBOL	DIMENSIONS		
	MIN.	NOM.	MAX.
A	—	—	1.20
A1	0.05	—	0.15
D	4.36 BSC		
E	6.40 BSC		
E1	4.40 BSC		
e	0°	—	8°
c	0.10	—	0.19
b	0.16	0.24	0.32
L	0.45	0.60	0.75
L 1	1.00 REF		
L 2	0.25 BSC		
e	0.65 BSC		

**NOTES**

- ALL DIMENSIONS ARE IN MILLIMETER.
  - DIMENSIONING AND TOLERANCING PER ASME Y14.5M 1994.
- ⚠ DIMENSIONING D INCLUDE MOLD FLASH. DIMENSIONING E1 DOES NOT INCLUDE INTERFAD FLASH OR PROTRUSION. INTERFAD FLASH OR PROTRUSIONS SHALL NOT EXCEED 0.025 mm PER SIDE. D and E1 DIMENSION ARE DETERMINED AT DATUM H.
- ⚠ THE PACKAGE TOP MAY BE SMALLER THAN THE PACKAGE BOTTOM. DIMENSIONING D and E1 ARE DETERMINED AT THE OUTERMOST EXTREMES OF THE PLASTIC BODY EXCLUSIVE OF MOLD FLASH, THE BURRS, GATE BURRS AND INTERLEAD FLASH, BUT INCLUDING ANY MISMATCH BETWEEN THE TOP AND BOTTOM OF THE PLASTIC BODY.
- ⚠ DATUMS A & B TO BE DETERMINED AT DATUM H.
- ⚠ "N" IS THE MAXIMUM NUMBER OF TERMINAL POSITIONS FOR THE SPECIFIED PACKAGE LENGTH.
- ⚠ THE DIMENSIONS APPLY TO THE FLAT SECTION OF THE LEAD BETWEEN 0.10 mm TO 0.25 mm FROM THE LEAD TIP.
- ⚠ DIMENSION "b" DOES NOT INCLUDE THE DAMBAR PROTRUSION. ALLOWABLE DAMBAR PROTRUSION SHALL BE 0.10 mm TOTAL IN EXCESS OF THE "b" DIMENSION AT MAXIMUM MATERIAL CONDITION. THE DAMBAR MAY NOT BE LOCATED ON THE LOWER RADIUS OF THE FOOT.
- ⚠ THIS CHAMFER FEATURE IS OPTIONAL. IF IT IS NOT PRESENT, THEN A PIN 1 IDENTIFIER MUST BE LOCATED WITHIN THE INDEX AREA INDICATED.
- ⚠ "A1" IS DEFINED AS THE VERTICAL DISTANCE FROM THE SEATING PLANE TO THE LOWEST POINT ON THE PACKAGE BODY EXCLUDING THE LID AND/OR THERMAL ENHANCEMENT ON CAVITY DOWN PACKAGE CONFIGURATIONS.
11. JEDEC SPECIFICATION NO. REF: N/A

 PACKAGE OUTLINE, 16 LEAD TSSOP  
 4.9x6.40x1.20 MM STB016 REV\*\*

002-15914 \*\*

<b>Package Type</b>	<b>Package Code</b>
SOP 16	SO016

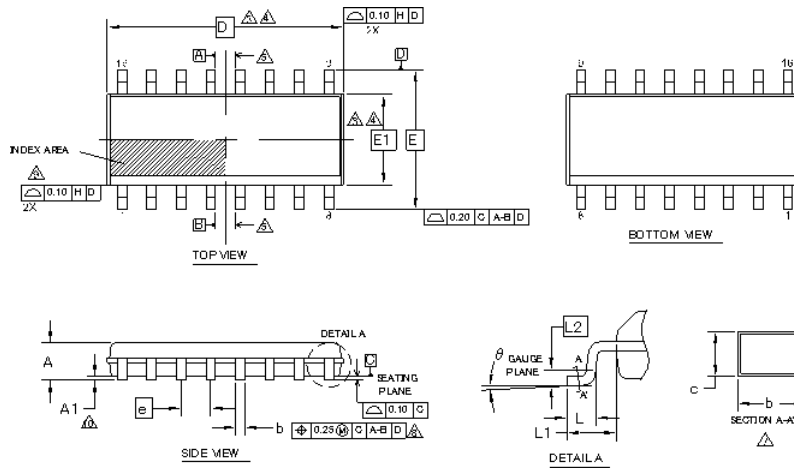

SYMBOL	DIMENSIONS		
	MIN.	NOM.	MAX.
A	—	—	1.75
A1	0.10	—	0.25
D	3.95 BSC		
E	6.00 BSC		
E1	3.90 BSC		
$\theta$	0°	—	8°
c	0.13	—	0.20
b	0.36	0.40	0.51
L	0.45	0.60	0.80
L1	1.05 REF		
L2	0.25 BSC		
e	1.27 BSC		

**NOTES**

- ALL DIMENSIONS ARE IN MILLIMETER.
- DIMENSIONING AND TOLERANCING PER ASME Y14.5M 1994.
- DIMENSIONING D INCLUDE MOLD FLASH. DIMENSIONING E1 DOES NOT INCLUDE INTERFACIAL FLASH OR PROTRUSION. INTERFACIAL FLASH OR PROTRUSIONS SHALL NOT EXCEED 0.025 mm PER SIDE. D and C1 DIMENSION ARE DETERMINED AT DATUM H.
- THE PACKAGE TOP MAY BE SMALLER THAN THE PACKAGE BOTTOM. DIMENSIONING D and E1 ARE DETERMINED AT THE OUTERMOST EXTREMES OF THE PLASTIC BODY EXCLUDING MOLD FLASH, THE BAR BURRS, GATE BURRS AND INTERLEAD FLASH, BUT INCLUDING ANY MISMATCH BETWEEN THE TOP AND BOTTOM OF THE PLASTIC BODY.
- DATUMS A & B TO BE DETERMINED AT DATUM H.
- "N" IS THE MAXIMUM NUMBER OF TERMINAL POSITIONS FOR THE SPECIFIED PACKAGE LENGTH.
- THE DIMENSION APPLY TO THE FLAT SECTION OF THE LEAD BETWEEN 0.10 mm TO 0.25 mm FROM THE LEAD TIP.
- DIMENSION "b" DOES NOT INCLUDE THE DAMBAR PROTRUSION. ALLOWABLE DAMBAR PROTRUSION SHALL BE 0.10mm TOTAL IN EXCESS OF THE "b" DIMENSION AT MAXIMUM MATERIAL CONDITION. THE DAMBAR MAY NOT BE LOCATED ON THE LOWER RADIUS OF THE FOOT.
- THIS CHAMFER FEATURE IS OPTIONAL. IF IT IS NOT PRESENT, THEN A PIN 1 IDENTIFIER MUST BE LOCATED WITHIN THE INDEX AREA INDICATED.
- "A1" IS DEFINED AS THE VERTICAL DISTANCE FROM THE SEATING PLANE TO THE LOWEST POINT ON THE PACKAGE BODY EXCLUDING THE LID AND OR THERMAL ENHANCEMENT ON CAVITY DOWN PACKAGE CONFIGURATIONS.
- JEDEC SPECIFICATION NO. REF: N/A

 PACKAGE OUTLINE, 16 LEAD SOP  
 5.9x2.00x1.75 MM SO016 REV\*\*

002-15861 \*\*

<b>Package Type</b>	<b>Package Code</b>
DIP 8	PDA008

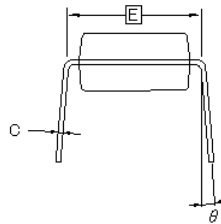
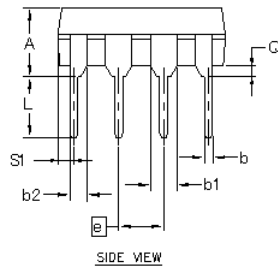
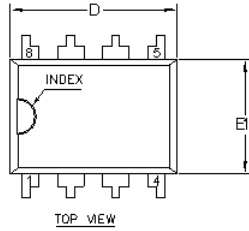

SYMBOL	DIMENSIONS		
	MIN.	NOM.	MAX.
A	—	—	4.26
L	3.00	—	—
D	9.10	9.40	9.80
E	7.62 TYP		
E1	6.10	6.35	6.60
$\theta$	—	—	15°
c	0.20	0.25	0.30
b	0.38	0.46	0.54
b1	—	1.52	1.82
b2	—	0.89	1.29
e	2.54 TYP		
S1	0.59	0.89	1.24
Q	0.50	—	—

**NOTES**

1. ALL DIMENSIONS ARE IN MILLIMETER.
2. JEDEC SPECIFICATION NO. REF : N/A

PACKAGE OUTLINE & LEAD FOOT  
 9-4008-15/12.98 MM PDA008 REV.04

002-16909 \*\*

<b>Package Type</b>	<b>Package Code</b>
SOP 8	SOD008

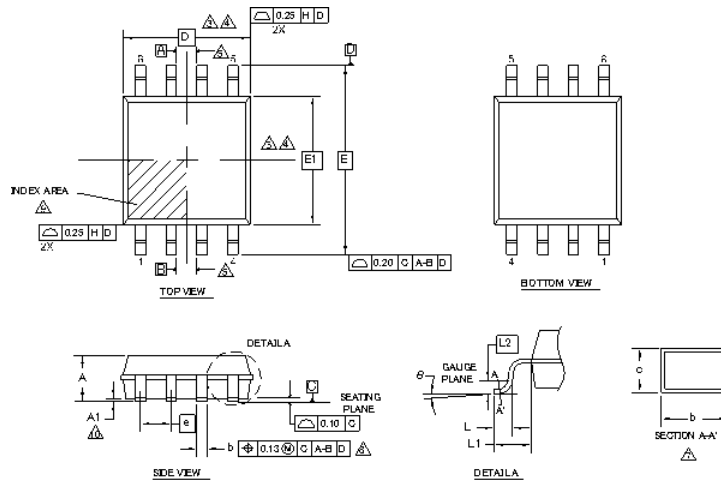

SYMBOL	DIMENSION		
	MIN.	NOM.	MAX.
A	—	—	2.10
A1	0.05	—	0.25
D	5.24 BSC		
E	7.80 BSC		
E1	5.30 BSC		
θ	0°	—	8°
c	0.15	—	0.25
b	0.38	0.43	0.48
L1	1.25 REF		
L2	0.25 BSC		
e	1.27 BSC		

**NOTES**

- ALL DIMENSIONS ARE IN MILLIMETER.
- DIMENSIONING AND TOLERANCING PER ASME Y14.5M '984.
- DIMENSIONING D INCLUDE VOID FLASH, DIMENSIONING E1 DOES NOT INCLUDE INTERFAD FLASH OR PROTRUSION. INTERFAD FLASH OR PROTRUSIONS SHALL NOT EXCEED 0.025mm PER SIDE. D and E1 DIMENSION ARE DETERMINED AT DATUM H.
- IHL PACKAGE TOP MAY BE SMALLER THAN IFL PACKAGE BOTTOM. DIMENSIONING D and E1 ARE DETERMINED AT THE OUTERMOST EXTREMES OF THE PLASTIC BODY EXCLUDING MOULD FLASH, THE BAR BURRS, GATE BURRS AND INTERLEAD FLASH, BUT INCLUDING ANY MISMATCH BETWEEN THE TOP AND BOTTOM OF THE PLASTIC BODY.
- DATUMS A & B TO BE DETERMINED AT DATUM H.
- N° 3 IS THE MAXIMUM NUMBER OF TERMINAL POSITIONS FOR THE SPECIFIED PACKAGE LENGTH.
- THE DIMENSION APPLY TO THE FLAT SECTION OF THE LEAD BETWEEN 0.19mm TO 0.25mm FROM THE LEAD TIP.
- DIMENSION "b" DOES NOT INCLUDE THE DAMBAR PROTRUSION. ALLOWABLE DAMBAR PROTRUSION SHALL BE 0.19mm TOTAL IN EXCESS OF "b" DIMENSION AT MAXIMUM MATERIAL CONDITION. THE DAMBAR MAY NOT BE LOCATED ON THE LOWER RADIUS OF THE FOOT.
- THE 3° CHAMFER FEATURE IS OPTIONAL. IF IT IS NOT PRESENT, THEN A PIN 1 IDENTIFIER MUST BE LOCATED WITHIN THE INDEX AREA INDICATED.
- "A1" IS DEFINED AS THE VERTICAL DISTANCE FROM THE SEATING PLANE TO THE LOWEST POINT ON THE PACKAGE BODY EXCLUDING THE LEAD AND OR THERMAL ENHANCEMENT ON CAVITY DOWN PACKAGE CONFIGURATIONS.
- UNLESS SPECIFICATION NO. REF: N/A

PACKAGE OUTLINE, 8 LEAD SOP  
 5240730/02, 10 MM, SOD008 REV.0\*

002-15858 \*\*



## 29. Major Changes In This Edition

Spanion Publication Number: DS702-00010

Page	Section	Details
—	—	<p>Changed the series name.            MB95560H Series → MB95560H/570H/580H Series</p> <p>Added information on the MB95570H Series.</p> <p>Added information on the MB95580H Series.</p>
27	<ul style="list-style-type: none"> <li>■ PIN CONNECTION</li> <li>• DBG pin</li> </ul>	Revised details of “• DBG pin”.
	<ul style="list-style-type: none"> <li>• <math>\overline{\text{RST}}</math> pin</li> </ul>	Revised details of “• $\overline{\text{RST}}$ pin”.
28	<ul style="list-style-type: none"> <li>• C pin</li> </ul>	<p>Corrected the following statement.            The decoupling capacitor for the <math>V_{CC}</math> pin must have a capacitance larger than <math>C_s</math>.            →            The decoupling capacitor for the <math>V_{CC}</math> pin must have a capacitance equal to or larger than the capacitance of <math>C_s</math>.</p>
39	<ul style="list-style-type: none"> <li>■ I/O MAP (MB95570H Series)</li> </ul>	<p>Corrected the R/W attribute of the CMDR register.            R/W → R</p> <p>Corrected the R/W attribute of the WDTM register.            R/W → R</p> <p>Corrected the R/W attribute of the WDTL register.            R/W → R</p>
42	<ul style="list-style-type: none"> <li>■ I/O MAP (MB95580H Series)</li> </ul>	<p>Corrected the R/W attribute of the CMDR register.            R/W → R</p> <p>Corrected the R/W attribute of the WDTM register.            R/W → R</p> <p>Corrected the R/W attribute of the WDTL register.            R/W → R</p>
46	<ul style="list-style-type: none"> <li>■ ELECTRICAL CHARACTERISTICS</li> <li>1. Absolute Maximum Ratings</li> </ul>	<p>Corrected the rating of the parameter ““L” level total maximum output current”.            48 → 100</p> <p>Corrected the rating of the parameter ““H” level total maximum output current”.            48 → -100</p>



Page	Section	Details
48	2. Recommended Operating Conditions	Revised note *2. The value is 2.88 V when the low-voltage detection reset is used. → The minimum power supply voltage becomes 2.18 V when a product with the low-voltage detection reset is used.
		Corrected the following statement in note *3. The decoupling capacitor for the V <sub>CC</sub> pin must have a capacitance larger than C <sub>s</sub> . → The decoupling capacitor for the V <sub>CC</sub> pin must have a capacitance equal to or larger than the capacitance of C <sub>s</sub> .
		Revised the remark in “• DBG/RST/C pins connection diagram”.
49	3. DC Characteristics	Revised the remark of the parameter “Input leak current (Hi-Z output leak current)”. When pull-up resistance is disabled → When the internal pull-up resistor is disabled
		Renamed the parameter “Pull-up resistance” to “Internal pull-up resistor”.
		Revised the remark of the parameter “Internal pull-up resistor”. When pull-up resistance is enabled → When the internal pull-up resistor is enabled
53	4. AC Characteristics (1) Clock Timing	Corrected the pin names of the parameter “Input clock rising time and falling time”. X0 → X0, X0A X0, X1 → X0, X1, X0A, X1A



- Major changes from third edition to fourth edition

Page	Section	Details
23 to 26	■ HANDLING PRECAUTIONS	New section
35	■ I/O MAP (MB95560H Series)	Corrected the R/W attribute of the CMDR register. R/W → R
52	<b>■ ELECTRICAL CHARACTERISTICS</b> 4. AC Characteristics (1) Clock Timing	Corrected the operating conditions of $F_{CRH}$ of the parameter "Clock frequency". $0\text{ }^{\circ}\text{C} \leq T_A < +70\text{ }^{\circ}\text{C}$ → $0\text{ }^{\circ}\text{C} \leq T_A \leq +70\text{ }^{\circ}\text{C}$  $+70\text{ }^{\circ}\text{C} \leq T_A < +85\text{ }^{\circ}\text{C}$ → $+70\text{ }^{\circ}\text{C} \leq T_A \leq +85\text{ }^{\circ}\text{C}$
		Corrected the operating conditions of $F_{MCRPLL}$ of the parameter "Clock frequency". $0\text{ }^{\circ}\text{C} \leq T_A < +70\text{ }^{\circ}\text{C}$ → $0\text{ }^{\circ}\text{C} \leq T_A \leq +70\text{ }^{\circ}\text{C}$  $+70\text{ }^{\circ}\text{C} \leq T_A < +85\text{ }^{\circ}\text{C}$ → $+70\text{ }^{\circ}\text{C} < T_A \leq +85\text{ }^{\circ}\text{C}$
68	5. A/D Converter (1) A/D Converter Electrical Characteristics	Corrected the symbol of the parameter "Zero transition voltage". $V_{OT} \rightarrow V_{0T}$
69	5. A/D Converter (2) Notes on Using A/D Converter • Analog input equivalent circuit	Corrected the range of $V_{CC}$ . $2.7\text{ V} \leq V_{CC} < 5.5\text{ V}$ → $2.7\text{ V} \leq V_{CC} < 4.5\text{ V}$
		Corrected the values of R. $3.3\text{ k}\Omega \rightarrow 1.45\text{ k}\Omega$ $5.7\text{ k}\Omega \rightarrow 2.7\text{ k}\Omega$
70, 71	5. A/D Converter (3) Definitions of A/D Converter Terms	Corrected the symbol of the zero transition voltage. $V_{OT} \rightarrow V_{0T}$

NOTE: Please see "Document History" about later revised information.



**Document History Page**

Document Title: MB95560H Series/MB95570H Series/MB95580H Series, New 8FX 8-bit Microcontrollers Document Number: 002-04629				
Revision	ECN	Orig. of Change	Submission Date	Description of Change
**	-	AKIH	05/27/2013	Migrated to Cypress and assigned document number 002-04629. No change to document contents or format.
*A	5193921	AKIH	03/29/2016	Updated 24.4.3 External Reset Added MB95F564KPF-G-UNE2, MB95F564KPFT-G-UNE2 in "Ordering Information". Updated to Cypress template.
*B	5420206	HTER	02/06/2017	Changed package code as the following in 1.Product Line-up (Page4, 6), 2.Packages And Corresponding Products (Page 7), 4.Pin Assignment (Page 9 to 10), 27.Ordering Information (Page 75 to 76) and 28.Package Dimensions (Page 77 to 83). "LCC-32P-M19" to "WNP032" "FPT-20P-M09" to "SOJ020" "FPT-20P-M10" to "STG020" "FPT-16P-M08" to "STB016" "FPT-16P-M23" to "SO016" "DIP-8P-M03" to "PDA008" "FPT-8P-M08" to "SOD008" Added Part number "MB95F564KPFT-G-UNERE2, MB95F562KPFT-G-UNERE2, MB95F563KPFT-G-UNERE2" in 27.Ordering Information (Page 75). Deleted Part number "MB95F564KPF-G-SNE2, MB95F564KPFT-G-SNE2" in 27.Ordering Information (Page 75).
*C	5761469	AESATP12	06/08/2017	Updated logo and copyright.
*D	5895915	HUAL	09/27/2017	Added Part number "MB95F563HPFT-G-UNERE2" and Packing information in 27.Ordering Information (Page 75).
*E	5972828	HUAL	11/21/2017	Updated Package Dimension: Updated Diagram corresponding to "SOP 20".





## Sales, Solutions, and Legal Information

### Worldwide Sales and Design Support

Cypress maintains a worldwide network of offices, solution centers, manufacturer's representatives, and distributors. To find the office closest to you, visit us at [Cypress Locations](#).

#### Products

ARM® Cortex® Microcontrollers	<a href="http://cypress.com/arm">cypress.com/arm</a>
Automotive	<a href="http://cypress.com/automotive">cypress.com/automotive</a>
Clocks & Buffers	<a href="http://cypress.com/clocks">cypress.com/clocks</a>
Interface	<a href="http://cypress.com/interface">cypress.com/interface</a>
Internet of Things	<a href="http://cypress.com/iot">cypress.com/iot</a>
Memory	<a href="http://cypress.com/memory">cypress.com/memory</a>
Microcontrollers	<a href="http://cypress.com/mcu">cypress.com/mcu</a>
PSoC	<a href="http://cypress.com/psoc">cypress.com/psoc</a>
Powermanagement ICs	<a href="http://cypress.com/pmic">cypress.com/pmic</a>
Touch Sensing	<a href="http://cypress.com/touch">cypress.com/touch</a>
USB Controllers	<a href="http://cypress.com/usb">cypress.com/usb</a>
Wireless/Connectivity	<a href="http://cypress.com/wireless">cypress.com/wireless</a>

#### PSoC® Solutions

[PSoC 1](#) | [PSoC 3](#) | [PSoC 4](#) | [PSoC 5LP](#) | [PSoC 6](#)

#### Cypress Developer Community

[Forums](#) | [WICED IOT Forums](#) | [Projects](#) | [Video](#) | [Blogs](#) | [Training](#) | [Components](#)

#### Technical Support

[cypress.com/support](http://cypress.com/support)

---

© Cypress Semiconductor Corporation, 2011-2017. This document is the property of Cypress Semiconductor Corporation and its subsidiaries, including Spansion LLC ("Cypress"). This document, including any software or firmware included or referenced in this document ("Software"), is owned by Cypress under the intellectual property laws and treaties of the United States and other countries worldwide. Cypress reserves all rights under such laws and treaties and does not, except as specifically stated in this paragraph, grant any license under its patents, copyrights, trademarks, or other intellectual property rights. If the Software is not accompanied by a license agreement and you do not otherwise have a written agreement with Cypress governing the use of the Software, then Cypress hereby grants you a personal, non-exclusive, nontransferable license (without the right to sublicense) (1) under its copyright rights in the Software (a) for Software provided in source code form, to modify and reproduce the Software solely for use with Cypress hardware products, only internally within your organization, and (b) to distribute the Software in binary code form externally to end users (either directly or indirectly through resellers and distributors), solely for use on Cypress hardware product units, and (2) under those claims of Cypress's patents that are infringed by the Software (as provided by Cypress, unmodified) to make, use, distribute, and import the Software solely for use with Cypress hardware products. Any other use, reproduction, modification, translation, or compilation of the Software is prohibited.

TO THE EXTENT PERMITTED BY APPLICABLE LAW, CYPRESS MAKES NO WARRANTY OF ANY KIND, EXPRESS OR IMPLIED, WITH REGARD TO THIS DOCUMENT OR ANY SOFTWARE OR ACCOMPANYING HARDWARE, INCLUDING, BUT NOT LIMITED TO, THE IMPLIED WARRANTIES OF MERCHANTABILITY AND FITNESS FOR A PARTICULAR PURPOSE. To the extent permitted by applicable law, Cypress reserves the right to make changes to this document without further notice. Cypress does not assume any liability arising out of the application or use of any product or circuit described in this document. Any information provided in this document, including any sample design information or programming code, is provided only for reference purposes. It is the responsibility of the user of this document to properly design, program, and test the functionality and safety of any application made of this information and any resulting product. Cypress products are not designed, intended, or authorized for use as critical components in systems designed or intended for the operation of weapons, weapons systems, nuclear installations, life-support devices or systems, other medical devices or systems (including resuscitation equipment and surgical implants), pollution control or hazardous substances management, or other uses where the failure of the device or system could cause personal injury, death, or property damage ("Unintended Uses"). A critical component is any component of a device or system whose failure to perform can be reasonably expected to cause the failure of the device or system, or to affect its safety or effectiveness. Cypress is not liable, in whole or in part, and you shall and hereby do release Cypress from any claim, damage, or other liability arising from or related to all Unintended Uses of Cypress products. You shall indemnify and hold Cypress harmless from and against all claims, costs, damages, and other liabilities, including claims for personal injury or death, arising from or related to any Unintended Uses of Cypress products.

Cypress, the Cypress logo, Spansion, the Spansion logo, and combinations thereof, WICED, PSoC, CapSense, EZ-USB, F-RAM, and Traveo are trademarks or registered trademarks of Cypress in the United States and other countries. For a more complete list of Cypress trademarks, visit [cypress.com](http://cypress.com). Other names and brands may be claimed as property of their respective owners.

Компания «Океан Электроники» предлагает заключение долгосрочных отношений при поставках импортных электронных компонентов на взаимовыгодных условиях!

Наши преимущества:

- Поставка оригинальных импортных электронных компонентов напрямую с производств Америки, Европы и Азии, а так же с крупнейших складов мира;
- Широкая линейка поставок активных и пассивных импортных электронных компонентов (более 30 млн. наименований);
- Поставка сложных, дефицитных, либо снятых с производства позиций;
- Оперативные сроки поставки под заказ (от 5 рабочих дней);
- Экспресс доставка в любую точку России;
- Помощь Конструкторского Отдела и консультации квалифицированных инженеров;
- Техническая поддержка проекта, помощь в подборе аналогов, поставка прототипов;
- Поставка электронных компонентов под контролем ВП;
- Система менеджмента качества сертифицирована по Международному стандарту ISO 9001;
- При необходимости вся продукция военного и аэрокосмического назначения проходит испытания и сертификацию в лаборатории (по согласованию с заказчиком);
- Поставка специализированных компонентов военного и аэрокосмического уровня качества (Xilinx, Altera, Analog Devices, Intersil, Interpoint, Microsemi, Actel, Aeroflex, Peregrine, VPT, Syfer, Eurofarad, Texas Instruments, MS Kennedy, Miteq, Cobham, E2V, MA-COM, Hittite, Mini-Circuits, General Dynamics и др.);

Компания «Океан Электроники» является официальным дистрибьютором и эксклюзивным представителем в России одного из крупнейших производителей разъемов военного и аэрокосмического назначения «JONHON», а так же официальным дистрибьютором и эксклюзивным представителем в России производителя высокотехнологичных и надежных решений для передачи СВЧ сигналов «FORSTAR».



## JONHON

«JONHON» (основан в 1970 г.)

Разъемы специального, военного и аэрокосмического назначения:

(Применяются в военной, авиационной, аэрокосмической, морской, железнодорожной, горно- и нефтедобывающей отраслях промышленности)

«FORSTAR» (основан в 1998 г.)

ВЧ соединители, коаксиальные кабели, кабельные сборки и микроволновые компоненты:

(Применяются в телекоммуникациях гражданского и специального назначения, в средствах связи, РЛС, а так же военной, авиационной и аэрокосмической отраслях промышленности).



Телефон: 8 (812) 309-75-97 (многоканальный)

Факс: 8 (812) 320-03-32

Электронная почта: [ocean@oceanchips.ru](mailto:ocean@oceanchips.ru)

Web: <http://oceanchips.ru/>

Адрес: 198099, г. Санкт-Петербург, ул. Калинина, д. 2, корп. 4, лит. А