

## Description

The AVO100B-48S3V3 is a single output DC-DC converter with standard eighth-brick outline and pin configuration. It delivers up to 30A output current with 3.3V output voltage. Above 92.5% ultra-high efficiency and excellent thermal performance make it an ideal choice to supply power in telecom and datacom. It can work under  $-40^{\circ}\text{C} \sim +85^{\circ}\text{C}$  with air cooling.

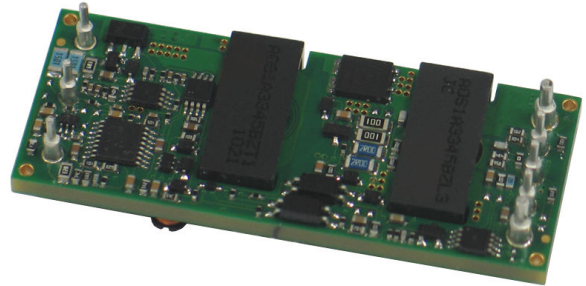

## Operational Features

- Delivers up to 30A output current
- Ultra-high efficiency 92.5% typ. at half load
- Wide input range: 36V ~ 75V
- Excellent thermal performance
- No minimum load requirement
- RoHS 5 compliant

## Control Features

- Remote control function (negative or positive logic optional)
- Remote output sense
- Trim function: 80% ~ 110%

## Protection Features

- Input under-voltage lockout
- Output over-current protection
- Output over-voltage protection
- Over-temperature protection

## Mechanical Features

- Industry standard eighth-brick pin-out outline
- Open frame
- Pin length option: 3.8mm

## Safety & EMC

- Meets basic insulation requirements of IEC/EN/UL/CSA 60950
- UL/CSA 60950 recognized and certified to IEC/EN 60950
- Meets the Low Voltage directives 2006/95/EEC with the Amendment Directive 93/68/EEC which facilitates CE marking in user's end product
- Approved by UL and TUV
- Materials meet UL94,V-0 flammability rating
- Meets conducted emission's requirements of EN55022 Class A with external filter

## Electrical Characteristics

Full operating ambient temperature range is -40°C to +85°C.

Specifications are subject to change without notice.

Parameter		Min.	Typ.	Max.	Unit	Notes & conditions
<b>Absolute max. ratings</b>						
Input voltage	Non-operating			100	V	100ms
	Operating			80	V	Continuous
Operating temperature		-40		+85	°C	
Storage temperature		-55		+125	°C	
Voltage at remote ON/OFF pin		-0.7		12	V	
<b>Input characteristics</b>						
Operating input voltage range		35	48	75	V	
Input under-voltage lockout	Turn-on voltage threshold	31	33.5	36	V	
	Turn-off voltage threshold	30	31.5	35	V	
	Lockout voltage hysteresis	1	2	3	V	
Max. input current			3.05	3.5	A	36V <sub>in</sub> , full load
No-load input current				0.1	A	
Standby input current			0.01	0.1	A	Remote OFF
Inrush current transient rating			0.5	1	A <sup>2</sup> s	See Figure 16
Input reflected ripple current			10	30	mA	See Figure 3 Through 12μH inductor; see Figure 16
Recommended input fuse				6.3	A	External fast blow fuse is recommended; see Figure 11
Input filter component values (C/L)			2\3		μF\μH	Internal values
Recommended external input capacitance			100		μF	Low ESR capacitor is recommended; see Figure 11
<b>Output characteristics</b>						
Output voltage set point (standard option)		3.25	3.3	3.35	V	48V <sub>in</sub> , full load
Output voltage line regulation			0.1	0.24	%	
			3	8	mV	

Parameter	Min.	Typ.	Max.	Unit	Notes & conditions	
Output voltage load regulation		0.15	0.45	%		
		5	15	mV		
Output voltage temperature regulation		0.002	0.02	%/°C		
Total output voltage range	3.2	3.3	3.4	V	Over sample, line, load, temperature & life	
Output voltage ripple and noise		40	120	mVpp	See Figure 2 20MHz bandwidth; see Figure 16	
Operating output current range	0		30	A		
Output DC current-limit inception	33		42	A	Hiccup: auto-restart when over-current condition is removed	
Output capacitance	220		10000	μF	High frequency and low ESR are recommended	
<b>Dynamic characteristics</b>						
Dynamic response	50% ~ 75% ~ 50% $I_{o,max}$ , 0.1A/μs		60		mV	See Figure 4 Test condition: 25°C, nominal input voltage, see Figure 11
	Settling time		70		μs	Recovery to within 1% $V_{o,nom}$
	50% ~ 75% ~ 50% $I_{o,max}$ , 1A/μs		150		mV	See Figure 5 Test condition: 25°C, nominal input voltage, see Figure 11
	Settling time		80		μs	Recovery to within 1% $V_{o,nom}$
Turn-on transient	Rise time		3	30	ms	Full load, see Figure 6
	Turn-on delay time		5	10	ms	
	Output voltage overshoot			0	% $V_o$	
<b>Efficiency</b>						
100% load		92		%	See Figure 1	
50% load		92.5		%	See Figure 1	

## Electrical Characteristics (Continued)

Parameter	Min.	Typ.	Max.	Unit	Notes & conditions	
<b>Isolation characteristics</b>						
Isolation voltage (conditions: 1mA for 60s, slew rate of 1500V/10s)	2000			V	Basic insulation, pollution degree 2, input to output	
<b>Feature characteristics</b>						
Switching frequency		310		kHz		
Remote ON/OFF control (positive logic)	Off-state voltage	-0.7		1.2	V	See Figure 8 and Figure 9
	On-state voltage	3.5		12	V	
Remote ON/OFF control (negative logic)	Off-state voltage	3.5		12	V	
	On-state voltage	-0.7		1.2	V	
Output voltage trim range	2.64		3.63	V	See <i>Trim Characteristics</i> of <i>Application Note</i>	
Output voltage remote sense range			0.33	V		
Output over-voltage protection	115	130	150	%Vo,nom	Hiccup: auto-restart when over-voltage condition is removed	
Over-temperature shutdown	120	130	140	°C	Auto recovery; over-temperature protect (OTP) test point: see Figure 10 Tested under thermal balance condition	
Over-temperature hysteresis	5	20		°C		
<b>Reliability characteristics</b>						
Calculated MTBF (telcordia )		2.5		10 <sup>6</sup> h	Telcordia SR-332-2006; normal Input/Output, 300LFM, 25°C T <sub>a</sub>	

## Electromagnetic Compatibility Requirements

Test item	Regulations	Criteria	Notes & conditions
Conducted emission	EN 55022 DC input port, class A limits	N/A	See EMC test conditions
Immunity to electrostatic discharge	IEC/EN61000-4-2 Enclosure port, level 3	B	
Immunity to electrical fast transient	IEC/EN61000-4-4 DC input port, level 3	B	
Immunity to surges	IEC/EN61000-4-5 DC input port Line to ground(earth): 600V Line to line: 600V	B	
Immunity to continuous conducted interference	IEC/EN61000-4-6 DC input port, level 2	A	
Immunity to voltage dips and short interruptions and voltage variations	EN 61000-4-29 DC input port	B	

Criterion A: Normal performance during and after test.

Criterion B: For EFT and surges, low-voltage protection or reset is not allowed. Temporary output voltage fluctuation ceases after disturbances ceases, from which the EUT recovers its normal performance automatically.

For Dips and ESD, output voltage fluctuation or reset is allowed during the test, but recovers to its normal performance automatically after the disturbance ceases.

Criterion C: Temporary loss of output, the correction of which requires operator intervention.

Criterion D: Loss of output which is not recoverable, owing to damage to hardware.

## Qualification Testing

Parameter	Unit (pcs)	Test condition
Halt test	4 ~ 5	$T_{a,min} - 10^{\circ}\text{C}$ to $T_{a,max} + 10^{\circ}\text{C}$ , $5^{\circ}\text{C}$ step, $V_{in}$ = min to max, 0 ~ 105% load
Vibration	3	Frequency range: 5Hz ~ 20Hz, 20Hz ~ 200Hz, A.S.D: $1.0\text{m}^2/\text{s}^3$ , -3db/oct, axes of vibration: X/Y/Z Time: 30min/axes
Mechanical shock	3	30g, 6ms, 3 axes, 6 directions, 3 times/direction
Thermal shock	3	$-40^{\circ}\text{C}$ to $+100^{\circ}\text{C}$ , unit temperature 20 cycles
Thermal cycling	3	$-40^{\circ}\text{C}$ to $+85^{\circ}\text{C}$ , temperature change rate: $1^{\circ}\text{C}/\text{min}$ , cycles: 2 cycles
Humidity	3	$40^{\circ}\text{C}$ , 95%RH, 48h
Solder ability	15	IPC J-STD-002C-2007

## Characteristic Curves

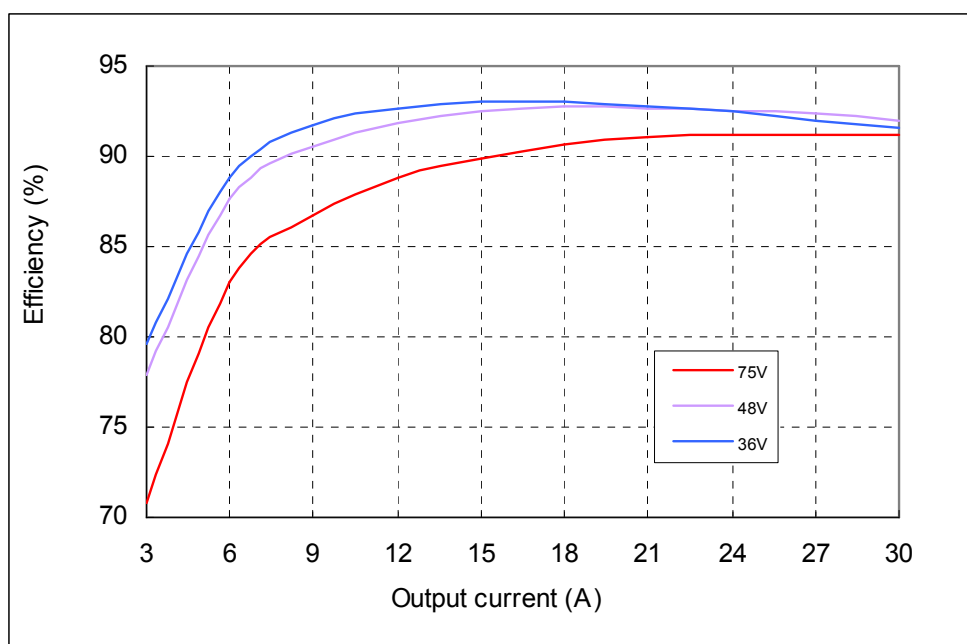

Figure 1 Efficiency vs. output current,  $T_a=25^{\circ}\text{C}$ ,  $V_o=3.3\text{V}$

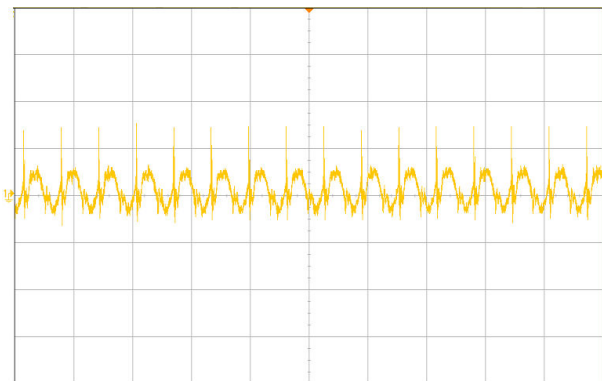

Figure 2 Output ripple & noise (5µs/div, 20mV/div), see Figure 16 for test configuration

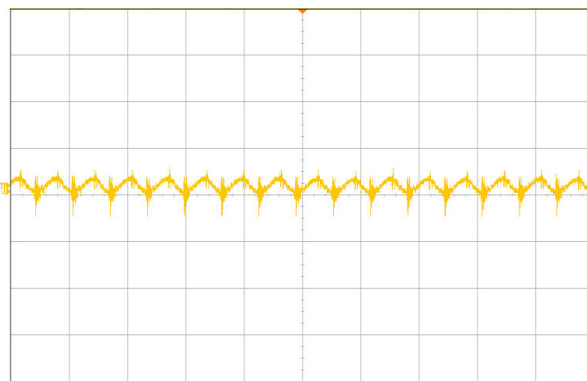

Figure 3 Input reflected ripple current (5µs/div, 5mA/div), see Figure 16 for test configuration

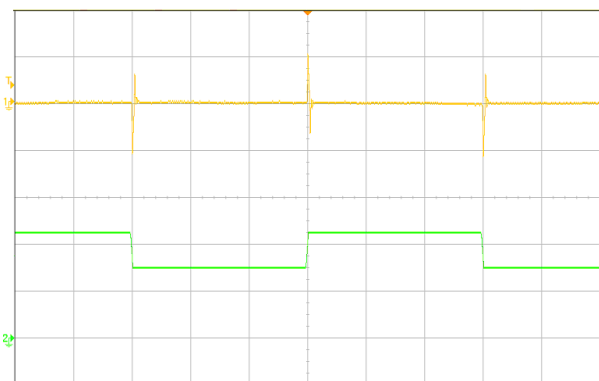

Figure 4 Dynamic response for 25% load step (50% ~ 75% ~ 50%) and 0.1A/µs slew rate, (2ms/div), see Figure 11 for test configuration; CH1-output voltage (50mV/div); CH2-output current (10A/div)

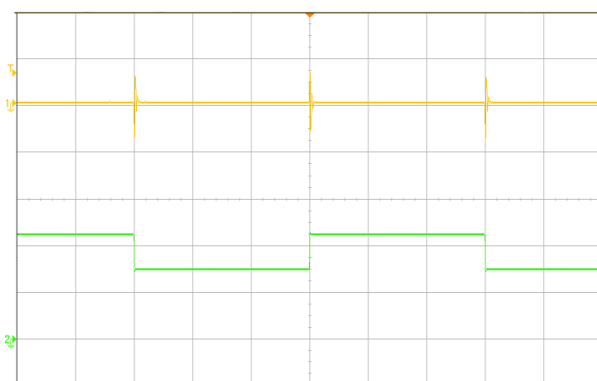

Figure 5 Dynamic response for 25% load step (50% ~ 75% ~ 50%) and 1A/µs slew rate, (2ms/div), see Figure 11 for test configuration; CH1-output voltage (200mV/div); CH2-output current (10A/div)

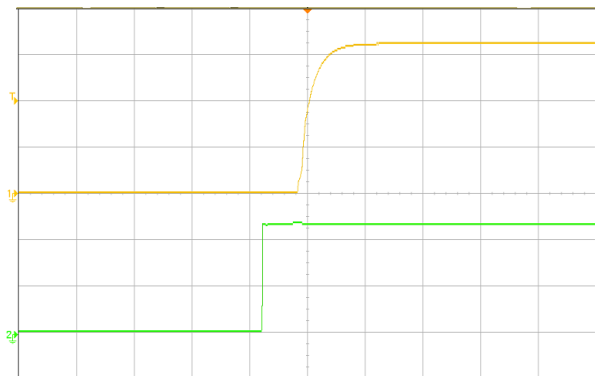

Figure 6 Output voltage startup by power on, (5ms/div), see Figure 11 for test configuration; CH1-output voltage (1V/div); CH2-input voltage (20V/div)

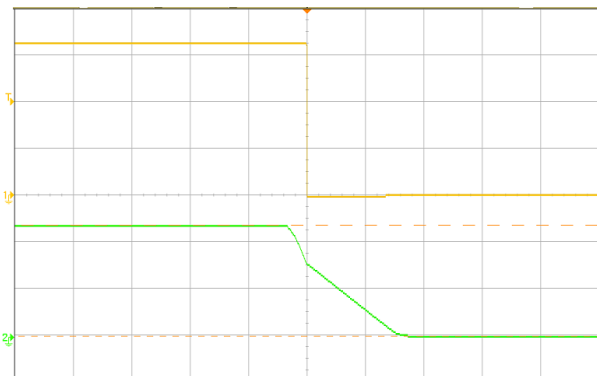

Figure 7 Output voltage shut down by power off, (50ms/div), see Figure 11 for test configuration; CH1-output voltage (1V/div); CH2-input voltage (20V/div)

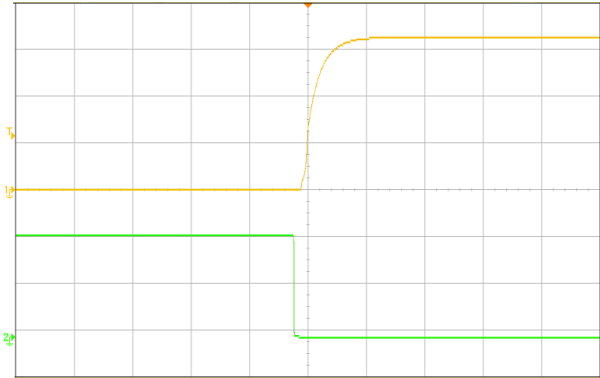

Figure 8 Output voltage startup by remote ON, (5ms/div), see Figure 11 for test configuration; CH1-output voltage (1V/div); CH2-remote ON voltage (2V/div)

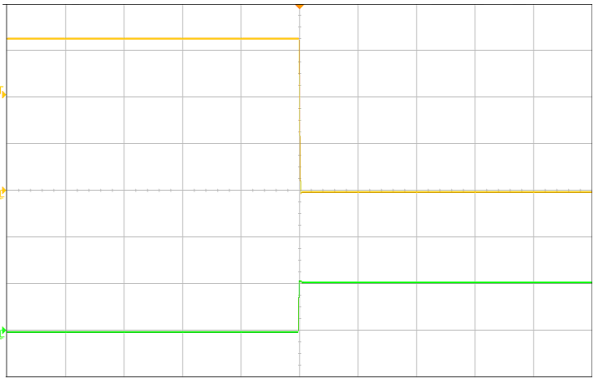

Figure 9 Output voltage shutdown by remote OFF, (1ms/div), see Figure 11 for test configuration; CH1-output voltage (1V/div); CH2-remote OFF voltage (5V/div)



Figure 10 OTP test point



# Application Note

## Typical Application

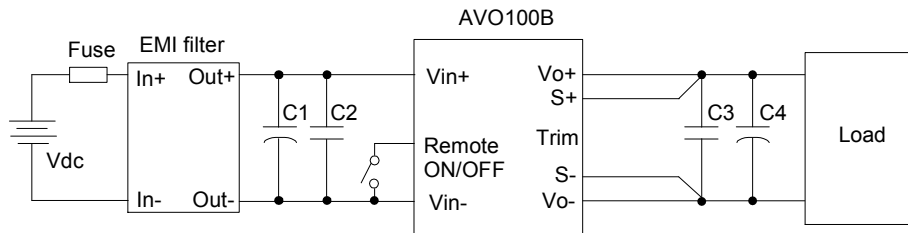

Figure 11 Typical application

C1: 100 $\mu$ F/100V electrolytic capacitor, P/N: UPM2A101MPD (Nichicon) or equivalent caps

C2, C3: 1 $\mu$ F/100V X7R ceramic capacitor, P/N: C3225X7R2A105KT0L0U (TDK) or equivalent caps

C4: 220 $\mu$ F/25V electrolytic capacitor, P/N: UPM1E221MED (Nichicon) or equivalent caps

Note: If ambient temperature is below -5°C, additional 220 $\mu$ F tantalum capacitor (Low ESR, ESR $\leq$ 100m $\Omega$ ) is needed for output.

Fuse: External fast blow fuse with a rating of 6.3A/250Vac. The recommended fuse model is GDA-V-6.3A from Cooper Bussmann Inc.

## Remote ON/OFF

Either positive or negative remote ON/OFF logic is available in AVO100B-48S3V3. The logic is CMOS and TTL compatible.

Below is the detailed internal circuit and reference in AVO100B-48S3V3.

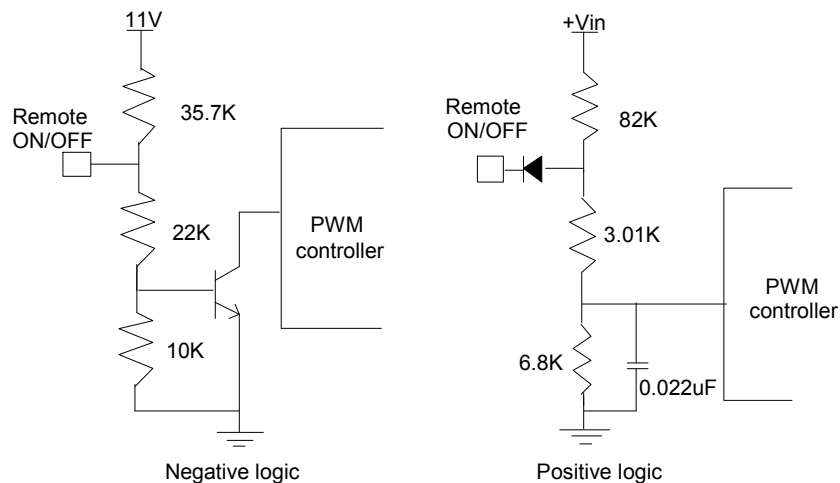

Figure 12 Remote ON/OFF internal diagram

The voltage between pin Remote ON/OFF and pin Vin- must not exceed the range listed in table 'Feature characteristics' to ensure proper operation. The external remote ON/OFF circuit is highly recommended as shown in Figure 13.

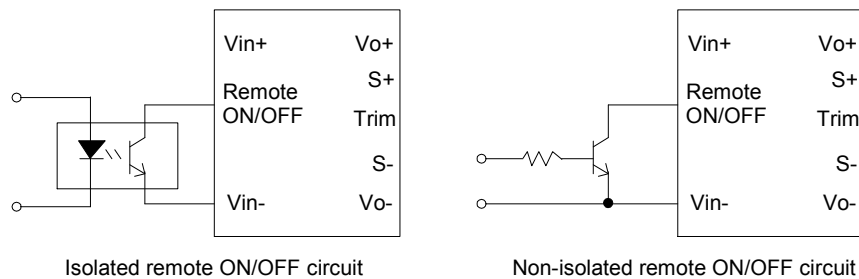

Figure 13 External remote ON/OFF circuit

### Trim Characteristics

Connecting an external resistor between Trim pin and V<sub>o-</sub> pin will decrease the output voltage, while connecting it between Trim and V<sub>o+</sub> will increase the output voltage. The following equations determine the external resistance to obtain the trimmed output voltage.

$$R_{adj-down} = \frac{510}{\Delta} - 10.2(k\Omega)$$

$$R_{adj-up} = \frac{5.1 \times V_{nom} \times (100 + \Delta)}{1.225 \times \Delta} - \frac{510}{\Delta} - 10.2(k\Omega)$$

$\Delta$ : Output e rate against nominal output voltage.

$$\Delta = \frac{100 \times (V_{nom} - V_0)}{V_{nom}}$$

$V_{nom}$ : Nominal output voltage.

For example, to get 3.63V output, the trimming resistor is

$$\Delta = \frac{100 \times (V_{nom} - V_0)}{V_{nom}} = \frac{100 \times (3.63 - 3.3)}{3.3} = 10$$

$$R_{adj-up} = \frac{5.1 \times 3.3 \times (100 + 10)}{1.225 \times 10} - \frac{510}{10} - 10.2 = 89.9(k\Omega)$$

The output voltage can also be trimmed by potential applied at the Trim pin.

$$V_O = (V_{trim} + 1.225) \times 1.347$$

Where  $V_{trim}$  is the potential that applied at the Trim pin, and  $V_o$  is the desired output voltage. When trimming up, the output current should be decreased accordingly so as not to exceed the maximum output power.

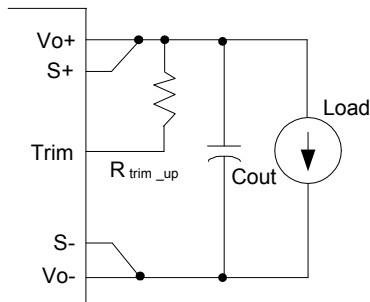

Figure 14 Trim up

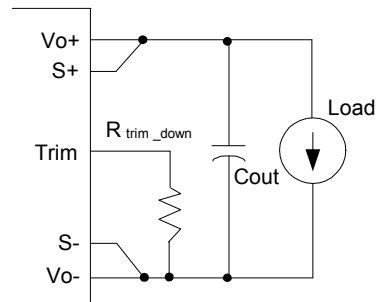

Figure 15 Trim down

### Sense Characteristics

If the load is far from the unit, connect S+ and S- to the terminal of the load respectively to compensate the voltage drop on the transmission line. See Figure 11.

If the sense compensate function is not necessary, connect S+ to Vo+ and S- to Vo- directly.

### Input Ripple & Inrush Current And Output Ripple & Noise Test Configuration

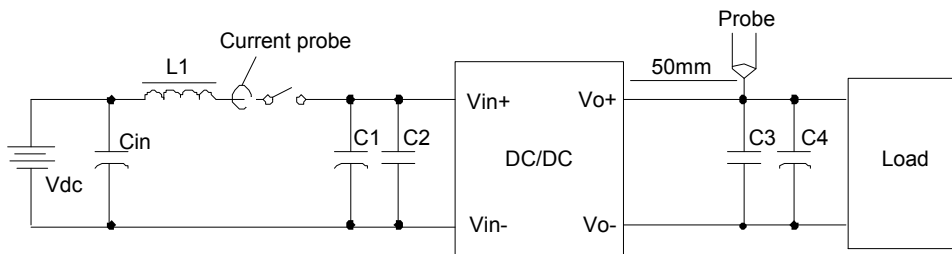

Figure 16 Input ripple & inrush current, ripple & noise test configuration

Vdc: DC power supply

L1: 12μH

Cin: 220μF/100V typical

C1 ~ C4: See Figure 11

Note: It is recommended to use a coaxial cable with series 50Ω resistor and 0.68μF ceramic capacitor or a ground ring of probe to test output ripple & noise.

### EMC Test Conditions

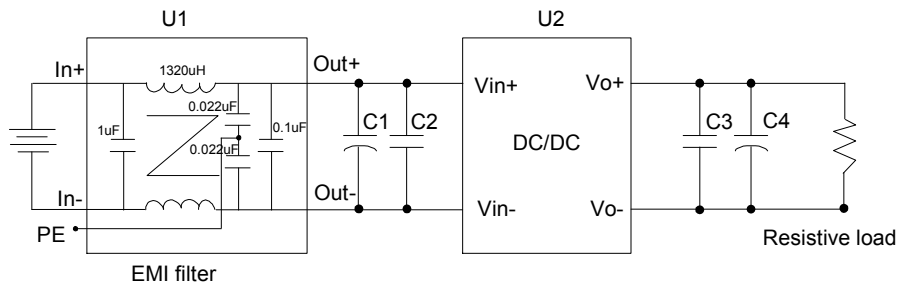

Figure 17 EMC test configuration

- U1: Input EMC filter
- U2: Module to test, AVO100B-48S3V3
- C1 ~ C4: See Figure 11

### Thermal Considerations

The converter is designed to operate in different thermal environments and sufficient cooling must be provided. Proper cooling can be verified by measuring the temperature at the test points as shown in Figure 18. The temperatures at these points should not exceed the maximum values in Table 1.

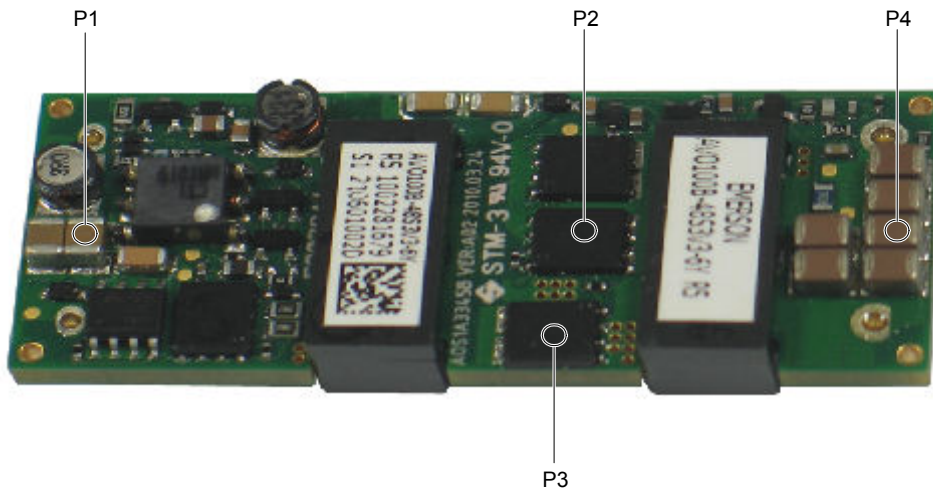

Figure 18 Temperature test points

Table 1 Temperature limit of the test points

Test point	Temperature limit
P1	118°C
P2	130°C
P3	130°C
P4	118°C

For a typical application, Figure 19 shows the derating of output current vs. ambient air temperature at different air velocity. Figure 20 shows the thermal image taken by a RF camera at a rated I/O condition.

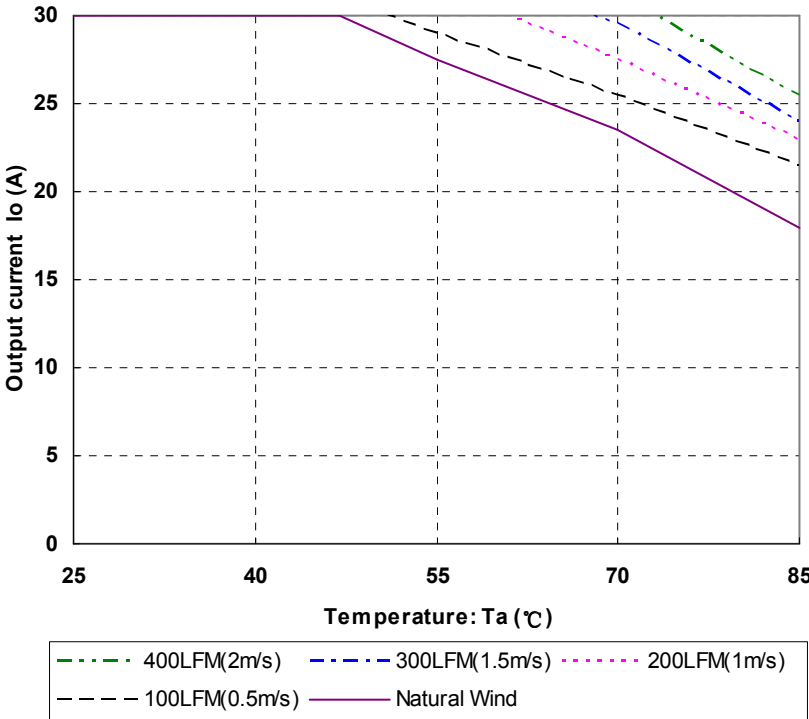

Figure 19 Output power derating, 48V<sub>in</sub>, air flowing across the converter from pin 3 to pin 1

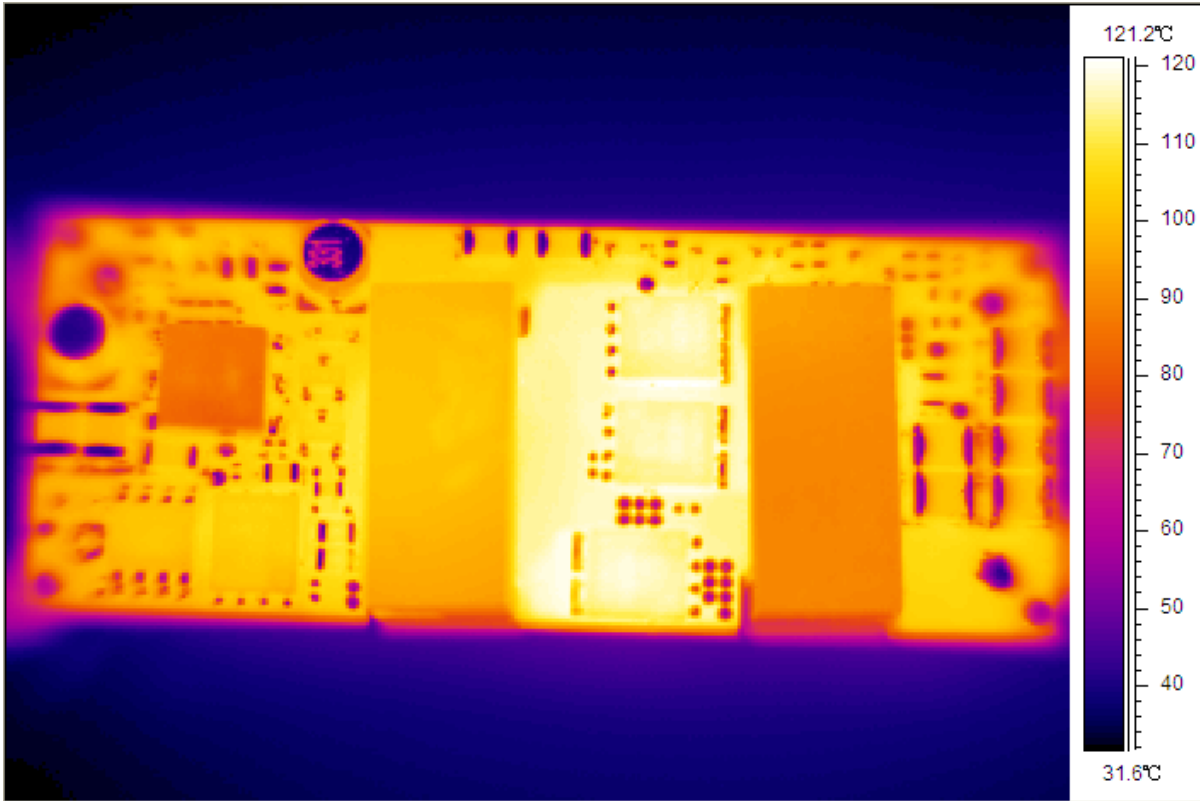
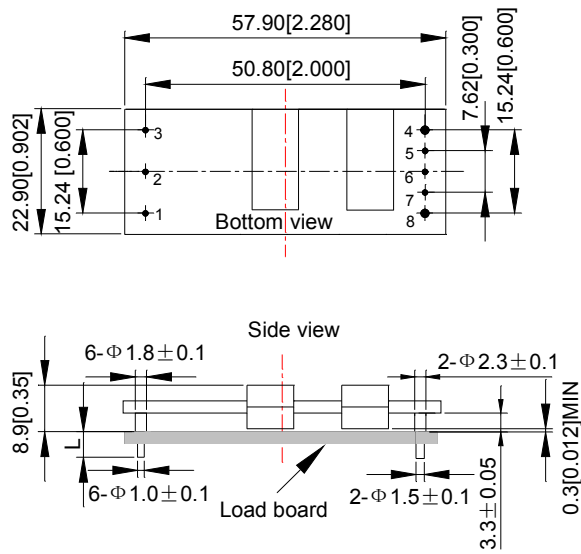

Figure 20 Thermal image, 48V<sub>in</sub>, 3.3V<sub>o</sub>, full load, room temperature, 100LFM (air flowing from pin 3 to pin 1)

Mechanical Diagram



Unit: mm[inch] Bottom view: pin on upside

Tolerance: X.Xmm ± 0.4mm [X.X in. ± 0.02in.]

X.XXmm ± 0.25mm [X.XX in. ± 0.01in.]

Figure 21 Mechanical diagram

Pin Length Option

Device code suffix	L
-4	4.8mm ± 0.25mm
-6	3.8mm ± 0.25mm
-8	2.8mm ± 0.25mm
None	5.8mm ± 0.25mm

Pin Designations

Pin No.	Name	Function
1	V <sub>in+</sub>	Positive input voltage
2	Remote ON/OFF	Remote control
3	V <sub>in-</sub>	Negative input voltage
4	V <sub>o-</sub>	Negative output voltage
5	S-	Negative remote sense
6	Trim	Output voltage trim
7	S+	Positive remote sense
8	V <sub>o+</sub>	Positive output voltage

## Soldering

The product is intended for standard manual or wave soldering.

When wave soldering is used, the temperature on pins is specified to maximum 255°C for maximum 7s.

When soldering by hand, the iron temperature should be maintained at 300°C ~ 380°C and applied to the converter pins for less than 10s. Longer exposure can cause internal damage to the converter.

Cleaning of solder joint can be performed with cleaning solvent IPA or simulative.

## Ordering Information

<b>AVO100B</b>	<b>-</b>	<b>48</b>	<b>S</b>	<b>3V3</b>	<b>P</b>	<b>B</b>	<b>-</b>	<b>6</b>	<b>Y</b>
①		②	③	④	⑤	⑥		⑦	⑧

①	Model series	AVO: high efficiency eighth brick series, 100: output power 100W
②	Input voltage	48: 36V ~ 75V input range, rated input voltage 48V
③	Output number	S: single output
④	Rated output voltage	3V3: 3.3V output
⑤	Remote ON/OFF logic	Default: negative logic; P: positive logic
⑥	Baseplate status	B: with baseplate; default: open frame
⑦	Pin length	-6: 3.8mm
⑧	RoHS status	Y: RoHS, R5; L: RoHS, R6

Model number	Description
AVO100B-48S3V3-6Y	3.8mm pin length; negative on/off logic; open frame; R5 compliant
AVO100B-48S3V3P-6Y	3.8mm pin length; positive on/off logic; open frame; R5 compliant
AVO100B-48S3V3B-6Y	3.8mm pin length; negative on/off logic; baseplated; R5 compliant; for detailed information, refer to <i>AVO100B-48S3V3B Technical Reference Notes</i>
AVO100B-48S3V3PB-6Y	3.8mm pin length; negative on/off logic; baseplated; R5 compliant; for detailed information, refer to <i>AVO100B-48S3V3B Technical Reference Notes</i>

## Hazardous Substances Announcement (RoHS Of China)

Parts	Hardarzous substances					
	Pb	Hg	Cd	Cr <sup>6+</sup>	PBB	PBDE
AVO100B-48S3 V3XX-6Y	√	x	x	x	x	x
<p>x: Means the content of the hazardous substances in all the average quality materials of the part is within the limits specified in SJ/T-11363-2006</p> <p>√: Means the content of the hazardous substances in at least one of the average quality materials of the part is outside the limits specified in SJ/T11363-2006</p>						
<p>Emerson Network Power Co., Ltd. has been committed to the design and manufacturing of environment-friendly products. It will reduce and eventually eliminate the hazardous substances in the products through unremitting efforts in research. However, limited by the current technical level, the following parts still contain hazardous substances due to the lack of reliable substitute or mature solution:</p> <ol style="list-style-type: none"> <li>1. Solders (including high-temperature solder in parts) contain plumbum.</li> <li>2. Glass of electric parts contains plumbum.</li> <li>3. Copper alloy of pins contains plumbum</li> </ol>						



Компания «Океан Электроники» предлагает заключение долгосрочных отношений при поставках импортных электронных компонентов на взаимовыгодных условиях!

Наши преимущества:

- Поставка оригинальных импортных электронных компонентов напрямую с производств Америки, Европы и Азии, а так же с крупнейших складов мира;
- Широкая линейка поставок активных и пассивных импортных электронных компонентов (более 30 млн. наименований);
- Поставка сложных, дефицитных, либо снятых с производства позиций;
- Оперативные сроки поставки под заказ (от 5 рабочих дней);
- Экспресс доставка в любую точку России;
- Помощь Конструкторского Отдела и консультации квалифицированных инженеров;
- Техническая поддержка проекта, помощь в подборе аналогов, поставка прототипов;
- Поставка электронных компонентов под контролем ВП;
- Система менеджмента качества сертифицирована по Международному стандарту ISO 9001;
- При необходимости вся продукция военного и аэрокосмического назначения проходит испытания и сертификацию в лаборатории (по согласованию с заказчиком);
- Поставка специализированных компонентов военного и аэрокосмического уровня качества (Xilinx, Altera, Analog Devices, Intersil, Interpoint, Microsemi, Actel, Aeroflex, Peregrine, VPT, Syfer, Eurofarad, Texas Instruments, MS Kennedy, Miteq, Cobham, E2V, MA-COM, Hittite, Mini-Circuits, General Dynamics и др.);

Компания «Океан Электроники» является официальным дистрибьютором и эксклюзивным представителем в России одного из крупнейших производителей разъемов военного и аэрокосмического назначения «JONHON», а так же официальным дистрибьютором и эксклюзивным представителем в России производителя высокотехнологичных и надежных решений для передачи СВЧ сигналов «FORSTAR».



## JONHON

«JONHON» (основан в 1970 г.)

Разъемы специального, военного и аэрокосмического назначения:

(Применяются в военной, авиационной, аэрокосмической, морской, железнодорожной, горно- и нефтедобывающей отраслях промышленности)

«FORSTAR» (основан в 1998 г.)

ВЧ соединители, коаксиальные кабели,  
кабельные сборки и микроволновые компоненты:

(Применяются в телекоммуникациях гражданского и специального назначения, в средствах связи, РЛС, а так же военной, авиационной и аэрокосмической отраслях промышленности).



Телефон: 8 (812) 309-75-97 (многоканальный)

Факс: 8 (812) 320-03-32

Электронная почта: [ocean@oceanchips.ru](mailto:ocean@oceanchips.ru)

Web: <http://oceanchips.ru/>

Адрес: 198099, г. Санкт-Петербург, ул. Калинина, д. 2, корп. 4, лит. А