

# EMI9404

## PRAETORIAN® III 4-Channel EMI Array with ESD Protection

### Description

The EMI9404 is an inductor-based (L-C) EMI filter array with ESD protection, which integrates four filters in a UDFN package with 0.40 mm pitch. Each EMI filter channel of the EMI9404 is implemented with the component value of 1.8 pF–35 nH–4.7 pF–35 nH– 6 pF. The cut-off frequency at –3 dB attenuation is 300 MHz and can be used in applications where the data rates are as high as 160 Mbps, while providing greater than –35 dB attenuation over the 800 MHz to 2.7 GHz frequency range. The parts include ESD diodes on every I/O pin and provide a high level of protection against electrostatic discharge (ESD). The ESD protection diodes connected to the external filter ports are designed and characterized to safely dissipate ESD strikes of ±14 kV, which is beyond the maximum requirement of the IEC61000–4–2 international standard.

This device is particularly well suited for wireless handsets, mobile LCD modules and PDAs because of its small package format and easy-to-use pin assignments. In particular, the EMI9404 is ideal for EMI filtering and protecting data and control lines for the LCD display and camera interface in mobile handsets.

The EMI9404 is housed in space saving, low profile, 0.40 mm pitch UDFN packages in a RoHS compliant, Pb-Free format.

### Features

- Four Channels of EMI Filtering with Integrated ESD Protection
- ±14 kV ESD Protection (IEC 61000–4–2, contact discharge) at External Pin
- Greater than –40 dB Attenuation (typical) at 1 GHz
- UDFN Pb-Free Package with 0.40 mm Lead Pitch:  
4-ch. = 8-lead UDFN
- UDFN Package Size: 8-lead: 1.70 mm x 1.35 mm
- Increased Robustness Against Vertical Impacts During Manufacturing Process
- These Devices are Pb-Free and are RoHS Compliant

### Applications

- LCD and Camera Data Lines in Mobile Handsets
- I/O Port Protection for Mobile Handsets, Notebook Computers, PDAs etc.
- EMI Filtering for Data Ports in Cell Phones, PDAs or Notebook Computers
- Wireless Handsets
- Handheld PCs/PDAs
- LCD and Camera Modules



ON Semiconductor®

<http://onsemi.com>

### MARKING DIAGRAMS



UDFN8  
CASE 517BC

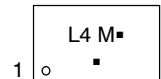

- L4 = Specific Device Code
- M = Date Code
- = Pb-Free Package

(\*Note: Microdot may be in either location)

### PINOUTS

Internal Pins  
(Lower ESD Event)

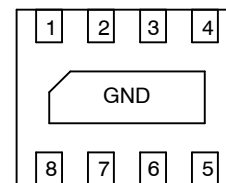

External Pins  
(Higher ESD Event)  
(Bottom View)

### ORDERING INFORMATION

See detailed ordering and shipping information in the package dimensions section on page 3 of this data sheet.

# EMI9404

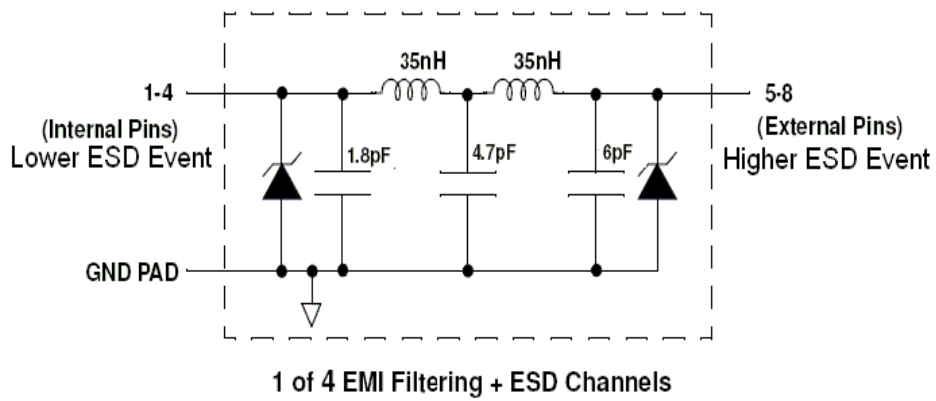

Figure 1. Electrical Schematic

Table 1. PIN DESCRIPTIONS

Pin #	Name	Description
1	FILTER1	Filter + ESD Channel 1 (Internal)
2	FILTER2	Filter + ESD Channel 2 (Internal)
3	FILTER3	Filter + ESD Channel 3 (Internal)
4	FILTER4	Filter + ESD Channel 4 (Internal)
5	FILTER4	Filter + ESD Channel 4 (External)
6	FILTER3	Filter + ESD Channel 3 (External)
7	FILTER2	Filter + ESD Channel 2 (External)
8	FILTER1	Filter + ESD Channel 1 (External)
GND PAD	GND	Device Ground

## SPECIFICATIONS

### MAXIMUM RATINGS

Parameter	Value	Unit
Storage Temperature Range	-65 to +150	°C
Current per Inductor	15	mA
DC Package Power Rating	500	mW

Stresses exceeding Maximum Ratings may damage the device. Maximum Ratings are stress ratings only. Functional operation above the Recommended Operating Conditions is not implied. Extended exposure to stresses above the Recommended Operating Conditions may affect device reliability.

### STANDARD OPERATING CONDITIONS

Parameter	Rating	Unit
Operating Temperature Range	-40 to +85	°C

# EMI9404

## ELECTRICAL OPERATING CHARACTERISTICS (Note 1)

Symbol	Parameter	Conditions	Min	Typ	Max	Unit
$L_{TOT}$	Total Channel Inductance			70		nH
$R_{TOT}$	Total Channel DC Resistance			45		$\Omega$
$C_{TOT\_0V}$	Total Channel Capacitance, 0 V bias	0 V dc; 1 MHz, 30 mV <sub>rms</sub>		17.5	24	pF
$C_{TOT\_2.5V}$	Total Channel Capacitance, 2.5 V bias	2.5 V dc; 1 MHz, 30 mV <sub>rms</sub>		11.5		pF
$V_{ST}$	Stand-off Voltage	$I = 10 \mu A$	5.5			V
$I_{LEAK}$	Diode Leakage Current	$V_{IN} = +3.3 V$		0.1	0.5	$\mu A$
$V_{SIG}$	Signal Clamp Voltage Positive Clamp Negative Clamp	$I_{LOAD} = 10 mA$ $I_{LOAD} = -10 mA$	5.6 -1.5	6.8 -0.8	9.0 -0.4	V
$V_{ESD}$	In-system ESD Withstand Voltage a) Contact discharge per IEC 61000-4-2 standard, Level 4 ( <b>External Pins</b> ) b) Contact discharge per IEC 61000-4-2 standard, Level 1 ( <b>Internal Pins</b> ) c.) Air discharge per IEC61000-4-2 standard. Level 4 ( <b>External Pins</b> )	Notes 2 and 3	$\pm 14$  $\pm 2$  $\pm 16$			kV
$V_C$	Clamping Voltage TLP (Note 4) See Figures 4 through 7	$I_{PP} = 8 A$ $I_{PP} = 16 A$ $I_{PP} = -8 A$ $I_{PP} = -16 A$		13.7 20 -4.4 -7.6		V
$f_c$	Cut-off frequency $Z_{SOURCE} = 50 \Omega$ , $Z_{LOAD} = 50 \Omega$			345		MHz

- $T_A = 25^\circ C$  unless otherwise specified.
- ESD applied to input and output pins with respect to GND, one at a time.
- Unused pins are left open.
- ANSI/ESD STM5.5.1 – Electrostatic Discharge Sensitivity Testing using Transmission Line Pulse (TLP) Model.  
TLP conditions:  $Z_0 = 50 \Omega$ ,  $t_p = 100 ns$ ,  $t_r = 4 ns$ , averaging window;  $t_1 = 30 ns$  to  $t_2 = 60 ns$ .

## PERFORMANCE INFORMATION

### TYPICAL FILTER PERFORMANCE

( $T_A = 25^\circ C$ , DC Bias = 0 V, 50  $\Omega$  Environment)

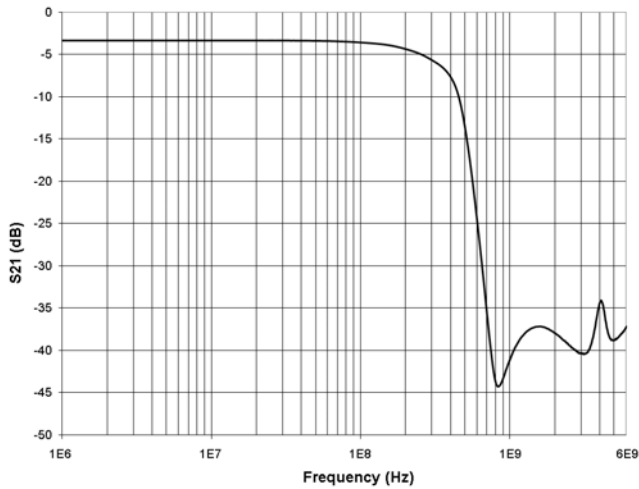

Figure 2. Typical Filter Insertion Loss

### TYPICAL DIODE CAPACITANCE VS. INPUT VOLTAGE

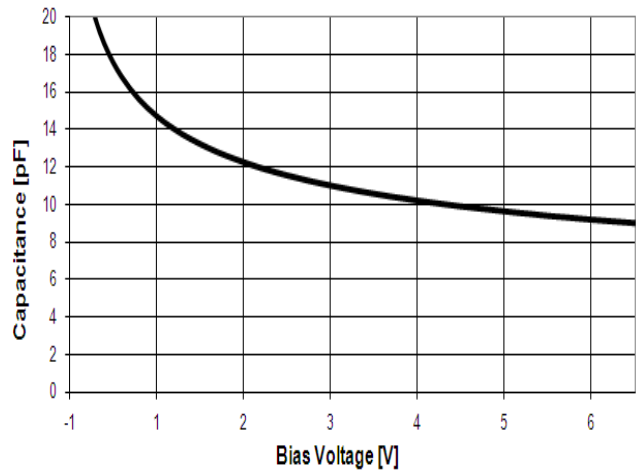

Figure 3. Filter Capacitance vs. Input Voltage (Normalized to Capacitance at 0 VDC and 25°C)

## ORDERING INFORMATION

Device	Pins	Marking	Package	Shipping†
EMI9404MUTAG	8	L4	uDFN-8 (Pb-Free)	3000 / Tape & Reel

†For information on tape and reel specifications, including part orientation and tape sizes, please refer to our Tape and Reel Packaging Specifications Brochure, BRD8011/D.

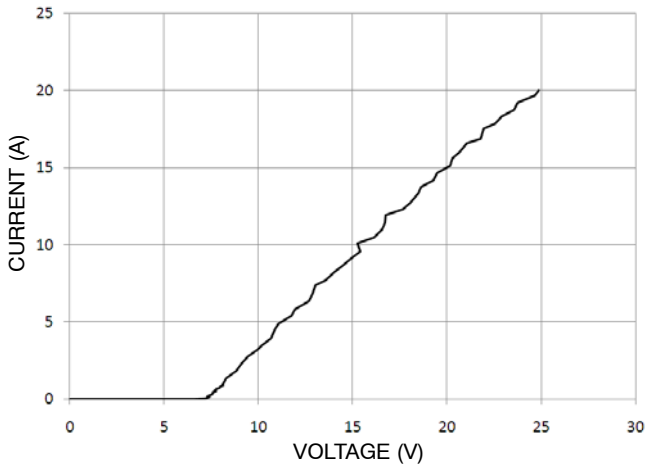

Figure 4. Positive TLP I-V Curve

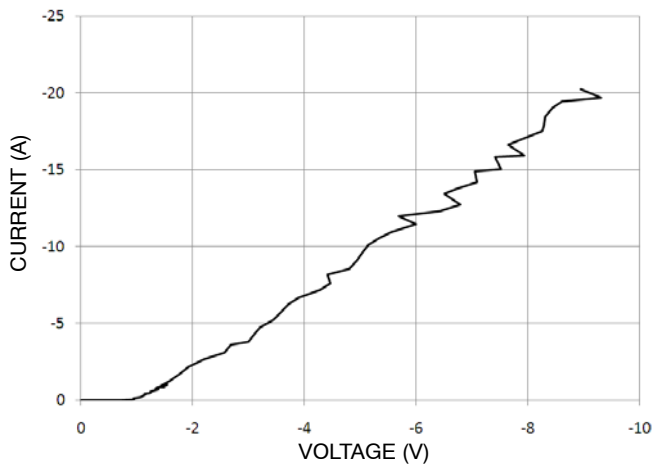

Figure 5. Negative TLP I-V Curve

**Transmission Line Pulse (TLP) Measurement**

Transmission Line Pulse (TLP) provides current versus voltage (I-V) curves in which each data point is obtained from a 100 ns long rectangular pulse from a charged transmission line. A simplified schematic of a typical TLP system is shown in Figure 6. TLP I-V curves of ESD protection devices accurately demonstrate the product’s ESD capability because the 10s of amps current levels and under 100 ns time scale match those of an ESD event. This is illustrated in Figure 7 where an 8 kV IEC 61000-4-2 current waveform into a short is compared with TLP current pulses at 8 A and 16 A, also into a short. A TLP I-V curve shows the voltage at which the device turns on, as well as how well the device clamps voltage over a range of current levels. Typical TLP I-V curves for the EMI9404 are shown in Figures 4 and 5 for positive and negative stress respectively. Application note AND9007/D gives more

detail on TLP datasheet parameters, while application note AND9006/D provides a more complete explanation of the use of TLP for understanding protection product characteristics.

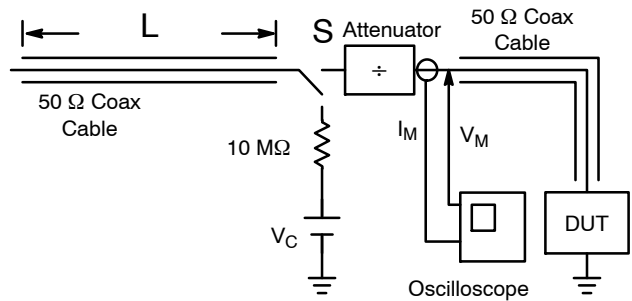

Figure 6. Simplified Schematic of a Typical TLP System

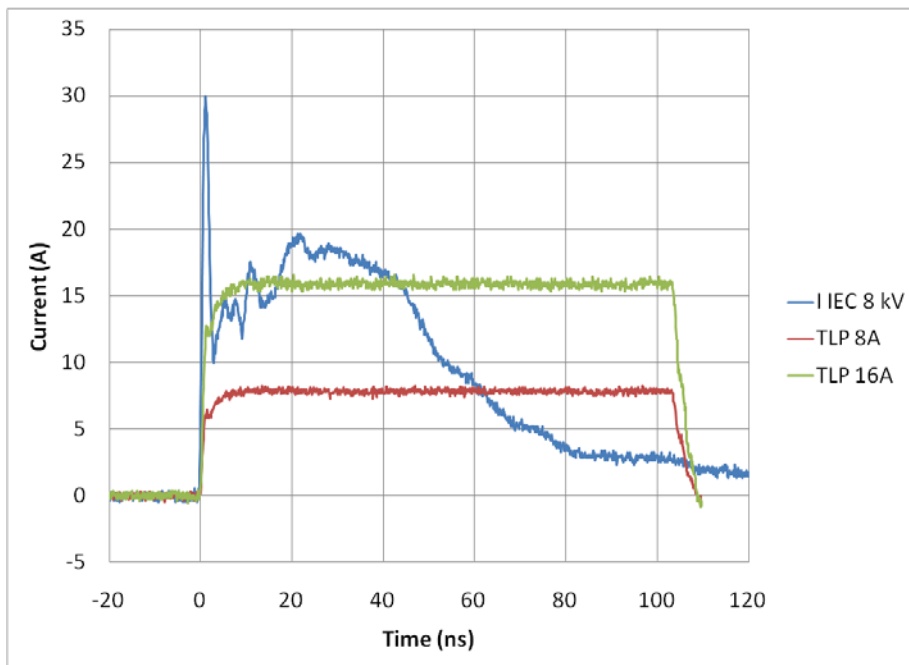
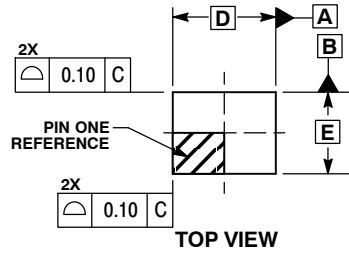

Figure 7. Comparison Between 8 kV IEC 61000-4-2 and 8 A and 16 A TLP Waveforms

# EMI9404

## PACKAGE DIMENSIONS

UDFN8, 1.7x1.35, 0.4P  
CASE 517BC  
ISSUE O



TOP VIEW

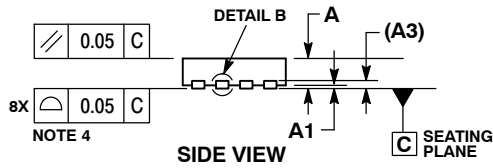

SIDE VIEW

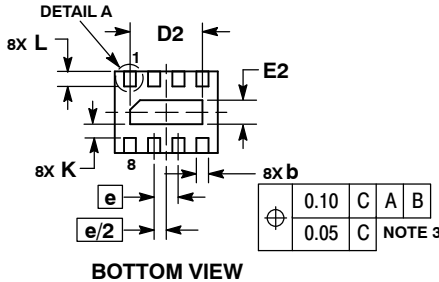

BOTTOM VIEW

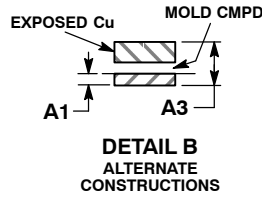

DETAIL B  
ALTERNATE  
CONSTRUCTIONS

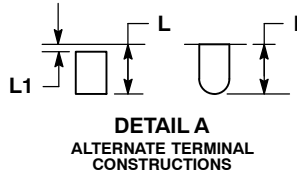

DETAIL A  
ALTERNATE TERMINAL  
CONSTRUCTIONS

NOTES:

1. DIMENSIONING AND TOLERANCING PER ASME Y14.5M, 1994.
2. CONTROLLING DIMENSION: MILLIMETERS.
3. DIMENSION b APPLIES TO PLATED TERMINAL AND IS MEASURED BETWEEN 0.15 AND 0.25 mm FROM THE TERMINAL TIP.
4. COPLANARITY APPLIES TO THE EXPOSED PAD AS WELL AS THE TERMINALS.

DIM	MILLIMETERS	
	MIN	MAX
A	0.45	0.55
A1	0.00	0.05
A3	0.13	REF
b	0.15	0.25
D	1.70	BSC
D2	1.10	1.30
E	1.35	BSC
E2	0.30	0.50
e	0.40	BSC
K	0.15	---
L	0.20	0.30
L1	---	0.05

### RECOMMENDED SOLDERING FOOTPRINT\*

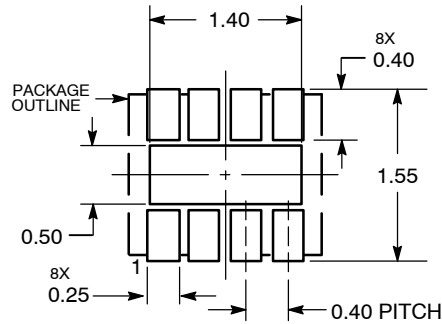

DIMENSIONS: MILLIMETERS

\*For additional information on our Pb-Free strategy and soldering details, please download the ON Semiconductor Soldering and Mounting Techniques Reference Manual, SOLDERRM/D.

PRAETORIAN is a registered trademark of Semiconductor Components Industries (SCILLC).

ON Semiconductor and  are registered trademarks of Semiconductor Components Industries, LLC (SCILLC). SCILLC reserves the right to make changes without further notice to any products herein. SCILLC makes no warranty, representation or guarantee regarding the suitability of its products for any particular purpose, nor does SCILLC assume any liability arising out of the application or use of any product or circuit, and specifically disclaims any and all liability, including without limitation special, consequential or incidental damages. "Typical" parameters which may be provided in SCILLC data sheets and/or specifications can and do vary in different applications and actual performance may vary over time. All operating parameters, including "Typicals" must be validated for each customer application by customer's technical experts. SCILLC does not convey any license under its patent rights nor the rights of others. SCILLC products are not designed, intended, or authorized for use as components in systems intended for surgical implant into the body, or other applications intended to support or sustain life, or for any other application in which the failure of the SCILLC product could create a situation where personal injury or death may occur. Should Buyer purchase or use SCILLC products for any such unintended or unauthorized application, Buyer shall indemnify and hold SCILLC and its officers, employees, subsidiaries, affiliates, and distributors harmless against all claims, costs, damages, and expenses, and reasonable attorney fees arising out of, directly or indirectly, any claim of personal injury or death associated with such unintended or unauthorized use, even if such claim alleges that SCILLC was negligent regarding the design or manufacture of the part. SCILLC is an Equal Opportunity/Affirmative Action Employer. This literature is subject to all applicable copyright laws and is not for resale in any manner.

### PUBLICATION ORDERING INFORMATION

**LITERATURE FULFILLMENT:**  
Literature Distribution Center for ON Semiconductor  
P.O. Box 5163, Denver, Colorado 80217 USA  
**Phone:** 303-675-2175 or 800-344-3860 Toll Free USA/Canada  
**Fax:** 303-675-2176 or 800-344-3867 Toll Free USA/Canada  
**Email:** orderlit@onsemi.com

**N. American Technical Support:** 800-282-9855 Toll Free  
USA/Canada  
**Europe, Middle East and Africa Technical Support:**  
Phone: 421 33 790 2910  
**Japan Customer Focus Center**  
Phone: 81-3-5817-1050

**ON Semiconductor Website:** [www.onsemi.com](http://www.onsemi.com)  
**Order Literature:** <http://www.onsemi.com/orderlit>

For additional information, please contact your local Sales Representative

Компания «Океан Электроники» предлагает заключение долгосрочных отношений при поставках импортных электронных компонентов на взаимовыгодных условиях!

Наши преимущества:

- Поставка оригинальных импортных электронных компонентов напрямую с производств Америки, Европы и Азии, а так же с крупнейших складов мира;
- Широкая линейка поставок активных и пассивных импортных электронных компонентов (более 30 млн. наименований);
- Поставка сложных, дефицитных, либо снятых с производства позиций;
- Оперативные сроки поставки под заказ (от 5 рабочих дней);
- Экспресс доставка в любую точку России;
- Помощь Конструкторского Отдела и консультации квалифицированных инженеров;
- Техническая поддержка проекта, помощь в подборе аналогов, поставка прототипов;
- Поставка электронных компонентов под контролем ВП;
- Система менеджмента качества сертифицирована по Международному стандарту ISO 9001;
- При необходимости вся продукция военного и аэрокосмического назначения проходит испытания и сертификацию в лаборатории (по согласованию с заказчиком);
- Поставка специализированных компонентов военного и аэрокосмического уровня качества (Xilinx, Altera, Analog Devices, Intersil, Interpoint, Microsemi, Actel, Aeroflex, Peregrine, VPT, Syfer, Eurofarad, Texas Instruments, MS Kennedy, Miteq, Cobham, E2V, MA-COM, Hittite, Mini-Circuits, General Dynamics и др.);

Компания «Океан Электроники» является официальным дистрибьютором и эксклюзивным представителем в России одного из крупнейших производителей разъемов военного и аэрокосмического назначения «JONHON», а так же официальным дистрибьютором и эксклюзивным представителем в России производителя высокотехнологичных и надежных решений для передачи СВЧ сигналов «FORSTAR».



## JONHON

«JONHON» (основан в 1970 г.)

Разъемы специального, военного и аэрокосмического назначения:

(Применяются в военной, авиационной, аэрокосмической, морской, железнодорожной, горно- и нефтедобывающей отраслях промышленности)

«FORSTAR» (основан в 1998 г.)

ВЧ соединители, коаксиальные кабели,  
кабельные сборки и микроволновые компоненты:

(Применяются в телекоммуникациях гражданского и специального назначения, в средствах связи, РЛС, а так же военной, авиационной и аэрокосмической отраслях промышленности).



Телефон: 8 (812) 309-75-97 (многоканальный)

Факс: 8 (812) 320-03-32

Электронная почта: [ocean@oceanchips.ru](mailto:ocean@oceanchips.ru)

Web: <http://oceanchips.ru/>

Адрес: 198099, г. Санкт-Петербург, ул. Калинина, д. 2, корп. 4, лит. А