

40V, Ultra-Low Quiescent-Current Linear Regulators in 6-Pin TDFN/8-Pin SO

General Description

The MAX15006/MAX15007 ultra-low quiescent-current linear regulators are ideal for use in automotive and battery-operated systems. These devices operate from an input voltage of 4V to 40V, deliver up to 50mA of output current, and consume only 10 μ A of quiescent current at no load. The internal p-channel pass device keeps the quiescent current low even at full load. The MAX15007 consumes only 3 μ A current when in shutdown.

The MAX15006A/MAX15007A have a fixed 3.3V output while the MAX15006B/MAX15007B have a fixed 5V output voltage. The MAX15006C/MAX15007C feature an adjustable output from 1.8V to 10V. The MAX15007 includes an enable input to turn the device on or off. All devices are short-circuit protected and include thermal shutdown.

The MAX15006/MAX15007 operate over the -40°C to +125°C automotive temperature range. These devices are available in space-saving 3mm x 3mm 6-pin TDFN and 8-pin SO thermally enhanced packages.

Applications

Automotive
 Tire-Pressure Monitoring
 Industrial
 Telecom
 Networking

Features

- ◆ Wide Operating Input Voltage Range (4V to 40V)
- ◆ Guaranteed 50mA Output Current
- ◆ Low Quiescent Current
 10 μ A (No Load) and 90 μ A (Full Load)
- ◆ Operates Through Cold-Crank Condition
- ◆ Withstands 45V Load Dump
- ◆ Low Dropout Voltage of 300mV (MAX15006B/MAX15007B)
- ◆ Stable Operation with Tiny 2.2 μ F Output Capacitor
- ◆ Enable Input (MAX15007)
- ◆ Preset 3.3V and 5.0V Output Voltages
- ◆ 1.8V to 10V Adjustable Output (MAX15006C/MAX15007C)
- ◆ Thermal and Short-Circuit Protection
- ◆ -40°C to +125°C Operating Temperature Range
- ◆ Thermally Enhanced 3mm x 3mm 6-Pin TDFN/8-Pin SO Packages

Ordering Information

PART	TEMP RANGE	PIN-PACKAGE	TOP MARK
MAX15006AASA+	-40°C to +125°C	8 SO-EP*	—
MAX15006AASA/V+	-40°C to +125°C	8 SO-EP*	—
MAX15006AATT+	-40°C to +125°C	6 TDFN-EP*	APE
MAX15006AATT/V+	-40°C to +125°C	6 TDFN-EP*	AUR

Ordering Information continued at end of data sheet.

+ Denotes a lead(Pb)-free/RoHS-compliant package.

/V denotes an automotive qualified part.

*EP = Exposed pad.

Pin Configurations

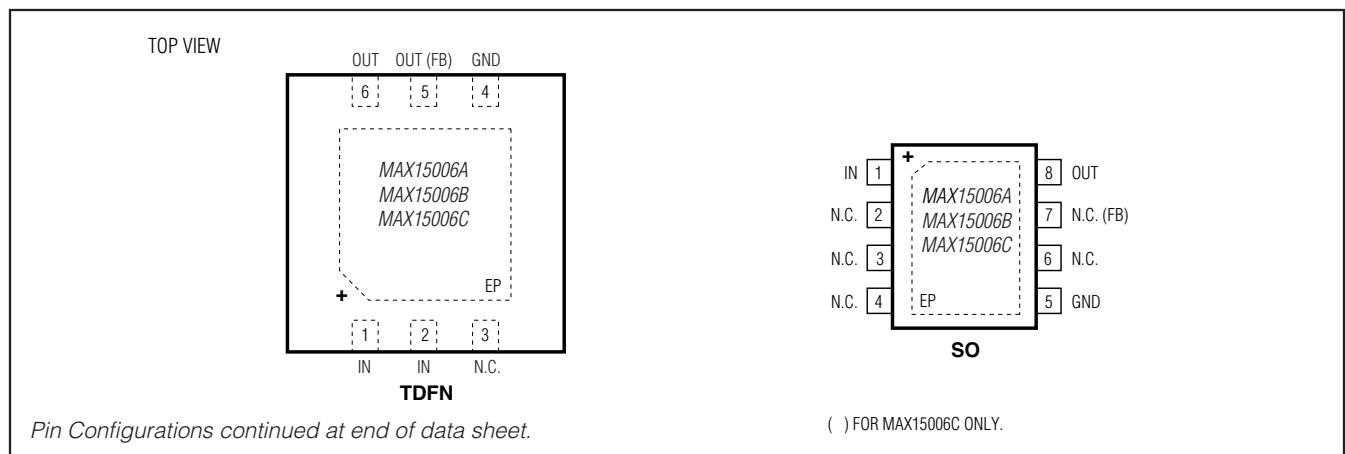

MAX15006/MAX15007

40V, Ultra-Low Quiescent-Current Linear Regulators in 6-Pin TDFN/8-Pin SO

ABSOLUTE MAXIMUM RATINGS

IN to GND-0.3V to +45V
 EN to GND-0.3V to +45V
 OUT, FB to GND-0.3V to +12V
 OUT Short-Circuit DurationContinuous
 Maximum Current Into Any Pin (except IN and OUT)±50mA
 Continuous Power Dissipation (T_A = +70°C)
 TDFN (derate 23.8mW/°C above +70°C)1904mW
 SO (derate 23.3mW/°C above +70°C)1860mW

Operating Temperature Range-40°C to +125°C
 Junction Temperature+150°C
 Storage Temperature Range-65°C to +150°C
 Lead Temperature (soldering, 10s)+300°C
 Soldering Temperature (reflow)+260°C

PACKAGE THERMAL CHARACTERISTICS (Note 1)

TDFN	Junction-to-Ambient Thermal Resistance (θ _{JA})42°C/W	SO	Junction-to-Ambient Thermal Resistance (θ _{JA})43°C/W
	Junction-to-Case Thermal Resistance (θ _{JC})8.5°C/W		Junction-to-Case Thermal Resistance (θ _{JC})7°C/W

Note 1: Package thermal resistances were obtained using the method described in JEDEC specification JESD51-7, using a four-layer board. For detailed information on package thermal considerations, refer to www.maximintegrated.com/thermal-tutorial.

Stresses beyond those listed under "Absolute Maximum Ratings" may cause permanent damage to the device. These are stress ratings only, and functional operation of the device at these or any other conditions beyond those indicated in the operational sections of the specifications is not implied. Exposure to absolute maximum rating conditions for extended periods may affect device reliability.

ELECTRICAL CHARACTERISTICS

(V_{IN} = 14V, I_{OUT} = 1mA, C_{IN} = 0.1µF, C_{OUT} = 2.2µF, T_A = T_J = -40°C to +125°C, unless otherwise noted. Typical specifications are at T_A = +25°C.) (Note 2)

PARAMETER	SYMBOL	CONDITIONS	MIN	TYP	MAX	UNITS	
Input Voltage Range	V _{IN}		4		40	V	
Ground Current	I _{GND}	Regulator on, measured at GND	I _{OUT} = 0A (MAX15006A/B/D)		10	17	µA
			I _{OUT} = 0A (MAX15006C)		8	15	
			I _{OUT} = 0A (MAX15007A/B)		11	18	
			I _{OUT} = 0A (MAX15007C)		9	16	
			I _{OUT} = 100µA (MAX15006A/B/D)		10.5	18	
			I _{OUT} = 100µA (MAX15006C)		8.5	16	
			I _{OUT} = 100µA (MAX15007A/B)		11.5	19	
			I _{OUT} = 100µA (MAX15007C)		9.5	17	
			I _{OUT} = 1mA (MAX15006A/B/D)		12	20	
			I _{OUT} = 1mA (MAX15006C)		10	18	
			I _{OUT} = 1mA (MAX15007A/B)		13	21	
			I _{OUT} = 1mA (MAX15007C)		11	19	
			I _{OUT} = 50mA (MAX15006)		90	150	
			I _{OUT} = 50mA (MAX15007)		93	150	
I _{OUT} = 60mA (MAX15006D)		110	150				
Shutdown Supply Current	I _{SHDN}	Regulator off (MAX15007 only)		3	5	µA	

MAX15006/MAX15007

40V, Ultra-Low Quiescent-Current Linear Regulators in 6-Pin TDFN/8-Pin SO

ELECTRICAL CHARACTERISTICS (continued)

($V_{IN} = 14V$, $I_{OUT} = 1mA$, $C_{IN} = 0.1\mu F$, $C_{OUT} = 2.2\mu F$, $T_A = T_J = -40^\circ C$ to $+125^\circ C$, unless otherwise noted. Typical specifications are at $T_A = +25^\circ C$.) (Note 2)

PARAMETER	SYMBOL	CONDITIONS	MIN	TYP	MAX	UNITS	
REGULATOR							
Guaranteed Output Current	I_{OUT}	$V_{IN} \geq V_{OUT} + \Delta V_{DO}$	50			mA	
		$V_{IN} \geq V_{OUT} + \Delta V_{DO}$ (MAX15006D only)	60				
Output Voltage (Note 3)	V_{OUT}	$I_{OUT} = 1mA$	MAX15006A/D, MAX15007A	3.25	3.3	3.35	V
			MAX15006B/MAX15007B	4.925	5.0	5.075	
			MAX15006C/MAX15007C	1.8		10	
Dropout Voltage (Notes 4, 5)	ΔV_{DO}	$I_{OUT} = 5mA$, MAX15006B/MAX15007B	30			53	mV
		$I_{OUT} = 5mA$, MAX15006C/MAX15007C	30			60	
		$I_{OUT} = 50mA$, MAX15006B/MAX15007B	300			525	
		$I_{OUT} = 50mA$, MAX15006C/MAX15007C	300			600	
		$I_{OUT} = 50mA$, MAX15006A/MAX15007A				1000	
		$I_{OUT} = 60mA$, MAX15006D				1000	
Line Regulation		$6V \leq V_{IN} \leq 35V$, $I_{OUT} = 1mA$				0.25	%
Load Regulation		$V_{IN} = V_{OUT} + 3V$, $I_{OUT} = 100\mu A$ to $50mA$	0.7			1.5	%
		$V_{IN} = V_{OUT} + 3V$, $I_{OUT} = 100\mu A$ to $60mA$ (MAX15006D)	0.7			1.5	
Output Current Limit			80			350	mA
Output Voltage Noise		100Hz to 100kHz, $I_{OUT} = 50mA$, $C_{OUT} = 2.2\mu F$	$V_{OUT} = 3.3V$	115			μV_{RMS}
			$V_{OUT} = 5V$	179			
Power-Supply Rejection Ratio	PSRR	$f = 100Hz$, $V_{IN_RIPPLE} = 500mV_{P-P}$, $I_{OUT} = 50mA$	66				dB
FB Threshold Voltage	V_{FB}	$I_{LOAD} = 1mA$ (MAX15006C/MAX15007C only)	1.2	1.23	1.26		V
FB Input Current	I_{FB}	$V_{FB} = 0V$, $1.5V$ (MAX15006C/MAX15007C only)	-100			+100	nA
ENABLE LOGIC							
Enable Threshold Voltage	V_{IL}					0.4	V
	V_{IH}		1.4				
Enable Threshold Hysteresis			60				mV
Enable Pulldown Current		Internally pulled down to GND	0.5				μA
Enable to Regulation Time		(Note 6)	0.4			2	ms
THERMAL SHUTDOWN							
Thermal Shutdown	T_{SHDN}	Junction temperature rising	+165				$^\circ C$
Thermal Shutdown Hysteresis	T_{HYST}		20				$^\circ C$

Note 2: Limits at $T_A = -40^\circ C$ are guaranteed by design.

Note 3: Output voltage regulation is guaranteed for $I_{OUT} \geq 5\mu A$.

Note 4: Dropout voltage is defined as $(V_{IN} - V_{OUT})$ when V_{OUT} is 2% below the value of V_{OUT} when $V_{IN} = V_{OUT} + 3V$.

Note 5: For $V_{OUT} = 3.3V$, the 700mV dropout indicates V_{OUT} does not reach 2% below V_{OUT} at $V_{IN} = V_{OUT} + 3V$ at minimum 4V input voltage.

Note 6: Enable to regulation time is the time the output takes to reach 95% of its final value with $V_{IN} = 14V$ and EN is taken from V_{IL} to V_{IH} in 5ns.

MAX15006/MAX15007

40V, Ultra-Low Quiescent-Current Linear Regulators in 6-Pin TDFN/8-Pin SO

Typical Operating Characteristics

($V_{IN} = 14V$, $C_{IN} = 0.1\mu F$, $C_{OUT} = 2.2\mu F$, $V_{EN} = V_{IN}$, $T_A = +25^\circ C$, unless otherwise noted.)

OUTPUT VOLTAGE vs. INPUT VOLTAGE (MAX15006A/MAX15007A)

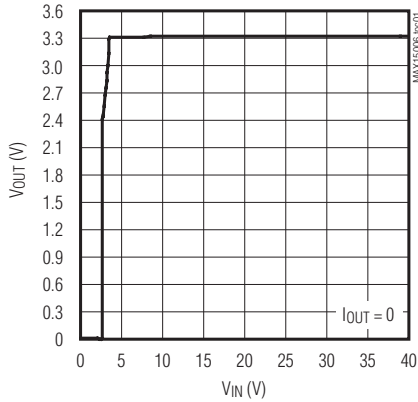

OUTPUT VOLTAGE vs. INPUT VOLTAGE (MAX15006B/MAX15007B)

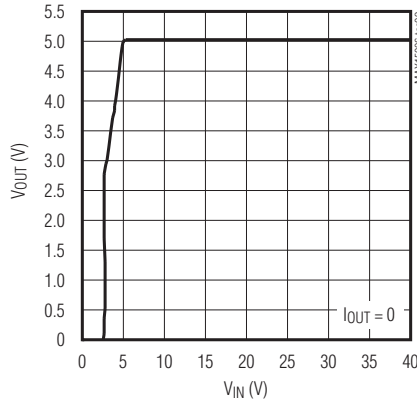

OUTPUT VOLTAGE vs. TEMPERATURE (MAX15006A/MAX15007A)

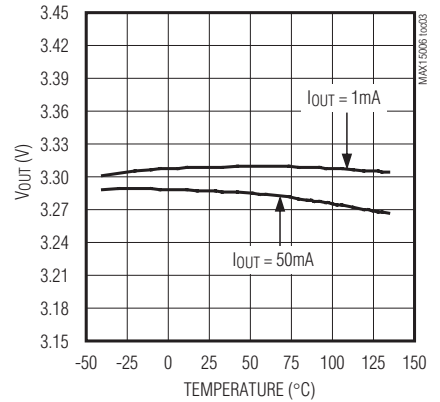

OUTPUT VOLTAGE vs. TEMPERATURE (MAX15006B/MAX15007B)

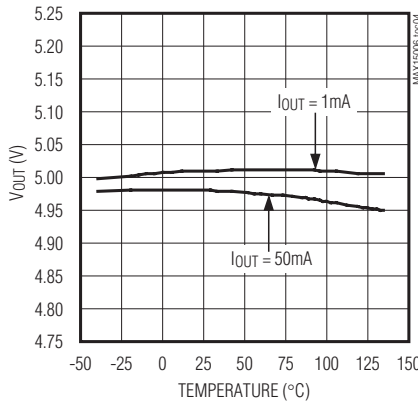

DROPOUT VOLTAGE vs. LOAD CURRENT (MAX15006B/MAX15007B)

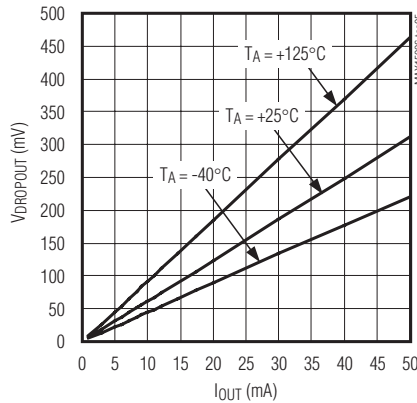

GROUND CURRENT vs. LOAD CURRENT (MAX15006B/MAX15007B)

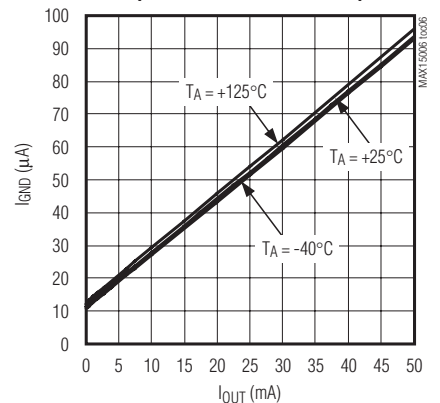

GROUND CURRENT vs. TEMPERATURE (IOUT = 0)

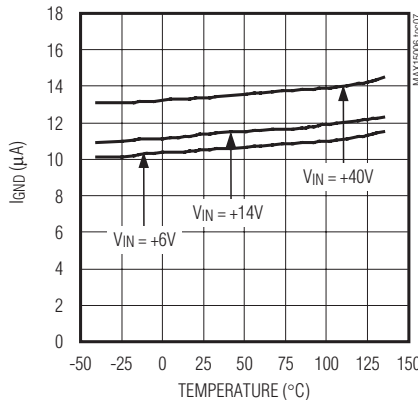

GROUND CURRENT vs. TEMPERATURE (IOUT = 50mA)

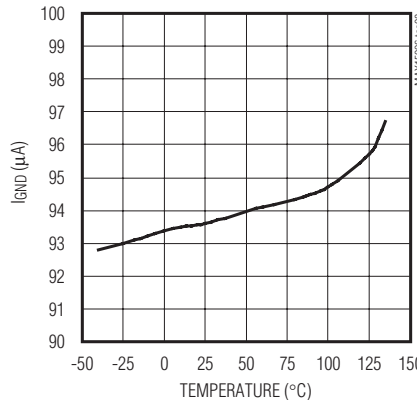

SHUTDOWN SUPPLY CURRENT vs. TEMPERATURE

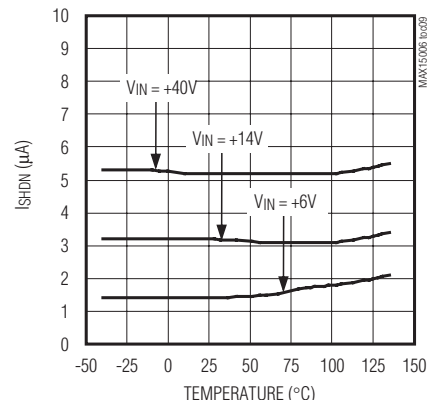

MAX15006/MAX15007

40V, Ultra-Low Quiescent-Current Linear Regulators in 6-Pin TDFN/8-Pin SO

Typical Operating Characteristics (continued)

($V_{IN} = 14V$, $C_{IN} = 0.1\mu F$, $C_{OUT} = 2.2\mu F$, $V_{EN} = V_{IN}$, $T_A = +25^\circ C$, unless otherwise noted.)

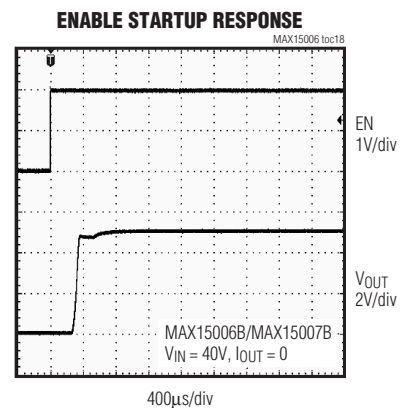
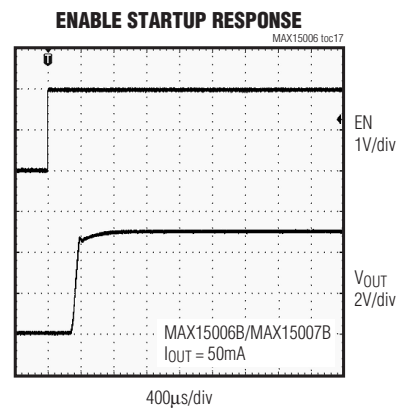
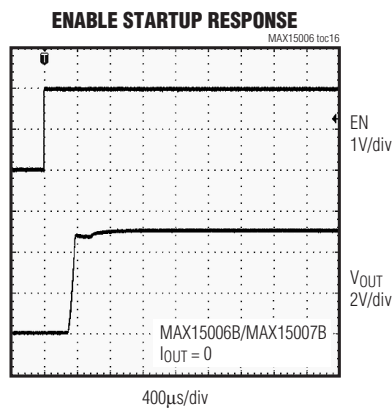
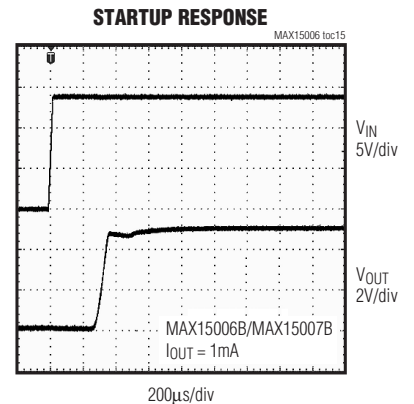
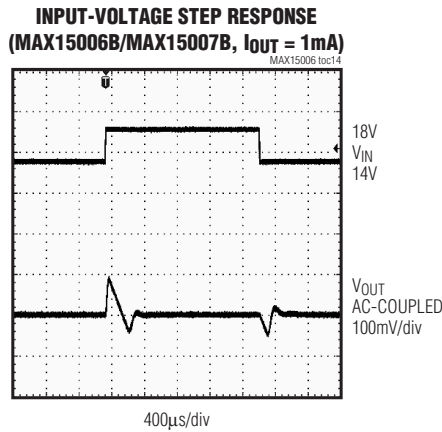
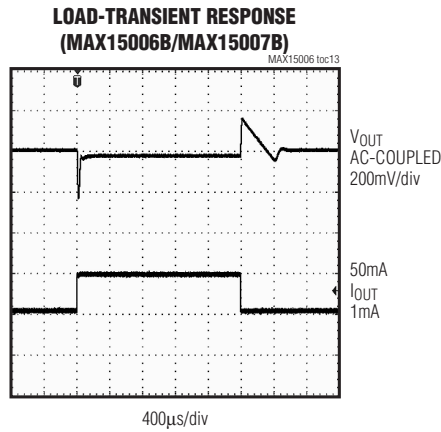
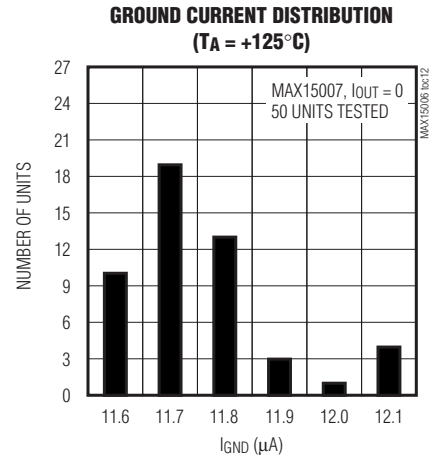
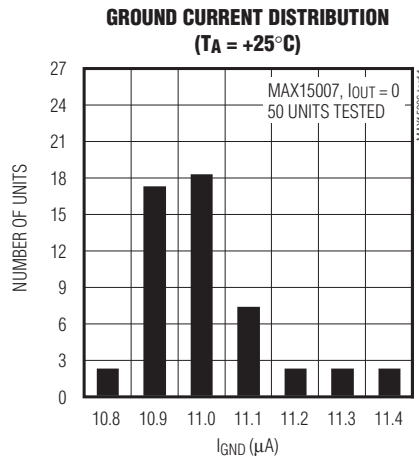
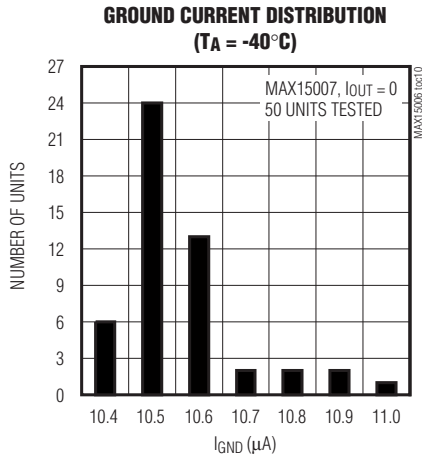

MAX15006/MAX15007

40V, Ultra-Low Quiescent-Current Linear Regulators in 6-Pin TDFN/8-Pin SO

Typical Operating Characteristics (continued)

($V_{IN} = 14V$, $C_{IN} = 0.1\mu F$, $C_{OUT} = 2.2\mu F$, $V_{EN} = V_{IN}$, $T_A = +25^\circ C$, unless otherwise noted.)

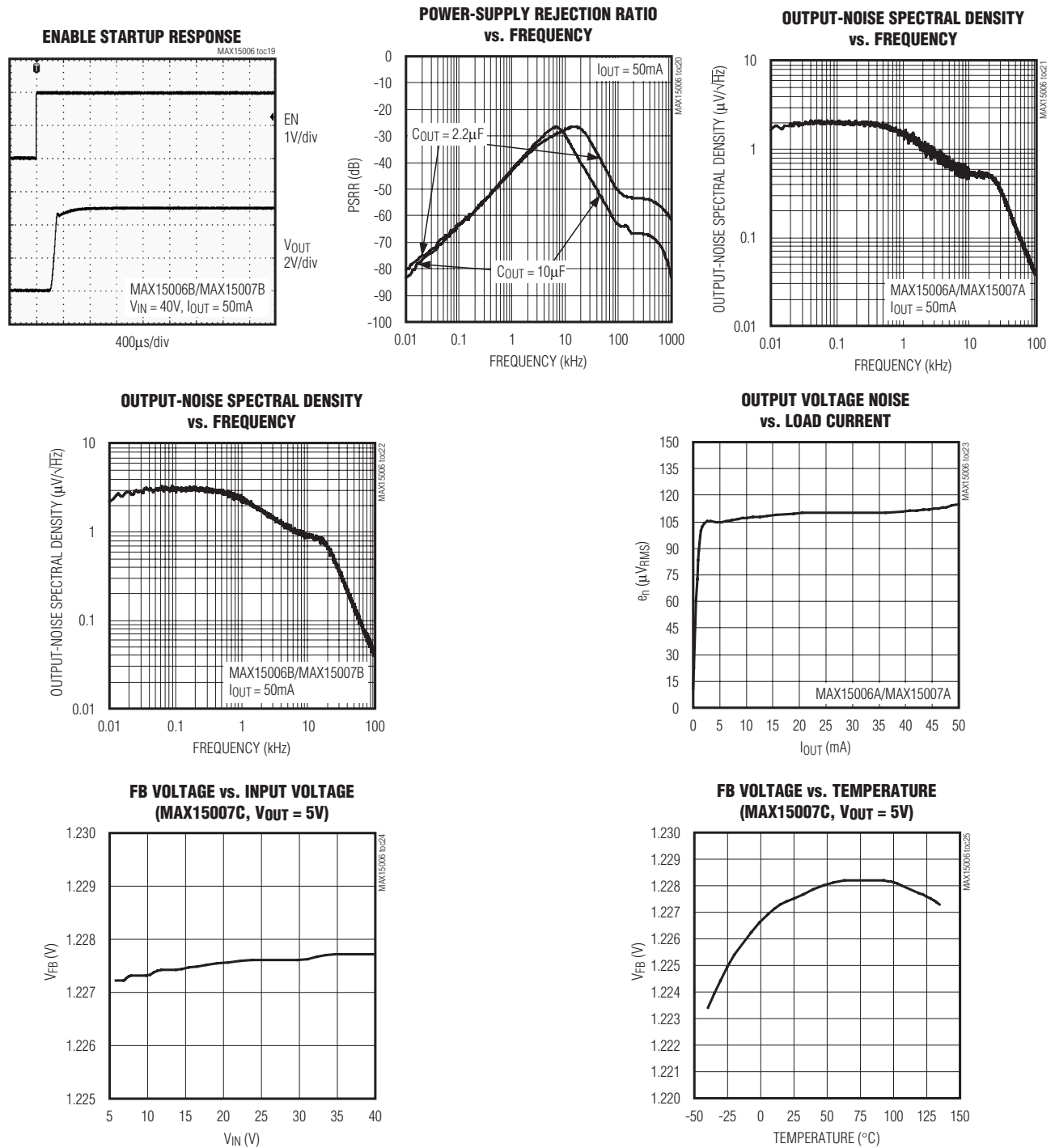

MAX15006/MAX15007

40V, Ultra-Low Quiescent-Current Linear Regulators in 6-Pin TDFN/8-Pin SO

Typical Operating Characteristics (continued)

($V_{IN} = 14V$, $C_{IN} = 0.1\mu F$, $C_{OUT} = 2.2\mu F$, $V_{EN} = V_{IN}$, $T_A = +25^\circ C$, unless otherwise noted.)

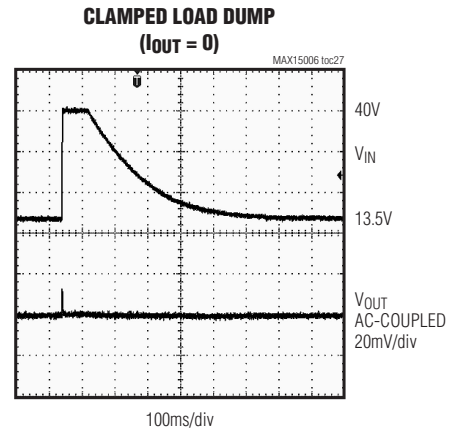
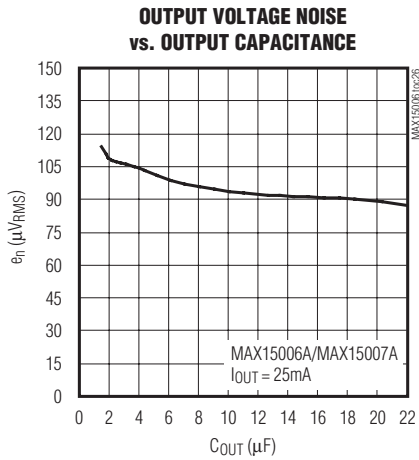

Pin Description

PIN								NAME	FUNCTION
MAX15006A/B		MAX15006C		MAX15007A/B		MAX15007C			
TDFN	SO	TDFN	SO	TDFN	SO	TDFN	SO		
1, 2	1	1, 2	1	1, 2	1	1, 2	1	IN	Regulator Supply Input. Supply voltage ranges from 4V to 40V. Bypass with a 0.1 μF capacitor to GND.
3	2, 3, 4, 6, 7	3	2, 3, 4, 6	—	2, 4, 6, 7	—	2, 4, 6	N.C.	No Connection. Not internally connected.
4	5	4	5	4	5	4	5	GND	Ground
5, 6	8	6	8	5, 6	8	6	8	OUT	Regulator Output. Bypass OUT to GND with a low-ESR capacitor with a minimum 2.2 μF .
—	—	5	7	—	—	5	7	FB	Feedback Regulation Set-Point. Connect an external resistive divider network from OUT to FB to GND to adjust the output voltage from 1.8V to 10V.
—	—	—	—	3	3	3	3	EN	Active-High Enable Input. Force EN high (or connect to V_{IN}) to turn the regulator on. Pull EN low (or leave unconnected) to place the device in a low-power shutdown mode. EN is internally pulled down to GND through a 0.5 μA sink current.
—	—	—	—	—	—	—	—	EP	Exposed Pad. Internally connected to GND. Connect EP to the ground plane for enhanced thermal performance. Do not use EP as a ground connection.

MAX15006/MAX15007

40V, Ultra-Low Quiescent-Current Linear Regulators in 6-Pin TDFN/8-Pin SO

Functional Diagrams

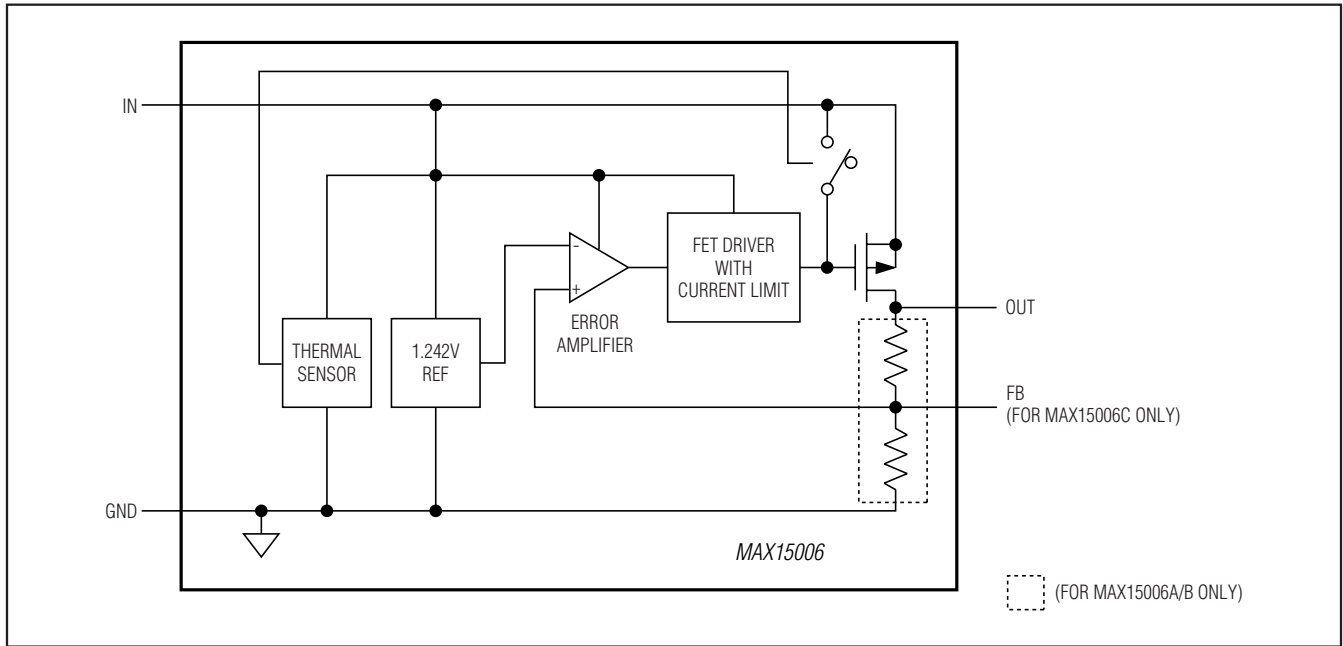

Figure 1. MAX15006 Simplified Functional Diagram

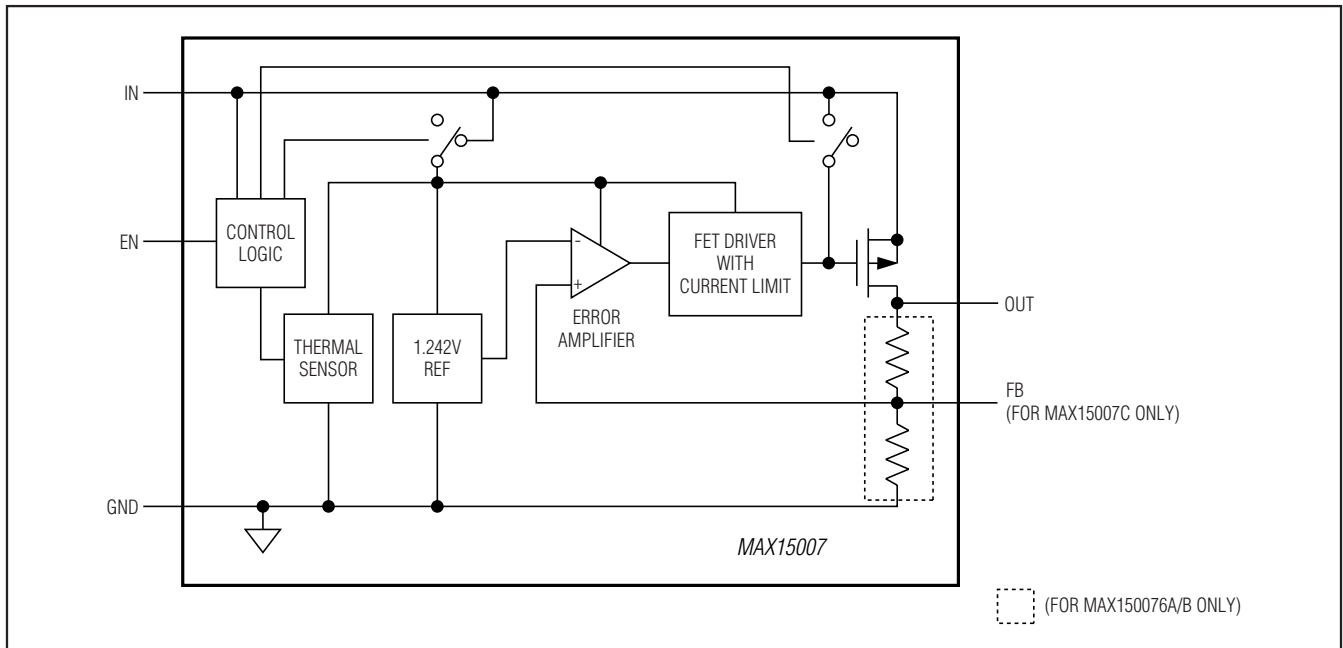

Figure 2. MAX15007 Simplified Functional Diagram

MAX15006/MAX15007

40V, Ultra-Low Quiescent-Current Linear Regulators in 6-Pin TDFN/8-Pin SO

Detailed Description

The MAX15006/MAX15007 high-voltage linear regulators operate over a 4V to 40V input voltage range. These devices guarantee 50mA load drive, and offer preset output voltages of +3.3V (MAX15006A/MAX15007A) or +5V (MAX15006B/MAX15007B) or an adjustable voltage output from 1.8V to 10V (MAX15006C/MAX15007C). Thermal shutdown and short-circuit protection prevent damage during overtemperature and overcurrent conditions. The MAX15007 includes an enable input (EN) allowing the regulators to be turned on/off using a logic-level voltage. Driving EN high turns on the device while driving EN low places the device in a low-power shutdown mode. In shutdown, the supply current is reduced to 3 μ A (typ). The MAX15006/MAX15007 operate over the -40°C to +125°C automotive temperature range. All devices are available in thermally enhanced 6-pin TDFN and 8-pin SO packages capable of dissipating 1.904W and 1.860W at $T_A = +70^\circ\text{C}$, respectively.

Regulator

The regulator accepts an input voltage from 4V to 40V. The MAX15006A/MAX15007A have a fixed 3.3V output voltage while the MAX15006B/MAX15007B offer a fixed 5V output voltage. The MAX15006C/MAX15007C feature an adjustable voltage output by connecting an external resistive divider from OUT to FB and to GND (see the *Output Voltage Setting* section).

EN Input (MAX15007 Only)

EN is an active-high, logic-level enable input that turns the device on or off. Drive EN high to turn the device on. An internal 0.5 μ A pulldown current keeps the MAX15007 in shutdown mode when driven by a three-state driver in high-impedance mode, or an open-drain driver. While in shutdown, the device consumes only 3 μ A (typ). EN withstands voltages up to 40V, allowing it to be driven by high input level voltages or connected to IN for always-on operation.

Thermal Protection

When the junction temperature exceeds +165°C, an internal thermal sensor turns the pass transistor off, and allows the device to cool. The thermal sensor turns the pass transistor on again after the junction temperature cools by 20°C. This results in a cycled output during continuous thermal-overload conditions. Thermal protection protects the MAX15006/MAX15007 in the event of fault conditions. Operation at $T_J = +150^\circ\text{C}$ without going into thermal shutdown is not guaranteed. Use Figures 3a and 3b to determine the minimum guaranteed output current.

Output Short-Circuit Current Limit

The MAX15006/MAX15007 feature a 175mA current limit. The output can be shorted to GND for an indefinite period of time without damage to the device. During a short circuit, the power dissipated across the pass transistor can quickly heat the device. When the die temperature reaches +165°C, the MAX15006/MAX15007 shut down and automatically restart after the die temperature cools by 20°C.

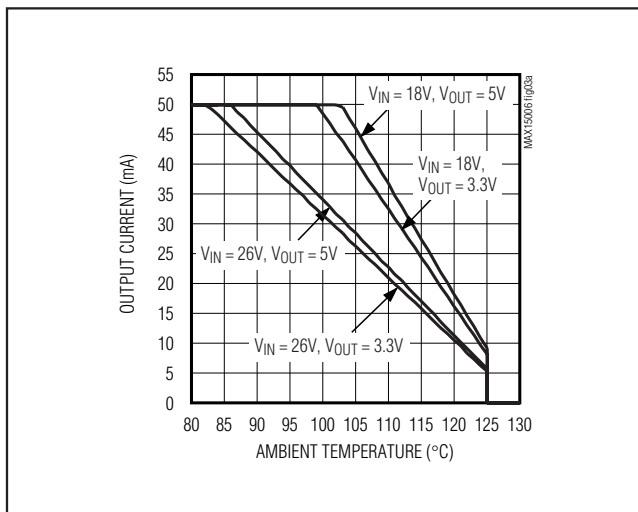

Figure 3a. Minimum Output Current vs. Ambient Temperature (6-Pin TDFN-EP)

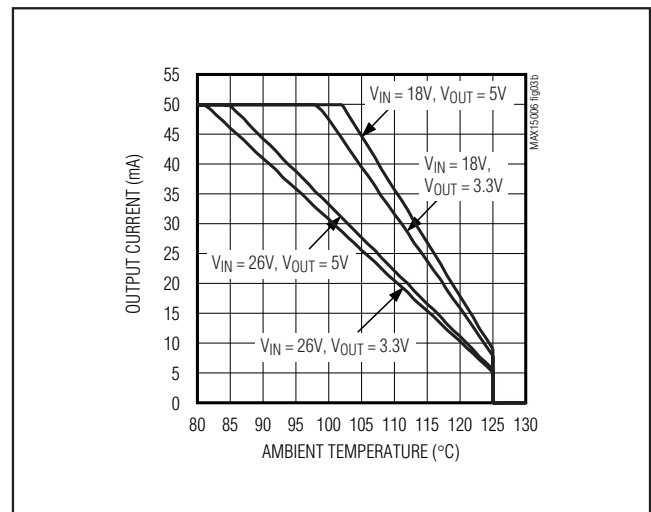

Figure 3b. Minimum Output Current vs. Ambient Temperature (8-Pin SO-EP)

MAX15006/MAX15007

40V, Ultra-Low Quiescent-Current Linear Regulators in 6-Pin TDFN/8-Pin SO

Applications Information

Output Voltage Setting

The MAX15006C/MAX15007C provide an adjustable output voltage from 1.8V to 10V and do not operate in a preset output voltage mode. Connect an external resistive divider from OUT to FB to GND as shown in Figure 4 to set the desired output voltage. V_{OUT} is calculated as follows:

$$V_{OUT} = V_{FB} \times \left(1 + \frac{R1}{R2}\right)$$

where $V_{FB} = 1.23V$ and a $5\mu A$ minimum current is required in the external divider for stability.

Available Output Current Calculation

The MAX15006/MAX15007 provide up to 50mA of continuous output current. The input voltage range extends to 40V. Package power dissipation limits the amount of output current available for a given input/output voltage and ambient temperature. Figure 5 shows the maximum allowable power dissipation for these devices to keep the junction temperature below $+150^{\circ}C$. Figure 5 assumes that the exposed metal pad of the MAX15006/MAX15007 is soldered to $1in^2$ of PCB copper.

Use Figure 5 to determine the allowable package dissipation for a given ambient temperature. Alternately, use the following formulas to calculate the allowable package dissipation. For the TDFN package:

$$P_D = \begin{cases} 1.9048W & \text{for } T_A \leq +70^{\circ}C \\ 1.9048W - 0.0238 \frac{W}{^{\circ}C} \times (T_A - 70^{\circ}C) & \text{for } +70^{\circ}C < T_A \leq +125^{\circ}C \end{cases}$$

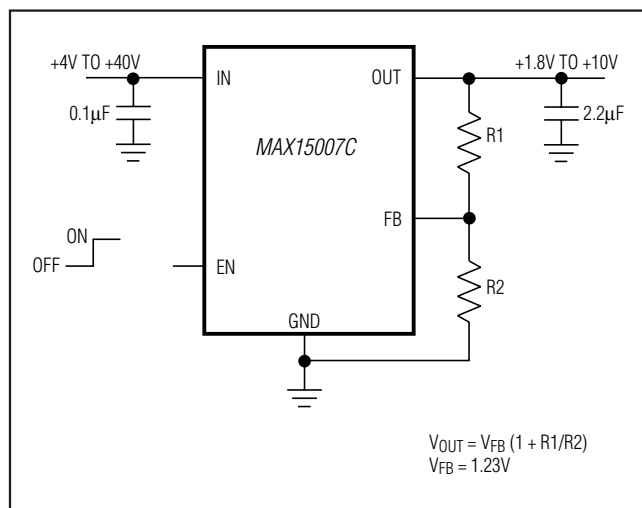

Figure 4. Setting the Adjustable Output Voltage

For the SO-EP package:

$$P_D = \begin{cases} 1.8605W & \text{for } T_A \leq +70^{\circ}C \\ 1.8605W - 0.0233 \frac{W}{^{\circ}C} \times (T_A - 70^{\circ}C) & \text{for } +70^{\circ}C < T_A \leq +125^{\circ}C \end{cases}$$

After determining the allowable package dissipation, calculate the maximum allowable output current, without exceeding the $+150^{\circ}C$ junction temperature, using the following formula:

$$I_{OUT(MAX)} = \frac{P_D}{V_{IN} - V_{OUT}} \leq 50mA$$

The above equations do not include the negligible power dissipation from self-heating due to the IC ground current.

Example 1 (TDFN Package):

$$T_A = +125^{\circ}C$$

$$V_{IN} = 26V$$

$$V_{OUT} = 3.3V$$

Calculate the maximum allowable package dissipation at the given temperature as follows:

$$P_D = 1.9048W - 0.0238 \frac{W}{^{\circ}C} (125^{\circ}C - 70^{\circ}C) = 595.8mW$$

And establish the maximum output current:

$$I_{OUT(MAX)} = \frac{595.8mW}{26V - 3.3V} = 26.2mA$$

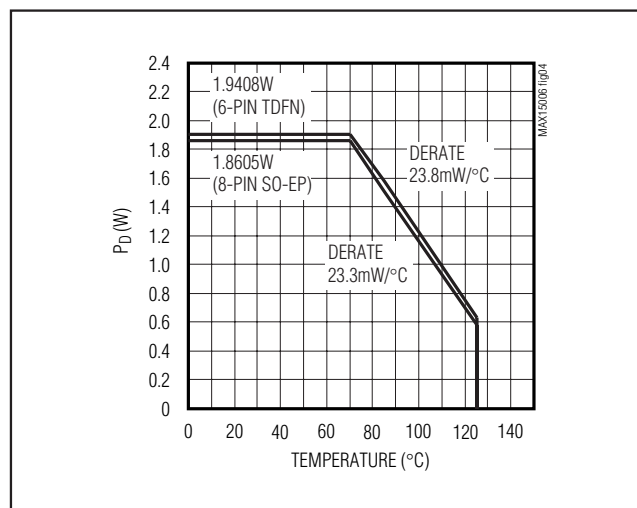

Figure 5. Calculated Maximum Power Dissipation vs. Ambient Temperature

MAX15006/MAX15007

40V, Ultra-Low Quiescent-Current Linear Regulators in 6-Pin TDFN/8-Pin SO

Example 2 (TDFN Package):

$T_A = +85^\circ\text{C}$
 $V_{IN} = 14\text{V}$
 $V_{OUT} = 5\text{V}$

Calculate the maximum allowable package dissipation at the given temperature as follows:

$$P_D = 1.9048\text{W} - 0.0238 \frac{\text{W}}{^\circ\text{C}} (85^\circ\text{C} - 70^\circ\text{C}) = 1.5478\text{W}$$

Then determine the maximum output current:

$$I_{OUT(\text{MAX})} = \frac{1.5478\text{W}}{14\text{V} - 5\text{V}} = 172\text{mA} \Rightarrow I_{OUT(\text{MAX})} = 50\text{mA}$$

Example 3 (TDFN Package):

$T_A = +50^\circ\text{C}$
 $V_{IN} = 9\text{V}$
 $V_{OUT} = 5\text{V}$

Calculate the maximum allowable package dissipation at the given temperature as follows:

$$P_D = 1.9048\text{W}$$

Find the maximum output current:

$$I_{OUT(\text{MAX})} = \frac{1.9048\text{W}}{9\text{V} - 5\text{V}} = 476\text{mA} \Rightarrow I_{OUT(\text{MAX})} = 50\text{mA}$$

In Examples 2 and 3, the maximum output current is calculated as 172mA and 476mA, respectively; however, the allowable output current cannot exceed 50mA.

Alternately, use Figures 6a and 6b to quickly determine the maximum allowable output current for selected ambient temperatures and input voltages.

Output-Capacitor Selection and Regulator Stability

For stable operation over the full temperature range and with load currents up to 50mA, use a low-ESR 2.2µF (min) ceramic or tantalum output capacitor. Use larger output-capacitor values such as 22µF to reduce noise, improve load-transient response, and power-supply rejection.

Some ceramic dielectrics exhibit large capacitance and ESR variations with temperature. Ensure the minimum capacitance under worst-case conditions does not drop below 1.3µF to ensure output stability. With an X7R dielectric, 2.2µF should be sufficient at all operating temperatures.

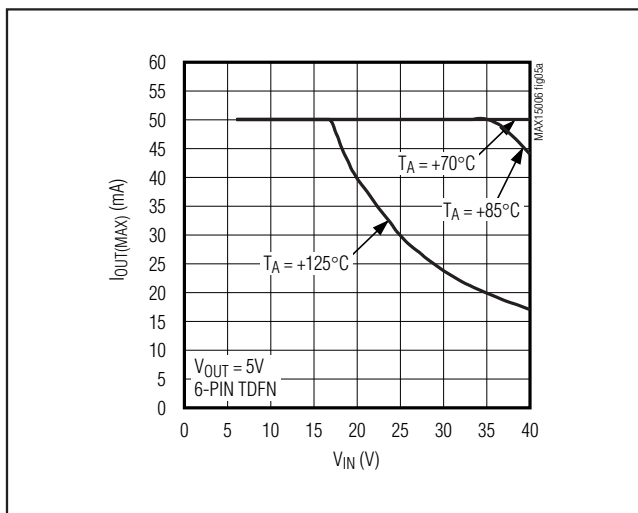

Figure 6a. Calculated Maximum Output Current vs. Input Voltage (6-Pin TDFN-EP)

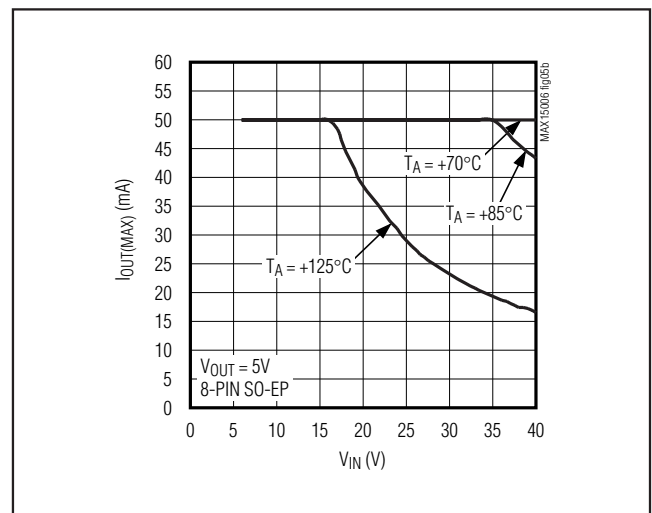

Figure 6b. Calculated Maximum Output Current vs. Input Voltage (8-Pin SO-EP)

MAX15006/MAX15007

40V, Ultra-Low Quiescent-Current Linear Regulators in 6-Pin TDFN/8-Pin SO

Selector Guide

PART	ENABLE INPUT	FIXED OUTPUT VOLTAGE (V)	ADJUSTABLE OUTPUT VOLTAGE (V)	PIN-PACKAGE
MAX15006AASA+	—	3.3	—	8 SO-EP
MAX15006AATT+	—	3.3	—	6 TDFN-EP
MAX15006BASA+	—	5	—	8 SO-EP
MAX15006BATT+	—	5	—	6 TDFN-EP
MAX15006CASA+	—	—	ADJ (1.8 to 10)	8 SO-EP
MAX15006CATT+	—	—	ADJ (1.8 to 10)	6 TDFN-EP
MAX15007AASA+	√	3.3	—	8 SO-EP
MAX15007AATT+	√	3.3	—	6 TDFN-EP
MAX15007BASA+	√	5	—	8 SO-EP
MAX15007BATT+	√	5	—	6 TDFN-EP
MAX15007CASA+	√	—	ADJ (1.8 to 10)	8 SO-EP
MAX15007CATT+	√	—	ADJ (1.8 to 10)	6 TDFN-EP

Pin Configurations (continued)

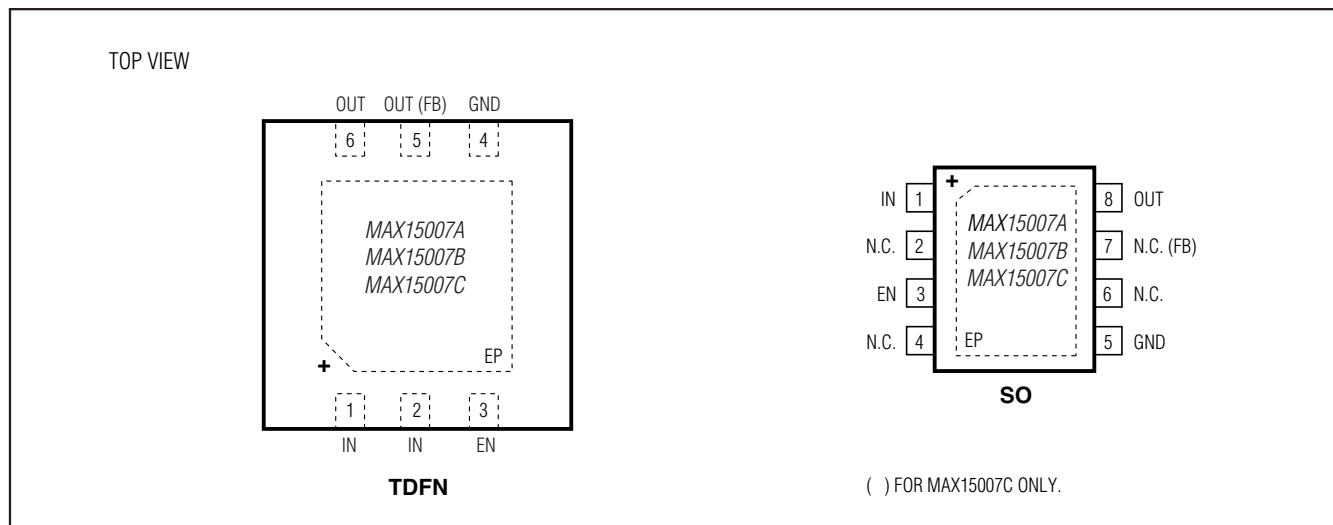

MAX15006/MAX15007

40V, Ultra-Low Quiescent-Current Linear Regulators in 6-Pin TDFN/8-Pin SO

Ordering Information (continued)

PART	TEMP RANGE	PIN-PACKAGE	TOP MARK
MAX15006BASA+	-40°C to +125°C	8 SO-EP*	—
MAX15006BASAV+	-40°C to +125°C	8 SO-EP*	—
MAX15006BATT+	-40°C to +125°C	6 TDFN-EP*	APF
MAX15006BATT/V+	-40°C to +125°C	6 TDFN-EP*	AUN
MAX15006CATT+	-40°C to +125°C	6 TDFN-EP*	API
MAX15006CATT/V+	-40°C to +125°C	6 TDFN-EP*	AVA
MAX15006DATT/V+	-40°C to +125°C	6 TDFN-EP*	AVL
MAX15007AASA+	-40°C to +125°C	8 SO-EP*	—
MAX15007AATT+	-40°C to +125°C	6 TDFN-EP*	APG
MAX15007BASA+	-40°C to +125°C	8 SO-EP*	—
MAX15007BATT+	-40°C to +125°C	6 TDFN-EP*	APH
MAX15007BATT/V+	-40°C to +125°C	6 TDFN-EP*	AVK
MAX15007CATT+	-40°C to +125°C	6 TDFN-EP*	APJ
MAX15007CATT/V+	-40°C to +125°C	6 TDFN-EP*	AUU

+Denotes a lead(Pb)-free/RoHS-compliant package.

/V denotes an automotive qualified part.

*EP = Exposed pad.

Chip Information

PROCESS: BiCMOS

Package Information

For the latest package outline information and land patterns (footprints), go to www.maximintegrated.com/packages. Note that a "+", "#", or "-" in the package code indicates RoHS status only. Package drawings may show a different suffix character, but the drawing pertains to the package regardless of RoHS status.

PACKAGE TYPE	PACKAGE CODE	OUTLINE NO.	LAND PATTERN NO.
6 TDFN-EP	T633+2	21-0137	90-0058
8 SO-EP	S8E+12	21-0111	90-0150

MAX15006/MAX15007

40V, Ultra-Low Quiescent-Current Linear Regulators in 6-Pin TDFN/8-Pin SO

Revision History

REVISION NUMBER	REVISION DATE	DESCRIPTION	PAGES CHANGED
0	10/06	Initial release	—
1	5/08	Added MAX15006C/MAX15007C adjustable version to data sheet including <i>Ordering Information, Electrical Characteristics, Pin Description, and Detailed Description</i>	1–14
2	11/09	Added the MAX15006A/MAX15006B automotive packages to the <i>Ordering Information</i>	1, 13
3	12/10	Added the MAX15006CATT and MAX15007CATT automotive packages to the <i>Ordering Information</i>	13
4	7/11	Added the MAX15006AASA and MAX15006BASA automotive packages to the <i>Ordering Information</i>	1, 13
5	11/11	Changed the maximum $I_{OUT} = 50\text{mA}$ dropout of the MAX15006A/MAX15007A from 700mV to 1000mV	3
6	1/13	Added MAX15006DATT/V and MAX15007BATT/V	1–14



Maxim Integrated cannot assume responsibility for use of any circuitry other than circuitry entirely embodied in a Maxim Integrated product. No circuit patent licenses are implied. Maxim Integrated reserves the right to change the circuitry and specifications without notice at any time. The parametric values (min and max limits) shown in the Electrical Characteristics table are guaranteed. Other parametric values quoted in this data sheet are provided for guidance.

Компания «Океан Электроники» предлагает заключение долгосрочных отношений при поставках импортных электронных компонентов на взаимовыгодных условиях!

Наши преимущества:

- Поставка оригинальных импортных электронных компонентов напрямую с производств Америки, Европы и Азии, а так же с крупнейших складов мира;
- Широкая линейка поставок активных и пассивных импортных электронных компонентов (более 30 млн. наименований);
- Поставка сложных, дефицитных, либо снятых с производства позиций;
- Оперативные сроки поставки под заказ (от 5 рабочих дней);
- Экспресс доставка в любую точку России;
- Помощь Конструкторского Отдела и консультации квалифицированных инженеров;
- Техническая поддержка проекта, помощь в подборе аналогов, поставка прототипов;
- Поставка электронных компонентов под контролем ВП;
- Система менеджмента качества сертифицирована по Международному стандарту ISO 9001;
- При необходимости вся продукция военного и аэрокосмического назначения проходит испытания и сертификацию в лаборатории (по согласованию с заказчиком);
- Поставка специализированных компонентов военного и аэрокосмического уровня качества (Xilinx, Altera, Analog Devices, Intersil, Interpoint, Microsemi, Actel, Aeroflex, Peregrine, VPT, Syfer, Eurofarad, Texas Instruments, MS Kennedy, Miteq, Cobham, E2V, MA-COM, Hittite, Mini-Circuits, General Dynamics и др.);

Компания «Океан Электроники» является официальным дистрибьютором и эксклюзивным представителем в России одного из крупнейших производителей разъемов военного и аэрокосмического назначения «JONHON», а так же официальным дистрибьютором и эксклюзивным представителем в России производителя высокотехнологичных и надежных решений для передачи СВЧ сигналов «FORSTAR».



JONHON

«JONHON» (основан в 1970 г.)

Разъемы специального, военного и аэрокосмического назначения:

(Применяются в военной, авиационной, аэрокосмической, морской, железнодорожной, горно- и нефтедобывающей отраслях промышленности)

«FORSTAR» (основан в 1998 г.)

ВЧ соединители, коаксиальные кабели, кабельные сборки и микроволновые компоненты:

(Применяются в телекоммуникациях гражданского и специального назначения, в средствах связи, РЛС, а так же военной, авиационной и аэрокосмической отраслях промышленности).



Телефон: 8 (812) 309-75-97 (многоканальный)

Факс: 8 (812) 320-03-32

Электронная почта: ocean@oceanchips.ru

Web: <http://oceanchips.ru/>

Адрес: 198099, г. Санкт-Петербург, ул. Калинина, д. 2, корп. 4, лит. А