

ENVIRONMENTALLY SEALED TOGGLE

The T9 Toggle Switch is an ideal switch for demanding applications, compliant to MIL-DTL-3950, this high performance switch is a logical choice for use in environments where sealing and resistance to shock and vibration are required. The T9 is particularly suitable for applications in off-highway, aviation, commercial and industrial equipment. This compact, environmentally sealed switch is available in single and double pole configurations with a lever lockout option. Circuitry configurations include two or three positions with many combinations of OFF/ON in momentary and maintained action including ON-ON-ON.



Quality Features:

- Compliant to MIL-DTL-3950
- Sealed per IP68 or per MIL-DTL-3950
- Electrical life 20,000 cycles full load
- Mechanical life 40,000 cycles
- Lever lockout option available
- Temperature range -65°C – +71°C
- UL, CSA, and CE approvals (pending)
- Maintained and momentary toggle action
- Optional panel seal

T9 Part Number Code



*Optional panel seal P/N 710196

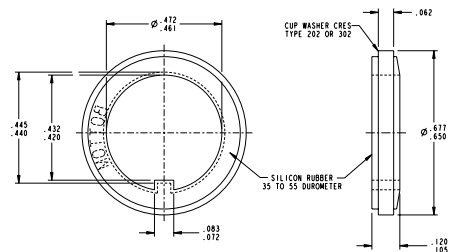

Single Pole

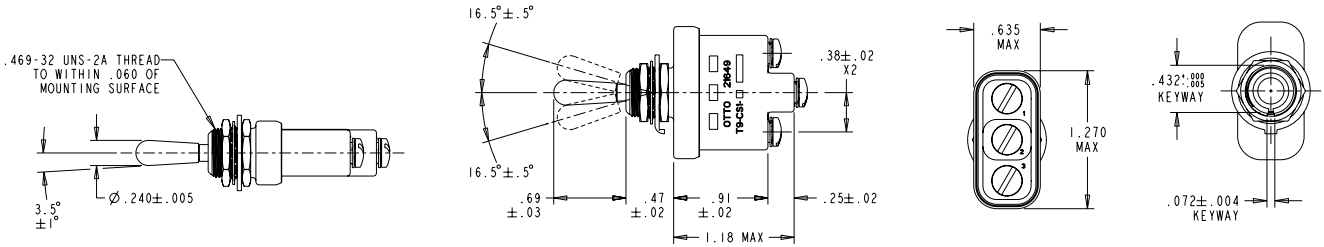

OTTO PART NO.	MILITARY NO.	DASH NO.	CIRCUIT BY TOGGLE LEVER POSITION			ELECTRICAL RATINGS - SEA LEVEL & 65,000 FT					
			KEYWAY 1-2	CENTER	OPP. KEYWAY 2-3	28 VDC			115 VAC		
						LAMP	RESISTIVE	INDUCTIVE	LAMP	RESISTIVE	INDUCTIVE
T9-MS1-	MS24523-	21	ON	OFF	ON	5	20	15	3	15	10
		22	OFF	NONE	ON						
		23	ON	NONE	ON						
		24	NONE	OFF	ON						
		25	NONE	MOM OFF	ON	4	15	10	2	15	7
		26	MOM ON	NONE	ON						
		27	MOM ON	OFF	MOM ON						
		28	MOM ON	OFF	NONE						
		29	MOM OFF	NONE	ON						
		30	MOM ON	NONE	OFF						
31	MOM ON	OFF	ON								
OTTO PART NO.	MILITARY NO.	DASH NO.	KEYWAY	CENTER	OPP. KEYWAY	28 VDC			115 VAC		
T9-MS1-	MS24523-	32	NONE	ON	MOM ON	4	15	10	2	15	7
		33	NONE	ON	ON	5	20	15	3	15	10

Lever/Lock Single Pole

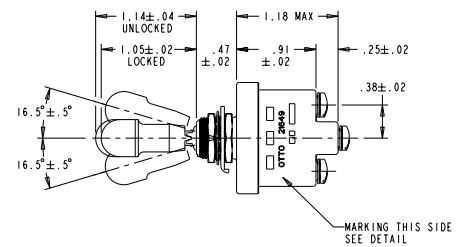
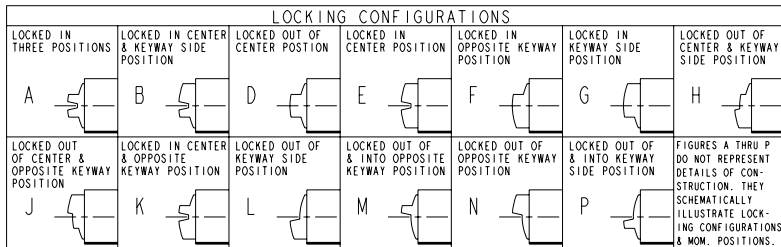

OTTO BASE PART NO.	MILITARY NO.	DASH NO.	AVAILABLE LOCKOUTS (SEE CHART)	CIRCUIT BY TOGGLE LEVER POSITION			ELECTRICAL RATINGS - SEA LEVEL & 65,000 FT					
				KEYWAY 1-2	CENTER	OPP. KEYWAY 2-3	28 VDC			115 VAC		
							LAMP	RESISTIVE	INDUCTIVE	LAMP	RESISTIVE	INDUCTIVE
T9-MS1-	MS24658-	21	ALL	ON	OFF	ON	5	20	15	3	15	10
		22	D F G	OFF	NONE	ON						
		23	D F G	ON	NONE	ON						
		24	E F K M	NONE	OFF (M)	ON						
		25	F	NONE	OFF (M)	ON	4	15	10	2	15	7
		26	F	MOM ON	NONE	ON						
		27	E L N	MOM ON	OFF	MOM ON						
		28	E	MOM ON	OFF	NONE						
		29	F	MOM OFF	NONE	ON						
		30	F	MOM ON	NONE	OFF						
		31	E F K L M N	MOM ON	OFF	ON						
OTTO BASE PART NO.	MILITARY NO.	DASH NO.	AVAILABLE LOCKOUT	KEYWAY	CENTER	OPP. KEYWAY	28 VDC			115 VAC		
T9-MS1-	MS24658-	32	E	NONE	ON	MOM ON	4	15	10	2	15	7
		33	E F K M	NONE	ON	ON	5	20	15	3	15	10

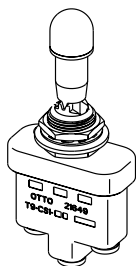

TOGGLE SWITCHES

T9
TOGGLE

Double Pole



OTTO BASE PART NO.	MILITARY STANDARD	DASH NO.	CIRCUIT CONFIGURATION			ELECTRICAL CURRENT RATINGS (AMPS) - SEA LEVEL & 65,000 FT					
			KEYWAY 1-2 / 4-5	CENTER	OPP. KEYWAY 2-3 / 5-6	28 VDC			115 VAC, 60Hz & 400Hz		
						LAMP	RESISTIVE	INDUCTIVE	LAMP	RESISTIVE	INDUCTIVE
T9-MS2-	MS24524-	21	ON	OFF	ON	7	20	15	4	15	10
		22	OFF	NONE	ON						
		23	ON	NONE	ON						
		24	NONE	OFF	ON						
		25	NONE	MOM OFF	ON						
		26	MOM ON	NONE	ON	5	18	10	2	11	8
		27	MOM ON	OFF	MOM ON						
		28	MOM ON	OFF	NONE						
		29	MOM OFF	NONE	ON						
		30	MOM ON	NONE	OFF						
31	MOM ON	OFF	ON								
OTTO BASE PART NO.	MILITARY STANDARD	DASH NO.	KEYWAY	CENTER	OPP. KEYWAY	28 VDC			115 VAC		
T9-MS2-	MS24524-	32	NONE	ON	MOM ON	5	18	10	2	11	8
T9-MS2-	MS24524-	33	NONE	ON	ON	7	20	15	4	15	15



Lever/Lock Double Pole

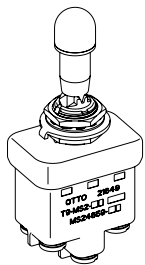
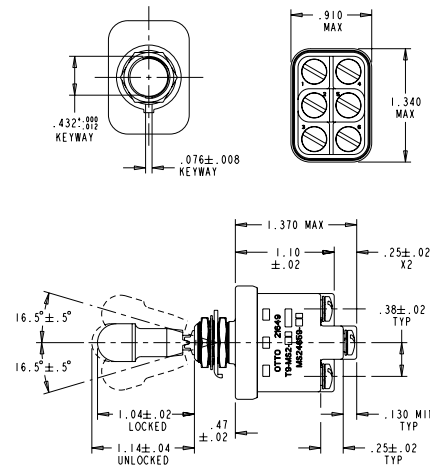

OTTO BASE PART NO.	MILITARY STANDARD	DASH NO.	AVAILABLE LOCKOUTS (SEE CHART)	CIRCUIT CONFIGURATION			ELECTRICAL CURRENT RATINGS (AMPS) - SEA LEVEL & 65,000 FT					
				KEYWAY 1-2 / 4-5	CENTER	OPP. KEYWAY 2-3 / 5-6	28 VDC			115 VAC, 60Hz & 400Hz		
							LAMP	RESISTIVE	INDUCTIVE	LAMP	RESISTIVE	INDUCTIVE
T9-MS2-	MS24659-	21	ALL	ON	OFF	ON	7	20	15	4	15	10
		22	D, F, G	OFF	NONE	ON						
		23	D, F, G	ON	NONE	ON						
		24	E, F, K, M	NONE	OFF	ON						
		25	F	NONE	MOM OFF	ON						
		26	F	MOM ON	NONE	ON	5	18	10	2	11	8
		27	E, L, N	MOM ON	OFF	MOM ON						
		28	E	MOM ON	OFF	NONE						
		29	F	MOM OFF	NONE	ON						
		30	F	MOM ON	NONE	OFF						
		31	E, F, K, L, M, N	MOM ON	OFF	ON						
OTTO BASE PART NO.	MILITARY STANDARD	DASH NO.	E	KEYWAY	CENTER	OPP. KEYWAY	28 VDC			115 VAC		
T9-MS2-	MS24659-	32	E	NONE	ON	MOM ON	5	18	10	2	11	8
T9-MS2-	MS24659-	33	E, F, K, M	NONE	ON	ON	7	20	15	4	15	15

TG SERIES

The TG series toggle guards are offered for two & three position switches with 15 /32 -32 threaded bushings and slotted or flat key-ways. All models feature spring loaded covers that lock in either the open or closed positions. In the open position the switch actuator operates on all positions freely, in the closed position, the switch actuator is locked in the desired position.

The toggle guard is easily installed on the switch from the front panel with two mounting hex nuts and an optional panel seal provided with each switch.

MS approved and QPL'd per MIL-DTL-7703 and MS25224-1

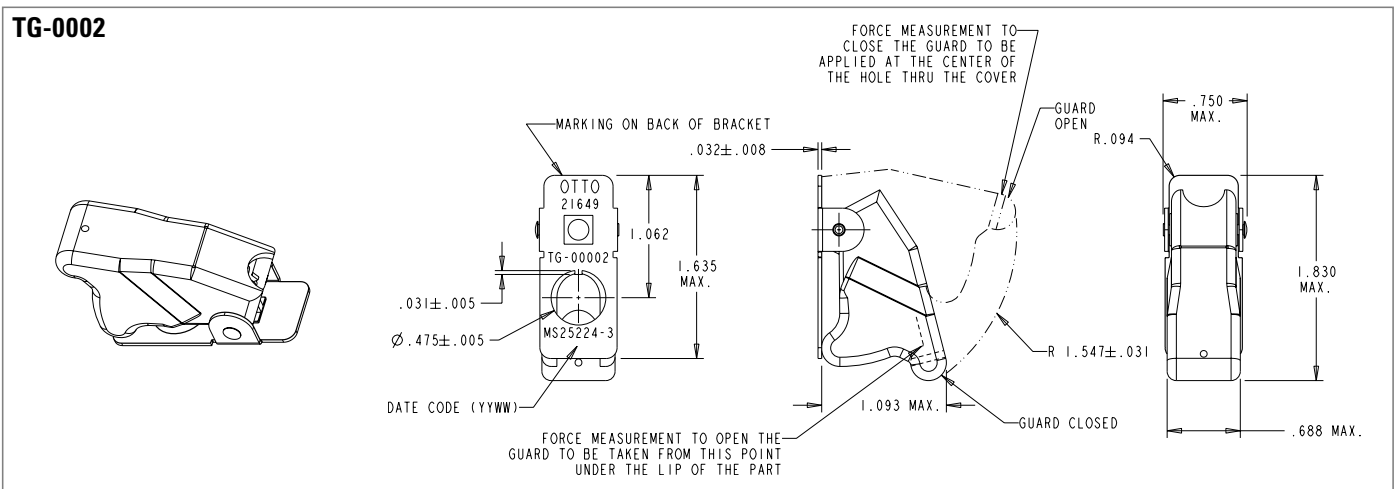
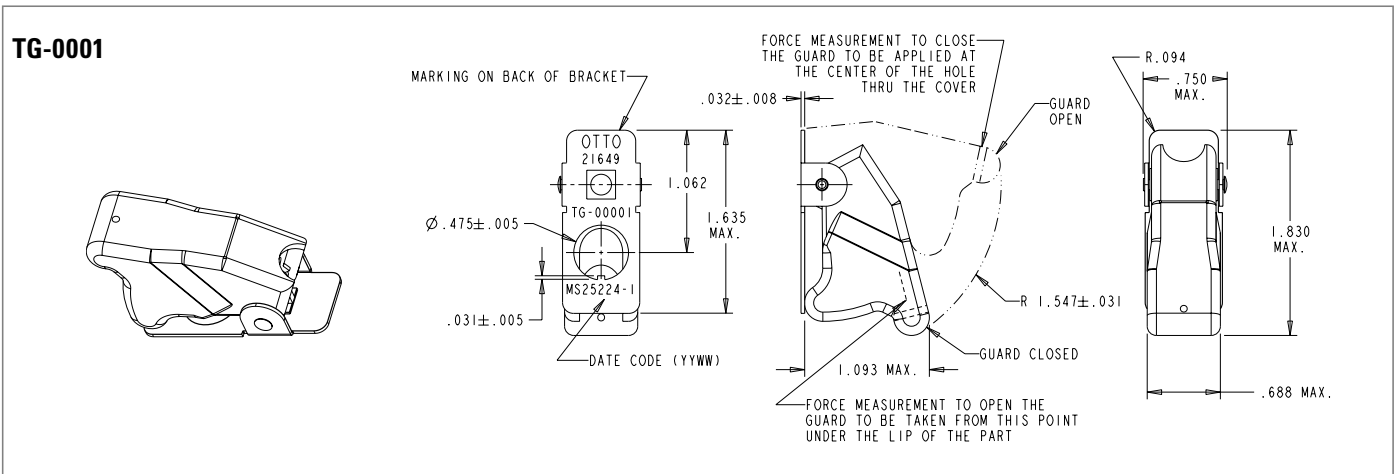
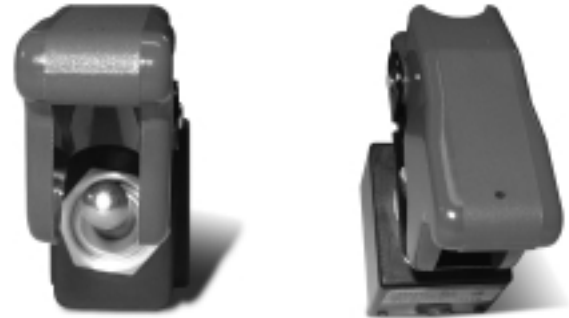

Компания «Океан Электроники» предлагает заключение долгосрочных отношений при поставках импортных электронных компонентов на взаимовыгодных условиях!

Наши преимущества:

- Поставка оригинальных импортных электронных компонентов напрямую с производств Америки, Европы и Азии, а так же с крупнейших складов мира;
- Широкая линейка поставок активных и пассивных импортных электронных компонентов (более 30 млн. наименований);
- Поставка сложных, дефицитных, либо снятых с производства позиций;
- Оперативные сроки поставки под заказ (от 5 рабочих дней);
- Экспресс доставка в любую точку России;
- Помощь Конструкторского Отдела и консультации квалифицированных инженеров;
- Техническая поддержка проекта, помощь в подборе аналогов, поставка прототипов;
- Поставка электронных компонентов под контролем ВП;
- Система менеджмента качества сертифицирована по Международному стандарту ISO 9001;
- При необходимости вся продукция военного и аэрокосмического назначения проходит испытания и сертификацию в лаборатории (по согласованию с заказчиком);
- Поставка специализированных компонентов военного и аэрокосмического уровня качества (Xilinx, Altera, Analog Devices, Intersil, Interpoint, Microsemi, Actel, Aeroflex, Peregrine, VPT, Syfer, Eurofarad, Texas Instruments, MS Kennedy, Miteq, Cobham, E2V, MA-COM, Hittite, Mini-Circuits, General Dynamics и др.);

Компания «Океан Электроники» является официальным дистрибьютором и эксклюзивным представителем в России одного из крупнейших производителей разъемов военного и аэрокосмического назначения «JONHON», а так же официальным дистрибьютором и эксклюзивным представителем в России производителя высокотехнологичных и надежных решений для передачи СВЧ сигналов «FORSTAR».



JONHON

«JONHON» (основан в 1970 г.)

Разъемы специального, военного и аэрокосмического назначения:

(Применяются в военной, авиационной, аэрокосмической, морской, железнодорожной, горно- и нефтедобывающей отраслях промышленности)

«FORSTAR» (основан в 1998 г.)

ВЧ соединители, коаксиальные кабели, кабельные сборки и микроволновые компоненты:

(Применяются в телекоммуникациях гражданского и специального назначения, в средствах связи, РЛС, а так же военной, авиационной и аэрокосмической отраслях промышленности).



Телефон: 8 (812) 309-75-97 (многоканальный)

Факс: 8 (812) 320-03-32

Электронная почта: ocean@oceanchips.ru

Web: <http://oceanchips.ru/>

Адрес: 198099, г. Санкт-Петербург, ул. Калинина, д. 2, корп. 4, лит. А