

## MAX8882/MAX8883

## Dual, Low-Noise, Low-Dropout, 160mA Linear Regulators in SOT23

### General Description

The MAX8882/MAX8883 dual, low-noise, low-dropout linear regulators operate from a +2.5V to +6.5V input and deliver up to 160mA each of continuous current. Both versions offer low output noise and low dropout of only 72mV at 80mA. Designed with an internal P-channel MOSFET pass transistor, the MAX8882/MAX8883 maintain a low 165µA supply current (both LDOs on), independent of the load current and dropout voltage. Other features include short-circuit protection and thermal-shutdown protection. The MAX8882 has a single shutdown input and provides an external reference bypass pin to improve noise performance. The MAX8883 includes two independent logic-controlled shutdown inputs. The MAX8882/MAX8883 are both available in a miniature 6-pin SOT23 package.

### Applications

- µP/DSP Core/IO Power
- Cellular and PCS Telephones
- PDAs and Palmtop Computers
- Notebook Computers
- Digital Cameras
- Hand-Held Instruments

### Ordering Information

PART	SHUT-DOWN	TEMP RANGE	PIN-PACKAGE
MAX8882EUT_*	Single	-40°C to +85°C	6 SOT23-6
MAX8883EUT_*	Dual	-40°C to +85°C	6 SOT23-6

\*See Selector Guide

### Features

- Two LDOs in Tiny SOT23
- Up to 160mA Output Current (each LDO)
- 40µV<sub>RMS</sub> Output Noise (MAX8882)
- 72mV Dropout at 80mA Load
- Low 165µA Operating Supply Current
- 62dB PSRR (greater than 56dB to 100kHz)
- Independent Low-Power Shutdown Controls (MAX8883)
- Thermal-Overload and Short-Circuit Protection
- Output Current Limit

### Selector Guide

PART	V <sub>OUTA</sub>	V <sub>OUTB</sub>	TOP MARK
MAX8882EUTJJ	2.85	2.85	AANR
MAX8882EUTAQ	3.3	2.5	AAPW
MAX8882EUTA5	3.3	1.8	AARY
MAX8882XEUTA5	3.3	N.C.	ACVL
MAX8882EUTQ5	2.5	1.8	AAPX
MAX8882EUTGG	3.0	3.0	AAZT
MAX8883EUTJJ	2.85	2.85	AANS
MAX8883EUTAQ	3.3	2.5	AAPY
MAX8883EUTA5	3.3	1.8	AARZ
MAX8883EUTQ5	2.5	1.8	AAPZ
MAX8883EUTGG	3.0	3.0	AAZU

\*\*\*Other combinations between 1.8V and 3.3V are available in 100mV increments. Contact factory for other versions. Minimum order quantity is 50,000 units.

### Typical Operating Circuit

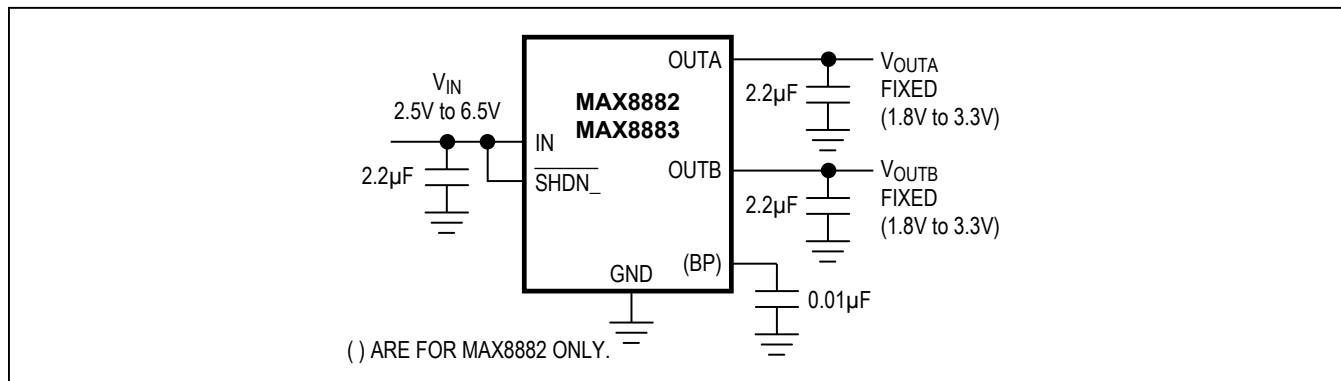

**Absolute Maximum Ratings**

IN, SHDN, SHDNA, SHDNB, BP to GND .....-0.3V to +7.0V  
 OUTA, OUTB to GND.....-0.3V to (VIN + 0.3V)  
 Output Short-Circuit Duration ..... Continuous  
 Continuous Power Dissipation (TA = +70°C)  
 6-Pin SOT23 (derate 8.7mW/°C above +70°C) .....695mW

Operating Temperature Range..... -40°C to +85°C  
 Junction Temperature..... +150°C  
 Storage Temperature Range..... -65°C to +150°C  
 Lead Temperature (soldering, 10s) ..... +300°C

*Stresses beyond those listed under "Absolute Maximum Ratings" may cause permanent damage to the device. These are stress ratings only, and functional operation of the device at these or any other conditions beyond those indicated in the operational sections of the specifications is not implied. Exposure to absolute maximum rating conditions for extended periods may affect device reliability.*

**Electrical Characteristics**

(VIN = +3.6V, SHDN = SHDNA = SHDNB = IN, TA = -40°C to +85°C, unless otherwise noted. Typical values are at TA = +25°C.) (Note 1)

PARAMETER	CONDITIONS	MIN	TYP	MAX	UNITS
Input Voltage		2.5		6.5	V
Undervoltage Lockout Threshold	VIN_ rising, hysteresis 40mV typical	2.15	2.25	2.40	V
Output Voltage Accuracy	TA = +25°C, IOUT_ = 1mA	-1		1	%
	IOUT_ = 1mA	-2		2	
	IOUT_ = 100µA to 160mA	-3		2	
Maximum Output Current	Continuous	160			mA
Current Limit		160		550	mA
Ground Current	No Load, VIN = 6.5V		165	265	µA
	IOUT_ = 80mA, both LDOs		170		
Shutdown Supply Current	SHDN_ = GND, TA = +25°C		0.01	1	µA
	SHDN_ = GND		0.1		
SHDN_ Input Threshold	VIH	1.6			V
	VIL			0.4	
SHDN_ Input Bias Current	SHDN_ = GND or IN, TA = +25°C		0	100	nA
	SHDN_ = GND or IN		0.05		
Dropout Voltage (Notes 2, 3)	IOUT_ = 1mA		1		mV
	IOUT_ = 40mA		36		
	IOUT_ = 80mA		72	144	
Line Regulation	VIN = (VOUT_ + 0.4V or 2.5V) to + 6.5V, IOUT_ = 1mA	-0.2	0	0.2	%/V
Output Voltage Noise	10Hz to 100kHz, C <sub>BP</sub> = 0.01µF, C <sub>OUT_</sub> = 4.7µF, IOUT_ = 1mA		40		µVRMS
	10Hz to 100kHz, C <sub>OUT_</sub> = 4.7µF, IOUT_ = 10mA		320		

Electrical Characteristics (continued)

( $V_{IN} = +3.6V$ ,  $\overline{SHDN} = \overline{SHDNA} = \overline{SHDNB} = IN$ ,  $T_A = -40^{\circ}C$  to  $+85^{\circ}C$ , unless otherwise noted. Typical values are at  $T_A = +25^{\circ}C$ .) (Note 1)

PARAMETER	CONDITIONS	MIN	TYP	MAX	UNITS
Output Voltage AC PSRR	100Hz, $C_{BP} = 0.01\mu F$ , $C_{OUT\_} = 4.7\mu F$		160		dB
	100Hz, $C_{OUT\_} = 4.7\mu F$		10		
Thermal Shutdown Temperature			160		$^{\circ}C$
Thermal Shutdown Hysteresis			10		$^{\circ}C$

**Note 1:** All units are 100% production tested at  $T_A = +25^{\circ}C$ . Limits over the operating temperature range are guaranteed by design.

**Note 2:** The dropout voltage is defined as  $V_{IN} - V_{OUT}$  when  $V_{IN} = V_{OUT}$  (NOM). Specification only applies when  $V_{OUT} \geq 2.5V$ .

**Note 3:** See the *Typical Operating Characteristics* for guaranteed specifications at voltages other than 3.3V.

Typical Operating Characteristics

( $V_{OUT\_} = 2.85V$ ,  $I_{OUT\_} = 80mA$ ,  $V_{IN} = +3.6V$ ,  $C_{OUT\_} = 2.2\mu F$ ,  $C_{BP} = 0.01\mu F$ , and  $C_{IN} = 2.2\mu F$ , unless otherwise noted.)

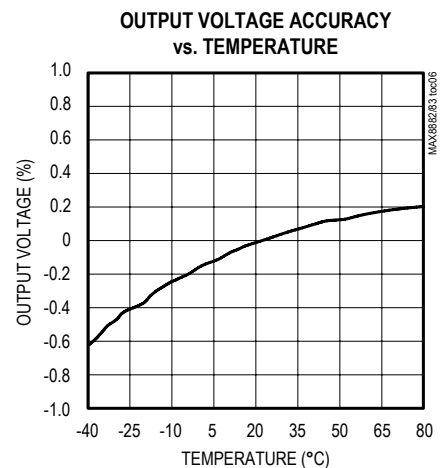
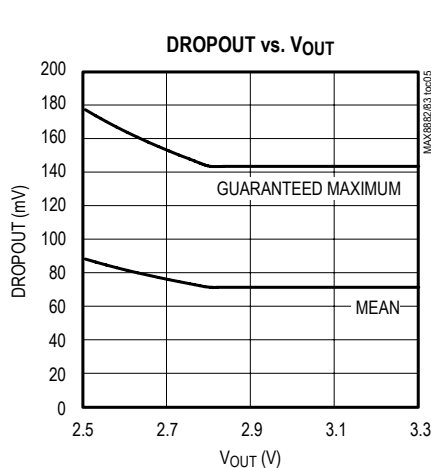
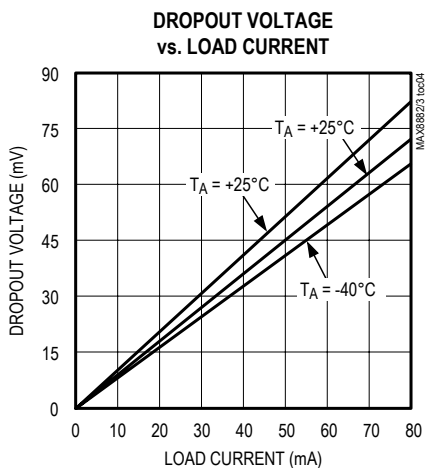
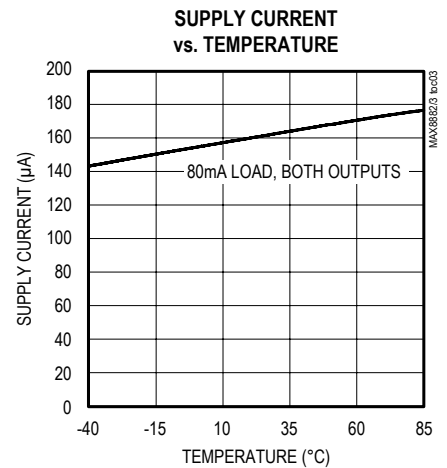
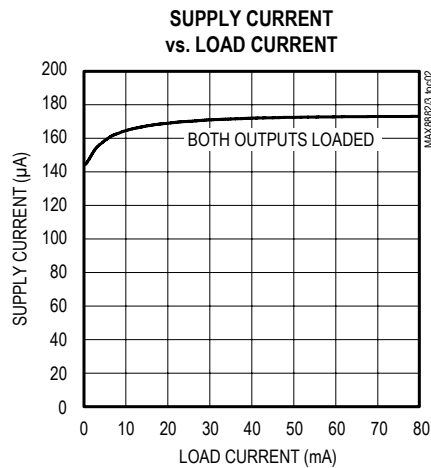
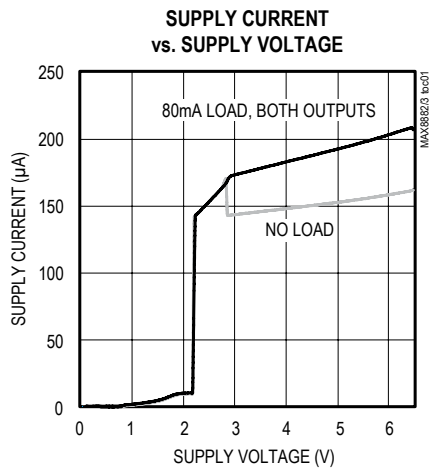

Typical Operating Characteristics (continued)

( $V_{OUT\_} = 2.85V$ ,  $I_{OUT\_} = 80mA$ ,  $V_{IN} = +3.6V$ ,  $C_{OUT\_} = 2.2\mu F$ ,  $C_{BP} = 0.01\mu F$ , and  $C_{IN} = 2.2\mu F$ , unless otherwise noted.)

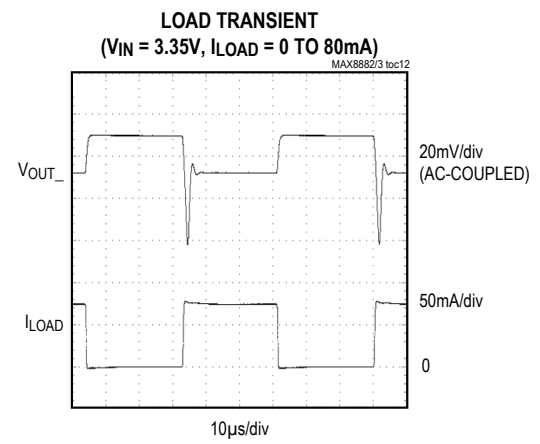
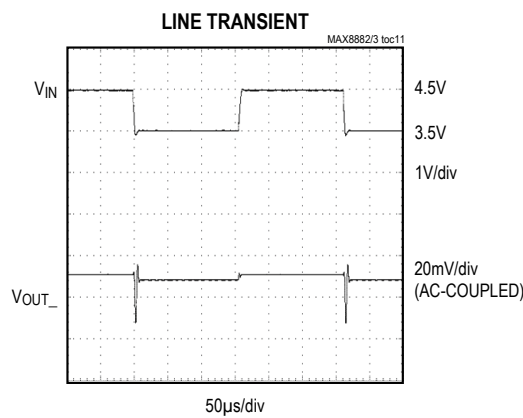
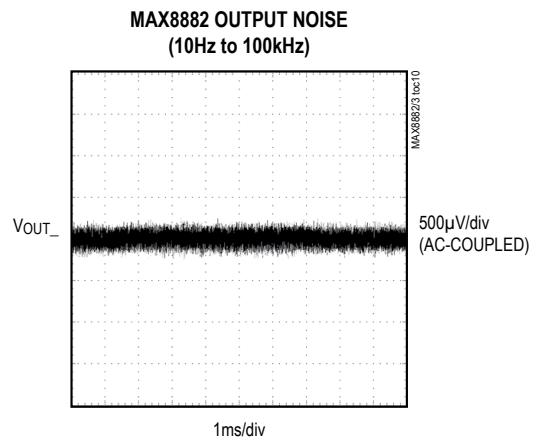
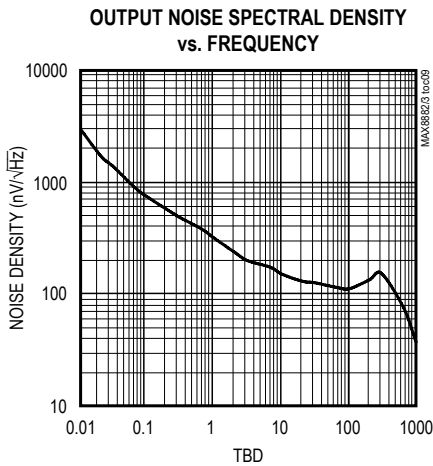
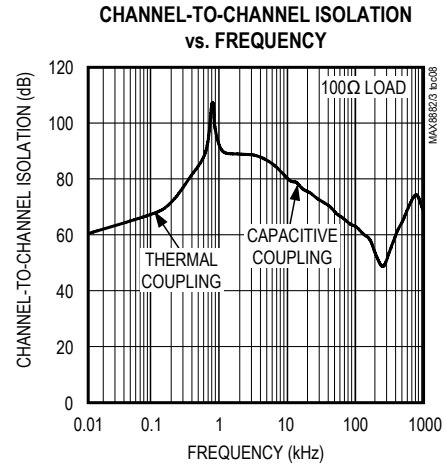
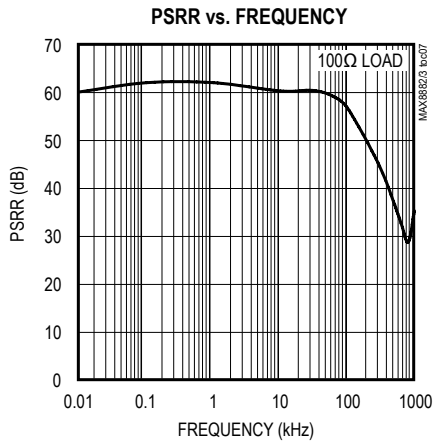

Typical Operating Characteristics (continued)

( $V_{OUT\_} = 2.85V$ ,  $I_{OUT\_} = 80mA$ ,  $V_{IN} = +3.6V$ ,  $C_{OUT\_} = 2.2\mu F$ ,  $C_{BP} = 0.01\mu F$ , and  $C_{IN} = 2.2\mu F$ , unless otherwise noted.)

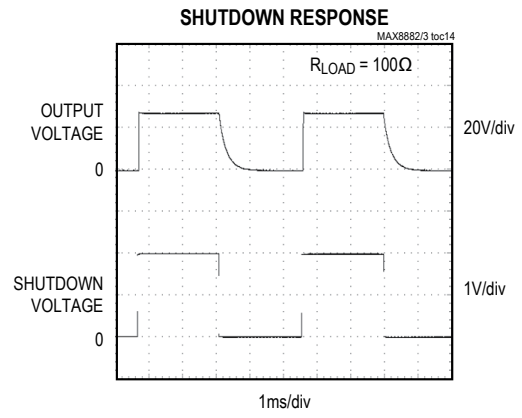
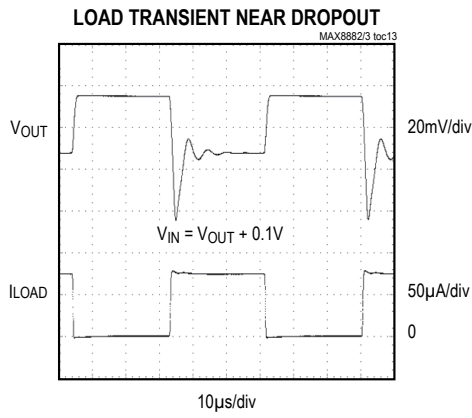

Pin Configurations

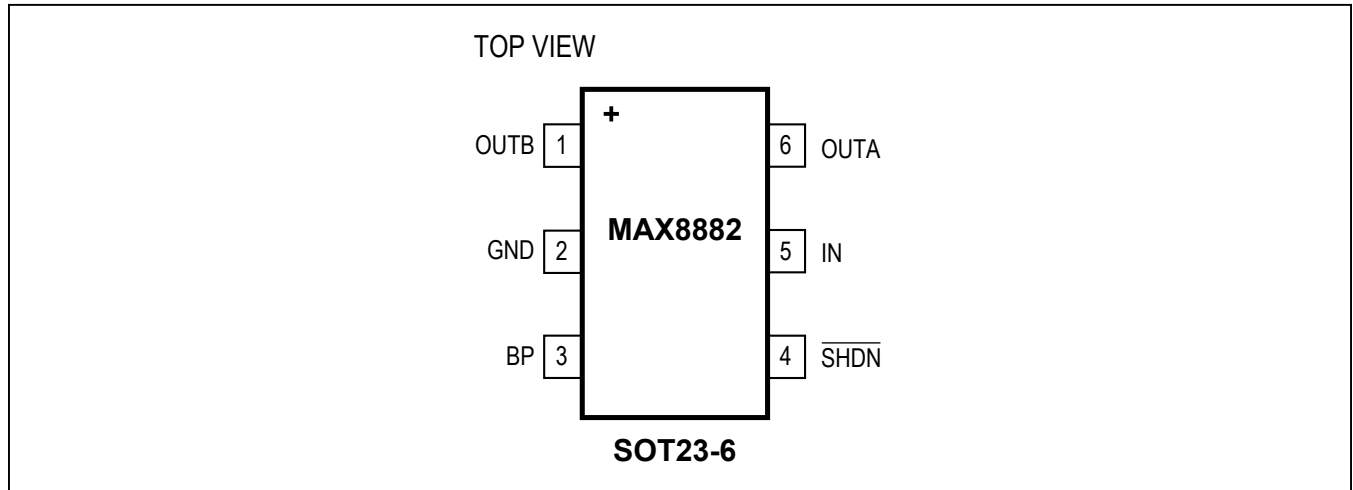

Pin Description

PIN			NAME	FUNCTION
MAX8882	MAX8882X	MAX8883		
1	—	1	OUTB	Regulator B Output. Sources up to 160mA continuous current. Bypass with a 2.2µF (<0.5Ω typ ESR) capacitor to GND (see the <i>Capacitor Selection</i> and <i>Regulator Stability</i> section)
—	1	—	N.C.	No connect for MAX8882XEUTA5+
2	—	2	GND	Ground. This pin also functions as a heatsink. Solder to a large pad or the circuit-board ground plane to maximize thermal dissipation.
3	—	—	BP	Reference Noise Bypass. Bypass with a low-leakage 0.01µF ceramic capacitor for reduced noise at both outputs.
—	—	3	SHDNA	Shutdown A Input. A logic low shuts down regulator A. If SHDNA and SHDNB are both low, both regulators and the reference turn off, and supply current is reduced to 10nA. If either SHDNA or SHDNB is a logic high, the reference is on. Connect to IN for normal operation.
—	—	4	SHDNB	Shutdown B Input. A logic low shuts down regulator B. If SHDNA and SHDNB are both low, both regulators and the reference turn off, and supply current is reduced to 10nA. If either SHDNA or SHDNB is a logic high, the reference is on. Connect to IN for normal operation.
4	—	—	SHDN	Shutdown Input. A logic low shuts down both regulators and the reference, reducing the entire supply current to 10nA. Connect to IN for normal operation.
5	—	5	IN	Regulator Input. Supply voltage can range from +2.5V to +6.5V. This input also supplies the on-chip reference. Bypass with 2.2µF to GND (see the <i>Capacitor Selection</i> and <i>Regulator Stability</i> section).
6	—	6	OUTA	Regulator A Output. Sources up to 160mA continuous current. Bypass with a 2.2µF (<0.5Ω typ ESR) capacitor to GND (see the <i>Capacitor Selection</i> and <i>Regulator Stability</i> section).

## Detailed Description

The MAX8882/MAX8883 are low-noise, low-dropout, low-quiescent-current linear regulators designed primarily for battery-powered applications. These parts are available with preset output voltages ranging from 1.8V to 3.3V, and the parts can supply loads up to 160mA.

### Shutdown

#### MAX8882

The MAX8882 has a single shutdown control input ( $\overline{\text{SHDN}}$ ). Drive  $\overline{\text{SHDN}}$  low to shut down both outputs, reducing supply current to 10nA. Connect  $\overline{\text{SHDN}}$  to a logic-high, or IN, for normal operation.

#### MAX8883

The MAX8883 has independent shutdown control inputs ( $\overline{\text{SHDNA}}$  and  $\overline{\text{SHDNB}}$ ). Drive  $\overline{\text{SHDNA}}$  low to shut down OUTA. Drive  $\overline{\text{SHDNB}}$  low to shut down OUTB. Drive both  $\overline{\text{SHDNA}}$  and  $\overline{\text{SHDNB}}$  low to shut down the entire chip, reducing supply current to 10nA. Connect both  $\overline{\text{SHDNA}}$  and  $\overline{\text{SHDNB}}$  to a logic-high, or IN, for normal operation.

### Internal P-Channel Pass Transistor

The MAX8882/MAX8883 feature two  $1\Omega$  P-channel MOSFET pass transistors. A P-channel MOSFET provides several advantages over similar designs using PNP pass transistors, including longer battery life. It requires no base drive, which reduces quiescent current significantly. PNP-based regulators waste considerable current in dropout when the pass transistor saturates, and they also use high base-drive currents under large loads. The MAX8882/MAX8883 do not suffer from these problems and only consume  $165\mu\text{A}$  of quiescent current whether in dropout, light-load, or heavy-load applications (see the *Typical Operating Characteristics*). While a PNP-based regulator has dropout voltage that is independent of the load, a P-channel MOSFET's dropout voltage is proportional to load current, providing for low dropout voltage at heavy loads and extremely low dropout voltage at lighter loads.

### Current Limit

The MAX8882/MAX8883 contain two independent current limiters, one for each regulator, which monitor and control the pass transistor's gate voltage, limiting the guaranteed maximum output current to 160mA minimum. The output can be shorted to ground for an indefinite time without damaging the part.

### Thermal-Overload Protection

Thermal-overload protection limits total power dissipation in the MAX8882/MAX8883. When the junction tempera-

ture exceeds  $T_J = +160^\circ\text{C}$ , the thermal sensor signals the shutdown logic, turning off the pass transistor and allowing the IC to cool. The thermal sensor will turn the pass transistor on again after the IC's junction temperature cools by  $10^\circ\text{C}$ , resulting in a pulsed output during continuous thermal-overload conditions.

Thermal-overload protection is designed to protect the MAX8882/MAX8883 in the event of fault conditions. For continual operation, do not exceed the absolute maximum junction-temperature rating of  $T_J = +150^\circ\text{C}$ .

### Operating Region and Power Dissipation

The MAX8882/MAX8883's maximum power dissipation depends on the thermal resistance of the case and circuit board, the temperature difference between the die junction and ambient air, and the rate of air flow. The power dissipation across the device is  $P = I_{\text{OUT}} (V_{\text{IN}} - V_{\text{OUT}})$  (Figure 1). The maximum power dissipation is:

$$P_{\text{MAX}} = (T_J - T_A) / (T_{\text{JB}} + T_{\text{BA}})$$

where  $T_J - T_A$  is the temperature difference between the MAX8882/MAX8883 die junction and the surrounding air,  $T_{\text{JB}}$  (or  $T_{\text{JC}}$ ) is the thermal resistance of the package, and  $T_{\text{BA}}$  is the thermal resistance through the printed circuit board, copper traces, and other materials to the surrounding air.

The GND pin of the MAX8882/MAX8883 performs the dual functions of providing an electrical connection to the ground and channeling heat away. Connect the GND pin to ground using a large pad or ground plane.

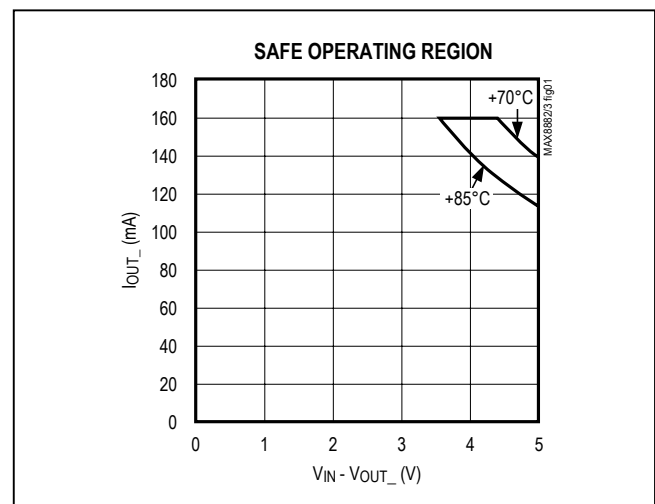

Figure 1. MAX8882/MAX8883 Safe Operating Region

### Low-Noise Operation (MAX8882)

An external 0.01 $\mu$ F bypass capacitor at BP, in conjunction with an internal resistor, creates a lowpass filter. The MAX8882 exhibits 40 $\mu$ V<sub>RMS</sub> of output voltage noise with C<sub>BP</sub> = 0.01 $\mu$ F and C<sub>OUT</sub> = 4.7 $\mu$ F. (See the Output Noise Spectral Density graph in the *Typical Operating Characteristics*.)

## Applications Information

### Capacitor Selection and Regulator Stability

Use a 2.2 $\mu$ F capacitor on the MAX8882/MAX8883 input and a 2.2 $\mu$ F capacitor on the outputs. Larger input capacitor values and lower ESRs provide better supply-noise rejection and line-transient response. To reduce noise, improve load transients, and for loads up to 160mA, use larger output capacitors (up to 10 $\mu$ F). For stable operation over the full temperature range and with load currents up to 80mA, use 2.2 $\mu$ F.

Note that some ceramic dielectrics exhibit large capacitance and ESR variation with temperature. With dielectrics such as Z5U and Y5V, it may be necessary to use 4.7 $\mu$ F or more to ensure stability at temperatures below -10°C. With X7R or X5R dielectrics, 2.2 $\mu$ F is sufficient at all operating temperatures. These regulators are optimized for ceramic capacitors, and tantalum capacitors are not recommended.

Use a 0.01 $\mu$ F bypass capacitor at BP (MAX8882) for low output voltage noise. Increasing the capacitance will slightly decrease the output noise, but increase the startup time. (See the Shutdown Response graph in the *Typical Operating Characteristics*.)

## Pin Configurations (continued)

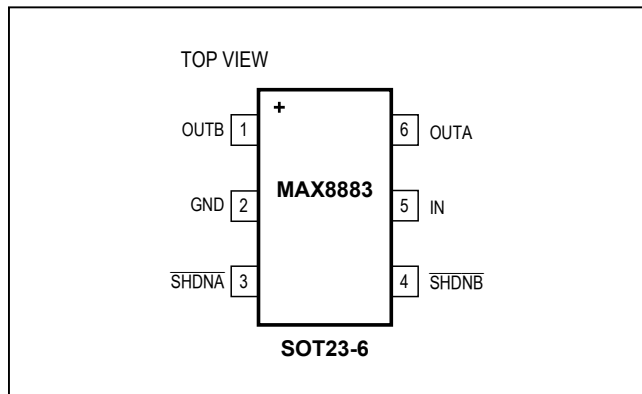

### PSRR and Operation from Sources Other than Batteries

The MAX8882/MAX8883 are designed to deliver low dropout voltages and low quiescent currents in battery-powered systems. Power-supply rejection is 62dB at low frequencies and rolls off above 100kHz. (See the PSRR vs. Frequency graph in the *Typical Operating Characteristics*.)

When operating from sources other than batteries, improved supply-noise rejection and transient response can be achieved by increasing the values of the input and output bypass capacitors and through passive filtering techniques.

### Dropout Voltage

A regulator's minimum input-output voltage differential (or dropout voltage) determines the lowest usable supply voltage. In battery-powered systems, this determines the useful end-of-life battery voltage. Because the MAX8882/MAX8883 use a P-channel MOSFET pass transistor, their dropout voltage is a function of drain-to-source on-resistance (R<sub>DS(ON)</sub>) multiplied by the load current (see the *Typical Operating Characteristics*).

## Chip Information

TRANSISTOR COUNT: 493

PROCESS: BiCMOS



Package Information

For the latest package outline information and land patterns (footprints), go to [www.maximintegrated.com/packages](http://www.maximintegrated.com/packages). Note that a "+", "#", or "-" in the package code indicates RoHS status only. Package drawings may show a different suffix character, but the drawing pertains to the package regardless of RoHS status.

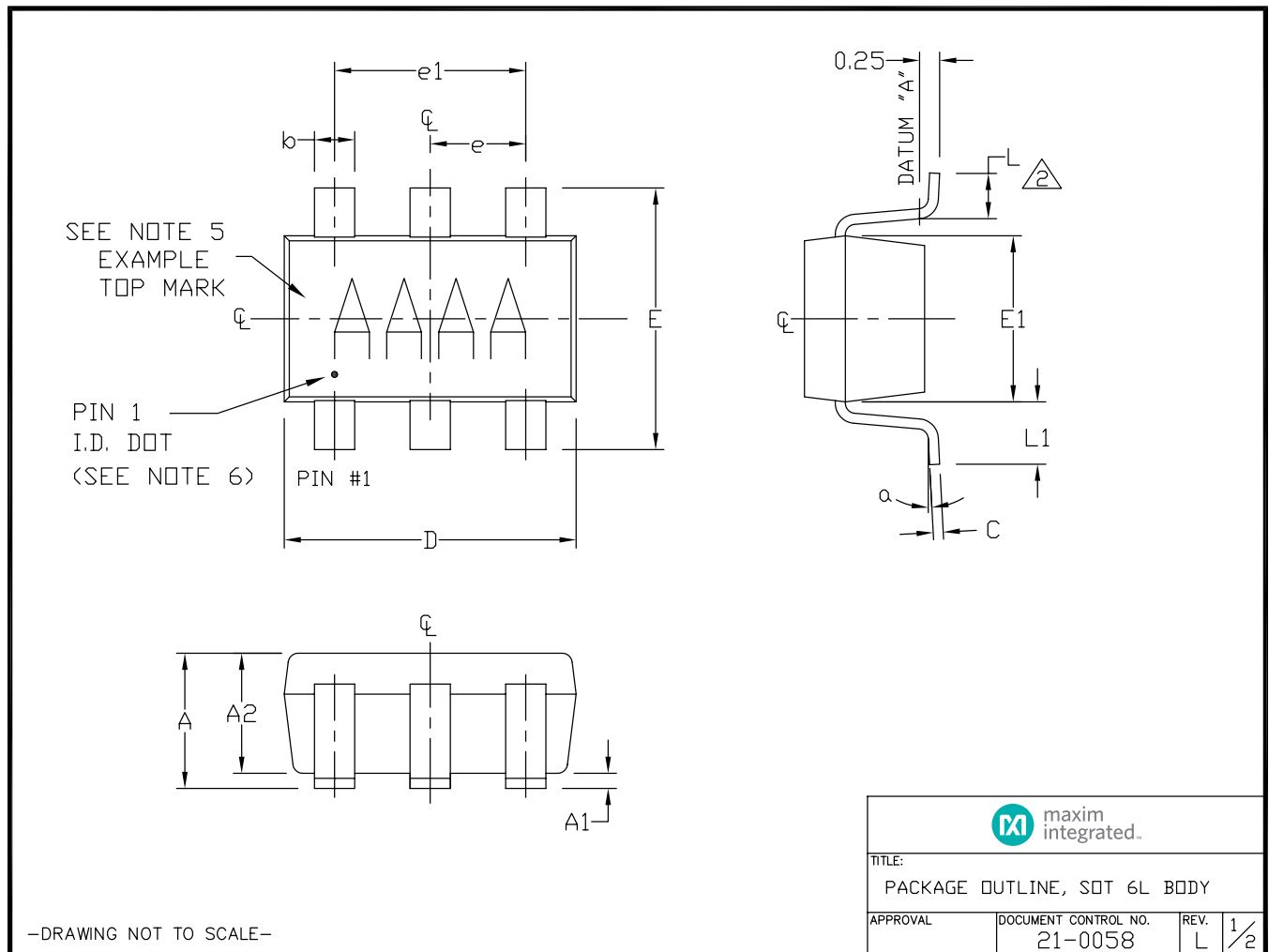

Package Information (continued)

For the latest package outline information and land patterns (footprints), go to [www.maximintegrated.com/packages](http://www.maximintegrated.com/packages). Note that a "+", "#", or "-" in the package code indicates RoHS status only. Package drawings may show a different suffix character, but the drawing pertains to the package regardless of RoHS status.

NOTES:

1. ALL DIMENSIONS ARE IN MILLIMETERS.
2.  FOOT LENGTH MEASURED AT INTERCEPT POINT BETWEEN DATUM A & LEAD SURFACE.
3. PACKAGE OUTLINE EXCLUSIVE OF MOLD FLASH & METAL BURR. MOLD FLASH, PROTRUSION OR METAL BURR SHOULD NOT EXCEED 0.25mm.
4. PACKAGE OUTLINE INCLUSIVE OF SOLDER PLATING.
5. PIN 1 IS LOWER LEFT PIN WHEN READING TOP MARK FROM LEFT TO RIGHT. (SEE EXAMPLE TOP MARK)
6. PIN 1 I.D. DOT IS 0.3mm Ø MIN. LOCATED ABOVE PIN 1.
7. MEETS JEDEC MO178, VARIATION AB.
8. SOLDER THICKNESS MEASURED AT FLAT SECTION OF LEAD BETWEEN 0.08mm AND 0.15mm FROM LEAD TIP.
9. LEAD TO BE COPLANAR WITHIN 0.1mm.
10. NUMBER OF LEADS SHOWN ARE FOR REFERENCE ONLY.
11. MARKING IS FOR PACKAGE ORIENTATION REFERENCE ONLY.
12. ALL DIMENSIONS APPLY TO BOTH LEADED (-) AND P&F FREE (+) PKG. CODES.

SYMBOL	MIN	NOMINAL	MAX
A	0.90	1.25	1.45
A1	0.00	0.05	0.15
A2	0.90	1.10	1.30
b	0.35	0.40	0.50
C	0.08	0.15	0.20
D	2.80	2.90	3.00
E	2.60	2.80	3.00
E1	1.50	1.625	1.75
L	0.35	0.45	0.60
L1	0.60 REF.		
e1	1.90 BSC.		
e	0.95 BSC.		
α	0°	2.5°	10°

PKG CODES:  
 U6-1, U6-2, U6-4, U6CN-2,  
 U6SN-1, U6F-6, U6FH-6; U6FH-7

\*\* U6FH-7 TO BE USED FOR NP42 PARTS ONLY.

-DRAWING NOT TO SCALE-

			
TITLE: PACKAGE OUTLINE, SOT 6L BODY			
APPROVAL	DOCUMENT CONTROL NO. 21-0058	REV. L	2/2

## Revision History

REVISION NUMBER	REVISION DATE	DESCRIPTION	PAGES CHANGED
2	5/18	Updated <i>Selector Guide</i> and <i>Pin Description</i> tables	1, 5

For pricing, delivery, and ordering information, please contact Maxim Direct at 1-888-629-4642, or visit Maxim Integrated's website at [www.maximintegrated.com](http://www.maximintegrated.com).

*Maxim Integrated cannot assume responsibility for use of any circuitry other than circuitry entirely embodied in a Maxim Integrated product. No circuit patent licenses are implied. Maxim Integrated reserves the right to change the circuitry and specifications without notice at any time. The parametric values (min and max limits) shown in the Electrical Characteristics table are guaranteed. Other parametric values quoted in this data sheet are provided for guidance.*

Компания «Океан Электроники» предлагает заключение долгосрочных отношений при поставках импортных электронных компонентов на взаимовыгодных условиях!

Наши преимущества:

- Поставка оригинальных импортных электронных компонентов напрямую с производств Америки, Европы и Азии, а так же с крупнейших складов мира;
- Широкая линейка поставок активных и пассивных импортных электронных компонентов (более 30 млн. наименований);
- Поставка сложных, дефицитных, либо снятых с производства позиций;
- Оперативные сроки поставки под заказ (от 5 рабочих дней);
- Экспресс доставка в любую точку России;
- Помощь Конструкторского Отдела и консультации квалифицированных инженеров;
- Техническая поддержка проекта, помощь в подборе аналогов, поставка прототипов;
- Поставка электронных компонентов под контролем ВП;
- Система менеджмента качества сертифицирована по Международному стандарту ISO 9001;
- При необходимости вся продукция военного и аэрокосмического назначения проходит испытания и сертификацию в лаборатории (по согласованию с заказчиком);
- Поставка специализированных компонентов военного и аэрокосмического уровня качества (Xilinx, Altera, Analog Devices, Intersil, Interpoint, Microsemi, Actel, Aeroflex, Peregrine, VPT, Syfer, Eurofarad, Texas Instruments, MS Kennedy, Miteq, Cobham, E2V, MA-COM, Hittite, Mini-Circuits, General Dynamics и др.);

Компания «Океан Электроники» является официальным дистрибьютором и эксклюзивным представителем в России одного из крупнейших производителей разъемов военного и аэрокосмического назначения «JONHON», а так же официальным дистрибьютором и эксклюзивным представителем в России производителя высокотехнологичных и надежных решений для передачи СВЧ сигналов «FORSTAR».



## JONHON

«JONHON» (основан в 1970 г.)

Разъемы специального, военного и аэрокосмического назначения:

(Применяются в военной, авиационной, аэрокосмической, морской, железнодорожной, горно- и нефтедобывающей отраслях промышленности)

«FORSTAR» (основан в 1998 г.)

ВЧ соединители, коаксиальные кабели, кабельные сборки и микроволновые компоненты:

(Применяются в телекоммуникациях гражданского и специального назначения, в средствах связи, РЛС, а так же военной, авиационной и аэрокосмической отраслях промышленности).



Телефон: 8 (812) 309-75-97 (многоканальный)

Факс: 8 (812) 320-03-32

Электронная почта: [ocean@oceanchips.ru](mailto:ocean@oceanchips.ru)

Web: <http://oceanchips.ru/>

Адрес: 198099, г. Санкт-Петербург, ул. Калинина, д. 2, корп. 4, лит. А