

10034542-XXXXXX

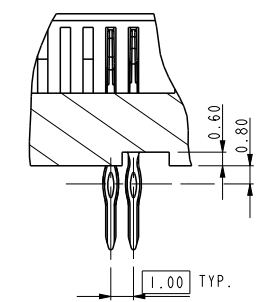

rev	ecn no	dr	date
N	DG07-0306	CS	2007-07-27
P	DG07-0416	CS	2007-10-22
R	DG-15684-1	ERIC	2013-11-08

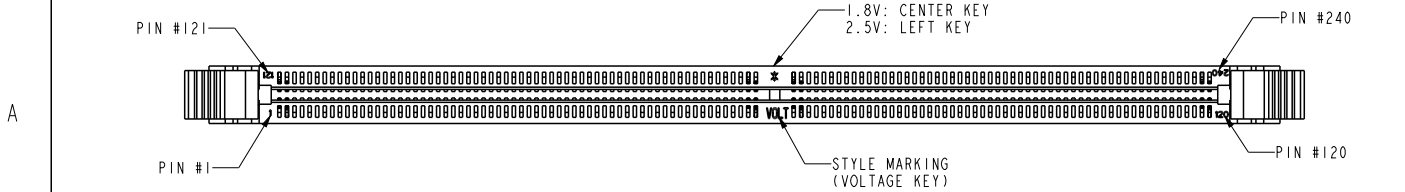

DETAIL A  
SCALE 3.000

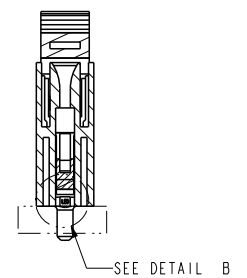
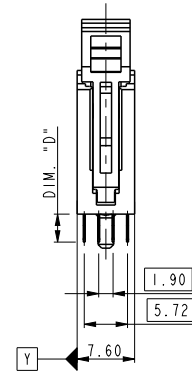
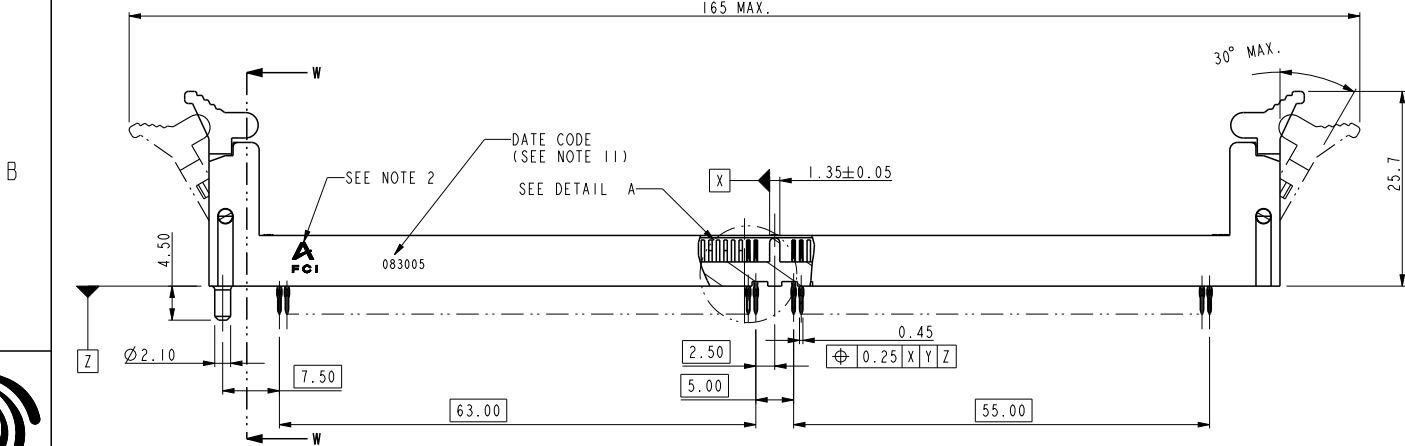

SECTION W-W  
SCALE 1.000

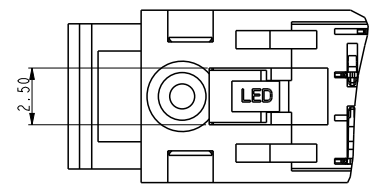
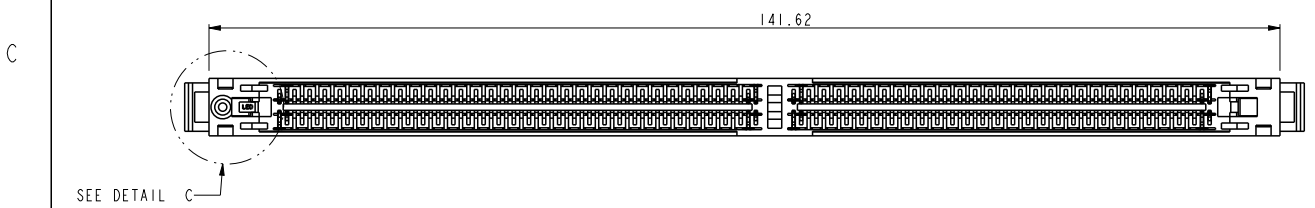

DETAIL C  
SCALE 3.000

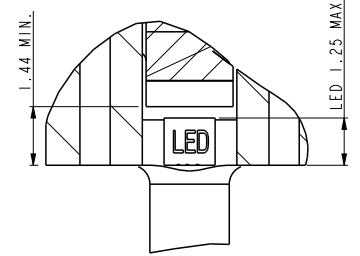

DETAIL B  
SCALE 5.000

FCI  
Copyright FCI.

spec ref	*	dr	Rick Bian	2010/07/03	projection	MM	size	A4	scale	0.500
tolerance std	ASME Y14.5	eng	Eric Jiang	2013/11/25			ecn no	ELX-DG-15684-1		
TOLERANCES UNLESS OTHERWISE SPECIFIED		chr	Tian-Xu Huang	2013/11/25				rel level	Released	
surface	✓	appr	Pei-Ming Zheng	2013/11/25	product family		dwg no		10034542	rev
ASME Y14.5	linear	0.X	±0.38		title		DDR 11 240P PRESS-FIT		sheet 1 of 5	R
		0.XX	±0.25		cat. no.		Product - Customer Drw			
		0.XXX	±0.13		* www.fci.com		STATUS:Released			
	angular	0°	±2°			Printed: Nov 26, 2013				

ProE File - REV C - 2009-06-09

10034542-XXXXXCXX

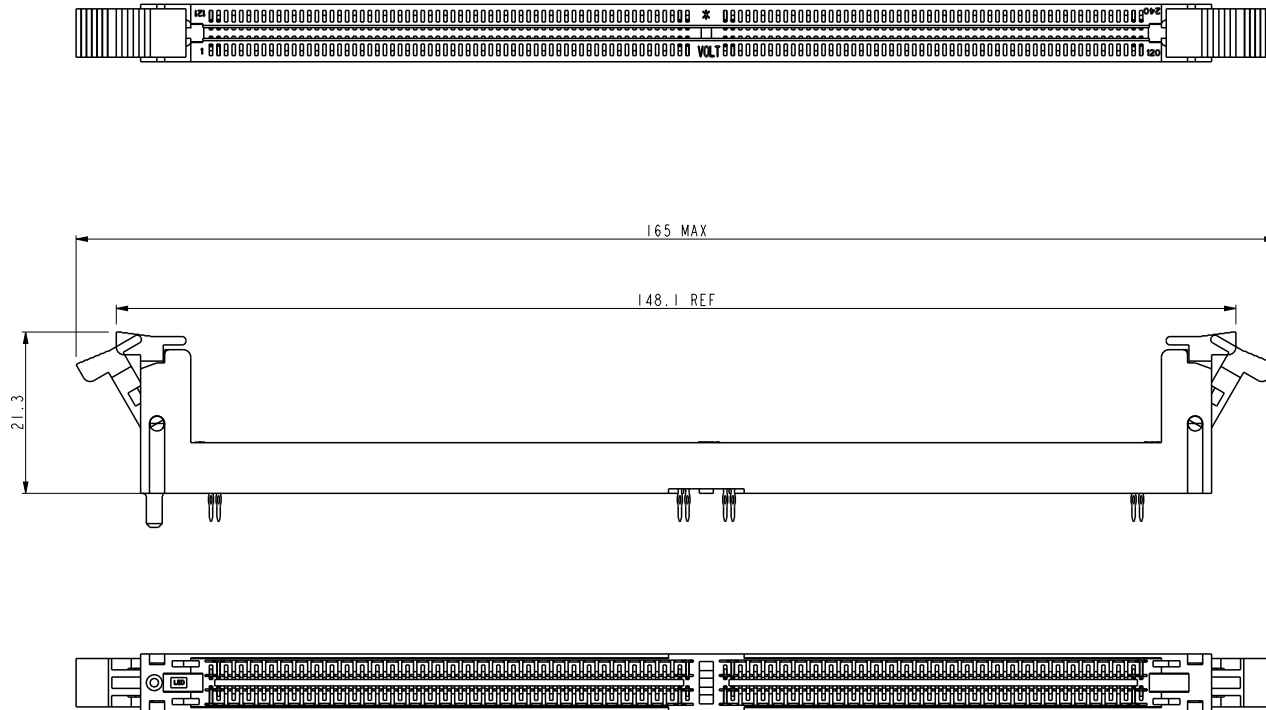

ALL DIMENSIONS ARE SAME TO PAGE 1 EXCEPT MARKED IN THE ABOVE

spec ref		*		dr	Rick Bian	2010/07/03	projection 	MM ←→	size	A4	scale	0.500
tolerance std		TOLERANCES UNLESS OTHERWISE SPECIFIED		eng	Eric Jiang	2013/11/25			ecn no	ELX-DG-15684-1		
ASME Y14.5				chr	Tian-Xu Huang	2013/11/25				rel level		Released
surface		linear	0.X	±0.38	FCI	title	DDR II 240P PRESS-FIT	dwg no	10034542		rev	R
ASME Y14.5			angular	0°								



Copyright FCI.

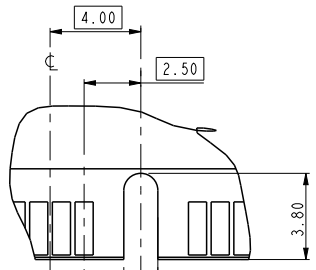
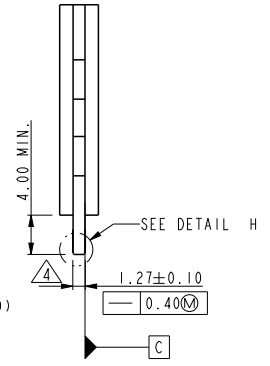
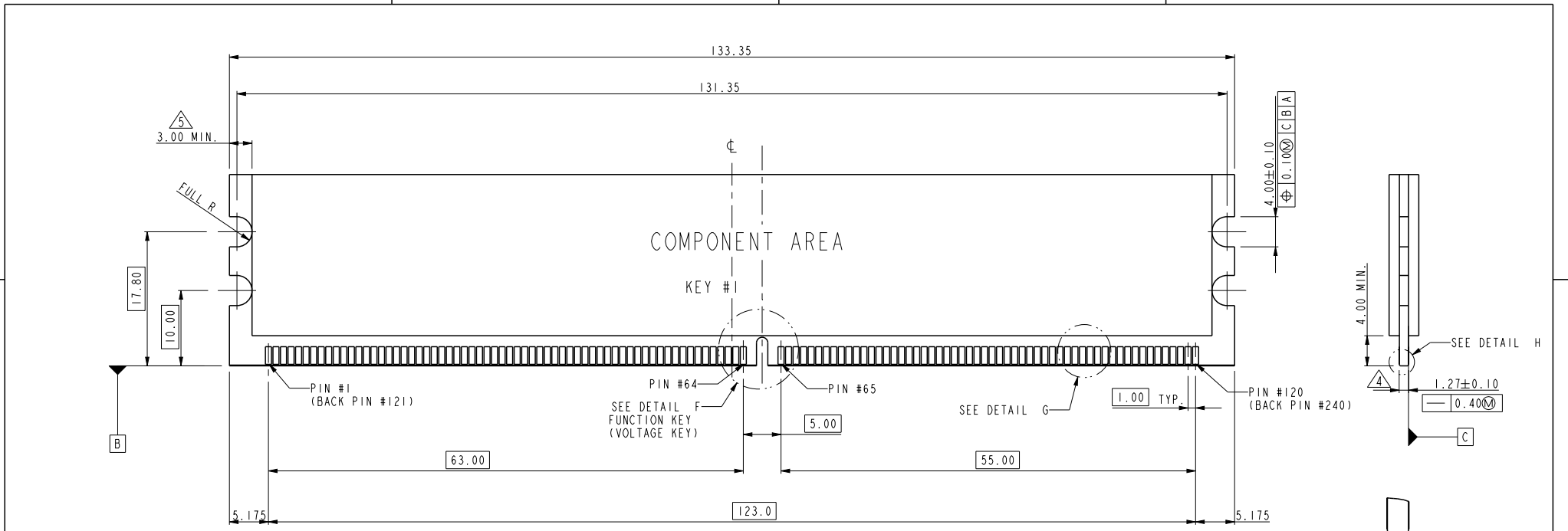

DETAIL F  
KEY POSITION #1  
TYPE "C"

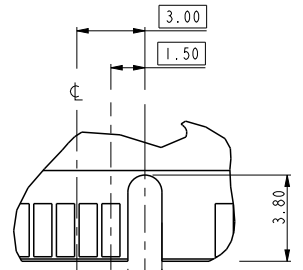

DETAIL F  
KEY POSITION #1  
TYPE "L"

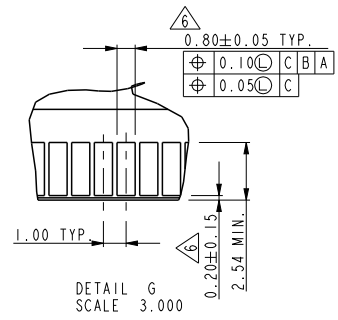

DETAIL G  
SCALE 3.000

NOTE:  
1. MATERIAL : FR-4.  
2. FINISH: SOLDER MASK.  
3. BURR: 0.08 MAX.

SUB KEY POS #1	DESCRIPTION
TYPE "L"	2.5 VOLTAGE
TYPE "C"	1.8 VOLTAGE

spec ref	*	dr	Rick Bian	2010/07/03	projection	MM	size	A4	scale	0.500		
tolerance std	ASME Y14.5	eng	Eric Jiang	2013/11/25			ecn no	ELX-DG-15684-1				
TOLERANCES UNLESS OTHERWISE SPECIFIED		chr	Tian-Xu Huang	2013/11/25				rel level	Released			
surface	linear	appr	Pei-Ming Zheng	2013/11/25	product family		rev	R				
	angular							10034542				
ASME Y14.5	0.X	±0.38		title	DDR II 240P PRESS-FIT	dwg no	10034542	rev	Product - Customer Drw			
	0.XX	±0.25							cat. no.	*	Product - Customer Drw	sheet 3 of 5
	0.XXX	±0.13										
	0°	±2°	www.fci.com									

PrdE File - REV C - 2009-06-09



Copyright FCI.



RECOMMEND CIRCUIT BOARD HOLE LAYOUT

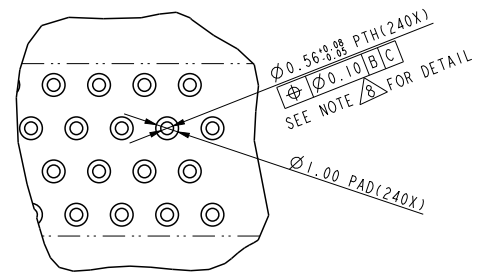

spec ref	*	dr	Rick Bian	2010/07/03	projection	MM	size	A4	scale	0.500			
tolerance std	TOLERANCES UNLESS OTHERWISE SPECIFIED	eng	Eric Jiang	2013/11/25				ecn no	ELX-DG-15684-1				
ASME Y14.5		chr	Tian-Xu Huang	2013/11/25				rel level	Released				
surface		appr	Pei-Ming Zheng	2013/11/25		product family							
ASME Y14.5	linear	0.X	±0.38		title	DDR II 240P PRESS-FIT	dwg no	10034542	rev	R			
		0.XX	±0.25							cat. no.	*	Product - Customer Drw	sheet 4 of 5
	angular	0°	±2°										

PrdE File - REV C - 2009-06-09

10034542-□□□□□□□



STYLE: MECHANICAL KEYING

- 1 : 1.8 VOLT. W/CENTER KEY #1
- 2 : 2.5 VOLT. W/LEFT KEY #1

REVISE

0

TAIL LENGTH

CODE	DIM. "D"
0	3.30
1	3.70
2	4.20

FOR ROHS OPTION:  
 BLANK: TIN LEAD  
 LF: LEAD FREE

FOR LATCH TYPE OPTION:  
 BLANK: TALL LATCH  
 C: SHORT LATCH

CODE	CONTACT	TAIL AREA	UNDERPLATE	CODE	CONTACT	TAIL AREA	UNDERPLATE
2	15u"(0.38um) MIN. GOLD	35u"-100u" Tin PLATING	50u"(1.27um) MIN. NICKEL OVERALL	2B	15u"(0.38um) MIN. GOLD	35u"-100u" Tin/Lead PLATING	50u"(1.27um) MIN. NICKEL OVERALL
3	30u"(0.76um) MIN. GOLD			3B	30u"(0.76um) MIN. GOLD		
4	3u"(0.076um) MIN. GOLD			4B	3u"(0.076um) MIN. GOLD		
6	15u"(0.38um) MIN. GOLD (LUBRICATED)			6B	15u"(0.38um) MIN. GOLD (LUBRICATED)		
7	30u"(0.76um) MIN. GOLD (LUBRICATED)	35u"-100u" Tin PLATING	50u"(1.27um) MIN. NICKEL OVERALL	7B	30u"(0.76um) MIN. GOLD (LUBRICATED)	35u"-100u" Tin/Lead PLATING	50u"(1.27um) MIN. NICKEL OVERALL
8	3u"(0.076um) MIN. GOLD (LUBRICATED)			8B	3u"(0.076um) MIN. GOLD (LUBRICATED)		

NOTE:

- MATERIAL:  
HOUSING: HIGH PERFORMANCE RESINS, GLASS FILLED UL94V-0 RATED, COLOR: BLACK.  
EJECTOR: HIGH PERFORMANCE RESINS, GLASS FILLED UL94V-0 RATED, COLOR: NATURAL.  
TERMINAL: COPPER ALLOY.
- FCI LOGO TO BE APPROXIMATELY LOCATED AS SHOWN ON PRINT.
- PRODUCT SPECIFICATION: GS-12-273
- CARD THICKNESS APPLIES ACROSS TABS AND INCLUDES PLATING AND / OR METALIZATION.
- 3.00mm MINIMUM APPLIES TO BOTH 4.00mm WIDE NOTCH LENGTH AND COMPONENT KEEPOUT AREA.
- LEADING EDGE OF CONTACT PADS SPECIFIED BY THE KEEP OUT ZONE SHALL BE FREE OF BURRS AND EXTERNAL TIE BARS.  
FOR OPTIMUM PERFORMANCE, THE TIE BAR IS TO BE ON AN INTERNAL LAYER SO THAT THE REMNANT CANNOT CAUSE CONTACT DAMAGE.
- PACKAGING SPECIFICATION: GS-14-528.
- ALL PTH SHOULD BE 0.66mm DIA DRILLED AND 0.025mm MIN. ELECTRO-DEPOSITED COPPER THK ON THROUGH HOLE WALL.
- THIS PRODUCT MEETS EUROPEAN UNION DIRECTIVES AND OTHER COUNTRY REGULATIONS AS DESCRIBED IN GS-22-008.
- THE HOUSING WILL WITHSTAND EXPOSURE TO 260° PEAK TEMPERATURE FOR 20 SECONDS IN A IR REFLOW OVEN.

DATE CODE: X X X X X X

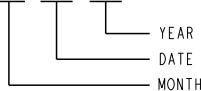

COLOR OF HOUSING AN EJECTOR

- 0 : BLACK HOUSING + IVORY EJECTOR
- 1 : BLACK HOUSING + AMBER EJECTOR
- 2 : BLACK HOUSING + BLACK EJECTOR
- 3 : BLUE HOUSING + IVORY EJECTOR
- 4 : BLUE HOUSING + AMBER EJECTOR

dr	Rick Bian	2010/07/03	projection 	MM 	size	A4	scale	0.500
eng	Eric Jiang	2013/11/25			ecn no	ELX-DG-15684-1		
chr	Tian-Xu Huang	2013/11/25			rel level	Released		
appr	Pei-Ming Zheng	2013/11/25	product family				rev	R
		title	DDR II 240P PRESS-FIT		dwg no	10034542		
www.fci.com		cat. no.	*	Product - Customer Drw			sheet 5 of 5	

12. A SYMBOL WILL BE NEXT TO ANY DIMENSION, VIEW, OR NOTE WHICH HAS BEEN MODIFIED WITH THE CURRENT DRAWING REVISION

FCI  
Copyright FCI.

Компания «Океан Электроники» предлагает заключение долгосрочных отношений при поставках импортных электронных компонентов на взаимовыгодных условиях!

Наши преимущества:

- Поставка оригинальных импортных электронных компонентов напрямую с производств Америки, Европы и Азии, а так же с крупнейших складов мира;
- Широкая линейка поставок активных и пассивных импортных электронных компонентов (более 30 млн. наименований);
- Поставка сложных, дефицитных, либо снятых с производства позиций;
- Оперативные сроки поставки под заказ (от 5 рабочих дней);
- Экспресс доставка в любую точку России;
- Помощь Конструкторского Отдела и консультации квалифицированных инженеров;
- Техническая поддержка проекта, помощь в подборе аналогов, поставка прототипов;
- Поставка электронных компонентов под контролем ВП;
- Система менеджмента качества сертифицирована по Международному стандарту ISO 9001;
- При необходимости вся продукция военного и аэрокосмического назначения проходит испытания и сертификацию в лаборатории (по согласованию с заказчиком);
- Поставка специализированных компонентов военного и аэрокосмического уровня качества (Xilinx, Altera, Analog Devices, Intersil, Interpoint, Microsemi, Actel, Aeroflex, Peregrine, VPT, Syfer, Eurofarad, Texas Instruments, MS Kennedy, Miteq, Cobham, E2V, MA-COM, Hittite, Mini-Circuits, General Dynamics и др.);

Компания «Океан Электроники» является официальным дистрибьютором и эксклюзивным представителем в России одного из крупнейших производителей разъемов военного и аэрокосмического назначения «JONHON», а так же официальным дистрибьютором и эксклюзивным представителем в России производителя высокотехнологичных и надежных решений для передачи СВЧ сигналов «FORSTAR».



## JONHON

«JONHON» (основан в 1970 г.)

Разъемы специального, военного и аэрокосмического назначения:

(Применяются в военной, авиационной, аэрокосмической, морской, железнодорожной, горно- и нефтедобывающей отраслях промышленности)

«FORSTAR» (основан в 1998 г.)

ВЧ соединители, коаксиальные кабели, кабельные сборки и микроволновые компоненты:

(Применяются в телекоммуникациях гражданского и специального назначения, в средствах связи, РЛС, а так же военной, авиационной и аэрокосмической отраслях промышленности).



Телефон: 8 (812) 309-75-97 (многоканальный)

Факс: 8 (812) 320-03-32

Электронная почта: [ocean@oceanchips.ru](mailto:ocean@oceanchips.ru)

Web: <http://oceanchips.ru/>

Адрес: 198099, г. Санкт-Петербург, ул. Калинина, д. 2, корп. 4, лит. А