

Miniature Waterproof Shielded Connectors

LF Series



■ Features

1. Ease of shielded termination and connector assembly

All components are self-aligning and do not require complex assembly tooling. The shield of the cable is connected with the metal housing of the connector using simple shielding clamp, supplied with the connector.

2. Water and dust protected

IP68 protection rating. Complete protection against dust penetration and against water penetration when mated assembly is submerged at the depth of 1.8 meter for 48 hours.

3. Bayonet lock

Short turn bayonet lock assures secure vibration resistant mating of the connectors.

4. Acquired safety standard

4 pos. is 10A and meets safety standards (TÜV)
Also 3- and 4-pos. have acquired the UL standard.

5. High current rating capacity

Number of contacts	Current rating
3	5A max.
4	10A max.
6, 12 and 20	2A max.
11	10A max. 2A max.

Mated dimensions (Example : LF07)

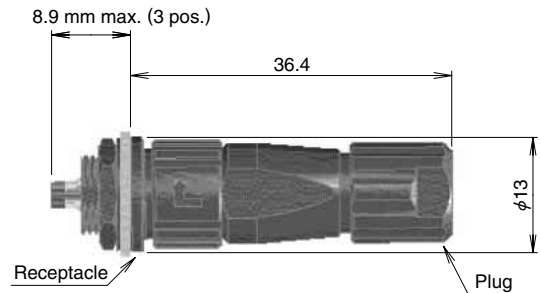

Short turn bayonet lock

Mating:

Insert the plug, and then turn the locking collar clockwise, as indicated by the coupling direction marking.

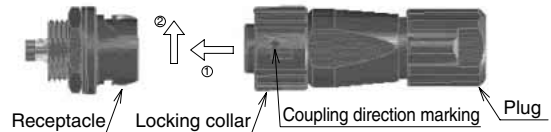

Un-mating:

Turn the locking collar counter-clockwise then pull off the plug.

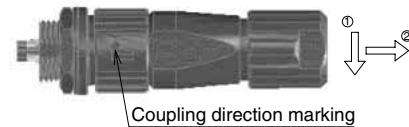

Shielding Connection - Plug

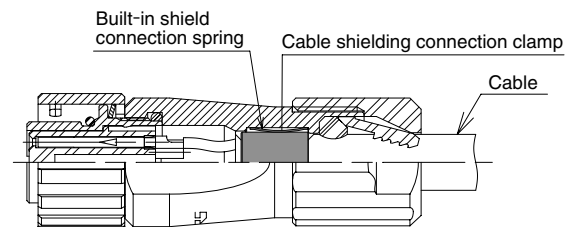

Product Specifications

Rating	Voltage rating	125V AC, 175V DC (3 pos.) 125V AC, 125V DC (4 pos.) 30V AC, 42V DC (6 pos., 12pos., 20pos.) 125V AC, DC (11 pos. A to D) 30V AC, 42V DC (11 pos. 1 to 7)
	Current rating	5A max. (3 pos.) 10A max. (4 pos.) 2A max. (6 pos., 12pos., 20pos.) 10A(11 pos. A to D), 2A(11 pos. 1 to 7)
	Operating temperature range	-25°C to +85°C (Note 1)
	Storage temperature range	-10°C to +60°C (Note 2)

Item	Specification	Conditions
1.Contact resistance	15 mΩ max. (3, 6, 12, 20 pos.) 5 mΩ max. (4 pos.) 5 mΩ max. (A to D), 15mΩ max. (1 to 7)(11 pos.)	1A DC
2.Insulation resistance	1000 MΩ min.	500V DC (3, 4 pos.) 100V DC (6, 12, 20 pos.) 500V DC (A to D), 100V DC (1 to 7)(11pos.)
3.Withstanding voltage	No flashover or insulation breakdown.	1250V AC/one minute (3, 4 pos.) 300V AC/one minute (6, 12, 20 pos.) 1250V AC(A to D),300V AC(1 to 7) / one minute(11pos.)
4.Vibration	No electrical discontinuity for 10μs max.	Frequency: 10 to 55Hz, single amplitude of 0.75mm, acceleration of 98 m/s ² for 3 hours in 3 axis.
5.Shock	No electrical discontinuity for 10μs max.	Acceleration of 490m/s ² , 11ms duration, sine half-wave waveform, 3 cycles in each of the 3 axis.
6.Durability (Mating/un-mating)	30 mΩ max. (3, 6, 12, 20 pos.) 10 mΩ max. (4 pos.) 10 mΩ max.(A to D), 30 mΩ max.(1 to 7)(11pos.)	1000 cycles
7.Temperature cycle	Insulation resistance: 100 MΩ min.	Temperature: -55°C → Room temperature → +125°C → Room temperature Time: 30 → 2 to 3 → 30 → 2 to 3 (minutes) 5 cycles
8.Humidity	Insulation resistance: 10 MΩ min. (When temperature high) Insulation resistance: 100 MΩ min. (Dry state)	96 hours at temperature of 40°C and humidity of 90% to 95%.
9.Water / dust protection	When mated with corresponding connector.	Complete dust protection. No water penetration when submerged for 48 hours at the depth of 1.8 meter.

Note 1: Includes temperature rise caused by the current flow.

Note 2: The term "storage" refers to products stored for long period of time prior to mounting and use. Operating temperature range and humidity range covers non-conducting condition of installed connectors in storage, shipment or during transportation.

Materials / Finish

Components	Material	Finish / Color	Remarks
Body / back shell	Zinc alloy	Nickel plated	_____
Insulator	PPS	Black	UL94V-0
Contacts	Copper alloy	Gold plated	_____
Gasket	Chloroprene rubber	Black	_____

Ordering Information

Please determine the specific product. If listed needed, please select and order the product No.

LF 07 - W B P* - 6 S

① ② ③ ④ ⑤ ⑥ ⑦

① Series name	: LF
② Shell size	07 10 13
③ Waterproof	W : Waterproof type
④ Lock Mechanism	B : Bayonet lock
⑤ Connector type	P : Plug R : Receptacle J : Jack (*:Form change zoning symbols in an identical class)
⑥ Number of contacts	: 3, 4, 6, 11, 12, 20
⑦ Contact type	P : Male contact S : Female contact

■Plugs

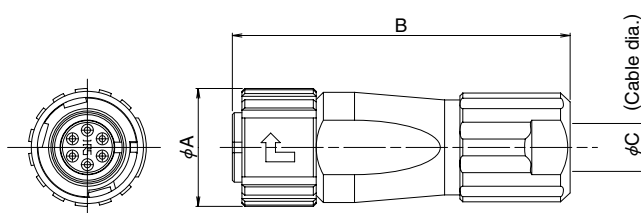

(Shown one example)

Unit:mm

Part number	CL No.	Contact	Number of contacts	ϕA	B	ϕC	Weight
LF07WBP-3S	136-0003-7	Female	3	12.3	35.8	5	11g
LF07WBP-3P	136-0004-0	Male					
LF07WBP-6S	136-0001-1	Female	6	12.3	35.8	5	11g
LF07WBP-6P	136-0002-4	Male					
LF10WBP-4S	136-0005-2	Female	4	14.8	41.8	7.3	17g
LF10WBP-4P	136-0006-5	Male					
LF10WBP-12S	136-0007-8	Female	12	14.8	41.8	7.3	17g
LF10WBP-12P	136-0008-0	Male					
LF13WBP-20S	136-0009-3	Female	20	17.9	51.9	8.7	29g
LF13WBP-20P	136-0010-2	Male					
LF13WBP-11S	136-0011-5	Female	11	17.9	51.9	8.7	29g
LF13WBP-11P	136-0012-8	Male					

■Plugs

●Lock ease type

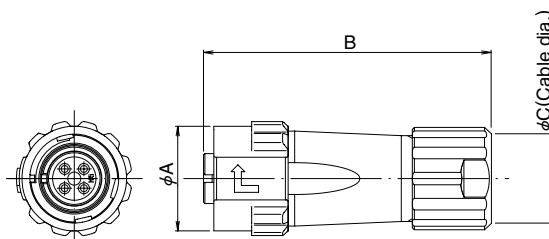

Unit:mm

Part number	CL No.	Contact	Number of contacts	ϕA	ϕB	C	Weight
LF10WBPD-4S	136-0014-3-00	Male	4	16.8	41.8	7.3	19g
LF10WBPD-4P	136-0017-1-00	Female					
LF10WBPD-12S	136-0015-6-00	Male	12	16.8	41.8	7.3	19g
LF10WBPD-12P	136-0018-4-00	Female					

■Receptacles

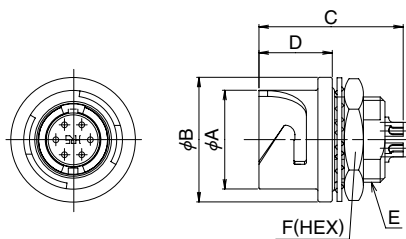

Unit:mm

Part number	CL No.	Contact	Number of contacts	ϕA	ϕB	C	D	E	F	Weight						
LF07WBR-3P	136-1003-2	Male	3	10.3	13	16.55	7.65	M9×0.75	11	4g						
LF07WBR-3S	136-1004-5	Female														
LF07WBR-6P	136-1001-7	Male	6			15.05										
LF07WBR-6S	136-1002-0	Female				15.25										
LF10WBR-4P	136-1005-8	Male	4			12.8					15.3	19.05	7.75	M11×0.75	13	6g
LF10WBR-4S	136-1006-0	Female														
LF10WBR-12P	136-1007-3	Male	12	17.25												
LF10WBR-12S	136-1008-6	Female														
LF13WBR-20P	136-1009-9	Male	20	15.9	18.3		17.25	7.75	M14×0.75	17		9g				
LF13WBR-20S	136-1010-8	Female														
LF13WBR-11P	136-1011-0	Male	11			19.05										
LF13WBR-11S	136-1012-3	Female				19.05										

Note: Recommended hex nut tightening torque: 1.5 to 2 N·m (3,4,6, and 12 pos.), 2 to 2.5 N·m (11, 20 pos.)

■Receptacles

●Rear panel mount type - Solder Type

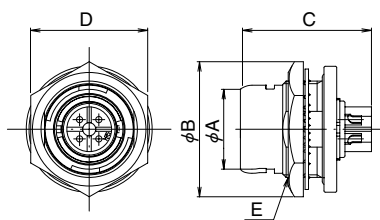

Unit:mm

Part number	CL No.	Contact	Number of contacts	ϕA	ϕB	C	D	E	Weight
LF10WBRB-4P	136-1118-4-00	Male	4	12.8	18.3	19.05	17	M14×0.75	10g
LF10WBRB-12P	136-1013-6-00	Male	12			17.25			
LF10WBRB-12S	136-1014-9-00	Female							

●Rear panel mount type - Through hole Type

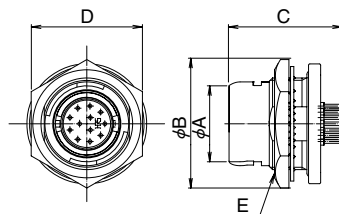

Part number	CL No.	Contact	Number of contacts	ϕA	ϕB	C	D	E	Weight
LF10WBRB-12PD	136-1015-1-00	Male	12	12.8	18.3	17.5	17	M14×0.75	10g
LF10WBRB-12SD	136-1016-4-00	Female							

Unit:mm

■Jacks

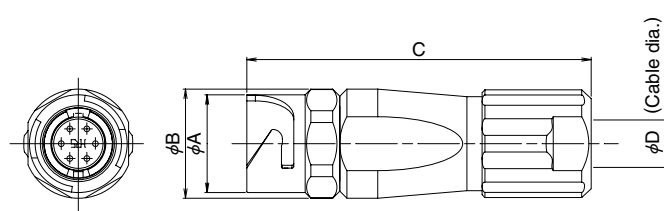
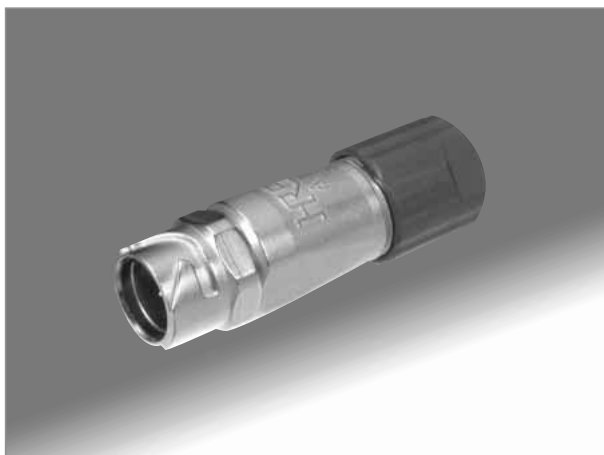

(Shown one example)

Part number	CL No.	Contact	Number of contacts	ϕA	ϕB	C	ϕD	Weight
LF07WBJ-3P	136-2003-8	Male	3	10.3	11.5	36.3	5	11g
LF07WBJ-3S	136-2004-0	Female						
LF07WBJ-6P	136-2001-2	Male	6	12.8	13.8	42.4	7.3	16g
LF07WBJ-6S	136-2002-5	Female						
LF10WBJ-4P	136-2005-3	Male	4	12.8	13.8	42.4	7.3	16g
LF10WBJ-4S	136-2006-6	Female						
LF10WBJ-12P	136-2007-9	Male	12	12.8	13.8	42.4	7.3	16g
LF10WBJ-12S	136-2008-1	Female						
LF13WBJ-20P	136-2009-4	Male	20	15.9	16.9	52.4	8.7	29g
LF13WBJ-20S	136-2010-3	Female						30g
LF13WBJ-11P	136-2011-6	Male	11	15.9	16.9	52.4	8.7	29g
LF13WBJ-11S	136-2012-9	Female						30g

Unit:mm

■CAP

●For Receptacles

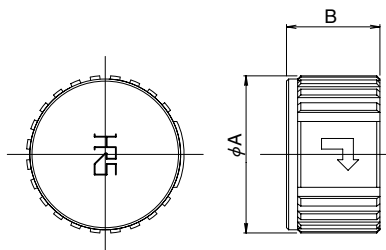

Unit:mm

Part number	CL No.	Applicable connector	φA	B	Weight
LF10WBR-C	136-3001-8-00	LF10EBR-4P	14.8	8.8	5g
		LF10WBR-4S			
		LF10WBR-12P			
		LF10WBR-12S			
		LF10WBRB-4P			
		LF10WBRB-12P			
		LF10WBRB-12S			
		LF10WBRB-12PD			
		LF10WBRB-12SD			
LF13WBR-C	136-3003-3-00	LF13WBR-20P	17.9	8.75	7g
		LF13WBR-20S			
		LF13WBR-11P			
		LF13WBR-11S			

■Applicable tools

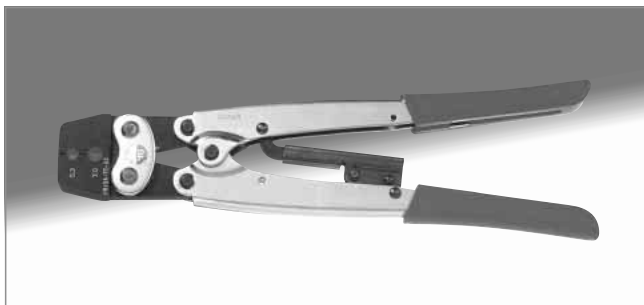

Unit:mm

Description	Part number	CL No.	LF series Applicable cable dia.
Manual cable clamp crimper	HR10A-TC-02	150-0041-2	5 (Note)
	LF-TC-01	150-0234-6	7.3 · 8.7

Note: Applicable cable dia. is only 5mm for LF series.

■Solder termination fixture



(Shown one example)



(Shown one example)

Part number	CL No.	Applicable connectors
LF07BP-T01	150-0232-0	LF07WBP-6S,6P,3S,3P
LF07BJ-T01	150-0233-3	LF07WBJ-6S,6P,3S,3P
LF10BP-T01	150-0235-9	LF10WBP-4S,4P,12S,12P
LF10BJ-T01	150-0236-1	LF10WBJ-4S,4P,12S,12P
LF13BP-T01	150-0237-4	LF13WBP-20S,20P,11S,11P
LF13BJ-T01	150-0238-7	LF13WBJ-20S,20P,11S,11P

■Panel Cutout

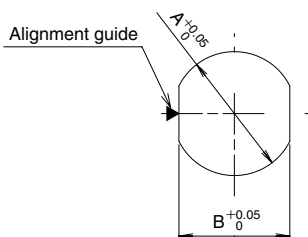

unit (mm)

Shell size	A	B	Panel thickness
LF07WBR-***	φ9.05	8.1	0.7 to 2
LF10WBR-***	φ11.05	10.2	0.7 to 2
LF13WBR-***	φ14.05	13.1	0.7 to 2
LF10WBRB-***	φ14.05	13.1	0.7 to 2

■Contact position arrangement and specifications

Shell size	LF07		LF10		LF13	
Contact configuration						
Number of contacts	3	6	4	12	11	20
Withstanding voltage	1250V AC	300V AC	1250V AC	300V AC	4 AC1250V	7 AC300V
Current rating	5A	2A	10A	2A	4 10A	7 2A
Insulation resistance	1000MΩ		1000MΩ	1000MΩ	1000MΩ	
Contact resistance	15mΩ		5mΩ	15mΩ	4 5mΩ	7 15mΩ
Solder pot inner diameter	1.15mm	0.8mm	1.7mm	0.8mm	4 φ1.7	7 φ0.8

Note 1: The contact configuration as viewed from the female contact connector mating side.

Note 2: The ▼ symbol indicates polarizing key position.

Note 3: Withstanding voltages are test voltage values.

Termination and Assembly Instructions

The connectors are delivered with pre-assembled condition and the disassembly as shown No.1.

No.	Illustration	Operation								
1		<p>Plug disassembly</p> <p>① Insert the plug into securely held solder termination fixture as shown.</p> <table border="1"> <thead> <tr> <th>Fixture Part No.</th> <th>Applicable connector</th> </tr> </thead> <tbody> <tr> <td>LF07BP-T01</td> <td>LF07WBP-6S,6P,3S,3P</td> </tr> <tr> <td>LF10BP-T01</td> <td>LF10WBP-4S,4P,12S,12P</td> </tr> <tr> <td>LF13BP-T01</td> <td>LF13WBP-20S,20P,11S,11P</td> </tr> </tbody> </table>	Fixture Part No.	Applicable connector	LF07BP-T01	LF07WBP-6S,6P,3S,3P	LF10BP-T01	LF10WBP-4S,4P,12S,12P	LF13BP-T01	LF13WBP-20S,20P,11S,11P
	Fixture Part No.	Applicable connector								
	LF07BP-T01	LF07WBP-6S,6P,3S,3P								
	LF10BP-T01	LF10WBP-4S,4P,12S,12P								
LF13BP-T01	LF13WBP-20S,20P,11S,11P									
	<p>② Loosen the backshell turning it counter clockwise and remove it from the body/insulator assembly.</p>									
	<p>Jack Disassembly</p> <p>① Insert the jack into the securely held solder termination fixture as shown.</p> <table border="1"> <thead> <tr> <th>Fixture Part No.</th> <th>Applicable connector</th> </tr> </thead> <tbody> <tr> <td>LF07BJ-T01</td> <td>LF07WBJ-6S,6P,3S,3P</td> </tr> <tr> <td>LF10BJ-T01</td> <td>LF10WBJ-4S,4P,12S,12P</td> </tr> <tr> <td>LF13BJ-T01</td> <td>LF13WBJ-20S,20P,11S,11P</td> </tr> </tbody> </table>	Fixture Part No.	Applicable connector	LF07BJ-T01	LF07WBJ-6S,6P,3S,3P	LF10BJ-T01	LF10WBJ-4S,4P,12S,12P	LF13BJ-T01	LF13WBJ-20S,20P,11S,11P	
Fixture Part No.	Applicable connector									
LF07BJ-T01	LF07WBJ-6S,6P,3S,3P									
LF10BJ-T01	LF10WBJ-4S,4P,12S,12P									
LF13BJ-T01	LF13WBJ-20S,20P,11S,11P									
	<p>② Loosen the backshell turning it counterclockwise.</p>									
2		<p>Connector Assembly</p> <p>① Apply a coating of Loctite 7649 (Manufactured by Henckel Japan, Ltd.) primer to the threaded sections of the backshell and the tightening collar. Completely dry the coated surfaces.</p> <p>Notes</p> <ol style="list-style-type: none"> (1) Drying time at room temperature is approximately 30 to 70 seconds. (2) Ensure sufficient ventilation of the area at time of drying. (3) Take necessary steps to protect the coated surfaces from contamination. 								

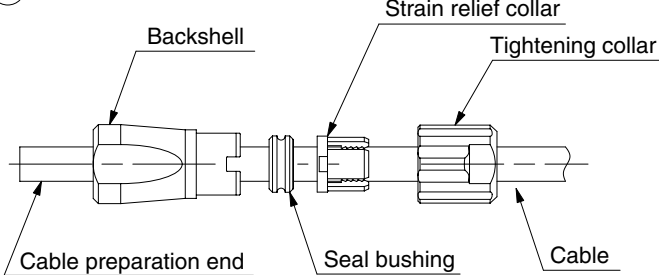
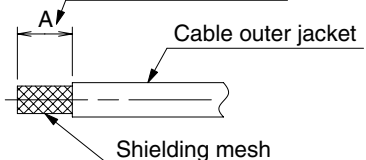
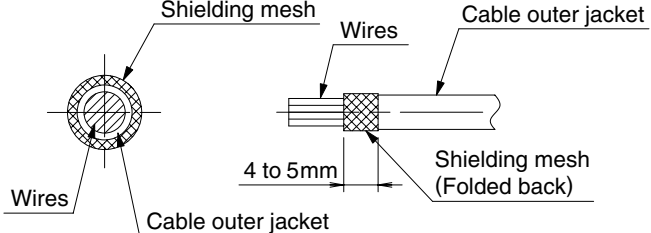
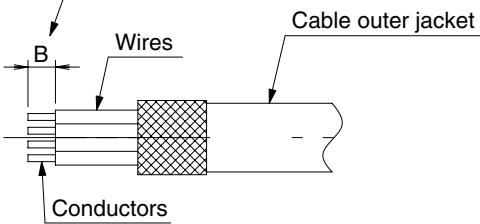
No.	Illustration	Operation														
2	<p>②</p> 	<p>② Thread the tightening collar, strain relief collar, seal bushing and the backshell over the cable as illustrated.</p> <p>Notes Threading the components may not be possible after the cable-end finishing process</p>														
3	<p>①</p> <p>Stripping dimensions</p>  <p>Cable outer jacket</p> <p>Shielding mesh</p> <p>Table 1. Stripping Dimensions</p> <table border="1" data-bbox="446 861 885 1053"> <thead> <tr> <th>Number of Conductors</th> <th>A mm</th> </tr> </thead> <tbody> <tr> <td>3</td> <td rowspan="2">8 to 9</td> </tr> <tr> <td>6</td> </tr> <tr> <td>4</td> <td>13 to 14</td> </tr> <tr> <td>12</td> <td>14 to 15</td> </tr> <tr> <td>11</td> <td>22 to 23 (No.A to D) 23 to 24 (No.1 to 7)</td> </tr> <tr> <td>20</td> <td>23 to 24</td> </tr> </tbody> </table>	Number of Conductors	A mm	3	8 to 9	6	4	13 to 14	12	14 to 15	11	22 to 23 (No.A to D) 23 to 24 (No.1 to 7)	20	23 to 24	<p>Cable preparation</p> <p>① Strip the cable's outer jacket to the dimensions illustrated in the table 1.</p> <p>Notes (1) Exercise caution not to damage the shielding mesh. (2) Any damage to the cable's outer jacket may affect the waterproof performance of the assembled connector.</p>	
Number of Conductors	A mm															
3	8 to 9															
6																
4	13 to 14															
12	14 to 15															
11	22 to 23 (No.A to D) 23 to 24 (No.1 to 7)															
20	23 to 24															
	<p>②</p> 	<p>② Fold back the shielding mesh over the cable's outer jacket assuring that it is uniform on its diameter.</p>														
	<p>③</p> <p>Stripping dimensions</p>  <p>Wires</p> <p>Cable outer jacket</p> <p>Conductors</p> <p>Table 2. Stripping Dimensions</p> <table border="1" data-bbox="446 1776 885 1968"> <thead> <tr> <th>Number of Conductors</th> <th>B mm</th> </tr> </thead> <tbody> <tr> <td>3</td> <td>2.5±0.5</td> </tr> <tr> <td>6</td> <td>2±0.5</td> </tr> <tr> <td>4</td> <td>3±0.5</td> </tr> <tr> <td>12</td> <td>2±0.5</td> </tr> <tr> <td>11</td> <td>3±0.5 (No.A to D) 2±0.5 (No.1 to 7)</td> </tr> <tr> <td>20</td> <td>2±0.5</td> </tr> </tbody> </table>	Number of Conductors	B mm	3	2.5±0.5	6	2±0.5	4	3±0.5	12	2±0.5	11	3±0.5 (No.A to D) 2±0.5 (No.1 to 7)	20	2±0.5	<p>③ Strip the wires to the dimensions illustrated in the Table 2.</p> <p>Notes When stripping the wires exercise caution not to damage it's insulation, folded over shielding mesh or cable's outer jacket. It may cause defects in insulation, conduction, and waterproof performance.</p>
Number of Conductors	B mm															
3	2.5±0.5															
6	2±0.5															
4	3±0.5															
12	2±0.5															
11	3±0.5 (No.A to D) 2±0.5 (No.1 to 7)															
20	2±0.5															

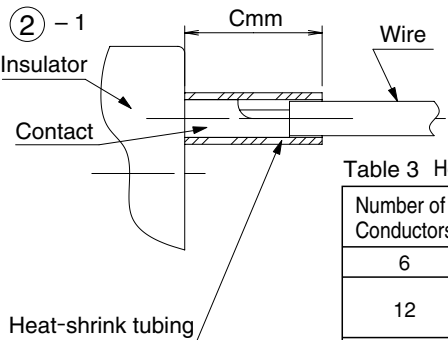
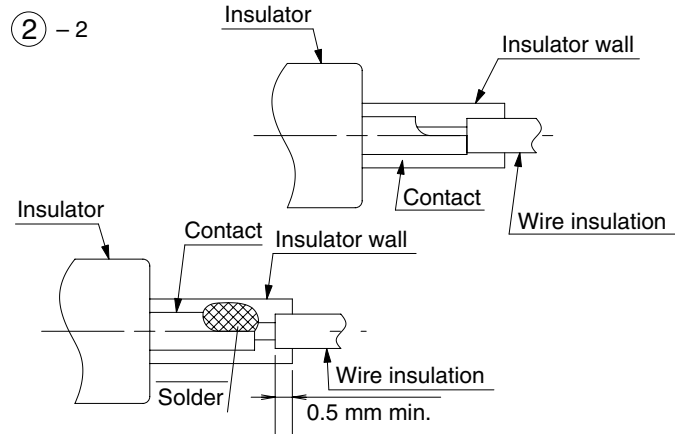
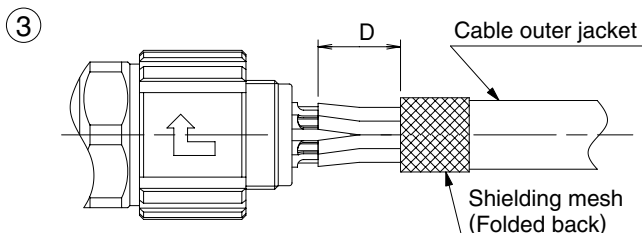
No.	Illustration	Operation																					
4	 <p>② - 1</p> <p>Table 3 Heat shrink tubing Dimensions</p> <table border="1" data-bbox="576 744 933 1021"> <thead> <tr> <th>Number of Conductors</th> <th>Number of contacts</th> <th>C mm</th> </tr> </thead> <tbody> <tr> <td>6</td> <td>1 to 6</td> <td>4</td> </tr> <tr> <td rowspan="2">12</td> <td>1 to 9</td> <td>4</td> </tr> <tr> <td>10 to 12</td> <td>6</td> </tr> <tr> <td rowspan="2">20</td> <td>1 to 5, 16 to 20</td> <td>4</td> </tr> <tr> <td>6 to 15</td> <td>6</td> </tr> <tr> <td rowspan="2">11</td> <td>1 to 4</td> <td>6</td> </tr> <tr> <td>5 to 7</td> <td>4</td> </tr> </tbody> </table>	Number of Conductors	Number of contacts	C mm	6	1 to 6	4	12	1 to 9	4	10 to 12	6	20	1 to 5, 16 to 20	4	6 to 15	6	11	1 to 4	6	5 to 7	4	<p>Soldering</p> <p>① Soldering conditions Soldering iron tip temperature: $350 \pm 10^{\circ}\text{C}$ Soldering time: within 5 sec.</p> <p>Notes</p> <p>(1) Assure that the solder compound is sufficiently melted on the soldering iron tip. (2) When applying, make sure that the solder will flow correctly at all the contact surfaces between the conductor and the contact.</p>
Number of Conductors	Number of contacts	C mm																					
6	1 to 6	4																					
12	1 to 9	4																					
	10 to 12	6																					
20	1 to 5, 16 to 20	4																					
	6 to 15	6																					
11	1 to 4	6																					
	5 to 7	4																					
	 <p>② - 2</p>	<p>② - 1 6, 12, 20, 11(No.1~7) Conductors</p> <p>(1) Place a heat-shrink tubing (inside diameter of 1.1 mm min.) over every other wire. Perform the soldering of the contact and the conductor, with the wire's insulation touching the contact as shown. (2) After soldering, slide the heat shrink tubing over the soldered joint and shrink it. The tubing should touch the insulator as shown. (3) over the soldered joint and shrink it. The tubing should touch the insulator as shown.</p> <p>② - 2 3, 4, 11(No.A~D) Conductors</p> <p>(1) Perform the soldering of the contact and the conductor, with the wire's insulation touching the contact as illustrated. (2) When soldering, to maintain the insulation between adjacent contacts. Make sure that the wire's insulation remains below the edge of the insulator's wall 0.5 mm min., as illustrated.</p>																					
	 <p>③</p> <p>Table 4. Wire Dimensions</p> <table border="1" data-bbox="430 1776 876 1957"> <thead> <tr> <th>Number of Conductors</th> <th>D mm</th> </tr> </thead> <tbody> <tr> <td>3</td> <td rowspan="2">6 to 7</td> </tr> <tr> <td>6</td> </tr> <tr> <td>4</td> <td>10 to 11</td> </tr> <tr> <td>12</td> <td>13 to 14</td> </tr> <tr> <td>11</td> <td rowspan="2">18 to 19</td> </tr> <tr> <td>20</td> </tr> </tbody> </table>	Number of Conductors	D mm	3	6 to 7	6	4	10 to 11	12	13 to 14	11	18 to 19	20	<p>③ After the soldering, keep a distance of D between the contact end and the cable's outer jacket as illustrated.</p> <p>Note</p> <p>The distance of D is required in order to assure correct assembly of the backshell.</p>									
Number of Conductors	D mm																						
3	6 to 7																						
6																							
4	10 to 11																						
12	13 to 14																						
11	18 to 19																						
20																							

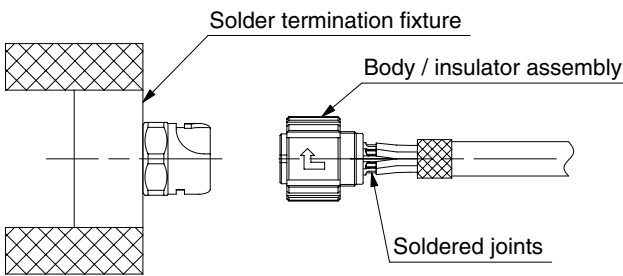
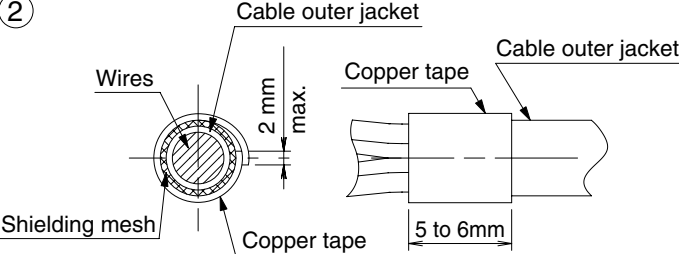
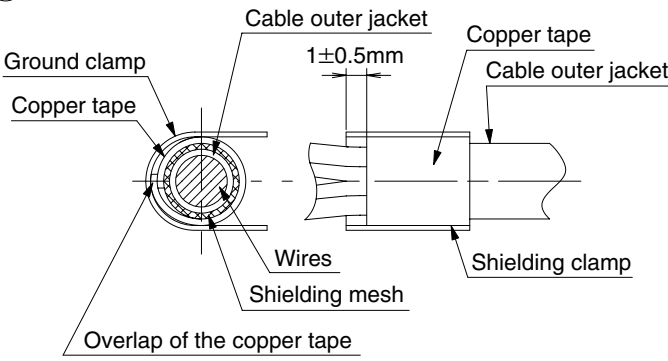
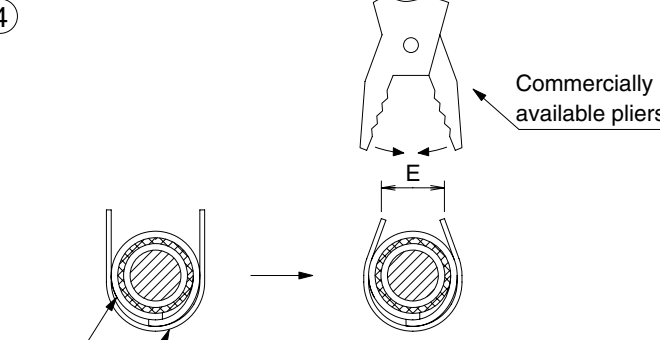
No.	Illustration	Operation							
5	<p>①</p>  <p>Solder termination fixture Body / insulator assembly Soldered joints</p>	<p>Crimping of the Shielding Clamp</p> <p>① After completion of the soldering operations carefully remove (holding on the locking collar) the body/insulator assembly from the solder termination fixture.</p> <p>Note Exercise caution not to damage or deform the solder joints.</p>							
	<p>②</p>  <p>Cable outer jacket Wires Shielding mesh Copper tape 2 mm max. 5 to 6mm</p>	<p>② Wrap the folded over shielding mesh with 5 to 6 mm wide copper tape to assure that it will not become loose. Apply the copper tape so that the shielding mesh does not protrude from under it.</p> <p>Note After wrapping the copper tape, the tape should overlap itself by 2 mm max.</p>							
	<p>③</p>  <p>Ground clamp Copper tape Cable outer jacket 1±0.5mm Copper tape Cable outer jacket Wires Shielding mesh Overlap of the copper tape Shielding clamp</p>	<p>③ Insert the “U” shaped shielding clamp over the copper tape as shown on the illustration. It is critical that the overlap of the copper tape is located inside the shielding clamp as shown on the illustration.</p> <p>Note When the end of the copper tape wrapping is positioned at the open side of the ground fitting, the end portion of the copper tape wrapping will no longer be covered by the ground fitting when the ground fitting is crimped.</p>							
	<p>④</p>  <p>Commercially available pliers E Shielding clamp Overlap of the copper tape</p> <p>Table 5</p> <table border="1" data-bbox="576 1840 909 1968"> <thead> <tr> <th>Shell size</th> <th>E</th> </tr> </thead> <tbody> <tr> <td>LF07</td> <td>5mm max.</td> </tr> <tr> <td>LF10</td> <td rowspan="2">7mm max.</td> </tr> <tr> <td>LF13</td> </tr> </tbody> </table>	Shell size	E	LF07	5mm max.	LF10	7mm max.	LF13	<p>④ Using commercially available pliers bend the open ends of the shielding clamp as illustrated, assuring that it stays in place. The dimension of E. between opposing edges of the shielding clamp is necessary to assure correct final crimp.</p>
Shell size	E								
LF07	5mm max.								
LF10	7mm max.								
LF13									

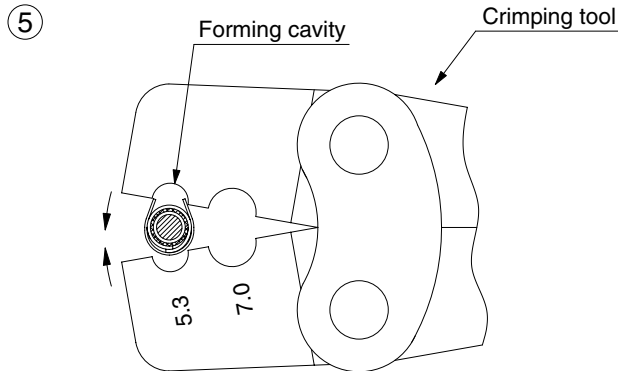
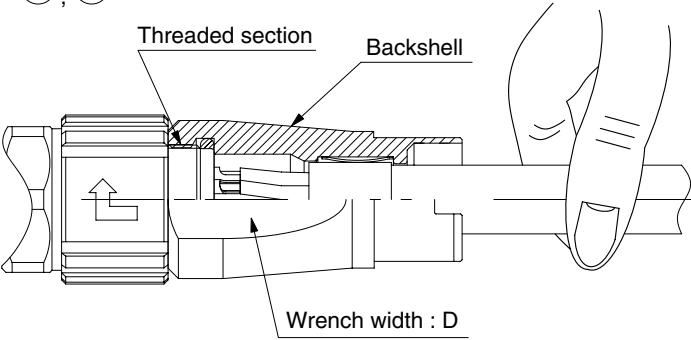
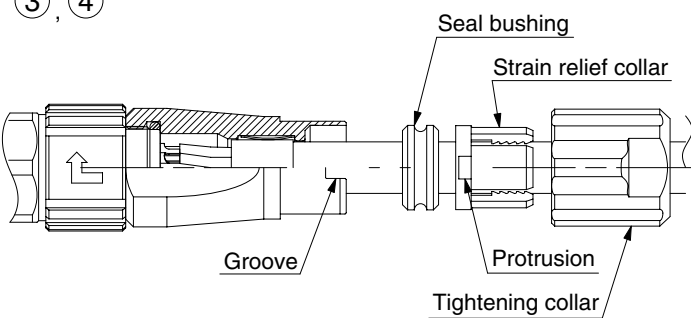
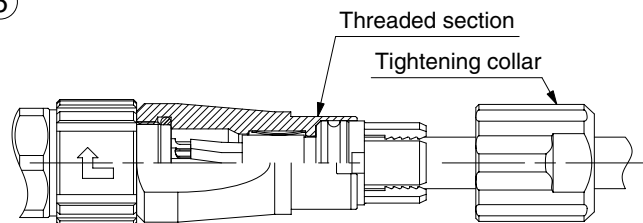
No.	Illustration	Operation																												
5	 <p>⑤</p>	<p>⑤ Both sides of the shielding clamp must be placed in the forming cavity of the tool (as shown on the illustration) and crimped over the cable by closing the tool completely.</p> <table border="1" data-bbox="966 404 1453 563"> <thead> <tr> <th>Crimping tool</th> <th>Forming cavity</th> <th>Applicable cable diameter</th> <th>Shielding clamp diameter after crimping</th> </tr> </thead> <tbody> <tr> <td rowspan="2">HR10A-TC-02</td> <td>5.3</td> <td>5mm</td> <td>5.3mm to 5.5mm</td> </tr> <tr> <td>7.0</td> <td>—</td> <td>—</td> </tr> <tr> <td rowspan="2">LF-TC-01</td> <td>7.9</td> <td>7.3mm</td> <td>7.9mm to 8.1mm</td> </tr> <tr> <td>9.1</td> <td>8.7mm</td> <td>9.1mm to 9.3mm</td> </tr> </tbody> </table>	Crimping tool	Forming cavity	Applicable cable diameter	Shielding clamp diameter after crimping	HR10A-TC-02	5.3	5mm	5.3mm to 5.5mm	7.0	—	—	LF-TC-01	7.9	7.3mm	7.9mm to 8.1mm	9.1	8.7mm	9.1mm to 9.3mm										
Crimping tool	Forming cavity	Applicable cable diameter	Shielding clamp diameter after crimping																											
HR10A-TC-02	5.3	5mm	5.3mm to 5.5mm																											
	7.0	—	—																											
LF-TC-01	7.9	7.3mm	7.9mm to 8.1mm																											
	9.1	8.7mm	9.1mm to 9.3mm																											
6	<p>①, ②</p>  <p>Table 6 (Recommend tightening torque)</p> <table border="1" data-bbox="470 1064 876 1212"> <thead> <tr> <th>Shell size</th> <th>Tightening torque</th> <th>Wrench width</th> </tr> </thead> <tbody> <tr> <td>LF07</td> <td>1N·m~1.5N·m</td> <td>10mm</td> </tr> <tr> <td>LF10</td> <td>1N·m~1.5N·m</td> <td>13mm</td> </tr> <tr> <td>LF13</td> <td>1.5N·m~2N·m</td> <td>16mm</td> </tr> </tbody> </table>	Shell size	Tightening torque	Wrench width	LF07	1N·m~1.5N·m	10mm	LF10	1N·m~1.5N·m	13mm	LF13	1.5N·m~2N·m	16mm	<h3>Connector Assembly</h3> <p>① Place the body/insulator assembly in the applicable solder termination fixture.</p> <p>For plug assembly</p> <table border="1" data-bbox="998 766 1372 861"> <thead> <tr> <th>Fixture Part No.</th> <th>Applicable connector</th> </tr> </thead> <tbody> <tr> <td>LF07BP-T01</td> <td>LF07WBP-6S,6P,3S,3P</td> </tr> <tr> <td>LF10BP-T01</td> <td>LF10WBP-4S,4P,12S,12P</td> </tr> <tr> <td>LF13BP-T01</td> <td>LF13WBP-20S,20P,11S,11P</td> </tr> </tbody> </table> <p>For jack assembly</p> <table border="1" data-bbox="998 883 1372 978"> <thead> <tr> <th>Fixture Part No.</th> <th>Applicable connector</th> </tr> </thead> <tbody> <tr> <td>LF07BJ-T01</td> <td>LF07WBJ-6S,6P,3S,3P</td> </tr> <tr> <td>LF10BJ-T01</td> <td>LF10WBJ-4S,4P,12S,12P</td> </tr> <tr> <td>LF13BJ-T01</td> <td>LF13WBJ-20S,20P,11S,11P</td> </tr> </tbody> </table> <p>② Coat the thread section of the body/insulator assembly with Loctite 271 compound (manufactured by Henckel Japan, Ltd.) or equivalent, tightening it with a torque specified in the table 6.</p> <p>Note It is critical that the cable itself will not turn or twist during this operation. It may cause breakage at the soldered area.</p>	Fixture Part No.	Applicable connector	LF07BP-T01	LF07WBP-6S,6P,3S,3P	LF10BP-T01	LF10WBP-4S,4P,12S,12P	LF13BP-T01	LF13WBP-20S,20P,11S,11P	Fixture Part No.	Applicable connector	LF07BJ-T01	LF07WBJ-6S,6P,3S,3P	LF10BJ-T01	LF10WBJ-4S,4P,12S,12P	LF13BJ-T01	LF13WBJ-20S,20P,11S,11P
Shell size	Tightening torque	Wrench width																												
LF07	1N·m~1.5N·m	10mm																												
LF10	1N·m~1.5N·m	13mm																												
LF13	1.5N·m~2N·m	16mm																												
Fixture Part No.	Applicable connector																													
LF07BP-T01	LF07WBP-6S,6P,3S,3P																													
LF10BP-T01	LF10WBP-4S,4P,12S,12P																													
LF13BP-T01	LF13WBP-20S,20P,11S,11P																													
Fixture Part No.	Applicable connector																													
LF07BJ-T01	LF07WBJ-6S,6P,3S,3P																													
LF10BJ-T01	LF10WBJ-4S,4P,12S,12P																													
LF13BJ-T01	LF13WBJ-20S,20P,11S,11P																													
	<p>③, ④</p> 	<p>③ Slide forward the seal bushing and insert it in the backshell until fully seated.</p> <p>④ Slide forward the strain relief collar and insert it in the backshell, making sure that the opposing protrusions fit inside the corresponding grooves, as shown on the illustration.</p> <p>Note It is critical that the protrusions are inside the corresponding grooves. It may cause breakage, when a tightening collar is assembled.</p>																												
	<p>⑤</p> 	<p>⑤ Verify that the Loctite 7649 primer (or equivalent) on the threaded sections of the backshell and tightening collar are dry. Apply the Loctite 271 compound to the tightening collar's threaded section and attach it to the backshell.</p>																												

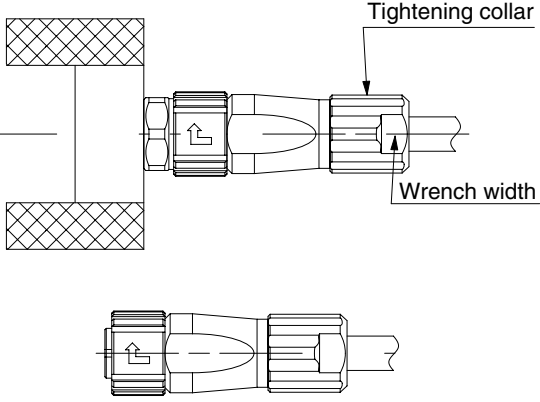
No.	Illustration	Operation												
6		<p>⑥ Remove the connector from the solder termination fixture, holding it by the locking collar. Do not pull on the cable. It may cause breakage.</p> <p style="text-align: center;">Recommended tightening torque</p> <table border="1" data-bbox="946 410 1354 534"> <thead> <tr> <th>Shell size</th> <th>Tightening torque</th> <th>Wrench width</th> </tr> </thead> <tbody> <tr> <td>LF07</td> <td>0.8N·m~1N·m</td> <td>10mm</td> </tr> <tr> <td>LF10</td> <td>0.7N·m~1N·m</td> <td>13mm</td> </tr> <tr> <td>LF13</td> <td>1 N·m~1.5 N·m</td> <td>16mm</td> </tr> </tbody> </table>	Shell size	Tightening torque	Wrench width	LF07	0.8N·m~1N·m	10mm	LF10	0.7N·m~1N·m	13mm	LF13	1 N·m~1.5 N·m	16mm
Shell size	Tightening torque	Wrench width												
LF07	0.8N·m~1N·m	10mm												
LF10	0.7N·m~1N·m	13mm												
LF13	1 N·m~1.5 N·m	16mm												

1. To maintain the water/dust protection performance and the cable clamp force, use a cable that is within the range of applicable diameter.
2. Consult HRS representative when using different cables.

■ Cable Specifications (Reference)

No. of contact		3 pos.	4 pos.	6 pos.	12 pos.	20 pos.	11 pos.	
Conductor	Material	Soft copper wire	Soft copper wire	Soft copper wire	Soft copper wire	Soft copper wire	Soft copper wire	Soft copper wire
	Size (mm)	φ0.18	φ0.26	φ0.16	φ0.16	φ0.16	φ0.26	φ0.16
	Construction	20 / φ0.18 mm dia.	20 / φ0.26 mm dia.	7 / φ0.16 mm dia.	7 / φ0.16 mm dia.	7 / φ0.16 mm dia.	26 / φ0.26 mm dia.	7 / φ0.16 mm dia.
	Size (AWG)	AWG #20	AWG #16	AWG #26	AWG #26	AWG #26	AWG #16	AWG #26
	Sectional area	0.5	1.25	0.14	0.14	0.14	1.25	0.14
	Diameter (mm)	φ0.98	φ1.5	φ0.48	φ0.48	φ0.48	φ1.5	φ0.48
Insulator	Diameter (mm)	φ1.5 (Standard)	φ2.1 (Standard)	φ0.88 (Standard)	φ0.9 (Standard)	φ0.9 (Standard)	φ2.1 (Standard)	φ0.95 (Standard)
	Thickness (mm)	0.26	0.3	0.2	0.21	0.21	0.3	0.24
Shield	Material	Soft copper wire	Soft copper wire	Soft copper wire	Soft copper wire	Soft copper wire	Soft copper wire	
	Density	85%	80%	85%	80%	80%	80%	
	Diameter (mm)	φ3.6	φ5.5	φ3.4	φ4.2	φ5.1	φ6.7	
Jacket	Diameter (mm)	φ5±0.2	φ7.3±0.2	φ5±0.2	φ7.3±0.2	φ8.7±0.2	φ8.7±0.2	

NOTES :

Dotted lines for note entry.

- USA:**
HIROSE ELECTRIC (U.S.A.), INC. Headquarters
2688 Westhills Court, Simi Valley, CA 93065-6235
Phone : 1-805-522-7958
Fax : 1-805-522-3217
<http://www.hiroseusa.com>
- USA:**
HIROSE ELECTRIC (U.S.A.), INC. North California Office
20400 Stevens Creek Blvd., Ste 250, Cupertino, CA 95014
Phone : 1-408-253-9640
Fax : 1-408-253-9641
<http://www.hiroseusa.com>
- USA:**
HIROSE ELECTRIC (U.S.A.), INC. Detroit Office (Automotive)
37677 Professional Center Drive, Suite #100C Livonia, MI 48154
Phone : 1-734-542-9963
Fax : 1-734-542-9964
<http://www.hiroseusa.com>
- GERMANY:**
HIROSE ELECTRIC EUROPE B.V. GERMAN BRANCH
Herzog-Carl-Strasse 4 D-73760 Ostfildern (Scharnhauser Park)
Phone : 49-711-4560-02-1
Fax : 49-711-4560-02-299
<http://www.hirose.de>
- THE NETHERLANDS:**
HIROSE ELECTRIC EUROPE B.V.
Hogehillweg #8 1101 CC Amsterdam Z-0
Phone : 31-20-6557460
Fax : 31-20-6557469
<http://www.hiroseeurope.com>
- UK:**
HIROSE ELECTRIC EUROPE B.V. UK BRANCH
First Floor, St Andrews House, Caldecotte Lake Business Park, Milton Keynes MK7 8LE
Phone : 44-1908-369060
Fax : 44-1908-369078
<http://www.hirose.co.uk>
- CHINA:**
HIROSE ELECTRIC (SHANGHAI) CO., LTD. BEIJING BRANCH
A1001, Ocean International Center, Building 56# East 4th Ring Middle Road, Chao Yang District, Beijing, 100025
Phone : 86-10-5165-9332
Fax : 86-10-5908-1381
<http://www.hirose-china.com.cn>
- CHINA:**
HIROSE ELECTRIC (SHANGHAI) CO., LTD.
1601, Henderson Metropolitan, NO.300 ,East Nanjing Road, Huangpu District, Shanghai, China 200001
Phone : 86-21-6391-3355
Fax : 86-21-6391-3335
<http://www.hirose-china.com.cn>
- CHINA:**
HIROSE ELECTRIC TECHNOLOGIES (SHENZHEN) CO., LTD.
Room 09-13, 19/F, Office Tower Shun Hing Square, Di Wang Commercial Centre 5002, ShenNanDong Road, ShenZhen City, Guangdong Province, 518008
Phone : 86-755-8207-0851
Fax : 86-755-8207-0873
<http://www.hirose-china.com.cn>
- HONG KONG:**
HIROSE ELECTRIC HONGKONG TRADING CO., LTD.
Room 1001, West Wing, Tsim Sha Tsui Centre, 66 Mody Road, Tsim Sha Tsui East, Kowloon, Hong Kong
Phone : 852-2803-5338
Fax : 852-2591-6560
<http://www.hirose-hongkong.com.hk>
- TAIWAN:**
HIROSE ELECTRIC TAIWAN CO., LTD.
103 8F, No.87, Zhengzhou Rd., Taipei
Phone : 886-2-2555-7377
Fax : 886-2-2555-7350
<http://www.hirose-taiwan.com.tw>
- SINGAPORE:**
HIROSE ELECTRIC SINGAPORE PTE. LTD.
10 Anson Road #26-16 International Plaza 079903
Phone : 65-6324-6113
Fax : 65-6324-6123
<http://www.hirose-singapore.com.sg>
- KOREA:**
HIROSE KOREA CO., LTD.
1261-10, Jeoungwhang-Dong, Shihung-City, Kyunggi-Do 429-450
Phone : 82-31-496-7000,7124
Fax : 82-31-496-7100
<http://www.hirose.co.kr>



HIROSE ELECTRIC CO.,LTD.

5-23, OSAKI 5-CHOME, SHINAGAWA-KU, TOKYO 141-8587, JAPAN
PHONE: 81-3-3491-5300, FAX: 81-3-3495-5230
<http://www.hirose.com>
<http://www.hirose-connectors.com>

Компания «Океан Электроники» предлагает заключение долгосрочных отношений при поставках импортных электронных компонентов на взаимовыгодных условиях!

Наши преимущества:

- Поставка оригинальных импортных электронных компонентов напрямую с производств Америки, Европы и Азии, а так же с крупнейших складов мира;
- Широкая линейка поставок активных и пассивных импортных электронных компонентов (более 30 млн. наименований);
- Поставка сложных, дефицитных, либо снятых с производства позиций;
- Оперативные сроки поставки под заказ (от 5 рабочих дней);
- Экспресс доставка в любую точку России;
- Помощь Конструкторского Отдела и консультации квалифицированных инженеров;
- Техническая поддержка проекта, помощь в подборе аналогов, поставка прототипов;
- Поставка электронных компонентов под контролем ВП;
- Система менеджмента качества сертифицирована по Международному стандарту ISO 9001;
- При необходимости вся продукция военного и аэрокосмического назначения проходит испытания и сертификацию в лаборатории (по согласованию с заказчиком);
- Поставка специализированных компонентов военного и аэрокосмического уровня качества (Xilinx, Altera, Analog Devices, Intersil, Interpoint, Microsemi, Actel, Aeroflex, Peregrine, VPT, Syfer, Eurofarad, Texas Instruments, MS Kennedy, Miteq, Cobham, E2V, MA-COM, Hittite, Mini-Circuits, General Dynamics и др.);

Компания «Океан Электроники» является официальным дистрибьютором и эксклюзивным представителем в России одного из крупнейших производителей разъемов военного и аэрокосмического назначения «JONHON», а так же официальным дистрибьютором и эксклюзивным представителем в России производителя высокотехнологичных и надежных решений для передачи СВЧ сигналов «FORSTAR».



JONHON

«JONHON» (основан в 1970 г.)

Разъемы специального, военного и аэрокосмического назначения:

(Применяются в военной, авиационной, аэрокосмической, морской, железнодорожной, горно- и нефтедобывающей отраслях промышленности)

«FORSTAR» (основан в 1998 г.)

ВЧ соединители, коаксиальные кабели, кабельные сборки и микроволновые компоненты:

(Применяются в телекоммуникациях гражданского и специального назначения, в средствах связи, РЛС, а так же военной, авиационной и аэрокосмической отраслях промышленности).



Телефон: 8 (812) 309-75-97 (многоканальный)

Факс: 8 (812) 320-03-32

Электронная почта: ocean@oceanchips.ru

Web: <http://oceanchips.ru/>

Адрес: 198099, г. Санкт-Петербург, ул. Калинина, д. 2, корп. 4, лит. А