



FEATURES

- SNR = 70.6 dBFS at 185 MHz A_{IN} and 250 MSPS
- SFDR = 85 dBc at 185 MHz A_{IN} and 250 MSPS
- 151.6 dBFS/Hz input noise at 185 MHz, -1 dBFS A_{IN} and 250 MSPS
- Total power consumption: 785 mW at 250 MSPS
- 1.8 V supply voltages
- LVDS (ANSI-644 levels) outputs
- Integer 1-to-8 input clock divider (625 MHz maximum input)
- Sample rates of up to 250 MSPS
- IF sampling frequencies of up to 400 MHz
- Internal ADC voltage reference
- Flexible analog input range
 - 1.4 V p-p to 2.0 V p-p (1.75 V p-p nominal)
- ADC clock duty cycle stabilizer
- 95 dB channel isolation/crosstalk
- Serial port control
- Energy saving power-down modes

APPLICATIONS

- Communications
 - Diversity radio systems
 - Multimode digital receivers (3G)
 - TD-SCDMA, WiMax, WCDMA, CDMA2000, GSM, EDGE, LTE
 - I/Q demodulation systems
 - Smart antenna systems
- General-purpose software radios
- Ultrasound equipment
- Broadband data applications

GENERAL DESCRIPTION

The AD9643 is a dual, 14-bit analog-to-digital converter (ADC) with sampling speeds of up to 250 MSPS. The AD9643 is designed to support communications applications, where low cost, small size, wide bandwidth, and versatility are desired.

The dual ADC cores feature a multistage, differential pipelined architecture with integrated output error correction logic. Each ADC features wide bandwidth inputs supporting a variety of user-selectable input ranges. An integrated voltage reference eases design considerations. A duty cycle stabilizer is provided to compensate for variations in the ADC clock duty cycle, allowing the converters to maintain excellent performance.

The ADC output data is routed directly to the external, 14-bit, LVDS output port and formatted as either interleaved or channel multiplexed.

Flexible power-down options allow significant power savings, when desired.

Rev. F

[Document Feedback](#)

Information furnished by Analog Devices is believed to be accurate and reliable. However, no responsibility is assumed by Analog Devices for its use, nor for any infringements of patents or other rights of third parties that may result from its use. Specifications subject to change without notice. No license is granted by implication or otherwise under any patent or patent rights of Analog Devices. Trademarks and registered trademarks are the property of their respective owners.

FUNCTIONAL BLOCK DIAGRAM

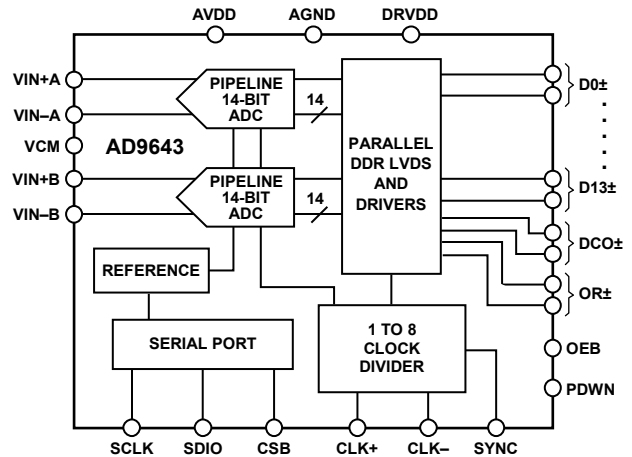

NOTES
1. THE D0± TO D13± PINS REPRESENT BOTH THE CHANNEL A AND CHANNEL B LVDS OUTPUT DATA.

Figure 1.

08636-001

Programming for setup and control are accomplished using a 3-wire SPI-compatible serial interface.

The AD9643 is available in a 64-lead LFCSP and is specified over the industrial temperature range of -40°C to +85°C. This product is protected by a U.S. patent.

PRODUCT HIGHLIGHTS

1. Integrated dual, 14-bit, 170 MSPS/210 MSPS/250 MSPS ADCs.
2. Operation from a single 1.8 V supply and a separate digital output driver supply accommodating LVDS outputs.
3. Proprietary differential input maintains excellent SNR performance for input frequencies of up to 400 MHz.
4. SYNC input allows synchronization of multiple devices.
5. 3-pin, 1.8 V SPI port for register programming and register readback.
6. Pin compatibility with the AD9613, allowing a simple migration down from 14 bits to 12 bits. This part is also pin compatible with the AD6649 and the AD6643.

TABLE OF CONTENTS

| | | | |
|--|----|---|----|
| Features | 1 | Analog Input Considerations | 23 |
| Applications | 1 | Voltage Reference | 25 |
| Functional Block Diagram | 1 | Clock Input Considerations | 25 |
| General Description | 1 | Power Dissipation and Standby Mode | 26 |
| Product Highlights | 1 | Digital Outputs | 27 |
| Revision History | 2 | ADC Overrange (OR) | 27 |
| Specifications | 3 | Channel/Chip Synchronization | 28 |
| ADC DC Specifications | 3 | Serial Port Interface (SPI) | 29 |
| ADC AC Specifications | 4 | Configuration Using the SPI | 29 |
| Digital Specifications | 6 | Hardware Interface | 29 |
| Switching Specifications | 8 | SPI Accessible Features | 30 |
| Timing Specifications | 9 | Memory Map | 31 |
| Absolute Maximum Ratings | 11 | Reading the Memory Map Register Table | 31 |
| Thermal Characteristics | 11 | Memory Map Register Table | 32 |
| ESD Caution | 11 | Memory Map Register Description | 34 |
| Pin Configurations and Function Descriptions | 12 | Applications Information | 35 |
| Typical Performance Characteristics | 16 | Design Guidelines | 35 |
| Equivalent Circuits | 22 | Outline Dimensions | 36 |
| Theory of Operation | 23 | Ordering Guide | 36 |
| ADC Architecture | 23 | | |

REVISION HISTORY

4/2019—Rev. E to Rev. F

| | |
|--|----|
| Changes to General Description Section | 1 |
| Changes to Ordering Guide | 36 |

1/2014—Rev. D to Rev. E

| | |
|----------------------------|----|
| Changes to Figure 32 | 29 |
|----------------------------|----|

2/2013—Rev. C to Rev. D

| | |
|--|---|
| Added t_{SSYNC} and t_{HSYNC} Minimum Parameters of 1 ns, Table 5 .. | 9 |
|--|---|

1/2013—Rev. B to Rev. C

| | |
|---|----|
| Changes to Features Section | 1 |
| Changes to Input Referred Noise Parameter, Table 1 | 3 |
| Changes to Table 2 | 4 |
| Change to Table 3 | 6 |
| Changes to Table 4 | 8 |
| Changes to Figure 5 | 14 |
| Changes to Figure 29 | 19 |
| Changes to Figure 30 | 20 |
| Change to Reading the Memory Map Register Table Section | 31 |
| Changes to Table 14 | 33 |
| Change to Memory Map Register Description Section | 34 |
| Updated Outline Dimensions | 36 |

9/2011—Rev. A to Rev. B

| | |
|--|----|
| Changes to Table 1 | 3 |
| Changes to Table 2, | 4 |
| Changes to Table 3 | 6 |
| Changes to Table 4 | 8 |
| Changes to Table 8 | 12 |
| Changes to Table 9 | 14 |
| Changes to Typical Performance Characteristics Section | 16 |
| Added ADC Overrange (OR) Section | 27 |
| Changes to Channel/Chip Synchronization Section | 28 |
| Changes to Reading the Memory Map Register Table Section | 31 |
| Changes to Table 14 | 32 |
| Changes to Memory Map Register Description Section | 34 |

5/2011—Rev. 0 to Rev. A

| | |
|---|---|
| Changes to Table 2, Worst Other (Harmonic or Spur) Max Values | 4 |
|---|---|

4/2011—Revision 0: Initial Version

SPECIFICATIONS

ADC DC SPECIFICATIONS

AVDD = 1.8 V, DRVDD = 1.8 V, maximum sample rate, VIN = -1.0 dBFS differential input, 1.75 V p-p full-scale input range, duty cycle stabilizer (DCS) enabled, unless otherwise noted.

Table 1.

| Parameter | Temperature | AD9643-170 | | | AD9643-210 | | | AD9643-250 | | | Unit |
|--|-------------|---------------|-----|-----|-------------|-----|-----|---------------|-----|-----|---------|
| | | Min | Typ | Max | Min | Typ | Max | Min | Typ | Max | |
| RESOLUTION | Full | 14 | | | 14 | | | 14 | | | Bits |
| ACCURACY | | Guaranteed | | | Guaranteed | | | Guaranteed | | | |
| No Missing Codes | Full | Guaranteed | | | Guaranteed | | | Guaranteed | | | |
| Offset Error | Full | ±10 | | | ±10 | | | ±10 | | | mV |
| Gain Error | Full | +2/-6 | | | +3/-5 | | | ±4 | | | %FSR |
| Differential Nonlinearity (DNL) | Full | ±0.75 | | | ±0.75 | | | ±0.75 | | | LSB |
| | 25°C | ±0.25 | | | ±0.25 | | | ±0.25 | | | LSB |
| Integral Nonlinearity (INL) ¹ | Full | ±1.8 | | | ±2 | | | ±3.5 | | | LSB |
| | 25°C | ±1.5 | | | ±1.5 | | | ±1.5 | | | LSB |
| MATCHING CHARACTERISTIC | | | | | | | | | | | |
| Offset Error | Full | ±13 | | | ±13 | | | ±13 | | | mV |
| Gain Error | Full | ±2.5/ +3.5 | | | -2/ +3.5 | | | -2.5/ +3.5 | | | %FSR |
| TEMPERATURE DRIFT | | | | | | | | | | | |
| Offset Error | Full | ±5 | | | ±5 | | | ±5 | | | ppm/°C |
| Gain Error | Full | ±70 | | | ±80 | | | ±100 | | | ppm/°C |
| INPUT REFERRED NOISE | | | | | | | | | | | |
| VREF = 1.75 V | 25°C | 1.33 | | | 1.33 | | | 1.33 | | | LSB rms |
| ANALOG INPUT | | | | | | | | | | | |
| Input Span | Full | 1.75 | | | 1.75 | | | 1.75 | | | V p-p |
| Input Capacitance ² | Full | 2.5 | | | 2.5 | | | 2.5 | | | pF |
| Input Resistance ³ | Full | 20 | | | 20 | | | 20 | | | kΩ |
| Input Common-Mode Voltage | Full | 0.9 | | | 0.9 | | | 0.9 | | | V |
| POWER SUPPLIES | | | | | | | | | | | |
| Supply Voltage | | | | | | | | | | | |
| AVDD | Full | 1.7 | 1.8 | 1.9 | 1.7 | 1.8 | 1.9 | 1.7 | 1.8 | 1.9 | V |
| DRVDD | Full | 1.7 | 1.8 | 1.9 | 1.7 | 1.8 | 1.9 | 1.7 | 1.8 | 1.9 | V |
| Supply Current | | | | | | | | | | | |
| I _{AVDD1} | Full | | 196 | 250 | | 217 | 265 | | 256 | 275 | mA |
| I _{DRVDD1} | Full | | 145 | 160 | | 160 | 185 | | 180 | 210 | mA |
| POWER CONSUMPTION | | | | | | | | | | | |
| Sine Wave Input (DRVDD = 1.8 V) | Full | 614 | | | 680 | | | 785 | | | mW |
| Standby Power ⁴ | Full | 90 | | | 90 | | | 90 | | | mW |
| Power-Down Power | Full | 10 | | | 10 | | | 10 | | | mW |

¹ Measured with a low input frequency, full-scale sine wave.

² Input capacitance refers to the effective capacitance between one differential input pin and its complement.

³ Input resistance refers to the effective resistance between one differential input pin and its complement.

⁴ Standby power is measured with a dc input and the CLK pin inactive (that is, set to AVDD or AGND).

ADC AC SPECIFICATIONS

AVDD = 1.8 V, DRVDD = 1.8 V, maximum sample rate, VIN = -1.0 dBFS differential input, 1.75 V p-p full-scale input range, unless otherwise noted.

Table 2.

| Parameter ¹ | Temperature | AD9643-170 | | | AD9643-210 | | | AD9643-250 | | | Unit |
|--|-------------|------------|------|-----|------------|------|-----|------------|------|-----|------|
| | | Min | Typ | Max | Min | Typ | Max | Min | Typ | Max | |
| SIGNAL-TO-NOISE-RATIO (SNR) | | | | | | | | | | | |
| f _{IN} = 30 MHz | 25°C | | 72.6 | | | 72.6 | | | 72.0 | | dBFS |
| f _{IN} = 90 MHz | 25°C | | 72.2 | | | 72.2 | | | 71.6 | | dBFS |
| | Full | 70.8 | | | 70.6 | | | | | | dBFS |
| f _{IN} = 140 MHz | 25°C | | 71.8 | | | 71.3 | | | 71.2 | | dBFS |
| f _{IN} = 185 MHz | 25°C | | 71.2 | | | 70.6 | | | 70.6 | | dBFS |
| | Full | | | | | | | 68.8 | | | dBFS |
| f _{IN} = 220 MHz | 25°C | | 70.7 | | | 69.9 | | | 69.9 | | dBFS |
| SIGNAL-TO-NOISE AND DISTORTION (SINAD) | | | | | | | | | | | |
| f _{IN} = 30 MHz | 25°C | | 71.6 | | | 71.5 | | | 70.9 | | dBFS |
| f _{IN} = 90 MHz | 25°C | | 71.1 | | | 71.2 | | | 70.5 | | dBFS |
| | Full | 70.4 | | | 69.9 | | | | | | dBFS |
| f _{IN} = 140 MHz | 25°C | | 70.5 | | | 70.1 | | | 69.9 | | dBFS |
| f _{IN} = 185 MHz | 25°C | | 69.6 | | | 69.2 | | | 69.4 | | dBFS |
| | Full | | | | | | | 67.5 | | | dBFS |
| f _{IN} = 220 MHz | 25°C | | 69.1 | | | 68.1 | | | 68.8 | | dBFS |
| EFFECTIVE NUMBER OF BITS (ENOB) | | | | | | | | | | | |
| f _{IN} = 30 MHz | 25°C | | 11.6 | | | 11.6 | | | 11.5 | | Bits |
| f _{IN} = 90 MHz | 25°C | | 11.5 | | | 11.5 | | | 11.4 | | Bits |
| f _{IN} = 140 MHz | 25°C | | 11.4 | | | 11.4 | | | 11.3 | | Bits |
| f _{IN} = 185 MHz | 25°C | | 11.3 | | | 11.2 | | | 11.2 | | Bits |
| f _{IN} = 220 MHz | 25°C | | 11.2 | | | 11.0 | | | 11.1 | | Bits |
| WORST SECOND OR THIRD HARMONIC | | | | | | | | | | | |
| f _{IN} = 30 MHz | 25°C | | -95 | | | -90 | | | -90 | | dBc |
| f _{IN} = 90 MHz | 25°C | | -92 | | | -90 | | | -88 | | dBc |
| | Full | | | -78 | | | -80 | | | | dBc |
| f _{IN} = 140 MHz | 25°C | | -88 | | | -88 | | | -86 | | dBc |
| f _{IN} = 185 MHz | 25°C | | -83 | | | -87 | | | -85 | | dBc |
| | Full | | | | | | | | | -80 | dBc |
| f _{IN} = 220 MHz | 25°C | | -83 | | | -85 | | | -85 | | dBc |
| SPURIOUS-FREE DYNAMIC RANGE (SFDR) | | | | | | | | | | | |
| f _{IN} = 30 MHz | 25°C | | 95 | | | 90 | | | 90 | | dBc |
| f _{IN} = 90 MHz | 25°C | | 92 | | | 90 | | | 88 | | dBc |
| | Full | 78 | | | 80 | | | | | | dBc |
| f _{IN} = 140 MHz | 25°C | | 88 | | | 88 | | | 86 | | dBc |
| f _{IN} = 185 MHz | 25°C | | 83 | | | 87 | | | 85 | | dBc |
| | Full | | | | | | | 80 | | | dBc |
| f _{IN} = 220 MHz | 25°C | | 83 | | | 85 | | | 85 | | dBc |
| WORST OTHER (HARMONIC OR SPUR) | | | | | | | | | | | |
| f _{IN} = 30 MHz | 25°C | | -98 | | | -95 | | | -94 | | dBc |
| f _{IN} = 90 MHz | 25°C | | -97 | | | -95 | | | -93 | | dBc |
| | Full | | | -78 | | | -80 | | | | dBc |
| f _{IN} = 140 MHz | 25°C | | -97 | | | -93 | | | -92 | | dBc |
| f _{IN} = 185 MHz | 25°C | | -96 | | | -92 | | | -92 | | dBc |
| | Full | | | | | | | | | -80 | dBc |
| f _{IN} = 220 MHz | 25°C | | -94 | | | -90 | | | -88 | | dBc |

| Parameter ¹ | Temperature | AD9643-170 | | | AD9643-210 | | | AD9643-250 | | | Unit |
|--|-------------|------------|------|-----|------------|------|-----|------------|------|-----|------|
| | | Min | Typ | Max | Min | Typ | Max | Min | Typ | Max | |
| TWO-TONE SFDR $f_{IN} = 184.12 \text{ MHz} (-7 \text{ dBFS}), 187.12 \text{ MHz} (-7 \text{ dBFS})$ | 25°C | | 88 | | | 88 | | | 88 | | dBc |
| CROSSTALK ² | Full | | 95 | | | 95 | | | 95 | | dB |
| FULL POWER BANDWIDTH ³ | 25°C | | 1000 | | | 1000 | | | 1000 | | MHz |

¹ See the [AN-835 Application Note, *Understanding High Speed ADC Testing and Evaluation*](#), for a complete set of definitions.

² Crosstalk is measured at 100 MHz with -1.0 dBFS on one channel and no input on the alternate channel.

³ Full power bandwidth is the bandwidth of operation in which proper ADC performance can be achieved.

DIGITAL SPECIFICATIONS

AVDD = 1.8 V, DRVDD = 1.8 V, maximum sample rate, VIN = -1.0 dBFS differential input, 1.75 V p-p full-scale input range, DCS enabled, unless otherwise noted.

Table 3.

| Parameter | Temp | Min | Typ | Max | Unit |
|---|------|------------------|-----|------|-------|
| DIFFERENTIAL CLOCK INPUTS (CLK+, CLK-) | | | | | |
| Logic Compliance | | CMOS/LVDS/LVPECL | | | |
| Internal Common-Mode Bias | Full | | 0.9 | | V |
| Differential Input Voltage | Full | 0.3 | | 3.6 | V p-p |
| Input Voltage Range | Full | AGND | | AVDD | V |
| Input Common-Mode Range | Full | 0.9 | | 1.4 | V |
| High Level Input Current | Full | -10 | | +22 | μA |
| Low Level Input Current | Full | -22 | | -10 | μA |
| Input Capacitance | Full | | 4 | | pF |
| Input Resistance | Full | 8 | 10 | 12 | kΩ |
| SYNC INPUT | | | | | |
| Logic Compliance | | CMOS/LVDS | | | |
| Internal Bias | Full | | 0.9 | | V |
| Input Voltage Range | Full | AGND | | AVDD | V |
| High Level Input Voltage | Full | 1.2 | | AVDD | V |
| Low Level Input Voltage | Full | AGND | | 0.6 | V |
| High Level Input Current | Full | -5 | | +5 | μA |
| Low Level Input Current | Full | -5 | | +5 | μA |
| Input Capacitance | Full | | 1 | | pF |
| Input Resistance | Full | 12 | 16 | 20 | kΩ |
| LOGIC INPUT (CSB)¹ | | | | | |
| High Level Input Voltage | Full | 1.22 | | 2.1 | V |
| Low Level Input Voltage | Full | 0 | | 0.6 | V |
| High Level Input Current | Full | -5 | | +5 | μA |
| Low Level Input Current | Full | -80 | | -45 | μA |
| Input Resistance | Full | | 26 | | kΩ |
| Input Capacitance | Full | | 2 | | pF |
| LOGIC INPUT (SCLK)² | | | | | |
| High Level Input Voltage | Full | 1.22 | | 2.1 | V |
| Low Level Input Voltage | Full | 0 | | 0.6 | V |
| High Level Input Current | Full | 45 | | 70 | μA |
| Low Level Input Current | Full | -5 | | +5 | μA |
| Input Resistance | Full | | 26 | | kΩ |
| Input Capacitance | Full | | 2 | | pF |
| LOGIC INPUTS (SDIO)² | | | | | |
| High Level Input Voltage | Full | 1.22 | | 2.1 | V |
| Low Level Input Voltage | Full | 0 | | 0.6 | V |
| High Level Input Current | Full | 45 | | 70 | μA |
| Low Level Input Current | Full | -5 | | +5 | μA |
| Input Resistance | Full | | 26 | | kΩ |
| Input Capacitance | Full | | 5 | | pF |
| LOGIC INPUTS (OEB, PDWN)² | | | | | |
| High Level Input Voltage | Full | 1.22 | | 2.1 | V |
| Low Level Input Voltage | Full | 0 | | 0.6 | V |
| High Level Input Current | Full | 45 | | 70 | μA |
| Low Level Input Current | Full | -5 | | +5 | μA |
| Input Resistance | Full | | 26 | | kΩ |
| Input Capacitance | Full | | 5 | | pF |

| Parameter | Temp | Min | Typ | Max | Unit |
|---|------|------|------|------|------|
| DIGITAL OUTPUTS | | | | | |
| LVDS Data and OR Outputs | | | | | |
| Differential Output Voltage (VOD), ANSI Mode | Full | 250 | 350 | 450 | mV |
| Output Offset Voltage (VOS), ANSI Mode | Full | 1.15 | 1.22 | 1.35 | V |
| Differential Output Voltage (VOD), Reduced Swing Mode | Full | 150 | 200 | 280 | mV |
| Output Offset Voltage (VOS), Reduced Swing Mode | Full | 1.15 | 1.22 | 1.35 | V |

¹ Pull-up.

² Pull-down.

SWITCHING SPECIFICATIONS

Table 4.

| Parameter | Temp | AD9643-170 | | | AD9643-210 | | | AD9643-250 | | | Unit |
|--|------|------------|-----|------|------------|-----|------|------------|-----|-----|---------|
| | | Min | Typ | Max | Min | Typ | Max | Min | Typ | Max | |
| CLOCK INPUT PARAMETERS | | | | | | | | | | | |
| Input Clock Rate | Full | | | 625 | | | 625 | | | 625 | MHz |
| Conversion Rate ¹ | Full | 40 | | 170 | 40 | | 210 | 40 | | 250 | MSPS |
| CLK Period—Divide-by-1 Mode (t_{CLK}) | Full | 5.8 | | | 4.8 | | | 4 | | | ns |
| CLK Pulse Width High (t_{CH}) | | | | | | | | | | | |
| Divide-by-1 Mode, DCS Enabled | Full | 2.61 | 2.9 | 3.19 | 2.16 | 2.4 | 2.64 | 1.8 | 2.0 | 2.2 | ns |
| Divide-by-1 Mode, DCS Disabled | Full | 2.76 | 2.9 | 3.05 | 2.28 | 2.4 | 2.52 | 1.9 | 2.0 | 2.1 | ns |
| Divide-by-2 Mode Through Divide-by-8 Mode | Full | 0.8 | | | 0.8 | | | 0.8 | | | ns |
| Aperture Delay (t_A) | Full | | 1.0 | | | 1.0 | | | 1.0 | | ns |
| Aperture Uncertainty (Jitter, t_j) | Full | | 0.1 | | | 0.1 | | | 0.1 | | ps rms |
| DATA OUTPUT PARAMETERS | | | | | | | | | | | |
| LVDS Mode | | | | | | | | | | | |
| Data Propagation Delay (t_{PD}) | Full | | 6.0 | | | 6.0 | | | 6.0 | | ns |
| DCO Propagation Delay (t_{DCO}) | Full | | 6.7 | | | 6.7 | | | 6.7 | | ns |
| DCO-to-Data Skew (t_{SKEW}) | Full | 0.4 | 0.7 | 1.0 | 0.4 | 0.7 | 1.0 | 0.4 | 0.7 | 1.0 | ns |
| Pipeline Delay (Latency) | Full | | 10 | | | 10 | | | 10 | | Cycles |
| Aperture Delay (t_A) | Full | | 1.0 | | | 1.0 | | | 1.0 | | ns |
| Aperture Uncertainty (Jitter, t_j) | Full | | 0.1 | | | 0.1 | | | 0.1 | | ps rms |
| Wake-Up Time (from Standby) | Full | | 10 | | | 10 | | | 10 | | μ s |
| Wake-Up Time (from Power-Down) | Full | | 250 | | | 250 | | | 250 | | μ s |
| Out-of-Range Recovery Time | Full | | 3 | | | 3 | | | 3 | | Cycles |

¹ Conversion rate is the clock rate after the divider.

TIMING SPECIFICATIONS

Table 5.

| Parameter | Conditions | Min | Typ | Max | Unit |
|---------------------------------|---|-----|-----|-----|------|
| SYNC TIMING REQUIREMENTS | | | | | |
| t _{SSYNC} | SYNC to the rising edge of CLK setup time | 1 | 0.3 | | ns |
| t _{HSYNC} | SYNC to the rising edge of CLK hold time | 1 | 0.4 | | ns |
| SPI TIMING REQUIREMENTS | | | | | |
| t _{DS} | Setup time between the data and the rising edge of SCLK | 2 | | | ns |
| t _{DH} | Hold time between the data and the rising edge of SCLK | 2 | | | ns |
| t _{CLK} | Period of the SCLK | 40 | | | ns |
| t _S | Setup time between CSB and SCLK | 2 | | | ns |
| t _H | Hold time between CSB and SCLK | 2 | | | ns |
| t _{HIGH} | Minimum period that SCLK should be in a logic high state | 10 | | | ns |
| t _{LOW} | Minimum period that SCLK should be in a logic low state | 10 | | | ns |
| t _{EN_SDIO} | Time required for the SDIO pin to switch from an input to an output relative to the SCLK falling edge | 10 | | | ns |
| t _{DIS_SDIO} | Time required for the SDIO pin to switch from an output to an input relative to the SCLK rising edge | 10 | | | ns |

Timing Diagrams

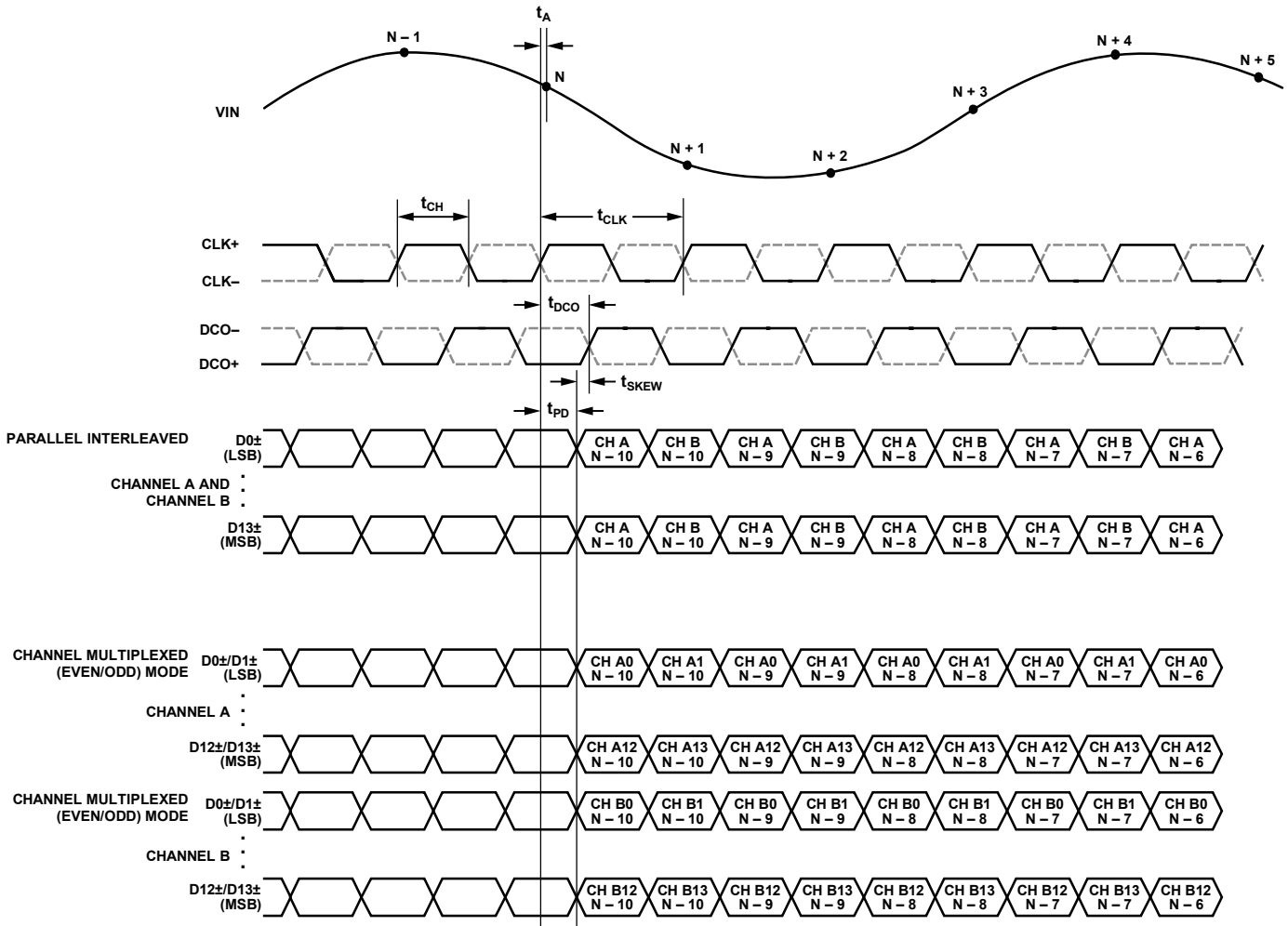

Figure 2. LVDS Modes for Data Output Timing

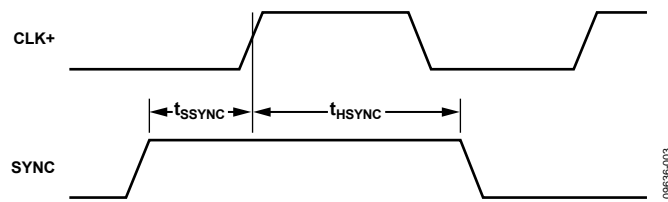

Figure 3. SYNC Timing Inputs

09836-002

09836-003

ABSOLUTE MAXIMUM RATINGS

Table 6.

| Parameter | Rating |
|---|-------------------------|
| Electrical | |
| AVDD to AGND | −0.3 V to +2.0 V |
| DRVDD to AGND | −0.3 V to +2.0 V |
| VIN+A/VIN+B, VIN−A/VIN−B to AGND | −0.3 V to AVDD + 0.2 V |
| CLK+, CLK− to AGND | −0.3 V to AVDD + 0.2 V |
| SYNC to AGND | −0.3 V to AVDD + 0.2 V |
| VCM to AGND | −0.3 V to AVDD + 0.2 V |
| CSB to AGND | −0.3 V to DRVDD + 0.3 V |
| SCLK to AGND | −0.3 V to DRVDD + 0.3 V |
| SDIO to AGND | −0.3 V to DRVDD + 0.3 V |
| OEB to AGND | −0.3 V to DRVDD + 0.3 V |
| PDWN to AGND | −0.3 V to DRVDD + 0.3 V |
| OR+/OR− to AGND | −0.3 V to DRVDD + 0.3 V |
| D0−/D0+ Through D13−/D13+ to AGND | −0.3 V to DRVDD + 0.3 V |
| DCO+/DCO− to AGND | −0.3 V to DRVDD + 0.3 V |
| Environmental | |
| Operating Temperature Range (Ambient) | −40°C to +85°C |
| Maximum Junction Temperature Under Bias | 150°C |
| Storage Temperature Range (Ambient) | −65°C to +125°C |

Stresses above those listed under Absolute Maximum Ratings may cause permanent damage to the device. This is a stress rating only; functional operation of the device at these or any other conditions above those indicated in the operational section of this specification is not implied. Exposure to absolute maximum rating conditions for extended periods may affect device reliability.

THERMAL CHARACTERISTICS

The exposed paddle must be soldered to the ground plane for the LFCSP package. This increases the reliability of the solder joints, maximizing the thermal capability of the package.

Table 7. Thermal Resistance

| Package Type | Airflow Velocity (m/sec) | $\theta_{JA}^{1,2}$ | $\theta_{JC}^{1,3}$ | $\theta_{JB}^{1,4}$ | Unit |
|---|--------------------------|---------------------|---------------------|---------------------|------|
| 64-Lead LFCSP 9 mm × 9 mm (CP-64-4) | 0 | 26.8 | 1.14 | 10.4 | °C/W |
| | 1.0 | 21.6 | | | °C/W |
| | 2.0 | 20.2 | | | °C/W |

¹ Per JEDEC 51-7, plus JEDEC 25-5 2S2P test board.

² Per JEDEC JESD51-2 (still air) or JEDEC JESD51-6 (moving air).

³ Per MIL-Std 883, Method 1012.1.

⁴ Per JEDEC JESD51-8 (still air).

Typical θ_{JA} is specified for a 4-layer PCB with a solid ground plane. As shown in Table 7, airflow increases heat dissipation, which reduces θ_{JA} . In addition, metal in direct contact with the package leads from metal traces, through holes, ground, and power planes, reduces the θ_{JA} .

ESD CAUTION



ESD (electrostatic discharge) sensitive device.

Charged devices and circuit boards can discharge without detection. Although this product features patented or proprietary protection circuitry, damage may occur on devices subjected to high energy ESD. Therefore, proper ESD precautions should be taken to avoid performance degradation or loss of functionality.

PIN CONFIGURATIONS AND FUNCTION DESCRIPTIONS

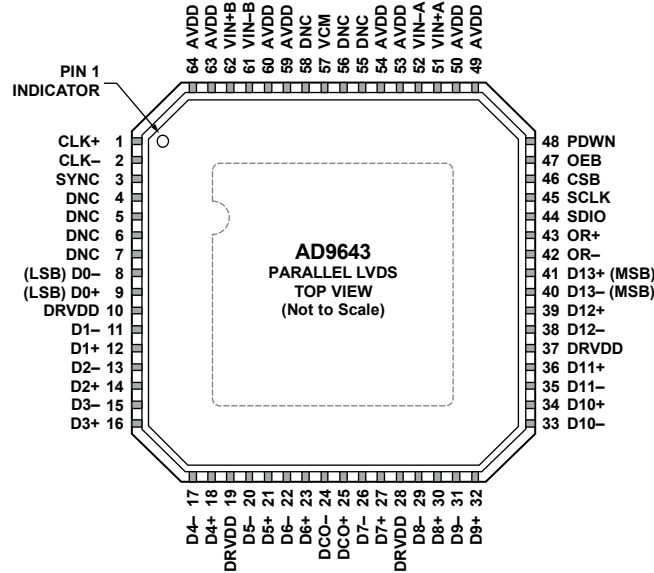

- NOTES**
1. DNC = DO NOT CONNECT. DO NOT CONNECT TO THIS PIN.
 2. THE EXPOSED THERMAL PADDLE ON THE BOTTOM OF THE PACKAGE PROVIDES THE ANALOG GROUND FOR THE PART. THIS EXPOSED PADDLE MUST BE CONNECTED TO GROUND FOR PROPER OPERATION.

081636-004

Figure 4. LFCSP Interleaved Parallel LVDS Pin Configuration (Top View)

Table 8. Pin Function Descriptions for Interleaved Parallel LVDS Mode

| Pin No. | Mnemonic | Type | Description |
|---|---|--|--|
| ADC Power Supplies 10, 19, 28, 37 49, 50, 53, 54, 59, 60, 63, 64 4, 5, 6, 7, 55, 56, 58 0 | DRVDD AVDD DNC AGND, Exposed Paddle | Supply Supply Ground | Digital Output Driver Supply (1.8 V Nominal). Analog Power Supply (1.8 V Nominal). Do Not Connect. Do not connect to this pin. Analog Ground. The exposed thermal paddle on the bottom of the package provides the analog ground for the part. This exposed paddle must be connected to ground for proper operation. |
| ADC Analog 51 52 62 61 57 1 2 | VIN+A VIN-A VIN+B VIN-B VCM CLK+ CLK- | Input Input Input Input Output Input Input | Differential Analog Input Pin (+) for Channel A. Differential Analog Input Pin (-) for Channel A. Differential Analog Input Pin (+) for Channel B. Differential Analog Input Pin (-) for Channel B. Common-Mode Level Bias Output for Analog Inputs. This pin should be decoupled to ground using a 0.1 μF capacitor. ADC Clock Input—True. ADC Clock Input—Complement. |
| Digital Input 3 | SYNC | Input | Digital Synchronization Pin. Slave mode only. |
| Digital Outputs 9 8 12 11 14 13 16 15 18 | D0+ (LSB) D0- (LSB) D1+ D1- D2+ D2- D3+ D3- D4+ | Output Output Output Output Output Output Output Output Output | Channel A/Channel B LVDS Output Data 0—True. Channel A/Channel B LVDS Output Data 0—Complement. Channel A/Channel B LVDS Output Data 1—True. Channel A/Channel B LVDS Output Data 1—Complement. Channel A/Channel B LVDS Output Data 2—True. Channel A/Channel B LVDS Output Data 2—Complement. Channel A/Channel B LVDS Output Data 3—True. Channel A/Channel B LVDS Output Data 3—Complement. Channel A/Channel B LVDS Output Data 4—True. |

| Pin No. | Mnemonic | Type | Description |
|---|------------|--------------|--|
| 17 | D4- | Output | Channel A/Channel B LVDS Output Data 4—Complement. |
| 21 | D5+ | Output | Channel A/Channel B LVDS Output Data 5—True. |
| 20 | D5- | Output | Channel A/Channel B LVDS Output Data 5—Complement. |
| 23 | D6+ | Output | Channel A/Channel B LVDS Output Data 6—True. |
| 22 | D6- | Output | Channel A/Channel B LVDS Output Data 6—Complement. |
| 27 | D7+ | Output | Channel A/Channel B LVDS Output Data 7—True. |
| 26 | D7- | Output | Channel A/Channel B LVDS Output Data 7—Complement. |
| 30 | D8+ | Output | Channel A/Channel B LVDS Output Data 8—True. |
| 29 | D8- | Output | Channel A/Channel B LVDS Output Data 8—Complement. |
| 32 | D9+ | Output | Channel A/Channel B LVDS Output Data 9—True. |
| 31 | D9- | Output | Channel A/Channel B LVDS Output Data 9—Complement. |
| 34 | D10+ | Output | Channel A/Channel B LVDS Output Data 10—True. |
| 33 | D10- | Output | Channel A/Channel B LVDS Output Data 10—Complement. |
| 36 | D11+ | Output | Channel A/Channel B LVDS Output Data 11—True. |
| 35 | D11- | Output | Channel A/Channel B LVDS Output Data 11—Complement. |
| 39 | D12+ | Output | Channel A/Channel B LVDS Output Data 12—True. |
| 38 | D12- | Output | Channel A/Channel B LVDS Output Data 12—Complement. |
| 41 | D13+ (MSB) | Output | Channel A/Channel B LVDS Output Data 13—True. |
| 40 | D13- (MSB) | Output | Channel A/Channel B LVDS Output Data 13—Complement. |
| 43 | OR+ | Output | Channel A/Channel B LVDS Overage—True. |
| 42 | OR- | Output | Channel A/Channel B LVDS Overage—Complement. |
| 25 | DCO+ | Output | Channel A/Channel B LVDS Data Clock Output—True. |
| 24 | DCO- | Output | Channel A/Channel B LVDS Data Clock Output—Complement. |
| SPI Control | | | |
| 45 | SCLK | Input | SPI Serial Clock. |
| 44 | SDIO | Input/Output | SPI Serial Data I/O. |
| 46 | CSB | Input | SPI Chip Select (Active Low). |
| Output Enable Bar and Power-Down | | | |
| 47 | OEB | Input/Output | Output Enable Bar Input (Active Low). |
| 48 | PDWN | Input/Output | Power-Down Input (Active High). The operation of this pin depends on the SPI mode and can be configured as power-down or standby (see Table 14). |

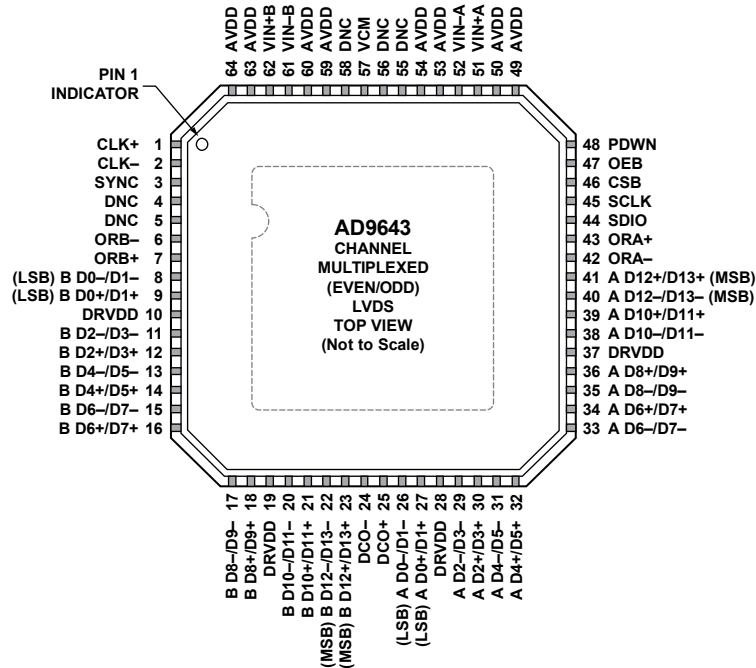

NOTES

1. DNC = DO NOT CONNECT. DO NOT CONNECT TO THIS PIN.
2. THE EXPOSED THERMAL PADDLE ON THE BOTTOM OF THE PACKAGE PROVIDES THE ANALOG GROUND FOR THE PART. THIS EXPOSED PADDLE MUST BE CONNECTED TO GROUND FOR PROPER OPERATION.

09636-005

Figure 5. LFCSP Channel Multiplexed (Even/Odd) LVDS Pin Configuration (Top View)

Table 9. Pin Function Descriptions for Channel Multiplexed (Even/Odd) LVDS Mode

| Pin No. | Mnemonic | Type | Description |
|---|--|--|---|
| ADC Power Supplies 10, 19, 28, 37 49, 50, 53, 54, 59, 60, 63, 64 4, 5 0 | DRVDD AVDD DNC AGND, Exposed Paddle | Supply Supply Ground | Digital Output Driver Supply (1.8 V Nominal). Analog Power Supply (1.8 V Nominal). Do Not Connect. Do not connect to this pin. Analog Ground. The exposed thermal paddle on the bottom of the package provides the analog ground for the part. This exposed paddle must be connected to ground for proper operation. |
| ADC Analog 51 52 62 61 55 56 58 57 1 2 | VIN+A VIN-A VIN+B VIN-B DNC DNC DNC VCM CLK+ CLK- | Input Input Input Input Output Input Input | Differential Analog Input Pin (+) for Channel A. Differential Analog Input Pin (-) for Channel A. Differential Analog Input Pin (+) for Channel B. Differential Analog Input Pin (-) for Channel B. Do Not Connect. Do not connect to this pin. Do Not Connect. Do not connect to this pin. Do Not Connect. Do not connect to this pin. Common-Mode Level Bias Output for Analog Inputs. This pin should be decoupled to ground using a 0.1 μ F capacitor. ADC Clock Input—True. ADC Clock Input—Complement. |
| Digital Input 3 | SYNC | Input | Digital Synchronization Pin. Slave mode only. |

| Pin No. | Mnemonic | Type | Description |
|---|-------------------|--------------|--|
| Digital Outputs | | | |
| 7 | ORB+ | Output | Channel B LVDS Overage Output—True. The overrange indication is valid on the rising edge of the DCO. |
| 6 | ORB– | Output | Channel B LVDS Overage Output—Complement. The overrange indication is valid on the rising edge of the DCO. |
| 8 | B D0–/D1– (LSB) | Output | Channel B LVDS Output Data 0/Data 1—Complement. |
| 9 | B D0+/D1+ (LSB) | Output | Channel B LVDS Output Data 0/Data 1—True. |
| 11 | B D2–/D3– | Output | Channel B LVDS Output Data 2/Data 3—Complement. |
| 12 | B D2+/D3+ | Output | Channel B LVDS Output Data 2/Data 3—True. |
| 13 | B D4–/D5– | Output | Channel B LVDS Output Data 4/Data 5—Complement. |
| 14 | B D4+/D5+ | Output | Channel B LVDS Output Data 4/Data 5—True. |
| 15 | B D6–/D7– | Output | Channel B LVDS Output Data 6/Data 7—Complement. |
| 16 | B D6+/D7+ | Output | Channel B LVDS Output Data 6/Data 7—True. |
| 17 | B D8–/D9– | Output | Channel B LVDS Output Data 8/Data 9—Complement. |
| 18 | B D8+/D9+ | Output | Channel B LVDS Output Data 8/Data 9—True. |
| 20 | B D10–/D11– | Output | Channel B LVDS Output Data 10/Data 11—Complement. |
| 21 | B D10+/D11+ | Output | Channel B LVDS Output Data 10/Data 11—True. |
| 22 | B D12–/D13– (MSB) | Output | Channel B LVDS Output Data 12/Data 13—Complement. |
| 23 | B D12+/D13+ (MSB) | Output | Channel B LVDS Output Data 12/Data 13—True. |
| 26 | A D0–/D1– (LSB) | Output | Channel A LVDS Output Data 0/Data 1—Complement. |
| 27 | A D0+/D1+ (LSB) | Output | Channel A LVDS Output Data 0/Data 1—True. |
| 29 | A D2–/D3– | Output | Channel A LVDS Output Data 2/Data 3—Complement. |
| 30 | A D2+/D3+ | Output | Channel A LVDS Output Data 2/Data 3—True. |
| 31 | A D4–/D5– | Output | Channel A LVDS Output Data 4/Data 5—Complement. |
| 32 | A D4+/D5+ | Output | Channel A LVDS Output Data 4/Data 5—True. |
| 33 | A D6–/D7– | Output | Channel A LVDS Output Data 6/Data 7—Complement. |
| 34 | A D6+/D7+ | Output | Channel A LVDS Output Data 6/Data 7—True. |
| 35 | A D8–/D9– | Output | Channel A LVDS Output Data 8/Data 9—Complement. |
| 36 | A D8+/D9+ | Output | Channel A LVDS Output Data 8/Data 9—True. |
| 38 | A D10–/D11– | Output | Channel A LVDS Output Data 10/Data 11—Complement. |
| 39 | A D10+/D11+ | Output | Channel A LVDS Output Data 10/Data 11—True. |
| 40 | A D12–/D13– (MSB) | Output | Channel A LVDS Output Data 12/Data 13—Complement. |
| 41 | A D12+/D13+ (MSB) | Output | Channel A LVDS Output Data 12/Data 13—True. |
| 43 | ORA+ | Output | Channel A LVDS Overage Output—True. The overrange indication is valid on the rising edge of the DCO. |
| 42 | ORA– | Output | Channel A LVDS Overage Output—Complement. The overrange indication is valid on the rising edge of the DCO. |
| 25 | DCO+ | Output | Channel A/Channel B LVDS Data Clock Output—True. |
| 24 | DCO– | Output | Channel A/Channel B LVDS Data Clock Output—Complement. |
| SPI Control | | | |
| 45 | SCLK | Input | SPI Serial Clock. |
| 44 | SDIO | Input/Output | SPI Serial Data Input/Output. |
| 46 | CSB | Input | SPI Chip Select (Active Low). |
| Output Enable Bar and Power-Down | | | |
| 47 | OEB | Input | Output Enable Bar Input (Active Low). |
| 48 | PDWN | Input | Power-Down Input (Active High). The operation of this pin depends on the SPI mode and can be configured as power-down or standby (see Table 14). |

TYPICAL PERFORMANCE CHARACTERISTICS

AVDD = 1.8 V, DRVDD = 1.8 V, sample rate = maximum sample rate per speed grade, DCS enabled, 1.75 V p-p differential input, VIN = -1.0 dBFS, 32k sample, TA = 25°C, unless otherwise noted.

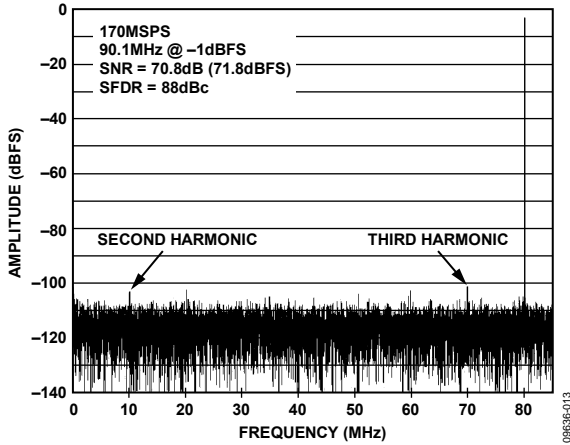

Figure 6. AD9643-170 Single-Tone FFT with $f_{IN} = 90.1$ MHz

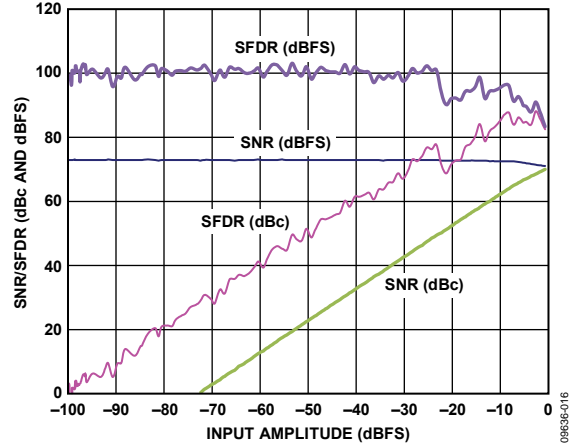

Figure 9. AD9643-170 Single-Tone SNR/SFDR vs. Input Amplitude (A_{IN}) with $f_{IN} = 90.1$ MHz

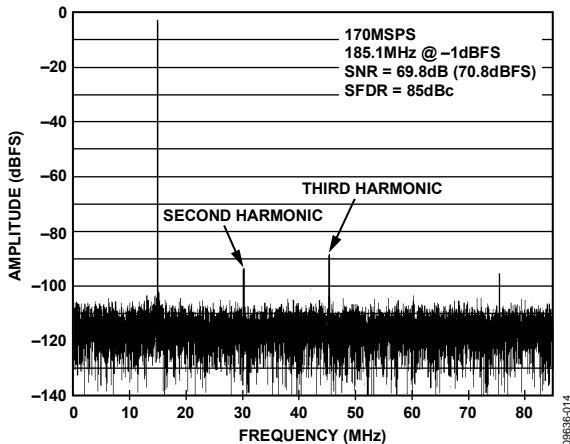

Figure 7. AD9643-170 Single-Tone FFT with $f_{IN} = 185.1$ MHz

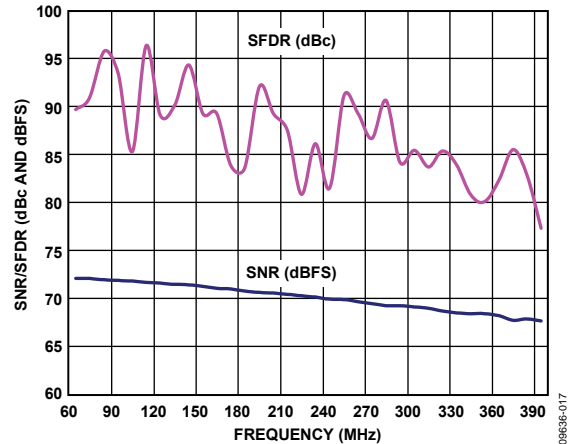

Figure 10. AD9643-170 Single-Tone SNR/SFDR vs. Input Frequency (f_{IN})

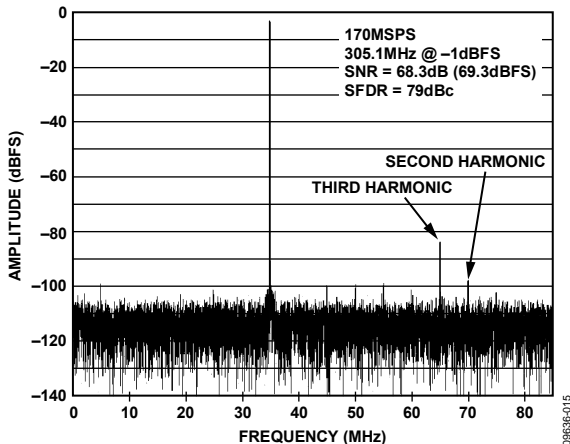

Figure 8. AD9643-170 Single-Tone FFT with $f_{IN} = 305.1$ MHz

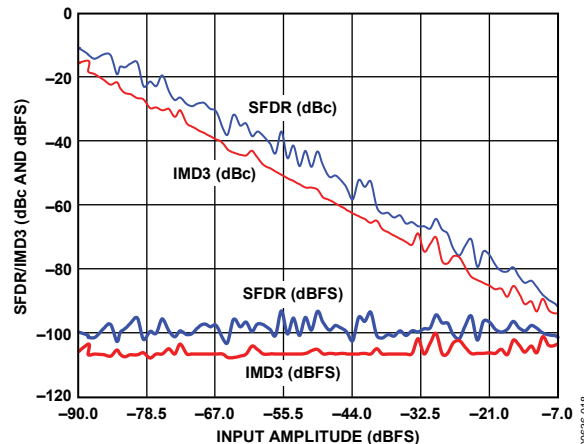

Figure 11. AD9643-170 Two-Tone SFDR/IMD3 vs. Input Amplitude (A_{IN}) with $f_{IN1} = 89.12$, $f_{IN2} = 92.12$ MHz, $f_S = 170$ MSPS

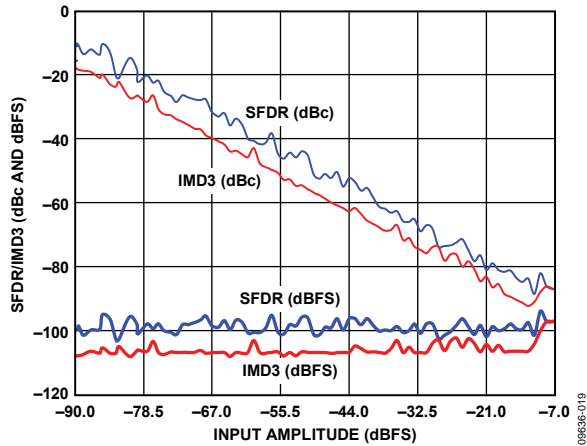

Figure 12. AD9643-170 Two-Tone SFDR/IMD3 vs. Input Amplitude (A_{IN}) with $f_{IN1} = 184.12$, $f_{IN2} = 187.12$ MHz, $f_s = 170$ MSPS

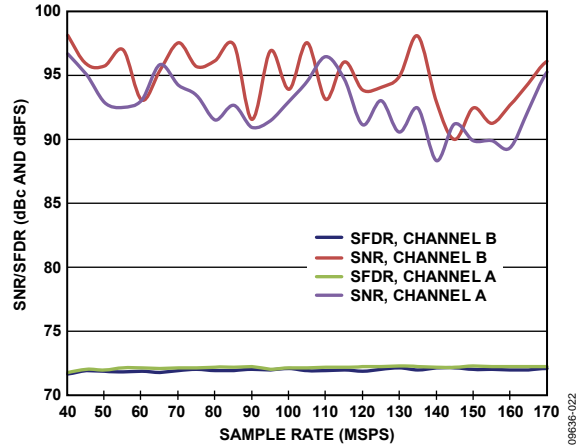

Figure 15. AD9643-170 Single-Tone SNR/SFDR vs. Sample Rate (f_s) with $f_{IN} = 90.1$ MHz

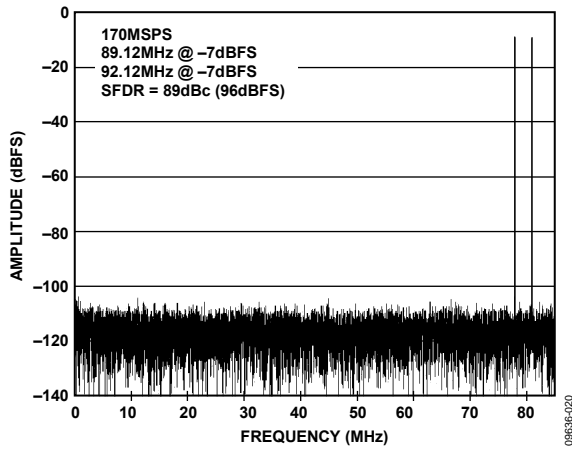

Figure 13. AD9643-170 Two-Tone FFT with $f_{IN1} = 89.12$, $f_{IN2} = 92.12$ MHz, $f_s = 170$ MSPS

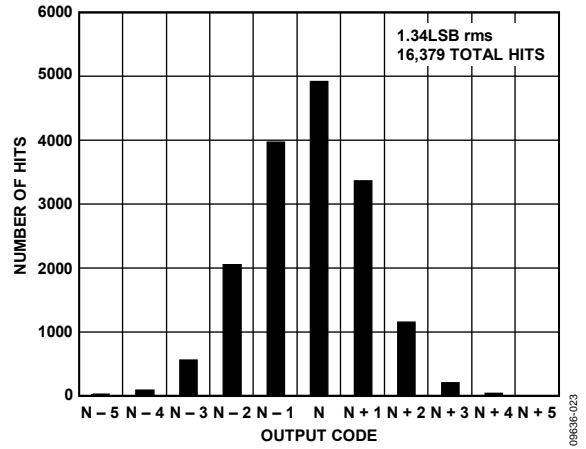

Figure 16. AD9643-170 Grounded Input Histogram

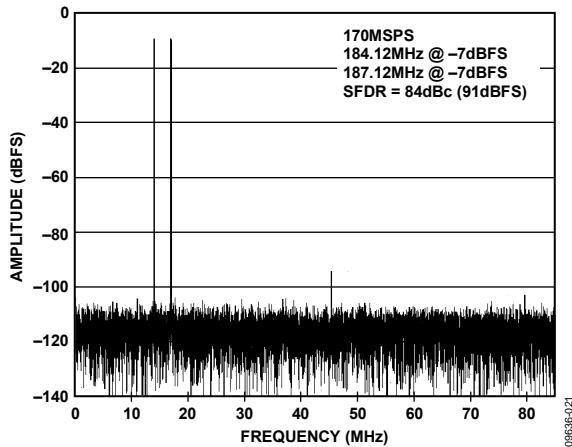

Figure 14. AD9643-170 Two-Tone FFT with $f_{IN1} = 184.12$, $f_{IN2} = 187.12$ MHz, $f_s = 170$ MSPS

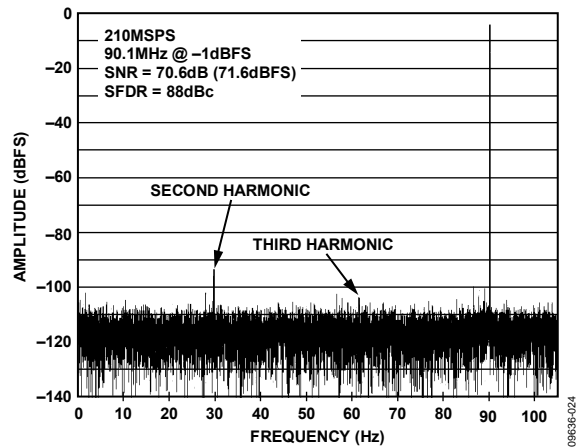

Figure 17. AD9643-210 Single-Tone FFT with $f_{IN} = 90.1$ MHz

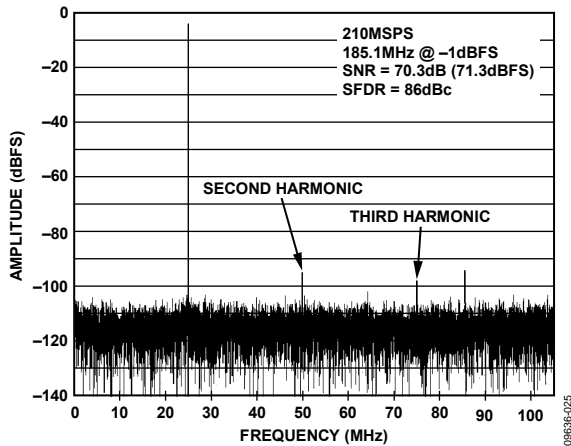

Figure 18. AD9643-210 Single-Tone FFT with $f_{IN} = 185.1$ MHz

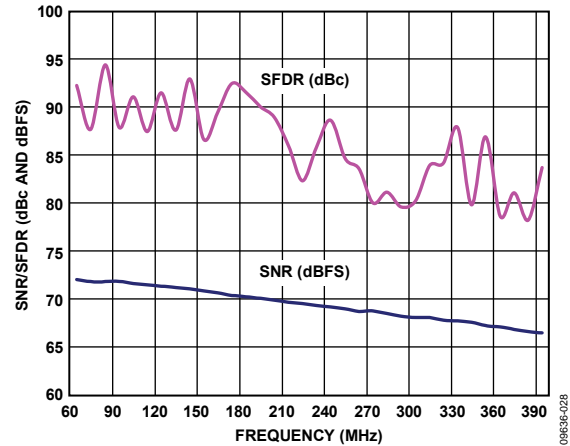

Figure 21. AD9643-210 Single-Tone SNR/SFDR vs. Input Frequency (f_{IN})

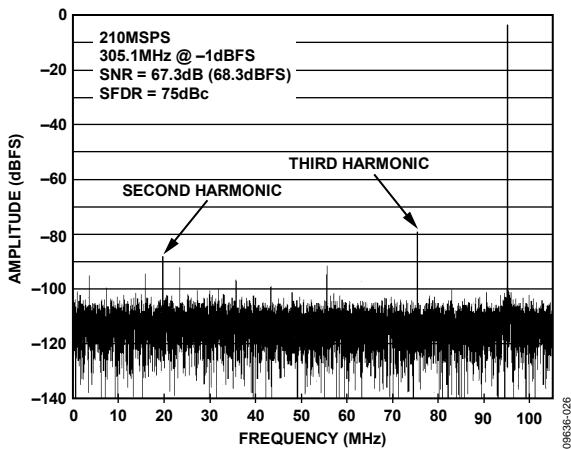

Figure 19. AD9643-210 Single-Tone FFT with $f_{IN} = 305.1$ MHz

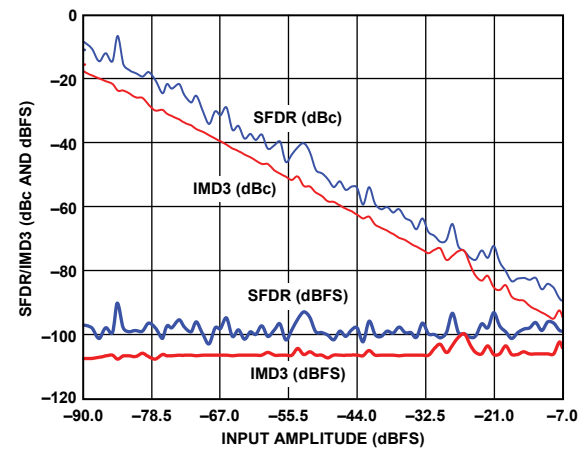

Figure 22. AD9643-210 Two-Tone SFDR/IMD3 vs. Input Amplitude (A_{IN}) with $f_{IN1} = 89.12$, $f_{IN2} = 92.12$ MHz, $f_s = 210$ MSPS

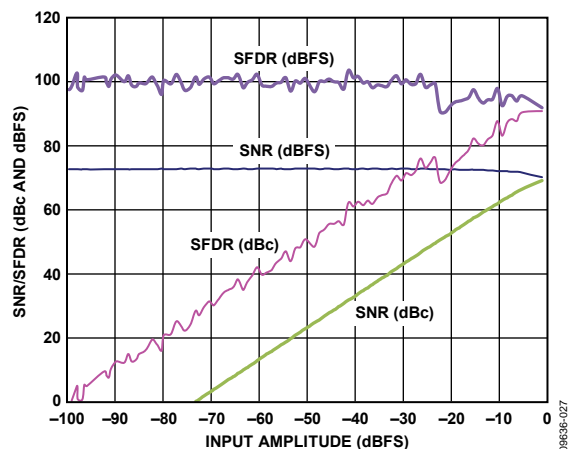

Figure 20. AD9643-210 Single-Tone SNR/SFDR vs. Input Amplitude (A_{IN}) with $f_{IN} = 90.1$ MHz

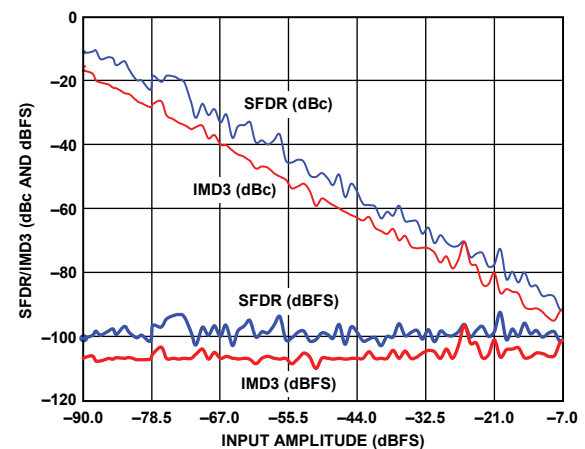

Figure 23. AD9643-210 Two-Tone SFDR/IMD3 vs. Input Amplitude (A_{IN}) with $f_{IN1} = 184.12$, $f_{IN2} = 187.12$ MHz, $f_s = 210$ MSPS

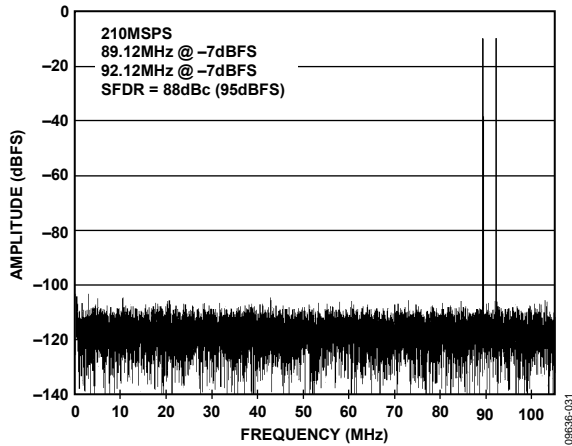

Figure 24. AD9643-210 Two-Tone FFT with $f_{IN1} = 89.12$, $f_{IN2} = 92.12$ MHz, $f_s = 210$ MSPS

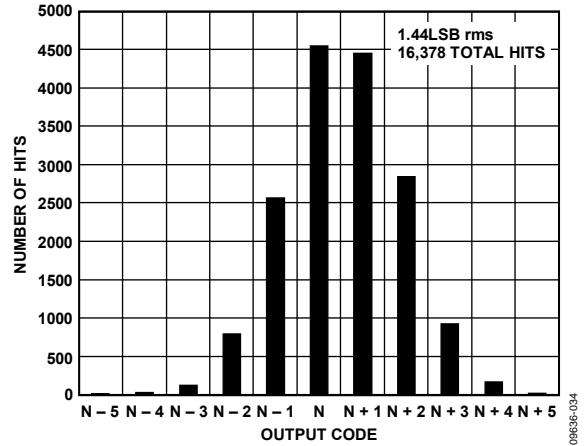

Figure 27. AD9643-210 Grounded Input Histogram

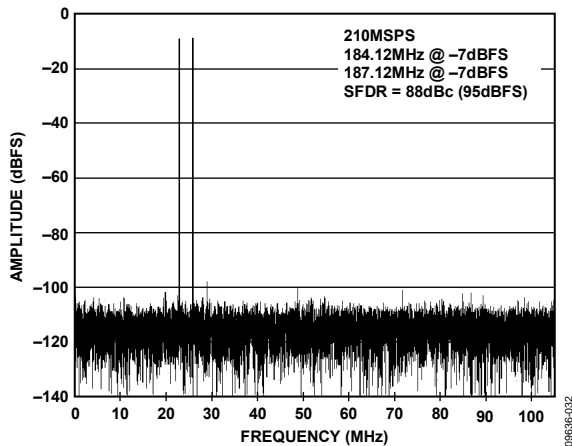

Figure 25. AD9643-210 Two-Tone FFT with $f_{IN1} = 184.12$, $f_{IN2} = 187.12$ MHz, $f_s = 210$ MSPS

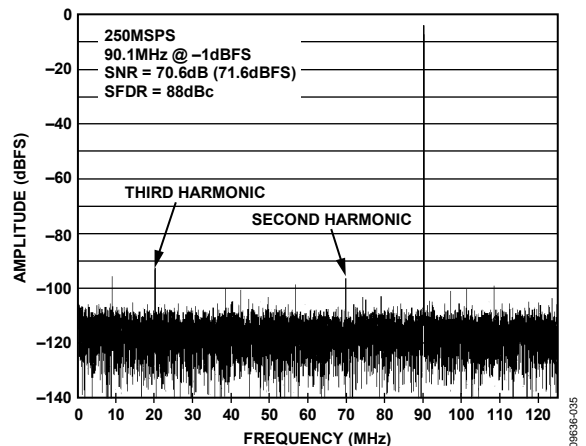

Figure 28. AD9643-250 Single-Tone FFT with $f_{IN} = 90.1$ MHz

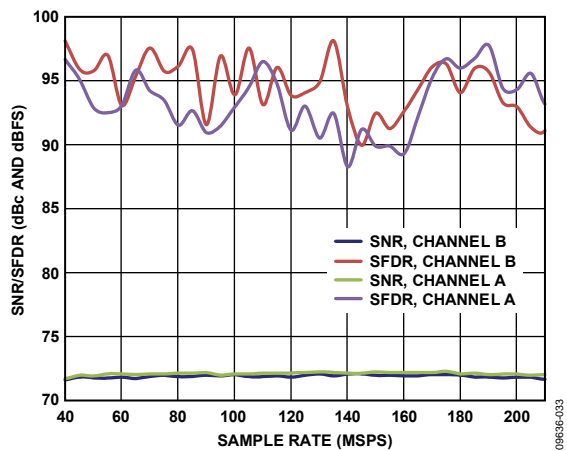

Figure 26. AD9643-210 Single-Tone SNR/SFDR vs. Sample Rate (f_s) with $f_{IN} = 90.1$ MHz

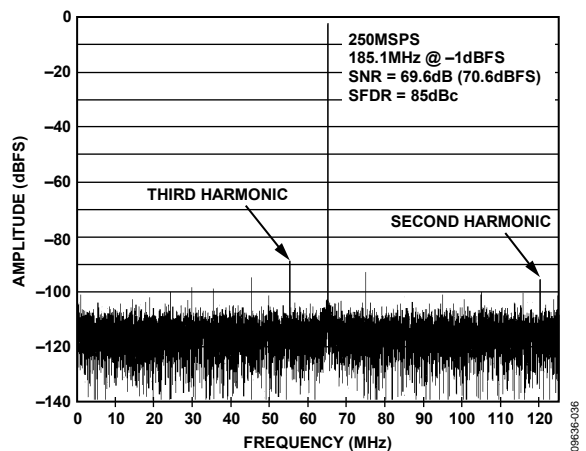

Figure 29. AD9643-250 Single-Tone FFT with $f_{IN} = 185.1$ MHz

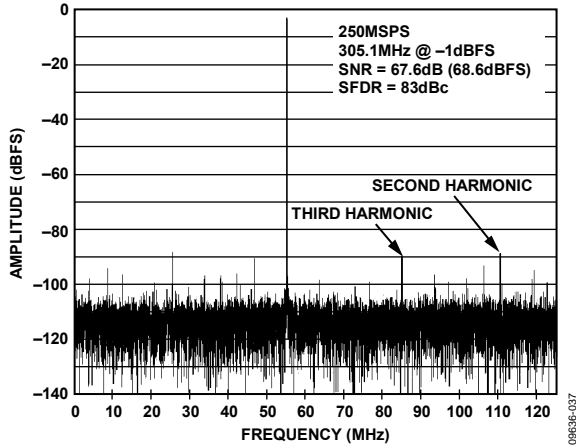

Figure 30. AD9643-250 Single-Tone FFT with $f_{IN} = 305.1$ MHz

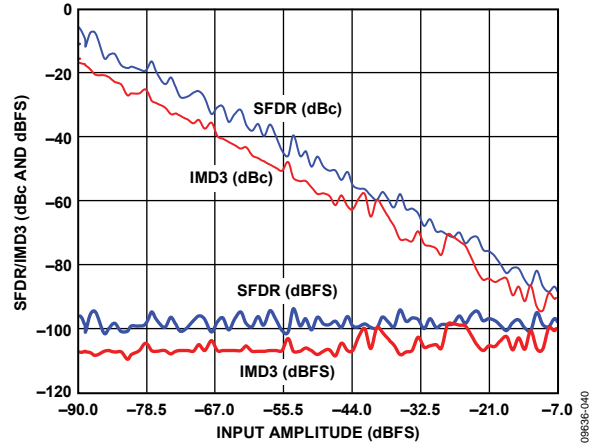

Figure 33. AD9643-250 Two-Tone SFDR/IMD3 vs. Input Amplitude (A_{IN}) with $f_{IN1} = 89.12$, $f_{IN2} = 92.12$ MHz, $f_s = 250$ MSPS

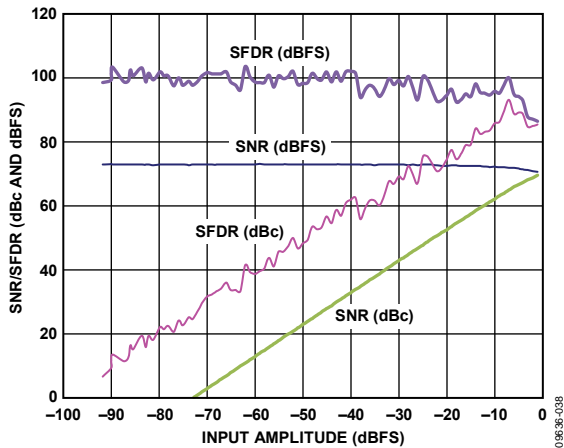

Figure 31. AD9643-250 Single-Tone SNR/SFDR vs. Input Amplitude (A_{IN}) with $f_{IN} = 185.1$ MHz

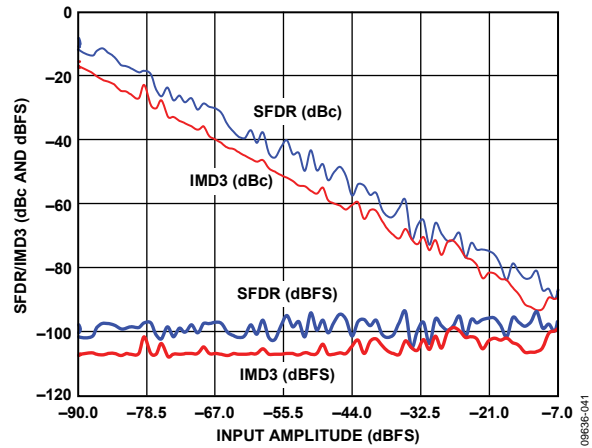

Figure 34. AD9643-250 Two-Tone SFDR/IMD3 vs. Input Amplitude (A_{IN}) with $f_{IN1} = 184.12$, $f_{IN2} = 187.12$ MHz, $f_s = 250$ MSPS

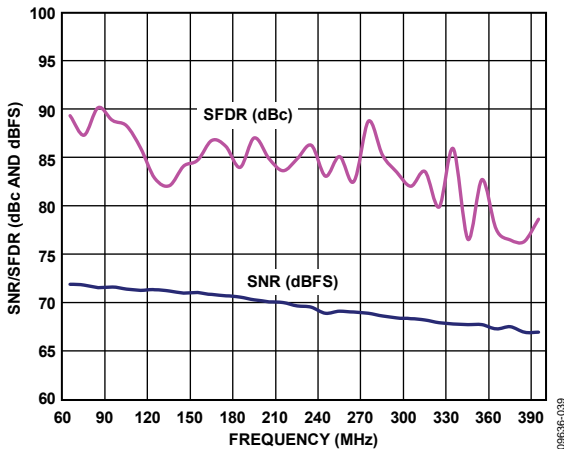

Figure 32. AD9643-250 Single-Tone SNR/SFDR vs. Input Frequency (f_{IN})

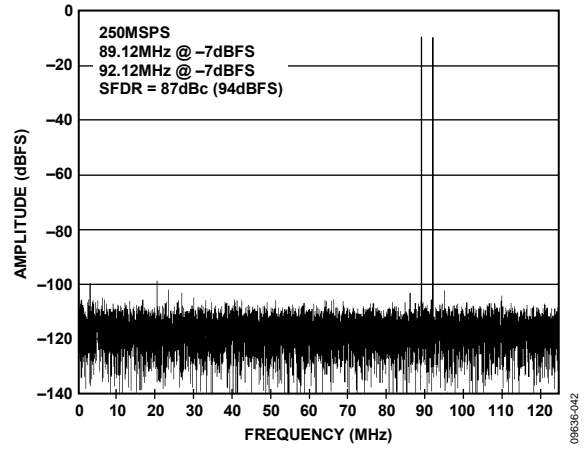

Figure 35. AD9643-250 Two-Tone FFT with $f_{IN1} = 89.12$, $f_{IN2} = 92.12$ MHz, $f_s = 250$ MSPS

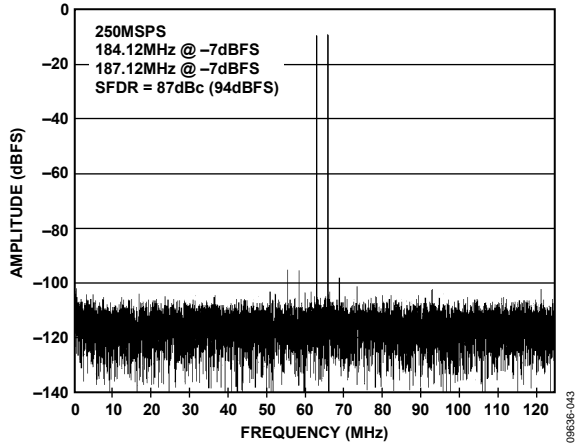

Figure 36. AD9643-250 Two-Tone FFT with $f_{IN1} = 184.12$, $f_{IN2} = 187.12$ MHz, $f_s = 250$ MSPS

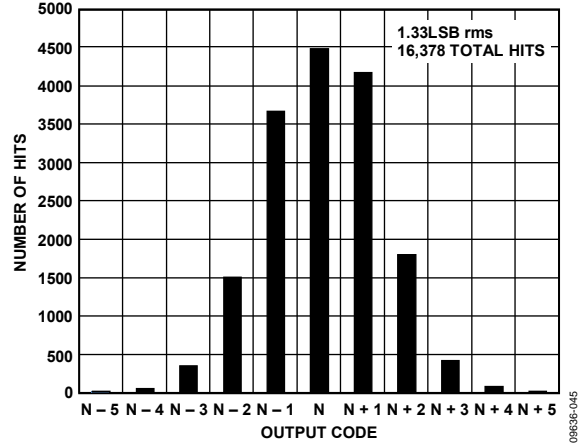

Figure 38. AD9643-250 Grounded Input Histogram

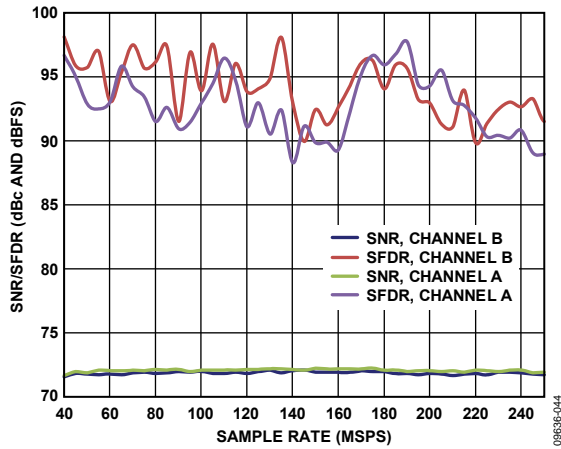

Figure 37. AD9643-250 Single-Tone SNR/SFDR vs. Sample Rate (f_s) with $f_{IN} = 90.1$ MHz

EQUIVALENT CIRCUITS

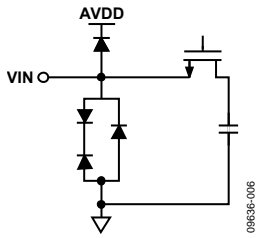

Figure 39. Equivalent Analog Input Circuit

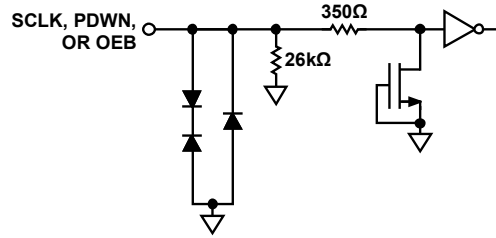

Figure 43. Equivalent SCLK, PDWN, or OEB Input Circuit

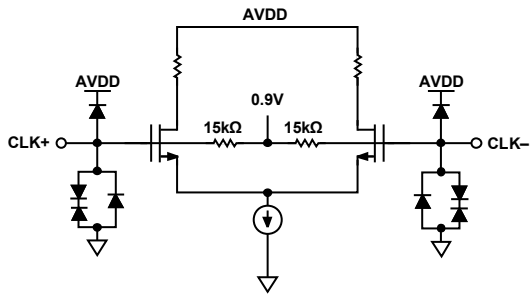

Figure 40. Equivalent Clock Input Circuit

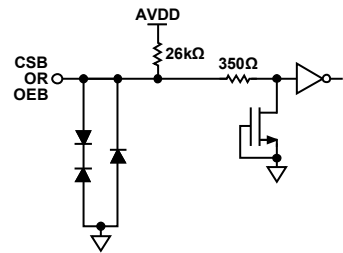

Figure 44. Equivalent CSB Input Circuit

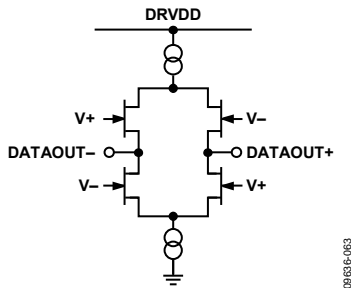

Figure 41. Equivalent LVDS Output Circuit

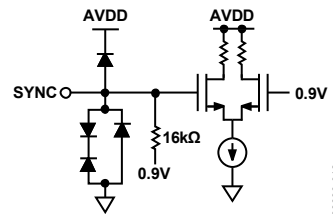

Figure 45. Equivalent SYNC Input Circuit

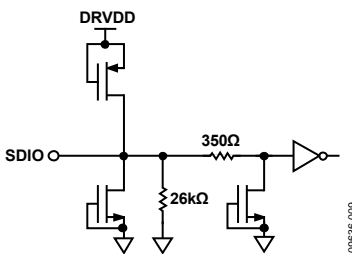

Figure 42. Equivalent SDIO Circuit

THEORY OF OPERATION

The AD9643 has two analog input channels and two digital output channels. The intermediate frequency (IF) signal passes through several stages before appearing at the output port(s).

The dual ADC design can be used for diversity reception of signals, where the ADCs operate identically on the same carrier but from two separate antennae. The ADCs can also be operated with independent analog inputs. The user can sample frequencies from dc to 300 MHz using appropriate low-pass or band-pass filtering at the ADC inputs with little loss in ADC performance. Operation to 400 MHz analog input is permitted but occurs at the expense of increased ADC noise and distortion.

Synchronization capability is provided to allow synchronized timing between multiple devices.

Programming and control of the AD9643 are accomplished using a 3-pin, SPI-compatible serial interface.

ADC ARCHITECTURE

The AD9643 architecture consists of a dual front-end sample-and-hold circuit, followed by a pipelined switched-capacitor ADC. The quantized outputs from each stage are combined into a final 14-bit result in the digital correction logic. The pipelined architecture permits the first stage to operate on a new input sample and the remaining stages to operate on the preceding samples. Sampling occurs on the rising edge of the clock.

Each stage of the pipeline, excluding the last, consists of a low resolution flash ADC connected to a switched-capacitor digital-to-analog converter (DAC) and an interstage residue amplifier (MDAC). The MDAC magnifies the difference between the reconstructed DAC output and the flash input for the next stage in the pipeline. One bit of redundancy is used in each stage to facilitate digital correction of flash errors. The last stage simply consists of a flash ADC.

The input stage of each channel contains a differential sampling circuit that can be ac- or dc-coupled in differential or single-ended modes. The output staging block aligns the data, corrects errors, and passes the data to the output buffers. The output buffers are powered from a separate supply, allowing digital output noise to be separated from the analog core. During power-down, the output buffers go into a high impedance state.

ANALOG INPUT CONSIDERATIONS

The analog input to the AD9643 is a differential switched-capacitor circuit that has been designed for optimum performance while processing a differential input signal.

The clock signal alternatively switches the input between sample mode and hold mode (see the configuration shown in Figure 46). When the input is switched into sample mode, the signal source must be capable of charging the sampling capacitors and settling within 1/2 clock cycle.

A small resistor in series with each input can help reduce the peak transient current required from the output stage of the driving source. A shunt capacitor can be placed across the inputs to provide dynamic charging currents. This passive network creates a low-pass filter at the ADC input; therefore, the precise values are dependent on the application.

In intermediate frequency (IF) undersampling applications, the shunt capacitors should be reduced. In combination with the driving source impedance, the shunt capacitors limit the input bandwidth. Refer to the AN-742 Application Note, *Frequency Domain Response of Switched-Capacitor ADCs*; the AN-827 Application Note, *A Resonant Approach to Interfacing Amplifiers to Switched-Capacitor ADCs*; and the Analog Dialogue article, "Transformer-Coupled Front-End for Wideband A/D Converters," for more information on this subject.

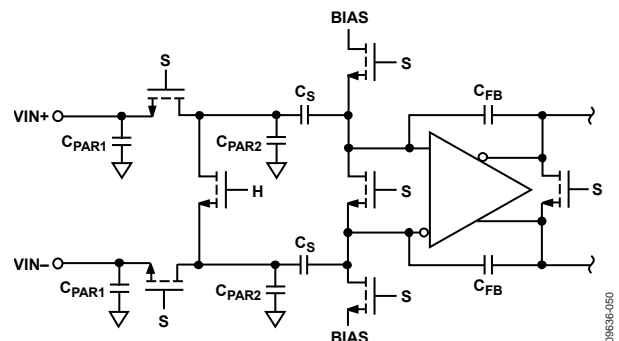

Figure 46. Switched-Capacitor Input

For best dynamic performance, the source impedances driving VIN+ and VIN- should be matched, and the inputs should be differentially balanced.

Input Common Mode

The analog inputs of the AD9643 are not internally dc biased. In ac-coupled applications, the user must provide this bias externally. Setting the device so that $V_{CM} = 0.5 \times AV_{DD}$ (or 0.9 V) is recommended for optimum performance. An on-board common-mode voltage reference is included in the design and is available from the VCM pin. Using the VCM output to set the input common mode is recommended. Optimum performance is achieved when the common-mode voltage of the analog input is set by the VCM pin voltage (typically $0.5 \times AV_{DD}$). The VCM pin must be decoupled to ground by a 0.1 μF capacitor, as described in the Applications Information section. This decoupling capacitor should be placed close to the pin to minimize the series resistance and inductance between the part and this capacitor.

Differential Input Configurations

Optimum performance is achieved while driving the AD9643 in a differential input configuration. For baseband applications, the AD8138, ADA4937-2, ADA4938-2, and ADA4930-2

differential drivers provide excellent performance and a flexible interface to the ADC.

The output common-mode voltage of the ADA4930-2 is easily set with the VCM pin of the AD9643 (see Figure 47), and the driver can be configured in a Sallen-Key filter topology to provide band-limiting of the input signal.

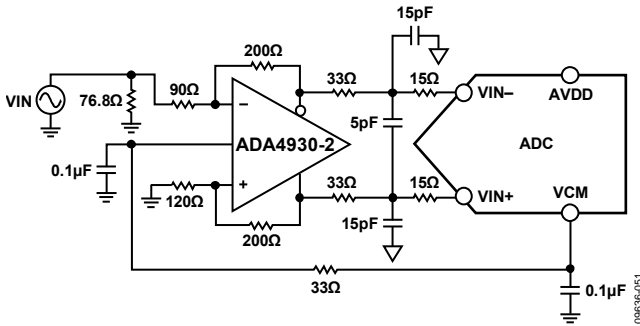

Figure 47. Differential Input Configuration Using the ADA4930-2

For baseband applications where SNR is a key parameter, differential transformer coupling is the recommended input configuration. An example is shown in Figure 48. To bias the analog input, the VCM voltage can be connected to the center tap of the secondary winding of the transformer.

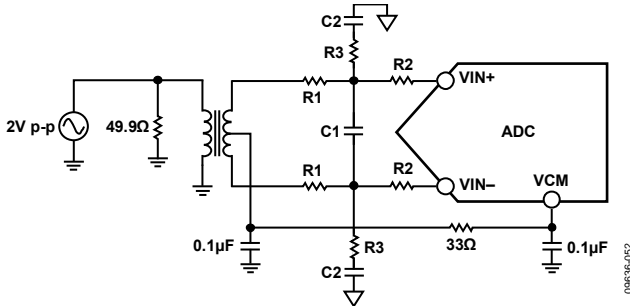

Figure 48. Differential Transformer-Coupled Configuration

The signal characteristics must be considered when selecting a transformer. Most RF transformers saturate at frequencies below a few megahertz. Excessive signal power can also cause core saturation, which leads to distortion.

At input frequencies in the second Nyquist zone and above, the noise performance of most amplifiers is not adequate to achieve the true SNR performance of the AD9643. For applications where SNR is a key parameter, differential double balun coupling is

the recommended input configuration (see Figure 50). In this configuration, the input is ac-coupled and the VCM voltage is provided to each input through a 33 Ω resistor. These resistors compensate for losses in the input baluns to provide a 50 Ω impedance to the driver.

In the double balun and transformer configurations, the value of the input capacitors and resistors is dependent on the input frequency and source impedance. Based on these parameters, the value of the input resistors and capacitors may need to be adjusted or some components may need to be removed. Table 10 displays recommended values to set the RC network for different input frequency ranges. However, these values are dependent on the input signal and bandwidth and should be used only as a starting guide. Note that the values given in Table 10 are for each R1, R2, C2, and R3 component shown in Figure 48 and Figure 50.

Table 10. Example RC Network

| Frequency Range (MHz) | R1 Series (Ω) | C1 Differential (pF) | R2 Series (Ω) | C2 Shunt (pF) | R3 Shunt (Ω) |
|-----------------------|---------------|----------------------|---------------|---------------|--------------|
| 0 to 100 | 33 | 8.2 | 0 | 15 | 49.9 |
| 100 to 300 | 15 | 3.9 | 0 | 8.2 | 49.9 |

An alternative to using a transformer-coupled input at frequencies in the second Nyquist zone is to use an amplifier with variable gain. The AD8375 or AD8376 digital variable gain amplifier (DVGAs) provides good performance for driving the AD9643. Figure 49 shows an example of the AD8376 driving the AD9643 through a band-pass antialiasing filter.

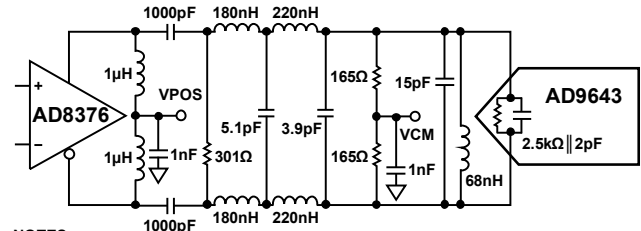

- NOTES
1. ALL INDUCTORS ARE COILCRAFT® 0603CS COMPONENTS WITH THE EXCEPTION OF THE 1μH CHOKE INDUCTORS (COIL CRAFT 0603LS).
 2. FILTER VALUES SHOWN ARE FOR A 20MHz BANDWIDTH FILTER CENTERED AT 140MHz.

Figure 49. Differential Input Configuration Using the AD8376

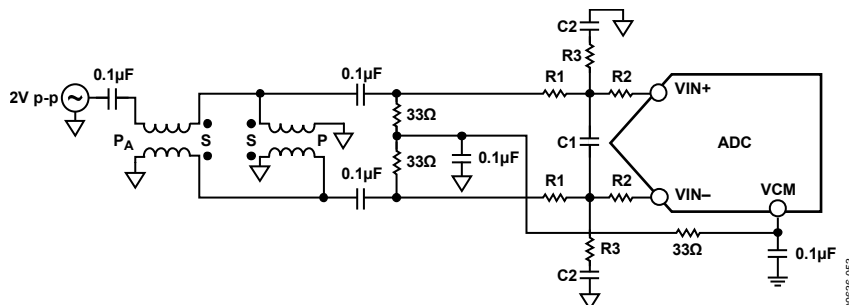

Figure 50. Differential Double Balun Input Configuration

VOLTAGE REFERENCE

A stable and accurate voltage reference is built into the AD9643. The full-scale input range can be adjusted by varying the reference voltage via SPI. The input span of the ADC tracks reference voltage changes linearly.

CLOCK INPUT CONSIDERATIONS

For optimum performance, the AD9643 sample clock inputs, CLK+ and CLK-, should be clocked with a differential signal. The signal is typically ac-coupled into the CLK+ and CLK- pins via a transformer or via capacitors. These pins are biased internally (see Figure 51) and require no external bias. If the inputs are floated, the CLK- pin is pulled low to prevent spurious clocking.

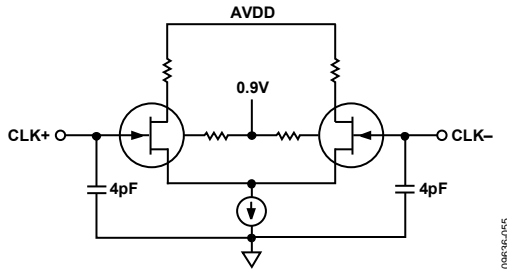

Figure 51. Simplified Equivalent Clock Input Circuit

Clock Input Options

The AD9643 has a very flexible clock input structure. Clock input can be a CMOS, LVDS, LVPECL, or sine wave signal. Regardless of the type of signal being used, clock source jitter is of the most concern, as described in the Jitter Considerations section.

Figure 52 and Figure 53 show two preferable methods for clocking the AD9643 (at clock rates of up to 625 MHz). A low jitter clock source is converted from a single-ended signal to a differential signal using an RF balun or RF transformer.

The RF balun configuration is recommended for clock frequencies between 125 MHz and 625 MHz, and the RF transformer is recommended for clock frequencies from 10 MHz to 200 MHz. The back-to-back Schottky diodes across the transformer secondary limit clock excursions into the AD9643 to approximately 0.8 V p-p differential. This limit helps prevent the large voltage swings of the clock from feeding through to other portions of the AD9643 while preserving the fast rise and fall times of the signal, which are critical to low jitter performance.

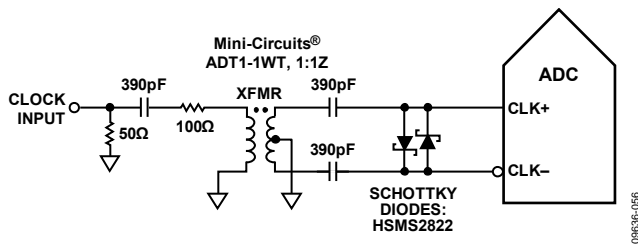

Figure 52. Transformer-Coupled Differential Clock (Up to 200 MHz)

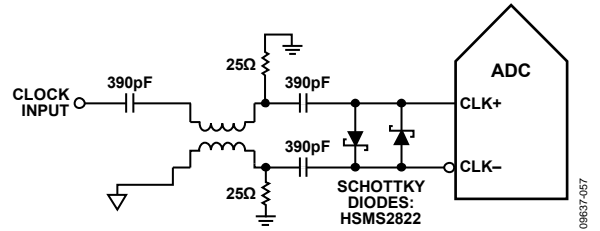

Figure 53. Balun-Coupled Differential Clock (Up to 625 MHz)

If a low jitter clock source is not available, another option is to ac-couple a differential PECL signal to the sample clock input pins as shown in Figure 54. The AD9510, AD9511, AD9512, AD9513, AD9514, AD9515, AD9516-0 to AD9516-5, AD9517-0 to AD9517-4, AD9518-0 to AD9518-4, AD9520-0 to AD9520-5, AD9522-0 to AD9522-5, AD9523, AD9524, and ADCLK905/ADCLK907/ADCLK925 clock drivers offer excellent jitter performance.

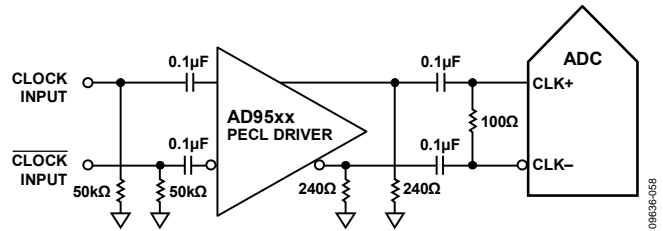

Figure 54. Differential PECL Sample Clock (Up to 625 MHz)

A third option is to ac-couple a differential LVDS signal to the sample clock input pins, as shown in Figure 55. The AD9510, AD9511, AD9512, AD9513, AD9514, AD9515, AD9516-0 to AD9516-5, AD9517-0 to AD9517-4, AD9518-0 to AD9518-4, AD9520-0 to AD9520-5, AD9522-0 to AD9522-5, AD9523, and AD9524 clock drivers offer excellent jitter performance.

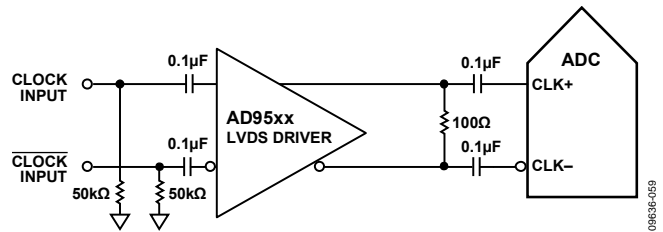

Figure 55. Differential LVDS Sample Clock (Up to 625 MHz)

Input Clock Divider

The AD9643 contains an input clock divider with the ability to divide the input clock by integer values between 1 and 8. The duty cycle stabilizer (DCS) is enabled by default on power-up.

The AD9643 clock divider can be synchronized using the external SYNC input. Bit 1 and Bit 2 of Register 0x3A allow the clock divider to be resynchronized on every SYNC signal or only on the first SYNC signal after the register is written. A valid SYNC causes the clock divider to reset to its initial state. This synchronization feature allows multiple parts to have their clock dividers aligned to guarantee simultaneous input sampling.

Clock Duty Cycle

Typical high speed ADCs use both clock edges to generate a variety of internal timing signals and, as a result, may be sensitive to clock duty cycle. Commonly, a $\pm 5\%$ tolerance is required on the clock duty cycle to maintain dynamic performance characteristics.

The AD9643 contains a duty cycle stabilizer (DCS) that retimes the nonsampling (falling) edge, providing an internal clock signal with a nominal 50% duty cycle. This allows the user to provide a wide range of clock input duty cycles without affecting the performance of the AD9643.

Jitter on the rising edge of the input clock is still of paramount concern and is not reduced by the duty cycle stabilizer. The duty cycle control loop does not function for clock rates less than 40 MHz nominally. The loop has a time constant associated with it that must be considered when the clock rate can change dynamically. A wait time of 1.5 μs to 5 μs is required after a dynamic clock frequency increase or decrease before the DCS loop is relocked to the input signal. During the time period that the loop is not locked, the DCS loop is bypassed, and internal device timing is dependent on the duty cycle of the input clock signal. In such applications, it may be appropriate to disable the duty cycle stabilizer. In all other applications, enabling the DCS circuit is recommended to maximize ac performance.

Jitter Considerations

High speed, high resolution ADCs are sensitive to the quality of the clock input. The degradation in SNR at a given input frequency (f_{IN}) due to jitter (t_j) can be calculated by

$$SNR_{HF} = -10 \log[(2\pi \times f_{IN} \times t_{jRMS})^2 + 10^{(-SNR_{LF}/10)}]$$

In the equation, the rms aperture jitter represents the root-mean-square of all jitter sources, which include the clock input, the analog input signal, and the ADC aperture jitter specification. IF undersampling applications are particularly sensitive to jitter, as shown in Figure 56.

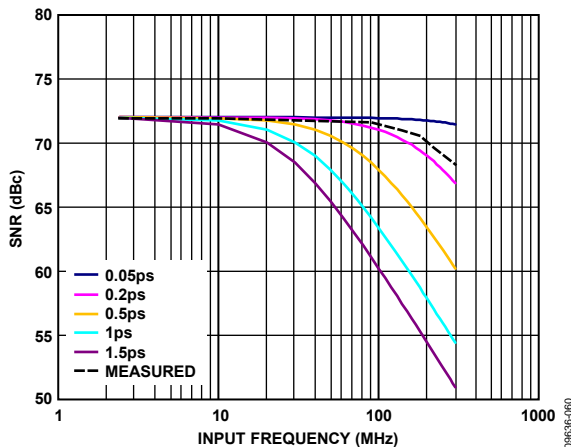

Figure 56. AD9643-250 SNR vs. Input Frequency and Jitter

The clock input should be treated as an analog signal in cases where aperture jitter may affect the dynamic range of the AD9643.

Power supplies for clock drivers should be separated from the ADC output driver supplies to avoid modulating the clock signal with digital noise. Low jitter, crystal controlled oscillators make the best clock sources. If the clock is generated from another type of source (by gating, dividing, or another method), it should be retimed by the original clock at the last step.

Refer to the AN-501 Application Note, *Aperture Uncertainty and ADC System Performance*, and the AN-756 Application Note, *Sampled Systems and the Effects of Clock Phase Noise and Jitter*, for more information about jitter performance as it relates to ADCs.

POWER DISSIPATION AND STANDBY MODE

As shown in Figure 57, the power dissipated by the AD9643 is proportional to its sample rate. The data in Figure 57 was taken using the same operating conditions as those used for the Typical Performance Characteristics section.

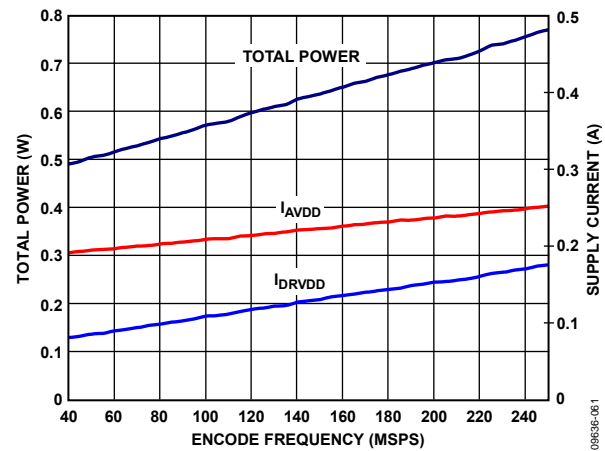

Figure 57. AD9643-250 Power and Current vs. Sample Rate

By asserting PDWN (either through the SPI port or by asserting the PDWN pin high), the AD9643 is placed in power-down mode. In this state, the ADC typically dissipates 10 mW. During power-down, the output drivers are placed in a high impedance state. Asserting the PDWN pin low returns the AD9643 to its normal operating mode. Note that PDWN is referenced to the digital output driver supply (DRVDD) and should not exceed that supply voltage.

Low power dissipation in power-down mode is achieved by shutting down the reference, reference buffer, biasing networks, and clock. Internal capacitors are discharged when entering power-down mode and then must be recharged when returning to normal operation. As a result, wake-up time is related to the time spent in power-down mode, and shorter power-down cycles result in proportionally shorter wake-up times.

When using the SPI port interface, the user can place the ADC in power-down mode or standby mode. Standby mode allows the user to keep the internal reference circuitry powered when faster wake-up times are required. See the Memory Map Register Description section and the AN-877 Application Note, *Interfacing to High Speed ADCs via SPI*, for additional details.

DIGITAL OUTPUTS

The AD9643 output drivers can be configured for either ANSI LVDS or reduced drive LVDS using a 1.8 V DRVDD supply.

As detailed in the [AN-877 Application Note, Interfacing to High Speed ADCs via SPI](#), the data format can be selected for offset binary, twos complement, or gray code when using the SPI control.

Digital Output Enable Function (OEB)

The AD9643 has a flexible three-state ability for the digital output pins. The three-state mode is enabled using the OEB pin or through the SPI interface. If the OEB pin is low, the output data drivers are enabled. If the OEB pin is high, the output data drivers are placed in a high impedance state. This OEB function is not intended for rapid access to the data bus. Note that OEB is referenced to the digital output driver supply (DRVDD) and should not exceed that supply voltage.

When using the SPI interface, the data outputs of each channel can be independently three-stated by using the output enable bar bit (Bit 4) in Register 0x14. Because the output data is interleaved, if only one of the two channels is disabled, the output data of the remaining channel is repeated in both the rising and falling output clock cycles.

Timing

The AD9643 provides latched data with a pipeline delay of 10 input sample clock cycles. Data outputs are available one propagation delay (t_{PD}) after the rising edge of the clock signal.

The length of the output data lines and loads placed on them should be minimized to reduce transients within the AD9643. These transients can degrade converter dynamic performance.

The lowest typical conversion rate of the AD9643 is 40 MSPS. At clock rates below 40 MSPS, dynamic performance may degrade.

Data Clock Output (DCO)

The AD9643 also provides data clock output (DCO) intended for capturing the data in an external register. Figure 2 shows a graphical timing diagram of the AD9643 output modes.

ADC OVERRANGE (OR)

The ADC overrange indicator is asserted when an overrange is detected on the input of the ADC. The overrange condition is determined at the output of the ADC pipeline and, therefore, is subject to a latency of 10 ADC clocks. An overrange at the input is indicated by this bit, 10 clock cycles after it occurs.

Table 11. Output Data Format

| Input (V) | VIN+ – VIN–, Input Span = 1.75 V p-p (V) | Offset Binary Output Mode | Twos Complement Mode (Default) | OR |
|-------------|---|---------------------------|--------------------------------|----|
| VIN+ – VIN– | <–0.875 | 00 0000 0000 0000 | 10 0000 0000 0000 | 1 |
| VIN+ – VIN– | –0.875 | 00 0000 0000 0000 | 10 0000 0000 0000 | 0 |
| VIN+ – VIN– | 0 | 10 0000 0000 0000 | 00 0000 0000 0000 | 0 |
| VIN+ – VIN– | +0.875 | 11 1111 1111 1111 | 01 1111 1111 1111 | 0 |
| VIN+ – VIN– | >+0.875 | 11 1111 1111 1111 | 01 1111 1111 1111 | 1 |

CHANNEL/CHIP SYNCHRONIZATION

The AD9643 has a SYNC input that allows the user flexible synchronization options for synchronizing the internal blocks. The SYNC feature is useful for guaranteeing synchronized operation across multiple ADCs. The input clock divider can be synchronized using the SYNC input. The divider can be enabled to synchronize on a single occurrence of the SYNC signal or on every occurrence by setting the appropriate bits in Register 0x3A.

The SYNC input is internally synchronized to the sample clock. However, to ensure that there is no timing uncertainty between multiple parts, the SYNC input signal should be synchronized to the input clock signal. The SYNC input should be driven using a single-ended CMOS type signal.

SERIAL PORT INTERFACE (SPI)

The AD9643 serial port interface (SPI) allows the user to configure the converter for specific functions or operations through a structured register space provided inside the ADC. The SPI gives the user added flexibility and customization, depending on the application. Addresses are accessed via the serial port and can be written to or read from via the port. Memory is organized into bytes that can be further divided into fields. These fields are documented in the Memory Map section. For detailed operational information, see the [AN-877 Application Note, *Interfacing to High Speed ADCs via SPI*](#).

CONFIGURATION USING THE SPI

Three pins define the SPI of this ADC: the SCLK pin, the SDIO pin, and the CSB pin (see Table 12). The SCLK (serial clock) pin is used to synchronize the read and write data presented from/to the ADC. The SDIO (serial data input/output) pin is a dual-purpose pin that allows data to be sent and read from the internal ADC memory map registers. The CSB (chip select bar) pin is an active low control that enables or disables the read and write cycles.

Table 12. Serial Port Interface Pins

| Pin | Function |
|------|---|
| SCLK | Serial Clock. The serial shift clock input, which is used to synchronize serial interface reads and writes. |
| SDIO | Serial Data Input/Output. A dual-purpose pin that typically serves as an input or an output, depending on the instruction being sent and the relative position in the timing frame. |
| CSB | Chip Select Bar. An active low control that gates the read and write cycles. |

The falling edge of CSB, in conjunction with the rising edge of SCLK, determines the start of the framing. An example of the serial timing and its definitions can be found in Figure 58 and Table 5.

Other modes involving the CSB are available. The CSB can be held low indefinitely, which permanently enables the device; this is called streaming. The CSB can stall high between bytes to allow for additional external timing. When CSB is tied high, SPI functions are placed in a high impedance mode. This mode turns on any SPI pin secondary functions.

During an instruction phase, a 16-bit instruction is transmitted. Data follows the instruction phase, and its length is determined by the W0 and the W1 bits.

All data is composed of 8-bit words. The first bit of each individual byte of serial data indicates whether a read or write command is issued. This allows the serial data input/output (SDIO) pin to change direction from an input to an output.

In addition to word length, the instruction phase determines whether the serial frame is a read or write operation, allowing the serial port to be used both to program the chip and to read the contents of the on-chip memory. If the instruction is a readback operation, performing a readback causes the serial data input/output (SDIO) pin to change direction from an input to an output at the appropriate point in the serial frame.

Data can be sent in MSB first mode or in LSB first mode. MSB first is the default on power-up and can be changed via the SPI port configuration register. For more information about this and other features, see the [AN-877 Application Note, *Interfacing to High Speed ADCs via SPI*](#).

HARDWARE INTERFACE

The pins described in Table 12 comprise the physical interface between the user programming device and the serial port of the AD9643. The SCLK pin and the CSB pin function as inputs when using the SPI interface. The SDIO pin is bidirectional, functioning as an input during write phases and as an output during readback.

The SPI interface is flexible enough to be controlled by either FPGAs or microcontrollers. One method for SPI configuration is described in detail in the [AN-812 Application Note, *Microcontroller-Based Serial Port Interface \(SPI\) Boot Circuit*](#).

The SPI port should not be active during periods when the full dynamic performance of the converter is required. Because the SCLK signal, the CSB signal, and the SDIO signal are typically asynchronous to the ADC clock, noise from these signals can degrade converter performance. If the on-board SPI bus is used for other devices, it may be necessary to provide buffers between this bus and the AD9643 to prevent these signals from transitioning at the converter inputs during critical sampling periods.

SPI ACCESSIBLE FEATURES

Table 13 provides a brief description of the general features that are accessible via the SPI. These features are described in detail in the [AN-877 Application Note, Interfacing to High Speed ADCs via SPI](#). The AD9643 part-specific features are described in the Memory Map Register Description section.

Table 13. Features Accessible Using the SPI

| Feature Name | Description |
|--------------|---|
| Mode | Allows the user to set either power-down mode or standby mode |
| Clock | Allows the user to access the DCS via the SPI |
| Offset | Allows the user to digitally adjust the converter offset |
| Test I/O | Allows the user to set test modes to have known data on output bits |
| Output Mode | Allows the user to set up outputs |
| Output Phase | Allows the user to set the output clock polarity |
| Output Delay | Allows the user to vary the DCO delay |
| VREF | Allows the user to set the reference voltage |

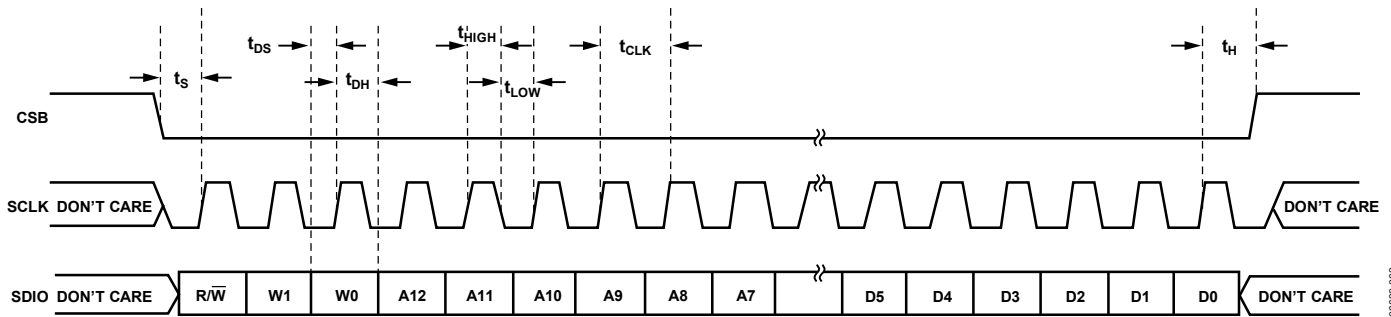

Figure 58. Serial Port Interface Timing Diagram

09636-062

MEMORY MAP

READING THE MEMORY MAP REGISTER TABLE

Each row in the memory map register table has eight bit locations. The memory map is roughly divided into three sections: the chip configuration registers (Address 0x00 to Address 0x02); the channel index and transfer registers (Address 0x05 and Address 0xFF); and the ADC functions registers, including setup, control, and test (Address 0x08 to Address 0x3A).

The memory map register table (see Table 14) documents the default hexadecimal value for each hexadecimal address shown. The column with the heading Bit 7 (MSB) is the start of the default hexadecimal value given. For example, Address 0x14, the output mode register, has a hexadecimal default value of 0x05. This means that Bit 0 = 1 and Bit 2 = 1, and the remaining bits are 0s. This setting is the default output format value, which is twos complement. For more information on this function and others, see the [AN-877 Application Note, Interfacing to High Speed ADCs via SPI](#). This document details the functions controlled by Register 0x00 to Register 0x20. The remaining registers, Register 0x3A, is documented in the Memory Map Register Description section.

Open and Reserved Locations

All address and bit locations that are not included in Table 14 are not currently supported for this device. Unused bits of a valid address location should be written with 0s. Writing to these locations is required only when part of an address location is open (for example, Address 0x18). If the entire address location is open (for example, Address 0x13), this address location should not be written.

Default Values

After the [AD9643](#) is reset, critical registers are loaded with default values. The default values for the registers are given in the memory map register table, Table 14.

Logic Levels

An explanation of logic level terminology follows:

- “Bit is set” is synonymous with “bit is set to Logic 1” or “writing Logic 1 for the bit.”
- “Clear a bit” is synonymous with “bit is set to Logic 0” or “writing Logic 0 for the bit.”

Transfer Register Map

Address 0x08 to Address 0x20 and Address 0x3A are shadowed. Writes to these addresses do not affect part operation until a transfer command is issued by writing 0x01 to Address 0xFF, setting the transfer bit. This allows these registers to be updated internally and simultaneously when the transfer bit is set. The internal update takes place when the transfer bit is set, and then the bit autoclears.

Channel-Specific Registers

Some channel setup functions, such as the signal monitor thresholds, can be programmed to a different value for each channel. In these cases, channel address locations are internally duplicated for each channel. These registers and bits are designated in Table 14 as local. These local registers and bits can be accessed by setting the appropriate Channel A or Channel B bits in Register 0x05. If both bits are set, the subsequent write affects the registers of both channels. In a read cycle, only Channel A or Channel B should be set to read one of the two registers. If both bits are set during an SPI read cycle, the part returns the value for Channel A. Registers and bits designated as global in Table 14 affect the entire part and the channel features for which independent settings are not allowed between channels. The settings in Register 0x05 do not affect the global registers and bits.

MEMORY MAP REGISTER TABLE

All address and bit locations that are not included in Table 14 are not currently supported for this device.

Table 14. Memory Map Registers

| Addr (Hex) | Register Name | Bit 7 (MSB) | Bit 6 | Bit 5 | Bit 4 | Bit 3 | Bit 2 | Bit 1 | Bit 0 (LSB) | Default Value (Hex) | Default Notes/Comments |
|--------------------------------------|--|--|-----------|---|-------|-------|--|--|---------------------------------|---------------------|--|
| Chip Configuration Registers | | | | | | | | | | | |
| 0x00 | SPI port configuration (global) ¹ | 0 | LSB first | Soft reset | 1 | 1 | Soft reset | LSB first | 0 | 0x18 | The nibbles are mirrored so that LSB first mode or MSB first mode registers correctly, regardless of shift mode. |
| 0x01 | Chip ID (global) | 8-bit chip ID[7:0] (AD9643 = 0x82) (default) | | | | | | | | 0x82 | Read only. |
| 0x02 | Chip grade (global) | Open | Open | Speed grade ID 00 = 250 MSPS 01 = 210 MSPS 11 = 170 MSPS | Open | Open | Open | Open | Open | | Speed grade ID used to differentiate devices; read only. |
| Channel Index and Transfer Registers | | | | | | | | | | | |
| 0x05 | Channel index (global) | Open | Open | Open | Open | Open | Open | ADC B (default) | ADC A (default) | 0x03 | Bits are set to determine which device on the chip receives the next write command; applies to local registers only. |
| 0xFF | Transfer (global) | Open | Open | Open | Open | Open | Open | Open | Transfer | 0x00 | Synchronously transfers data from the master shift register to the slave. |
| ADC Functions | | | | | | | | | | | |
| 0x08 | Power modes (local) | Open | Open | External power-down pin function (local) 0 = power-down 1 = standby | Open | Open | Open | Internal power-down mode (local) 00 = normal operation 01 = full power-down 10 = standby 11 = reserved | | 0x00 | Determines various generic modes of chip operation. |
| 0x09 | Global clock (global) | Open | Open | Open | Open | Open | Open | Open | Duty cycle stabilizer (default) | 0x01 | |
| 0x0B | Clock divide (global) | Open | Open | Input clock divider phase adjust 000 = no delay 001 = 1 input clock cycle 010 = 2 input clock cycles 011 = 3 input clock cycles 100 = 4 input clock cycles 101 = 5 input clock cycles 110 = 6 input clock cycles 111 = 7 input clock cycles | | | Clock divide ratio 000 = divide by 1 001 = divide by 2 010 = divide by 3 011 = divide by 4 100 = divide by 5 101 = divide by 6 110 = divide by 7 111 = divide by 8 | | | 0x00 | Clock divide values other than 000 automatically cause the duty cycle stabilizer to become active. |

| Addr (Hex) | Register Name | Bit 7 (MSB) | Bit 6 | Bit 5 | Bit 4 | Bit 3 | Bit 2 | Bit 1 | Bit 0 (LSB) | Default Value (Hex) | Default Notes/Comments |
|------------|----------------------------------|--|-------|--|--|---|--|--|-------------|---|--|
| 0x0D | Test mode (local) | User test mode control 0 = continuous/repeat pattern 1 = single pattern, then 0s | Open | Reset PN long gen | Reset PN short gen | | Output test mode 0000 = off (default) 0001 = midscale short 0010 = positive FS 0011 = negative FS 0100 = alternating checkerboard 0101 = PN long sequence 0110 = PN short sequence 0111 = one/zero word toggle 1000 = user test mode 1001 to 1110 = unused 1111 = ramp output | | | 0x00 | When this register is set, the test data is placed on the output pins in place of normal data. |
| 0x10 | Offset adjust (local) | Open | Open | Offset adjust in LSBs from +31 to -32 (twos complement format) | | | | | | 0x00 | |
| 0x14 | Output mode | Open | Open | Open | Output enable bar (local) | Open | Output invert (local) 1 = normal (default) 0 = inverted | Output format 00 = offset binary 01 = twos complement (default) 10 = gray code 11 = reserved (local) | | 0x05 | Configures the outputs and the format of the data. |
| 0x15 | Output Adjust (Global) | Open | Open | Open | Open | LVDS output drive current adjust 0000 = 3.72 mA output drive current 0001 = 3.5 mA output drive current (default) 0010 = 3.30 mA output drive current 0011 = 2.96 mA output drive current 0100 = 2.82 mA output drive current 0101 = 2.57 mA output drive current 0110 = 2.27 mA output drive current 0111 = 2.0 mA output drive current (reduced range) 1000 to 1111 = reserved | | | | 0x01 | |
| 0x16 | Clock phase control (global) | Invert DCO clock | Open | Even/odd mode output enable 0 = disabled 1 = enabled | Open | Open | Open | Open | Open | 0x00 | |
| 0x17 | DCO output delay (global) | Enable DCO clock delay | Open | Open | DCO clock delay [delay = (3100 ps × register value/31 + 100)] 00000 = 100 ps 00001 = 200 ps 00010 = 300 ps ... 11110 = 3100 ps 11111 = 3200 ps | | | | 0x00 | | |
| 0x18 | Input Span select (global) | Open | Open | Open | Full-scale input voltage selection 01111 = 2.087 V p-p ... 00001 = 1.772 V p-p 00000 = 1.75 V p-p (default) 11111 = 1.727 V p-p ... 10000 = 1.383 V p-p | | | | 0x00 | Full-scale input adjustment in 0.022 V steps. | |
| 0x19 | User Test Pattern 1 LSB (global) | User Test Pattern 1[7:0] | | | | | | | | 0x00 | |
| 0x1A | User Test Pattern 1 MSB (global) | User Test Pattern 1[15:8] | | | | | | | | 0x00 | |
| 0x1B | User Test Pattern 2 LSB (global) | User Test Pattern 2[7:0] | | | | | | | | 0x00 | |
| 0x1C | User Test Pattern 2 MSB (global) | User Test Pattern 2[15:8] | | | | | | | | 0x00 | |

| Addr (Hex) | Register Name | Bit 7 (MSB) | Bit 6 | Bit 5 | Bit 4 | Bit 3 | Bit 2 | Bit 1 | Bit 0 (LSB) | Default Value (Hex) | Default Notes/Comments |
|------------|----------------------------------|---------------------------|-------|-------|-------|-------|------------------------------|---------------------------|---------------------------|---------------------|------------------------|
| 0x1D | User Test Pattern 3 LSB (global) | User Test Pattern 3[7:0] | | | | | | | | 0x00 | |
| 0x1E | User Test Pattern 3 MSB (global) | User Test Pattern 3[15:8] | | | | | | | | 0x00 | |
| 0x1F | User Test Pattern 4 LSB (global) | User Test Pattern 4[7:0] | | | | | | | | 0x00 | |
| 0x20 | User Test Pattern 4 MSB (global) | User Test Pattern 4[15:8] | | | | | | | | 0x00 | |
| 0x3A | Sync control (global) | Open | Open | Open | Open | Open | Clock divider next sync only | Clock divider sync enable | Master sync buffer enable | 0x00 | |

¹ The channel index register at Address 0x05 should be set to 0x03 (default) when writing to Address 0x00.

MEMORY MAP REGISTER DESCRIPTION

For more information on functions controlled in Register 0x00 to Register 0x20, see the [AN-877 Application Note, Interfacing to High Speed ADCs via SPI](#).

Sync Control (Register 0x3A)

Bits[7:3]—Reserved

Bit 2—Clock Divider Next Sync Only

If the master sync buffer enable bit (Address 0x3A, Bit 0) and the clock divider sync enable bit (Address 0x3A, Bit 1) are high, Bit 2 allows the clock divider to sync to the first sync pulse that it receives and to ignore the rest. The clock divider sync enable bit (Address 0x3A, Bit 1) resets after it syncs.

Bit 1—Clock Divider Sync Enable

Bit 1 gates the sync pulse to the clock divider. The sync signal is enabled when Bit 1 is high and Bit 0 is high. This is continuous sync mode.

Bit 0—Master Sync Buffer Enable

Bit 0 must be set high to enable any of the sync functions. If the sync capability is not used, this bit should remain low to conserve power.

APPLICATIONS INFORMATION

DESIGN GUIDELINES

Before starting system level design and layout of the [AD9643](#), it is recommended that the designer become familiar with these guidelines, which discuss the special circuit connections and layout requirements needed for certain pins.

Power and Ground Recommendations

When connecting power to the [AD9643](#), it is recommended that two separate 1.8 V supplies be used: one supply should be used for analog (AVDD), and a separate supply should be used for the digital outputs (DRVDD). The designer can employ several different decoupling capacitors to cover both high and low frequencies. These capacitors should be located close to the point of entry at the PC board level and close to the pins of the part with minimal trace length.

A single PCB ground plane should be sufficient when using the [AD9643](#). With proper decoupling and smart partitioning of the PCB analog, digital, and clock sections, optimum performance is easily achieved.

Exposed Paddle Thermal Heat Slug Recommendations

It is mandatory that the exposed paddle on the underside of the ADC be connected to analog ground (AGND) to achieve the best electrical and thermal performance. A continuous, exposed (no solder mask) copper plane on the PCB should mate to the [AD9643](#) exposed paddle, Pin 0.

The copper plane should have several vias to achieve the lowest possible resistive thermal path for heat dissipation to flow through the bottom of the PCB. These vias should be filled or plugged with nonconductive epoxy.

To maximize the coverage and adhesion between the ADC and the PCB, a silkscreen should be overlaid to partition the continuous plane on the PCB into several uniform sections. This provides several tie points between the ADC and the PCB during the reflow process. Using one continuous plane with no partitions guarantees only one tie point between the ADC and the PCB. See the evaluation board for a PCB layout example. For detailed information about the packaging and PCB layout of chip scale packages, refer to the [AN-772 Application Note, A Design and Manufacturing Guide for the Lead Frame Chip Scale Package \(LFCSP\)](#).

VCM

The VCM pin should be decoupled to ground with a 0.1 μF capacitor, as shown in Figure 48. For optimal channel-to-channel isolation, a 33 Ω resistor should be included between the [AD9643](#) VCM pin and the Channel A analog input network connection, as well as between the [AD9643](#) VCM pin and the Channel B analog input network connection.

SPI Port

The SPI port should not be active during periods when the full dynamic performance of the converter is required. Because the SCLK, CSB, and SDIO signals are typically asynchronous to the ADC clock, noise from these signals can degrade converter performance. If the on-board SPI bus is used for other devices, it may be necessary to provide buffers between this bus and the [AD9643](#) to keep these signals from transitioning at the converter input pins during critical sampling periods.

OUTLINE DIMENSIONS

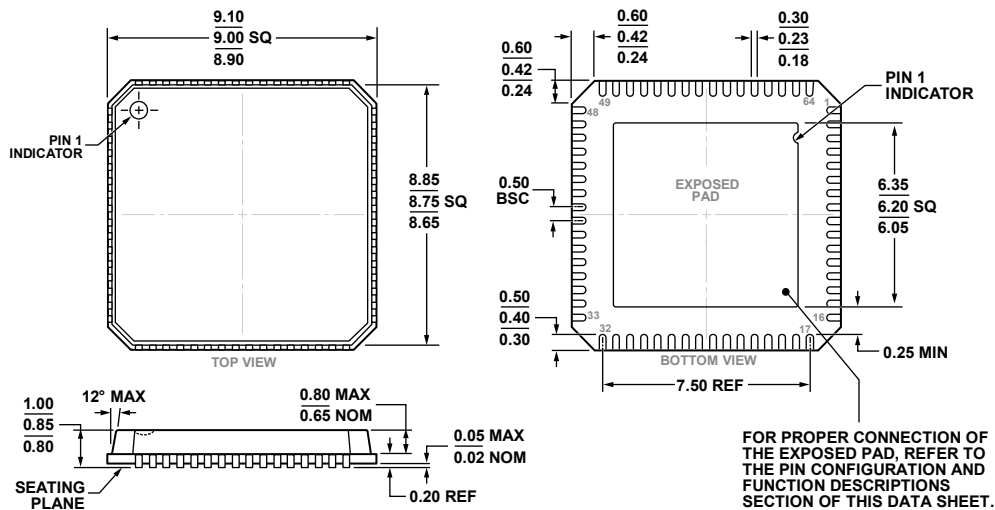

COMPLIANT TO JEDEC STANDARDS MO-220-VMM4

Figure 59. 64-Lead Lead Frame Chip Scale Package [LFCSP_VQ]
9 mm × 9 mm Body, Very Thin Quad
(CP-64-4)

Dimensions shown in millimeters

ORDERING GUIDE

| Model ¹ | Temperature Range | Package Description | Package Option |
|--------------------|-------------------|--|----------------|
| AD9643BCPZ-170 | -40°C to +85°C | 64-Lead Lead Frame Chip Scale Package [LFCSP_VQ] | CP-64-4 |
| AD9643BCPZ-210 | -40°C to +85°C | 64-Lead Lead Frame Chip Scale Package [LFCSP_VQ] | CP-64-4 |
| AD9643BCPZ-250 | -40°C to +85°C | 64-Lead Lead Frame Chip Scale Package [LFCSP_VQ] | CP-64-4 |
| AD9643BCPZRL7-170 | -40°C to +85°C | 64-Lead Lead Frame Chip Scale Package [LFCSP_VQ] | CP-64-4 |
| AD9643BCPZRL7-210 | -40°C to +85°C | 64-Lead Lead Frame Chip Scale Package [LFCSP_VQ] | CP-64-4 |
| AD9643BCPZRL7-250 | -40°C to +85°C | 64-Lead Lead Frame Chip Scale Package [LFCSP_VQ] | CP-64-4 |
| AD9643-250EBZ | -40°C to +85°C | Evaluation Board with AD9643-250 | |

¹ Z = RoHS Compliant Part.

Компания «Океан Электроники» предлагает заключение долгосрочных отношений при поставках импортных электронных компонентов на взаимовыгодных условиях!

Наши преимущества:

- Поставка оригинальных импортных электронных компонентов напрямую с производств Америки, Европы и Азии, а так же с крупнейших складов мира;
- Широкая линейка поставок активных и пассивных импортных электронных компонентов (более 30 млн. наименований);
- Поставка сложных, дефицитных, либо снятых с производства позиций;
- Оперативные сроки поставки под заказ (от 5 рабочих дней);
- Экспресс доставка в любую точку России;
- Помощь Конструкторского Отдела и консультации квалифицированных инженеров;
- Техническая поддержка проекта, помощь в подборе аналогов, поставка прототипов;
- Поставка электронных компонентов под контролем ВП;
- Система менеджмента качества сертифицирована по Международному стандарту ISO 9001;
- При необходимости вся продукция военного и аэрокосмического назначения проходит испытания и сертификацию в лаборатории (по согласованию с заказчиком);
- Поставка специализированных компонентов военного и аэрокосмического уровня качества (Xilinx, Altera, Analog Devices, Intersil, Interpoint, Microsemi, Actel, Aeroflex, Peregrine, VPT, Syfer, Eurofarad, Texas Instruments, MS Kennedy, Miteq, Cobham, E2V, MA-COM, Hittite, Mini-Circuits, General Dynamics и др.);

Компания «Океан Электроники» является официальным дистрибьютором и эксклюзивным представителем в России одного из крупнейших производителей разъемов военного и аэрокосмического назначения «JONHON», а так же официальным дистрибьютором и эксклюзивным представителем в России производителя высокотехнологичных и надежных решений для передачи СВЧ сигналов «FORSTAR».



JONHON

«JONHON» (основан в 1970 г.)

Разъемы специального, военного и аэрокосмического назначения:

(Применяются в военной, авиационной, аэрокосмической, морской, железнодорожной, горно- и нефтедобывающей отраслях промышленности)

«FORSTAR» (основан в 1998 г.)

ВЧ соединители, коаксиальные кабели, кабельные сборки и микроволновые компоненты:

(Применяются в телекоммуникациях гражданского и специального назначения, в средствах связи, РЛС, а так же военной, авиационной и аэрокосмической отраслях промышленности).



Телефон: 8 (812) 309-75-97 (многоканальный)

Факс: 8 (812) 320-03-32

Электронная почта: ocean@oceanchips.ru

Web: <http://oceanchips.ru/>

Адрес: 198099, г. Санкт-Петербург, ул. Калинина, д. 2, корп. 4, лит. А