

## 7/8-Bit Single/Dual I<sup>2</sup>C Digital POT with Nonvolatile Memory

### Features

- Single or Dual Resistor Network Options
- Potentiometer or Rheostat Configuration Options
- Resistor Network Resolution
  - 7-bit: 128 Resistors (129 Steps)
  - 8-bit: 256 Resistors (257 Steps)
- R<sub>AB</sub> Resistances Options of:
  - 5 kΩ
  - 10 kΩ
  - 50 kΩ
  - 100 kΩ
- Zero-Scale to Full-Scale Wiper Operation
- Low Wiper Resistance: 75Ω (typical)
- Low Tempco:
  - Absolute (Rheostat): 50 ppm typical (0°C to 70°C)
  - Ratiometric (Potentiometer): 15 ppm typical
- Nonvolatile Memory
  - Automatic Recall of Saved Wiper Setting
  - WiperLock™ Technology
  - 10 General Purpose Memory Locations
- I<sup>2</sup>C Serial Interface
  - 100 kHz, 400 kHz and 3.4 MHz Support
- Serial Protocol Allows:
  - High-Speed Read/Write to Wiper
  - Read/Write to EEPROM
  - Write Protect to be Enabled/Disabled
  - WiperLock to be Enabled/Disabled
- Resistor Network Terminal Disconnect Feature via the Terminal Control (TCON) Register
- Write Protect Feature:
  - Hardware Write Protect (WP) Control Pin
  - Software Write Protect (WP) Configuration Bit
- Brown-out Reset Protection (1.5V typical)
- Serial Interface Inactive Current (2.5 uA typical)
- High-Voltage Tolerant Digital Inputs: Up to 12.5V
- Wide Operating Voltage:
  - 2.7V to 5.5V - Device Characteristics Specified
  - 1.8V to 5.5V - Device Operation
- Wide Bandwidth (-3dB) Operation:
  - 2 MHz (typ.) for 5.0 kΩ Device
- Extended Temperature Range (-40°C to +125°C)

### Description

The MCP45XX and MCP46XX devices offer a wide range of product offerings using an I<sup>2</sup>C interface. This family of devices support 7-bit and 8-bit resistor networks, nonvolatile memory configurations, and Potentiometer and Rheostat pinouts.

WiperLock Technology allows application-specific calibration settings to be secured in the EEPROM.

### Package Types (top view)



# MCP454X/456X/464X/466X

## Device Block Diagram



## Device Features

Device	# of POTs	Wiper Configuration	Control Interface	Memory Type	WiperLock Technology	POR Wiper Setting	Resistance (typical)		# of Steps	V <sub>DD</sub> Operating Range <sup>(2)</sup>
							R <sub>AB</sub> Options (kΩ)	Wiper - R <sub>W</sub> (Ω)		
MCP4531 <sup>(3)</sup>	1	Potentiometer <sup>(1)</sup>	I <sup>2</sup> C	RAM	No	Mid-Scale	5.0, 10.0, 50.0, 100.0	75	129	1.8V to 5.5V
MCP4532 <sup>(3)</sup>	1	Rheostat	I <sup>2</sup> C	RAM	No	Mid-Scale	5.0, 10.0, 50.0, 100.0	75	129	1.8V to 5.5V
MCP4541	1	Potentiometer <sup>(1)</sup>	I <sup>2</sup> C	EE	Yes	NV Wiper	5.0, 10.0, 50.0, 100.0	75	129	2.7V to 5.5V
MCP4542	1	Rheostat	I <sup>2</sup> C	EE	Yes	NV Wiper	5.0, 10.0, 50.0, 100.0	75	129	2.7V to 5.5V
MCP4551 <sup>(3)</sup>	1	Potentiometer <sup>(1)</sup>	I <sup>2</sup> C	RAM	No	Mid-Scale	5.0, 10.0, 50.0, 100.0	75	257	1.8V to 5.5V
MCP4552 <sup>(3)</sup>	1	Rheostat	I <sup>2</sup> C	RAM	No	Mid-Scale	5.0, 10.0, 50.0, 100.0	75	257	1.8V to 5.5V
MCP4561	1	Potentiometer <sup>(1)</sup>	I <sup>2</sup> C	EE	Yes	NV Wiper	5.0, 10.0, 50.0, 100.0	75	257	2.7V to 5.5V
MCP4562	1	Rheostat	I <sup>2</sup> C	EE	Yes	NV Wiper	5.0, 10.0, 50.0, 100.0	75	257	2.7V to 5.5V
MCP4631 <sup>(3)</sup>	2	Potentiometer <sup>(1)</sup>	I <sup>2</sup> C	RAM	No	Mid-Scale	5.0, 10.0, 50.0, 100.0	75	129	1.8V to 5.5V
MCP4632 <sup>(3)</sup>	2	Rheostat	I <sup>2</sup> C	RAM	No	Mid-Scale	5.0, 10.0, 50.0, 100.0	75	129	1.8V to 5.5V
MCP4641	2	Potentiometer <sup>(1)</sup>	I <sup>2</sup> C	EE	Yes	NV Wiper	5.0, 10.0, 50.0, 100.0	75	129	2.7V to 5.5V
MCP4642	2	Rheostat	I <sup>2</sup> C	EE	Yes	NV Wiper	5.0, 10.0, 50.0, 100.0	75	129	2.7V to 5.5V
MCP4651 <sup>(3)</sup>	2	Potentiometer <sup>(1)</sup>	I <sup>2</sup> C	RAM	No	Mid-Scale	5.0, 10.0, 50.0, 100.0	75	257	1.8V to 5.5V
MCP4652 <sup>(3)</sup>	2	Rheostat	I <sup>2</sup> C	RAM	No	Mid-Scale	5.0, 10.0, 50.0, 100.0	75	257	1.8V to 5.5V
MCP4661	2	Potentiometer <sup>(1)</sup>	I <sup>2</sup> C	EE	Yes	NV Wiper	5.0, 10.0, 50.0, 100.0	75	257	2.7V to 5.5V
MCP4662	2	Rheostat	I <sup>2</sup> C	EE	Yes	NV Wiper	5.0, 10.0, 50.0, 100.0	75	257	2.7V to 5.5V

**Note 1:** Floating either terminal (A or B) allows the device to be used as a Rheostat (variable resistor).

**Note 2:** Analog characteristics only tested from 2.7V to 5.5V unless otherwise noted.

**Note 3:** Please check Microchip web site for device release and availability

# MCP454X/456X/464X/466X

## 1.0 ELECTRICAL CHARACTERISTICS

### 1.1 Absolute Maximum Ratings†

Voltage on $V_{DD}$ with respect to $V_{SS}$ .....	-0.6V to +7.0V
Voltage on HVC/A0, A1, A2, SCL, SDA and $\overline{WP}$ with respect to $V_{SS}$ .....	-0.6V to 12.5V
Voltage on all other pins (PxA, PxW, and PxB) with respect to $V_{SS}$ .....	-0.3V to $V_{DD} + 0.3V$
Input clamp current, $I_{IK}$ ( $V_I < 0$ , $V_I > V_{DD}$ , $V_I > V_{PP}$ ON HV pins).....	$\pm 20$ mA
Output clamp current, $I_{OK}$ ( $V_O < 0$ or $V_O > V_{DD}$ ) .....	$\pm 20$ mA
Maximum output current sunk by any Output pin.....	25 mA
Maximum output current sourced by any Output pin .....	25 mA
Maximum current out of $V_{SS}$ pin .....	100 mA
Maximum current into $V_{DD}$ pin .....	100 mA
Maximum current into PxA, PxW & PxB pins .....	$\pm 2.5$ mA
Storage temperature .....	-65°C to +150°C
Ambient temperature with power applied.....	-40°C to +125°C
Package power dissipation ( $T_A = +50^\circ\text{C}$ , $T_J = +150^\circ\text{C}$ )	
MSSOP-8 .....	473 mW
MSSOP-10.....	495 mW
DFN-8 (3x3) .....	1.76W
DFN-10 (3x3) .....	1.87W
TSSOP-14.....	1.00W
QFN-16 (4x4) .....	2.18W
Soldering temperature of leads (10 seconds) .....	+300°C
ESD protection on all pins .....	$\geq 4$ kV (HBM), $\geq 300$ V (MM)
Maximum Junction Temperature ( $T_J$ ) .....	+150°C

† **Notice:** Stresses above those listed under “Maximum Ratings” may cause permanent damage to the device. This is a stress rating only and functional operation of the device at those or any other conditions above those indicated in the operational listings of this specification is not implied. Exposure to maximum rating conditions for extended periods may affect device reliability.

# MCP454X/456X/464X/466X

## AC/DC CHARACTERISTICS

DC Characteristics		Standard Operating Conditions (unless otherwise specified) Operating Temperature $-40^{\circ}\text{C} \leq T_A \leq +125^{\circ}\text{C}$ (extended) All parameters apply across the specified operating ranges unless noted. $V_{DD} = +2.7\text{V}$ to $5.5\text{V}$ , $5\text{ k}\Omega$ , $10\text{ k}\Omega$ , $50\text{ k}\Omega$ , $100\text{ k}\Omega$ devices. Typical specifications represent values for $V_{DD} = 5.5\text{V}$ , $T_A = +25^{\circ}\text{C}$ .				
Parameters	Sym	Min	Typ	Max	Units	Conditions
Supply Voltage	$V_{DD}$	2.7	—	5.5	V	
		1.8	—	2.7	V	Serial Interface only.
HVC pin voltage range	$V_{HV}$	$V_{SS}$	—	12.5V	V	$V_{DD} \geq 4.5\text{V}$ $V_{DD} < 4.5\text{V}$ The HVC pin will be at one of three input levels ( $V_{IL}$ , $V_{IH}$ or $V_{IHH}$ ). (Note 6)
		$V_{SS}$	—	$V_{DD} + 8.0\text{V}$	V	
VDD Start Voltage to ensure Wiper Reset	$V_{BOR}$	—	—	1.65	V	RAM retention voltage ( $V_{RAM}$ ) $< V_{BOR}$
VDD Rise Rate to ensure Power-on Reset	$V_{DDRR}$	(Note 9)			V/ms	
Delay after device exits the reset state ( $V_{DD} > V_{BOR}$ )	$T_{BORD}$	—	10	20	$\mu\text{s}$	
Supply Current (Note 10)	$I_{DD}$	—	—	600	$\mu\text{A}$	Serial Interface Active, HVC/A0 = $V_{IH}$ (or $V_{IL}$ ) (Note 11) Write all 0's to Volatile Wiper 0 $V_{DD} = 5.5\text{V}$ , $F_{SCL} = 3.4\text{ MHz}$
		—	—	250	$\mu\text{A}$	Serial Interface Active, HVC/A0 = $V_{IH}$ (or $V_{IL}$ ) (Note 11) Write all 0's to Volatile Wiper 0 $V_{DD} = 5.5\text{V}$ , $F_{SCL} = 100\text{ kHz}$
		—	—	575	$\mu\text{A}$	EE Write Current (Write Cycle) (Nonvolatile device only), $V_{DD} = 5.5\text{V}$ , $F_{SCL} = 400\text{ kHz}$ , Write all 0's to Nonvolatile Wiper 0 $SCL = V_{IL}$ or $V_{IH}$
		—	2.5	5	$\mu\text{A}$	Serial Interface Inactive, (Stop condition, $SCL = SDA = V_{IH}$ ), Wiper = 0 $V_{DD} = 5.5\text{V}$ , HVC/A0 = $V_{IH}$

- Note 1:** Resistance is defined as the resistance between terminal A to terminal B.
- 2:** INL and DNL are measured at  $V_W$  with  $V_A = V_{DD}$  and  $V_B = V_{SS}$ .
- 3:** MCP4XX1 only.
- 4:** MCP4XX2 only, includes  $V_{WZSE}$  and  $V_{WFSE}$ .
- 5:** Resistor terminals A, W and B's polarity with respect to each other is not restricted.
- 6:** This specification by design.
- 7:** Non-linearity is affected by wiper resistance ( $R_W$ ), which changes significantly overvoltage and temperature.
- 8:** The MCP4XX1 is externally connected to match the configurations of the MCP45X2 and MCP46X2, and then tested.
- 9:** POR/BOR is not rate dependent.
- 10:** Supply current is independent of current through the resistor network.
- 11:** When HVC/A0 =  $V_{IHH}$ , the  $I_{DD}$  current is less due to current into the HVC/A0 pin. See  $I_{PU}$  specification.

# MCP454X/456X/464X/466X

## AC/DC CHARACTERISTICS (CONTINUED)

DC Characteristics		Standard Operating Conditions (unless otherwise specified)				
		Operating Temperature $-40^{\circ}\text{C} \leq T_A \leq +125^{\circ}\text{C}$ (extended)				
		All parameters apply across the specified operating ranges unless noted.				
		$V_{DD} = +2.7\text{V}$ to $5.5\text{V}$ , $5\text{ k}\Omega$ , $10\text{ k}\Omega$ , $50\text{ k}\Omega$ , $100\text{ k}\Omega$ devices.				
		Typical specifications represent values for $V_{DD} = 5.5\text{V}$ , $T_A = +25^{\circ}\text{C}$ .				
Parameters	Sym	Min	Typ	Max	Units	Conditions
Resistance ( $\pm 20\%$ )	$R_{AB}$	4.0	5	6.0	$\text{k}\Omega$	-502 devices ( <b>Note 1</b> )
		8.0	10	12.0	$\text{k}\Omega$	-103 devices ( <b>Note 1</b> )
		40.0	50	60.0	$\text{k}\Omega$	-503 devices ( <b>Note 1</b> )
		80.0	100	120.0	$\text{k}\Omega$	-104 devices ( <b>Note 1</b> )
Resolution	N	257			Taps	8-bit No Missing Codes
		129			Taps	7-bit No Missing Codes
Step Resistance	$R_S$	—	$R_{AB} / (256)$	—	$\Omega$	8-bit <b>Note 6</b>
		—	$R_{AB} / (128)$	—	$\Omega$	7-bit <b>Note 6</b>
Nominal Resistance Match	$ R_{AB0} - R_{AB1}  / R_{AB}$	—	0.2	1.25	%	<b>MCP46X1</b> devices only
	$ R_{BW0} - R_{BW1}  / R_{BW}$	—	0.25	1.5	%	<b>MCP46X2</b> devices only, Code = Full-Scale
Wiper Resistance ( <b>Note 3, Note 4</b> )	$R_W$	—	75	160	$\Omega$	$V_{DD} = 5.5\text{ V}$ , $I_W = 2.0\text{ mA}$ , code = 00h
		—	75	300	$\Omega$	$V_{DD} = 2.7\text{ V}$ , $I_W = 2.0\text{ mA}$ , code = 00h
Nominal Resistance Tempco	$\Delta R_{AB} / \Delta T$	—	50	—	ppm/ $^{\circ}\text{C}$	$T_A = -20^{\circ}\text{C}$ to $+70^{\circ}\text{C}$
		—	100	—	ppm/ $^{\circ}\text{C}$	$T_A = -40^{\circ}\text{C}$ to $+85^{\circ}\text{C}$
		—	150	—	ppm/ $^{\circ}\text{C}$	$T_A = -40^{\circ}\text{C}$ to $+125^{\circ}\text{C}$
Ratiometric Tempco	$\Delta V_{WB} / \Delta T$	—	15	—	ppm/ $^{\circ}\text{C}$	Code = Mid-scale (80h or 40h)
Resistor Terminal Input Voltage Range (Terminals A, B and W)	$V_A, V_W, V_B$	$V_{SS}$	—	$V_{DD}$	V	<b>Note 5, Note 6</b>

- Note 1:** Resistance is defined as the resistance between terminal A to terminal B.
- 2:** INL and DNL are measured at  $V_W$  with  $V_A = V_{DD}$  and  $V_B = V_{SS}$ .
- 3:** **MCP4XX1** only.
- 4:** **MCP4XX2** only, includes  $V_{WZSE}$  and  $V_{WFSE}$ .
- 5:** Resistor terminals A, W and B's polarity with respect to each other is not restricted.
- 6:** This specification by design.
- 7:** Non-linearity is affected by wiper resistance ( $R_W$ ), which changes significantly overvoltage and temperature.
- 8:** The **MCP4XX1** is externally connected to match the configurations of the **MCP45X2** and **MCP46X2**, and then tested.
- 9:** POR/BOR is not rate dependent.
- 10:** Supply current is independent of current through the resistor network.
- 11:** When  $HVC/A0 = V_{IHH}$ , the  $I_{DD}$  current is less due to current into the HVC/A0 pin. See  $I_{PU}$  specification.

# MCP454X/456X/464X/466X

## AC/DC CHARACTERISTICS (CONTINUED)

DC Characteristics		Standard Operating Conditions (unless otherwise specified) Operating Temperature $-40^{\circ}\text{C} \leq T_A \leq +125^{\circ}\text{C}$ (extended) All parameters apply across the specified operating ranges unless noted. $V_{DD} = +2.7\text{V}$ to $5.5\text{V}$ , $5\text{ k}\Omega$ , $10\text{ k}\Omega$ , $50\text{ k}\Omega$ , $100\text{ k}\Omega$ devices. Typical specifications represent values for $V_{DD} = 5.5\text{V}$ , $T_A = +25^{\circ}\text{C}$ .					
Parameters	Sym	Min	Typ	Max	Units	Conditions	
Maximum current through Terminal (A, W or B) <b>Note 6</b>	$I_T$	—	—	2.5	mA	Terminal A $I_{AW}$ , $W = \text{Full-Scale (FS)}$	
		—	—	2.5	mA	Terminal B $I_{BW}$ , $W = \text{Zero Scale (ZS)}$	
		—	—	2.5	mA	Terminal W $I_{AW}$ or $I_{BW}$ , $W = \text{FS or ZS}$	
		—	—	1.38	mA	Terminal A and Terminal B $I_{AB}$ , $V_B = 0\text{V}$ , $V_A = 5.5\text{V}$ , $R_{AB(\text{MIN})} = 4000$	
		—	—	0.688	mA		$I_{AB}$ , $V_B = 0\text{V}$ , $V_A = 5.5\text{V}$ , $R_{AB(\text{MIN})} = 8000$
		—	—	0.138	mA		$I_{AB}$ , $V_B = 0\text{V}$ , $V_A = 5.5\text{V}$ , $R_{AB(\text{MIN})} = 40000$
		—	—	0.069	mA		$I_{AB}$ , $V_B = 0\text{V}$ , $V_A = 5.5\text{V}$ , $R_{AB(\text{MIN})} = 80000$
Leakage current into A, W or B	$I_{WL}$	—	100	—	nA	<b>MCP4XX1</b> $PxA = PxW = PxB = V_{SS}$	
		—	100	—	nA	<b>MCP4XX2</b> $PxB = PxW = V_{SS}$	
		—	100	—	nA	Terminals Disconnected ( $R1HW = R0HW = 0$ )	

- Note 1:** Resistance is defined as the resistance between terminal A to terminal B.
- Note 2:** INL and DNL are measured at  $V_W$  with  $V_A = V_{DD}$  and  $V_B = V_{SS}$ .
- Note 3:** **MCP4XX1** only.
- Note 4:** **MCP4XX2** only, includes  $V_{WZSE}$  and  $V_{WFSE}$ .
- Note 5:** Resistor terminals A, W and B's polarity with respect to each other is not restricted.
- Note 6:** This specification by design.
- Note 7:** Non-linearity is affected by wiper resistance ( $R_W$ ), which changes significantly overvoltage and temperature.
- Note 8:** The **MCP4XX1** is externally connected to match the configurations of the **MCP45X2** and **MCP46X2**, and then tested.
- Note 9:** POR/BOR is not rate dependent.
- Note 10:** Supply current is independent of current through the resistor network.
- Note 11:** When  $HVC/A0 = V_{IHH}$ , the  $I_{DD}$  current is less due to current into the HVC/A0 pin. See  $I_{PU}$  specification.

# MCP454X/456X/464X/466X

## AC/DC CHARACTERISTICS (CONTINUED)

DC Characteristics		Standard Operating Conditions (unless otherwise specified) Operating Temperature $-40^{\circ}\text{C} \leq T_A \leq +125^{\circ}\text{C}$ (extended) All parameters apply across the specified operating ranges unless noted. $V_{DD} = +2.7\text{V}$ to $5.5\text{V}$ , $5\text{ k}\Omega$ , $10\text{ k}\Omega$ , $50\text{ k}\Omega$ , $100\text{ k}\Omega$ devices. Typical specifications represent values for $V_{DD} = 5.5\text{V}$ , $T_A = +25^{\circ}\text{C}$ .						
Parameters	Sym	Min	Typ	Max	Units	Conditions		
Full-Scale Error (MCP4XX1 only) (8-bit code = 100h, 7-bit code = 80h)	$V_{WFSE}$	-6.0	-0.1	—	LSb	5 k $\Omega$	8-bit	$3.0\text{V} \leq V_{DD} \leq 5.5\text{V}$
		-4.0	-0.1	—	LSb		7-bit	$3.0\text{V} \leq V_{DD} \leq 5.5\text{V}$
		-3.5	-0.1	—	LSb	10 k $\Omega$	8-bit	$3.0\text{V} \leq V_{DD} \leq 5.5\text{V}$
		-2.0	-0.1	—	LSb		7-bit	$3.0\text{V} \leq V_{DD} \leq 5.5\text{V}$
		-0.8	-0.1	—	LSb	50 k $\Omega$	8-bit	$3.0\text{V} \leq V_{DD} \leq 5.5\text{V}$
		-0.5	-0.1	—	LSb		7-bit	$3.0\text{V} \leq V_{DD} \leq 5.5\text{V}$
		-0.5	-0.1	—	LSb	100 k $\Omega$	8-bit	$3.0\text{V} \leq V_{DD} \leq 5.5\text{V}$
		-0.5	-0.1	—	LSb		7-bit	$3.0\text{V} \leq V_{DD} \leq 5.5\text{V}$
Zero-Scale Error (MCP4XX1 only) (8-bit code = 00h, 7-bit code = 00h)	$V_{WZSE}$	—	+0.1	+6.0	LSb	5 k $\Omega$	8-bit	$3.0\text{V} \leq V_{DD} \leq 5.5\text{V}$
		—	+0.1	+3.0	LSb		7-bit	$3.0\text{V} \leq V_{DD} \leq 5.5\text{V}$
		—	+0.1	+3.5	LSb	10 k $\Omega$	8-bit	$3.0\text{V} \leq V_{DD} \leq 5.5\text{V}$
		—	+0.1	+2.0	LSb		7-bit	$3.0\text{V} \leq V_{DD} \leq 5.5\text{V}$
		—	+0.1	+0.8	LSb	50 k $\Omega$	8-bit	$3.0\text{V} \leq V_{DD} \leq 5.5\text{V}$
		—	+0.1	+0.5	LSb		7-bit	$3.0\text{V} \leq V_{DD} \leq 5.5\text{V}$
		—	+0.1	+0.5	LSb	100 k $\Omega$	8-bit	$3.0\text{V} \leq V_{DD} \leq 5.5\text{V}$
		—	+0.1	+0.5	LSb		7-bit	$3.0\text{V} \leq V_{DD} \leq 5.5\text{V}$
Potentiometer Integral Non-linearity	INL	-1	$\pm 0.5$	+1	LSb	8-bit	$3.0\text{V} \leq V_{DD} \leq 5.5\text{V}$	
		-0.5	$\pm 0.25$	+0.5	LSb	7-bit	MCP4XX1 devices only (Note 2)	
Potentiometer Differential Non-linearity	DNL	-0.5	$\pm 0.25$	+0.5	LSb	8-bit	$3.0\text{V} \leq V_{DD} \leq 5.5\text{V}$	
		-0.25	$\pm 0.125$	+0.25	LSb	7-bit	MCP4XX1 devices only (Note 2)	

- Note 1:** Resistance is defined as the resistance between terminal A to terminal B.
- 2:** INL and DNL are measured at  $V_W$  with  $V_A = V_{DD}$  and  $V_B = V_{SS}$ .
- 3:** MCP4XX1 only.
- 4:** MCP4XX2 only, includes  $V_{WZSE}$  and  $V_{WFSE}$ .
- 5:** Resistor terminals A, W and B's polarity with respect to each other is not restricted.
- 6:** This specification by design.
- 7:** Non-linearity is affected by wiper resistance ( $R_W$ ), which changes significantly overvoltage and temperature.
- 8:** The MCP4XX1 is externally connected to match the configurations of the MCP45X2 and MCP46X2, and then tested.
- 9:** POR/BOR is not rate dependent.
- 10:** Supply current is independent of current through the resistor network.
- 11:** When  $HVC/A0 = V_{IH}$ , the  $I_{DD}$  current is less due to current into the HVC/A0 pin. See  $I_{PU}$  specification.

# MCP454X/456X/464X/466X

## AC/DC CHARACTERISTICS (CONTINUED)

DC Characteristics		Standard Operating Conditions (unless otherwise specified) Operating Temperature $-40^{\circ}\text{C} \leq T_A \leq +125^{\circ}\text{C}$ (extended) All parameters apply across the specified operating ranges unless noted. $V_{DD} = +2.7\text{V}$ to $5.5\text{V}$ , $5\text{ k}\Omega$ , $10\text{ k}\Omega$ , $50\text{ k}\Omega$ , $100\text{ k}\Omega$ devices. Typical specifications represent values for $V_{DD} = 5.5\text{V}$ , $T_A = +25^{\circ}\text{C}$ .						
Parameters	Sym	Min	Typ	Max	Units	Conditions		
Bandwidth -3 dB (See Figure 2-58, load = 30 pF)	BW	—	2	—	MHz	5 k $\Omega$	8-bit	Code = 80h
		—	2	—	MHz		7-bit	Code = 40h
		—	1	—	MHz	10 k $\Omega$	8-bit	Code = 80h
		—	1	—	MHz		7-bit	Code = 40h
		—	200	—	kHz	50 k $\Omega$	8-bit	Code = 80h
		—	200	—	kHz		7-bit	Code = 40h
		—	100	—	kHz	100 k $\Omega$	8-bit	Code = 80h
		—	100	—	kHz		7-bit	Code = 40h

- Note 1:** Resistance is defined as the resistance between terminal A to terminal B.
- 2:** INL and DNL are measured at  $V_W$  with  $V_A = V_{DD}$  and  $V_B = V_{SS}$ .
- 3:** **MCP4XX1** only.
- 4:** **MCP4XX2** only, includes  $V_{WZSE}$  and  $V_{WFSE}$ .
- 5:** Resistor terminals A, W and B's polarity with respect to each other is not restricted.
- 6:** This specification by design.
- 7:** Non-linearity is affected by wiper resistance ( $R_W$ ), which changes significantly overvoltage and temperature.
- 8:** The **MCP4XX1** is externally connected to match the configurations of the **MCP45X2** and **MCP46X2**, and then tested.
- 9:** POR/BOR is not rate dependent.
- 10:** Supply current is independent of current through the resistor network.
- 11:** When  $HVC/A0 = V_{IHH}$ , the  $I_{DD}$  current is less due to current into the HVC/A0 pin. See  $I_{PU}$  specification.



# MCP454X/456X/464X/466X

## AC/DC CHARACTERISTICS (CONTINUED)

DC Characteristics		Standard Operating Conditions (unless otherwise specified)						
		Operating Temperature $-40^{\circ}\text{C} \leq T_A \leq +125^{\circ}\text{C}$ (extended)						
		All parameters apply across the specified operating ranges unless noted.						
		$V_{DD} = +2.7\text{V}$ to $5.5\text{V}$ , $5\text{ k}\Omega$ , $10\text{ k}\Omega$ , $50\text{ k}\Omega$ , $100\text{ k}\Omega$ devices.						
		Typical specifications represent values for $V_{DD} = 5.5\text{V}$ , $T_A = +25^{\circ}\text{C}$ .						
Parameters	Sym	Min	Typ	Max	Units	Conditions		
Rheostat Integral Non-linearity <b>MCP45X1</b> (Note 4, Note 8) <b>MCP4XX2</b> devices only (Note 4)	R-INL	-1.5	$\pm 0.5$	+1.5	LSb	5 k $\Omega$	8-bit	5.5V, $I_W = 900\text{ }\mu\text{A}$
		-8.25	+4.5	+8.25	LSb			3.0V, $I_W = 480\text{ }\mu\text{A}$ (Note 7)
		-1.125	$\pm 0.5$	+1.125	LSb	5 k $\Omega$	7-bit	5.5V, $I_W = 900\text{ }\mu\text{A}$
		-6.0	+4.5	+6.0	LSb			3.0V, $I_W = 480\text{ }\mu\text{A}$ (Note 7)
		-1.5	$\pm 0.5$	+1.5	LSb	10 k $\Omega$	8-bit	5.5V, $I_W = 450\text{ }\mu\text{A}$
		-5.5	+2.5	+5.5	LSb			3.0V, $I_W = 240\text{ }\mu\text{A}$ (Note 7)
		-1.125	$\pm 0.5$	+1.125	LSb	10 k $\Omega$	7-bit	5.5V, $I_W = 450\text{ }\mu\text{A}$
		-4.0	+2.5	+4.0	LSb			3.0V, $I_W = 240\text{ }\mu\text{A}$ (Note 7)
		-1.5	$\pm 0.5$	+1.5	LSb	50 k $\Omega$	8-bit	5.5V, $I_W = 90\text{ }\mu\text{A}$
		-2.0	+1	+2.0	LSb			3.0V, $I_W = 48\text{ }\mu\text{A}$ (Note 7)
		-1.125	$\pm 0.5$	+1.125	LSb	50 k $\Omega$	7-bit	5.5V, $I_W = 90\text{ }\mu\text{A}$
		-1.5	+1	+1.5	LSb			3.0V, $I_W = 48\text{ }\mu\text{A}$ (Note 7)
		-1.0	$\pm 0.5$	+1.0	LSb	100 k $\Omega$	8-bit	5.5V, $I_W = 45\text{ }\mu\text{A}$
		-1.5	+0.25	+1.5	LSb			3.0V, $I_W = 24\text{ }\mu\text{A}$ (Note 7)
		-0.8	$\pm 0.5$	+0.8	LSb		7-bit	5.5V, $I_W = 45\text{ }\mu\text{A}$
		-1.125	+0.25	+1.125	LSb			3.0V, $I_W = 24\text{ }\mu\text{A}$ (Note 7)

- Note 1:** Resistance is defined as the resistance between terminal A to terminal B.
- Note 2:** INL and DNL are measured at  $V_W$  with  $V_A = V_{DD}$  and  $V_B = V_{SS}$ .
- Note 3:** **MCP4XX1** only.
- Note 4:** **MCP4XX2** only, includes  $V_{WZSE}$  and  $V_{WFSE}$ .
- Note 5:** Resistor terminals A, W and B's polarity with respect to each other is not restricted.
- Note 6:** This specification by design.
- Note 7:** Non-linearity is affected by wiper resistance ( $R_W$ ), which changes significantly overvoltage and temperature.
- Note 8:** The **MCP4XX1** is externally connected to match the configurations of the **MCP45X2** and **MCP46X2**, and then tested.
- Note 9:** POR/BOR is not rate dependent.
- Note 10:** Supply current is independent of current through the resistor network.
- Note 11:** When  $HVC/A0 = V_{IH}$ , the  $I_{DD}$  current is less due to current into the HVC/A0 pin. See  $I_{PU}$  specification.

# MCP454X/456X/464X/466X

## AC/DC CHARACTERISTICS (CONTINUED)

DC Characteristics		Standard Operating Conditions (unless otherwise specified) Operating Temperature $-40^{\circ}\text{C} \leq T_A \leq +125^{\circ}\text{C}$ (extended) All parameters apply across the specified operating ranges unless noted. $V_{DD} = +2.7\text{V}$ to $5.5\text{V}$ , $5\text{ k}\Omega$ , $10\text{ k}\Omega$ , $50\text{ k}\Omega$ , $100\text{ k}\Omega$ devices. Typical specifications represent values for $V_{DD} = 5.5\text{V}$ , $T_A = +25^{\circ}\text{C}$ .						
Parameters	Sym	Min	Typ	Max	Units	Conditions		
Rheostat Differential Non-linearity <b>MCP45X1</b> (Note 4, Note 8) <b>MCP4XX2</b> devices only (Note 4)	R-DNL	-0.5	$\pm 0.25$	+0.5	LSb	5 k $\Omega$	8-bit	5.5V, $I_W = 900\text{ }\mu\text{A}$
		-1.0	+0.5	+1.0	LSb			3.0V, $I_W = 480\text{ }\mu\text{A}$ (Note 7)
		-0.375	$\pm 0.25$	+0.375	LSb		7-bit	5.5V, $I_W = 900\text{ }\mu\text{A}$
		-0.75	+0.5	+0.75	LSb			3.0V, $I_W = 480\text{ }\mu\text{A}$ (Note 7)
		-0.5	$\pm 0.25$	+0.5	LSb	10 k $\Omega$	8-bit	5.5V, $I_W = 450\text{ }\mu\text{A}$
		-1.0	+0.25	+1.0	LSb			3.0V, $I_W = 240\text{ }\mu\text{A}$ (Note 7)
		-0.375	$\pm 0.25$	+0.375	LSb		7-bit	5.5V, $I_W = 450\text{ }\mu\text{A}$
		-0.75	+0.5	+0.75	LSb			3.0V, $I_W = 240\text{ }\mu\text{A}$ (Note 7)
		-0.5	$\pm 0.25$	+0.5	LSb	50 k $\Omega$	8-bit	5.5V, $I_W = 90\text{ }\mu\text{A}$
		-0.5	$\pm 0.25$	+0.5	LSb			3.0V, $I_W = 48\text{ }\mu\text{A}$ (Note 7)
		-0.375	$\pm 0.25$	+0.375	LSb		7-bit	5.5V, $I_W = 90\text{ }\mu\text{A}$
		-0.375	$\pm 0.25$	+0.375	LSb			3.0V, $I_W = 48\text{ }\mu\text{A}$ (Note 7)
		-0.5	$\pm 0.25$	+0.5	LSb	100 k $\Omega$	8-bit	5.5V, $I_W = 45\text{ }\mu\text{A}$
		-0.5	$\pm 0.25$	+0.5	LSb			3.0V, $I_W = 24\text{ }\mu\text{A}$ (Note 7)
		-0.375	$\pm 0.25$	+0.375	LSb		7-bit	5.5V, $I_W = 45\text{ }\mu\text{A}$
		-0.375	$\pm 0.25$	+0.375	LSb			3.0V, $I_W = 24\text{ }\mu\text{A}$ (Note 7)
Capacitance ( $P_A$ )	$C_{AW}$	—	75	—	pF	f = 1 MHz, Code = Full-Scale		
Capacitance ( $P_W$ )	$C_W$	—	120	—	pF	f = 1 MHz, Code = Full-Scale		
Capacitance ( $P_B$ )	$C_{BW}$	—	75	—	pF	f = 1 MHz, Code = Full-Scale		

- Note 1:** Resistance is defined as the resistance between terminal A to terminal B.
- 2:** INL and DNL are measured at  $V_W$  with  $V_A = V_{DD}$  and  $V_B = V_{SS}$ .
- 3:** **MCP4XX1** only.
- 4:** **MCP4XX2** only, includes  $V_{WZSE}$  and  $V_{WFSE}$ .
- 5:** Resistor terminals A, W and B's polarity with respect to each other is not restricted.
- 6:** This specification by design.
- 7:** Non-linearity is affected by wiper resistance ( $R_W$ ), which changes significantly overvoltage and temperature.
- 8:** The **MCP4XX1** is externally connected to match the configurations of the **MCP45X2** and **MCP46X2**, and then tested.
- 9:** POR/BOR is not rate dependent.
- 10:** Supply current is independent of current through the resistor network.
- 11:** When  $HVC/A0 = V_{IHH}$ , the  $I_{DD}$  current is less due to current into the HVC/A0 pin. See  $I_{PU}$  specification.

# MCP454X/456X/464X/466X

## AC/DC CHARACTERISTICS (CONTINUED)

DC Characteristics		Standard Operating Conditions (unless otherwise specified)						
		Operating Temperature $-40^{\circ}\text{C} \leq T_A \leq +125^{\circ}\text{C}$ (extended)						
		All parameters apply across the specified operating ranges unless noted.						
		$V_{DD} = +2.7\text{V}$ to $5.5\text{V}$ , $5\text{ k}\Omega$ , $10\text{ k}\Omega$ , $50\text{ k}\Omega$ , $100\text{ k}\Omega$ devices.						
		Typical specifications represent values for $V_{DD} = 5.5\text{V}$ , $T_A = +25^{\circ}\text{C}$ .						
Parameters	Sym	Min	Typ	Max	Units	Conditions		
<b>Digital Inputs/Outputs (SDA, SCK, HVC/A0, A1, A2, WP)</b>								
Schmitt Trigger High-Input Threshold	$V_{IH}$	$0.45 V_{DD}$	—	—	V	All Inputs except SDA and SCL	$2.7\text{V} \leq V_{DD} \leq 5.5\text{V}$ (Allows $2.7\text{V}$ Digital $V_{DD}$ with $5\text{V}$ Analog $V_{DD}$ )	
		$0.5 V_{DD}$	—	—	V		$1.8\text{V} \leq V_{DD} \leq 2.7\text{V}$	
		$0.7 V_{DD}$	—	$V_{MAX}$	V	SDA and SCL	100 kHz	
		$0.7 V_{DD}$	—	$V_{MAX}$	V		400 kHz	
		$0.7 V_{DD}$	—	$V_{MAX}$	V		1.7 MHz	
		$0.7 V_{DD}$	—	$V_{MAX}$	V		3.4 Mhz	
Schmitt Trigger Low-Input Threshold	$V_{IL}$	—	—	$0.2V_{DD}$	V	All inputs except SDA and SCL		
		-0.5	—	$0.3V_{DD}$	V	SDA and SCL	100 kHz	
		-0.5	—	$0.3V_{DD}$	V		400 kHz	
		-0.5	—	$0.3V_{DD}$	V		1.7 MHz	
		-0.5	—	$0.3V_{DD}$	V		3.4 Mhz	
Hysteresis of Schmitt Trigger Inputs (Note 6)	$V_{HYS}$	—	$0.1V_{DD}$	—	V	All inputs except SDA and SCL		
		N.A.	—	—	V	SDA and SCL	100 kHz	$V_{DD} < 2.0\text{V}$
		N.A.	—	—	V		$V_{DD} \geq 2.0\text{V}$	
		$0.1 V_{DD}$	—	—	V		400 kHz	$V_{DD} < 2.0\text{V}$
		$0.05 V_{DD}$	—	—	V		$V_{DD} \geq 2.0\text{V}$	
		$0.1 V_{DD}$	—	—	V		1.7 MHz	
		$0.1 V_{DD}$	—	—	V		3.4 Mhz	
High-Voltage Input Entry Voltage	$V_{IHHEN}$	8.5	—	$12.5^{(6)}$	V		Threshold for WiperLock™ Technology	
High-Voltage Input Exit Voltage	$V_{IHHEX}$	—	—	$V_{DD} + 0.8\text{V}^{(6)}$	V			
High-Voltage Limit	$V_{MAX}$	—	—	$12.5^{(6)}$	V	Pin can tolerate $V_{MAX}$ or less.		

- Note 1:** Resistance is defined as the resistance between terminal A to terminal B.
- 2:** INL and DNL are measured at  $V_W$  with  $V_A = V_{DD}$  and  $V_B = V_{SS}$ .
- 3:** MCP4XX1 only.
- 4:** MCP4XX2 only, includes  $V_{WZSE}$  and  $V_{WFSE}$ .
- 5:** Resistor terminals A, W and B's polarity with respect to each other is not restricted.
- 6:** This specification by design.
- 7:** Non-linearity is affected by wiper resistance ( $R_W$ ), which changes significantly overvoltage and temperature.
- 8:** The MCP4XX1 is externally connected to match the configurations of the MCP45X2 and MCP46X2, and then tested.
- 9:** POR/BOR is not rate dependent.
- 10:** Supply current is independent of current through the resistor network.
- 11:** When  $HVC/A0 = V_{IHH}$ , the  $I_{DD}$  current is less due to current into the HVC/A0 pin. See  $I_{PU}$  specification.

# MCP454X/456X/464X/466X

## AC/DC CHARACTERISTICS (CONTINUED)

DC Characteristics		Standard Operating Conditions (unless otherwise specified) Operating Temperature $-40^{\circ}\text{C} \leq T_A \leq +125^{\circ}\text{C}$ (extended) All parameters apply across the specified operating ranges unless noted. $V_{DD} = +2.7\text{V}$ to $5.5\text{V}$ , $5\text{ k}\Omega$ , $10\text{ k}\Omega$ , $50\text{ k}\Omega$ , $100\text{ k}\Omega$ devices. Typical specifications represent values for $V_{DD} = 5.5\text{V}$ , $T_A = +25^{\circ}\text{C}$ .					
Parameters	Sym	Min	Typ	Max	Units	Conditions	
Output Low Voltage (SDA)	$V_{OL}$	$V_{SS}$	—	$0.2V_{DD}$	V	$V_{DD} < 2.0\text{V}$ , $I_{OL} = 1\text{ mA}$	
		$V_{SS}$	—	0.4	V	$V_{DD} \geq 2.0\text{V}$ , $I_{OL} = 3\text{ mA}$	
Weak Pull-up / Pull-down Current	$I_{PU}$	—	—	1.75	mA	Internal $V_{DD}$ pull-up, $V_{IHH}$ pull-down $V_{DD} = 5.5\text{V}$ , $V_{IHH} = 12.5\text{V}$	
		—	170	—	$\mu\text{A}$	HVC pin, $V_{DD} = 5.5\text{V}$ , $V_{HVC} = 3\text{V}$	
HVC Pull-up / Pull-down Resistance	$R_{HVC}$	—	16	—	$\text{k}\Omega$	$V_{DD} = 5.5\text{V}$ , $V_{HVC} = 3\text{V}$	
Input Leakage Current	$I_{IL}$	-1	—	1	$\mu\text{A}$	$V_{IN} = V_{DD}$ and $V_{IN} = V_{SS}$	
Pin Capacitance	$C_{IN}$ , $C_{OUT}$	—	10	—	pF	$f_C = 3.4\text{ MHz}$	
<b>RAM (Wiper) Value</b>							
Value Range	N	0h	—	1FFh	hex	8-bit device	
		0h	—	1FFh	hex	7-bit device	
TCON POR/BOR Value	$N_{TCON}$	1FFh			hex	All Terminals connected	
<b>EEPROM</b>							
Endurance	$E_{endurance}$	—	1M	—	Cycles		
EEPROM Range	N	0h	—	1FFh	hex		
Initial Factory Setting	N	80h			hex	8-bit	WiperLock Technology = Off
		40h			hex	7-bit	WiperLock Technology = Off
EEPROM Programming Write Cycle Time	$t_{WC}$	—	5	10	ms		
<b>Power Requirements</b>							
Power Supply Sensitivity (MCP45X2 and MCP46X2 only)	PSS	—	0.0015	0.0035	%/%	8-bit	$V_{DD} = 2.7\text{V}$ to $5.5\text{V}$ , $V_A = 2.7\text{V}$ , Code = 80h
		—	0.0015	0.0035	%/%	7-bit	$V_{DD} = 2.7\text{V}$ to $5.5\text{V}$ , $V_A = 2.7\text{V}$ , Code = 40h

**Note 1:** Resistance is defined as the resistance between terminal A to terminal B.

**2:** INL and DNL are measured at  $V_W$  with  $V_A = V_{DD}$  and  $V_B = V_{SS}$ .

**3:** MCP4XX1 only.

**4:** MCP4XX2 only, includes  $V_{WZSE}$  and  $V_{WFSE}$ .

**5:** Resistor terminals A, W and B's polarity with respect to each other is not restricted.

**6:** This specification by design.

**7:** Non-linearity is affected by wiper resistance ( $R_W$ ), which changes significantly overvoltage and temperature.

**8:** The MCP4XX1 is externally connected to match the configurations of the MCP45X2 and MCP46X2, and then tested.

**9:** POR/BOR is not rate dependent.

**10:** Supply current is independent of current through the resistor network.

**11:** When  $HVC/A0 = V_{IHH}$ , the  $I_{DD}$  current is less due to current into the HVC/A0 pin. See  $I_{PU}$  specification.

# MCP454X/456X/464X/466X



**FIGURE 1-1:** I<sup>2</sup>C Bus Start/Stop Bits Timing Waveforms.

**TABLE 1-1: I<sup>2</sup>C BUS START/STOP BITS REQUIREMENTS**

I <sup>2</sup> C AC Characteristics		Standard Operating Conditions (unless otherwise specified)					
		Operating Temperature $-40^{\circ}\text{C} \leq T_A \leq +125^{\circ}\text{C}$ (Extended)					
		Operating Voltage VDD range is described in <a href="#">AC/DC characteristics</a>					
Param. No.	Symbol	Characteristic	Min	Max	Units	Conditions	
	$F_{\text{SCL}}$	Standard mode	0	100	kHz	$C_b = 400 \text{ pF}$ , 1.8V - 5.5V	
		Fast mode	0	400	kHz		$C_b = 400 \text{ pF}$ , 2.7V - 5.5V
		High-Speed 1.7	0	1.7	MHz		$C_b = 400 \text{ pF}$ , 4.5V - 5.5V
		High-Speed 3.4	0	3.4	MHz		$C_b = 100 \text{ pF}$ , 4.5V - 5.5V
D102	$C_b$	Bus capacitive loading	100 kHz mode	—	400	pF	
			400 kHz mode	—	400	pF	
			1.7 MHz mode	—	400	pF	
			3.4 MHz mode	—	100	pF	
90	T <sub>SU:STA</sub>	START condition Setup time	100 kHz mode	4700	—	ns	Only relevant for repeated START condition
			400 kHz mode	600	—	ns	
			1.7 MHz mode	160	—	ns	
			3.4 MHz mode	160	—	ns	
91	T <sub>HD:STA</sub>	START condition Hold time	100 kHz mode	4000	—	ns	After this period the first clock pulse is generated
			400 kHz mode	600	—	ns	
			1.7 MHz mode	160	—	ns	
			3.4 MHz mode	160	—	ns	
92	T <sub>SU:STO</sub>	STOP condition Setup time	100 kHz mode	4000	—	ns	
			400 kHz mode	600	—	ns	
			1.7 MHz mode	160	—	ns	
			3.4 MHz mode	160	—	ns	
93	T <sub>HD:STO</sub>	STOP condition Hold time	100 kHz mode	4000	—	ns	
			400 kHz mode	600	—	ns	
			1.7 MHz mode	160	—	ns	
			3.4 MHz mode	160	—	ns	

# MCP454X/456X/464X/466X



**FIGURE 1-2:** I<sup>2</sup>C Bus Data Timing.

**TABLE 1-2: I<sup>2</sup>C BUS DATA REQUIREMENTS (SLAVE MODE)**

I <sup>2</sup> C AC Characteristics			Standard Operating Conditions (unless otherwise specified)				
			Operating Temperature -40°C ≤ T <sub>A</sub> ≤ +125°C (Extended)				
			Operating Voltage V <sub>DD</sub> range is described in <a href="#">AC/DC characteristics</a>				
Param. No.	Sym	Characteristic	Min	Max	Units	Conditions	
100	T <sub>HIGH</sub>	Clock high time	100 kHz mode	4000	—	ns	1.8V-5.5V
			400 kHz mode	600	—	ns	2.7V-5.5V
			1.7 MHz mode	120	—	ns	4.5V-5.5V
			3.4 MHz mode	60	—	ns	4.5V-5.5V
101	T <sub>LOW</sub>	Clock low time	100 kHz mode	4700	—	ns	1.8V-5.5V
			400 kHz mode	1300	—	ns	2.7V-5.5V
			1.7 MHz mode	320	—	ns	4.5V-5.5V
			3.4 MHz mode	160	—	ns	4.5V-5.5V

- Note 1:** As a transmitter, the device must provide this internal minimum delay time to bridge the undefined region (minimum 300 ns) of the falling edge of SCL to avoid unintended generation of START or STOP conditions.
- 2:** A fast-mode (400 kHz) I<sup>2</sup>C-bus device can be used in a standard-mode (100 kHz) I<sup>2</sup>C-bus system, but the requirement t<sub>SU;DAT</sub> ≥ 250 ns must then be met. This will automatically be the case if the device does not stretch the LOW period of the SCL signal. If such a device does stretch the LOW period of the SCL signal, it must output the next data bit to the SDA line.  
T<sub>R max.</sub>+t<sub>SU;DAT</sub> = 1000 + 250 = 1250 ns (according to the standard-mode I<sup>2</sup>C bus specification) before the SCL line is released.
- 3:** The MCP46X1/MCP46X2 device must provide a data hold time to bridge the undefined part between V<sub>IH</sub> and V<sub>IL</sub> of the falling edge of the SCL signal. This specification is not a part of the I<sup>2</sup>C specification, but must be tested in order to ensure that the output data will meet the setup and hold specifications for the receiving device.
- 4:** Use C<sub>b</sub> in pF for the calculations.
- 5:** Not tested.
- 6:** A Master Transmitter must provide a delay to ensure that difference between SDA and SCL fall times do not unintentionally create a Start or Stop condition.
- 7:** Ensured by the T<sub>AA</sub> 3.4 MHz specification test.

# MCP454X/456X/464X/466X

**TABLE 1-2: I<sup>2</sup>C BUS DATA REQUIREMENTS (SLAVE MODE) (CONTINUED)**

I <sup>2</sup> C AC Characteristics		Standard Operating Conditions (unless otherwise specified) Operating Temperature $-40^{\circ}\text{C} \leq T_A \leq +125^{\circ}\text{C}$ (Extended) Operating Voltage $V_{DD}$ range is described in <a href="#">AC/DC characteristics</a>							
Param. No.	Sym	Characteristic	Min	Max	Units	Conditions			
102A <sup>(5)</sup>	T <sub>RSCL</sub>	SCL rise time	100 kHz mode	—	1000	ns	Cb is specified to be from 10 to 400 pF (100 pF maximum for 3.4 MHz mode)		
			400 kHz mode	20 + 0.1Cb	300	ns			
			1.7 MHz mode	20	80	ns			
					1.7 MHz mode	20	160	ns	After a Repeated Start condition or an Acknowledge bit
					3.4 MHz mode	10	40	ns	
					3.4 MHz mode	10	80	ns	After a Repeated Start condition or an Acknowledge bit
102B <sup>(5)</sup>	T <sub>RSDA</sub>	SDA rise time	100 kHz mode	—	1000	ns	Cb is specified to be from 10 to 400 pF (100 pF max for 3.4 MHz mode)		
			400 kHz mode	20 + 0.1Cb	300	ns			
			1.7 MHz mode	20	160	ns			
			3.4 MHz mode	10	80	ns			
103A <sup>(5)</sup>	T <sub>FSCL</sub>	SCL fall time	100 kHz mode	—	300	ns	Cb is specified to be from 10 to 400 pF (100 pF max for 3.4 MHz mode)		
			400 kHz mode	20 + 0.1Cb	300	ns			
			1.7 MHz mode	20	80	ns			
			3.4 MHz mode	10	40	ns			
103B <sup>(5)</sup>	T <sub>FSDA</sub>	SDA fall time	100 kHz mode	—	300	ns	Cb is specified to be from 10 to 400 pF (100 pF max for 3.4 MHz mode)		
			400 kHz mode	20 + 0.1Cb <sup>(4)</sup>	300	ns			
			1.7 MHz mode	20	160	ns			
			3.4 MHz mode	10	80	ns			
106	T <sub>HD:DAT</sub>	Data input hold time	100 kHz mode	0	—	ns	1.8V-5.5V, <a href="#">Note 6</a>		
			400 kHz mode	0	—	ns	2.7V-5.5V, <a href="#">Note 6</a>		
			1.7 MHz mode	0	—	ns	4.5V-5.5V, <a href="#">Note 6</a>		
			3.4 MHz mode	0	—	ns	4.5V-5.5V, <a href="#">Note 6</a>		

- Note 1:** As a transmitter, the device must provide this internal minimum delay time to bridge the undefined region (minimum 300 ns) of the falling edge of SCL to avoid unintended generation of START or STOP conditions.
- 2:** A fast-mode (400 kHz) I<sup>2</sup>C-bus device can be used in a standard-mode (100 kHz) I<sup>2</sup>C-bus system, but the requirement  $t_{SU:DAT} \geq 250$  ns must then be met. This will automatically be the case if the device does not stretch the LOW period of the SCL signal. If such a device does stretch the LOW period of the SCL signal, it must output the next data bit to the SDA line.  
 $T_R \text{ max.} + t_{SU:DAT} = 1000 + 250 = 1250$  ns (according to the standard-mode I<sup>2</sup>C bus specification) before the SCL line is released.
- 3:** The MCP46X1/MCP46X2 device must provide a data hold time to bridge the undefined part between  $V_{IH}$  and  $V_{IL}$  of the falling edge of the SCL signal. This specification is not a part of the I<sup>2</sup>C specification, but must be tested in order to ensure that the output data will meet the setup and hold specifications for the receiving device.
- 4:** Use Cb in pF for the calculations.
- 5:** Not tested.
- 6:** A Master Transmitter must provide a delay to ensure that difference between SDA and SCL fall times do not unintentionally create a Start or Stop condition.
- 7:** Ensured by the T<sub>AA</sub> 3.4 MHz specification test.

# MCP454X/456X/464X/466X

**TABLE 1-2: I<sup>2</sup>C BUS DATA REQUIREMENTS (SLAVE MODE) (CONTINUED)**

I <sup>2</sup> C AC Characteristics		Standard Operating Conditions (unless otherwise specified) Operating Temperature $-40^{\circ}\text{C} \leq T_A \leq +125^{\circ}\text{C}$ (Extended) Operating Voltage $V_{DD}$ range is described in <a href="#">AC/DC characteristics</a>					
Param. No.	Sym	Characteristic	Min	Max	Units	Conditions	
107	T <sub>SU;DAT</sub>	Data input setup time	100 kHz mode	250	—	ns	<a href="#">Note 2</a>
			400 kHz mode	100	—	ns	
			1.7 MHz mode	10	—	ns	
			3.4 MHz mode	10	—	ns	
109	T <sub>AA</sub>	Output valid from clock	100 kHz mode	—	3450	ns	<a href="#">Note 1</a>
			400 kHz mode	—	900	ns	
			1.7 MHz mode	—	150	ns	Cb = 100 pF, <a href="#">Note 1</a> , <a href="#">Note 7</a>
				—	310	ns	Cb = 400 pF, <a href="#">Note 1</a> , <a href="#">Note 5</a>
			3.4 MHz mode	—	150	ns	Cb = 100 pF, <a href="#">Note 1</a>
110	T <sub>BUF</sub>	Bus free time	100 kHz mode	4700	—	ns	Time the bus must be free before a new transmission can start
			400 kHz mode	1300	—	ns	
			1.7 MHz mode	N.A.	—	ns	
			3.4 MHz mode	N.A.	—	ns	
	T <sub>SP</sub>	Input filter spike suppression (SDA and SCL)	100 kHz mode	—	50	ns	Philips Spec states N.A.
			400 kHz mode	—	50	ns	
			1.7 MHz mode	—	10	ns	Spike suppression
			3.4 MHz mode	—	10	ns	Spike suppression

- Note 1:** As a transmitter, the device must provide this internal minimum delay time to bridge the undefined region (minimum 300 ns) of the falling edge of SCL to avoid unintended generation of START or STOP conditions.
- 2:** A fast-mode (400 kHz) I<sup>2</sup>C-bus device can be used in a standard-mode (100 kHz) I<sup>2</sup>C-bus system, but the requirement  $t_{\text{SU;DAT}} \geq 250$  ns must then be met. This will automatically be the case if the device does not stretch the LOW period of the SCL signal. If such a device does stretch the LOW period of the SCL signal, it must output the next data bit to the SDA line.  
 $T_R \text{ max.} + t_{\text{SU;DAT}} = 1000 + 250 = 1250$  ns (according to the standard-mode I<sup>2</sup>C bus specification) before the SCL line is released.
- 3:** The MCP46X1/MCP46X2 device must provide a data hold time to bridge the undefined part between  $V_{\text{IH}}$  and  $V_{\text{IL}}$  of the falling edge of the SCL signal. This specification is not a part of the I<sup>2</sup>C specification, but must be tested in order to ensure that the output data will meet the setup and hold specifications for the receiving device.
- 4:** Use Cb in pF for the calculations.
- 5:** Not tested.
- 6:** A Master Transmitter must provide a delay to ensure that difference between SDA and SCL fall times do not unintentionally create a Start or Stop condition.
- 7:** Ensured by the T<sub>AA</sub> 3.4 MHz specification test.



# MCP454X/456X/464X/466X

## TEMPERATURE CHARACTERISTICS

**Electrical Specifications:** Unless otherwise indicated,  $V_{DD} = +2.7V$  to  $+5.5V$ ,  $V_{SS} = GND$ .

Parameters	Sym	Min	Typ	Max	Units	Conditions
<b>Temperature Ranges</b>						
Specified Temperature Range	$T_A$	-40	—	+125	°C	
Operating Temperature Range	$T_A$	-40	—	+125	°C	
Storage Temperature Range	$T_A$	-65	—	+150	°C	
<b>Thermal Package Resistances</b>						
Thermal Resistance, 8L-DFN (3x3)	$\theta_{JA}$	—	56.7	—	°C/W	
Thermal Resistance, 8L-MSOP	$\theta_{JA}$	—	211	—	°C/W	
Thermal Resistance, 8L-SOIC	$\theta_{JA}$	—	149.5	—	°C/W	
Thermal Resistance, 10L-DFN (3x3)	$\theta_{JA}$	—	57	—	°C/W	
Thermal Resistance, 10L-MSOP	$\theta_{JA}$	—	202	—	°C/W	
Thermal Resistance, 14L-MSOP	$\theta_{JA}$	—	N/A	—	°C/W	
Thermal Resistance, 14L-SOIC	$\theta_{JA}$	—	95.3	—	°C/W	
Thermal Resistance, 16L-QFN	$\theta_{JA}$	—	47	—	°C/W	

# MCP454X/456X/464X/466X

---

NOTES:

## 2.0 TYPICAL PERFORMANCE CURVES

**Note:** The graphs and tables provided following this note are a statistical summary based on a limited number of samples and are provided for informational purposes only. The performance characteristics listed herein are not tested or guaranteed. In some graphs or tables, the data presented may be outside the specified operating range (e.g., outside specified power supply range) and therefore outside the warranted range.

**Note:** Unless otherwise indicated,  $T_A = +25^\circ\text{C}$ ,  $V_{DD} = 5\text{V}$ ,  $V_{SS} = 0\text{V}$ .



**FIGURE 2-1:** Device Current ( $I_{DD}$ ) vs.  $f_{SCL}$  Frequency ( $f_{SCL}$ ) and Ambient Temperature ( $V_{DD} = 2.7\text{V}$  and  $5.5\text{V}$ ).



**FIGURE 2-4:** HVC Pull-up/Pull-down Resistance ( $R_{HVC}$ ) and Current ( $I_{HVC}$ ) vs. HVC Input Voltage ( $V_{HVC}$ ) ( $V_{DD} = 5.5\text{V}$ ).



**FIGURE 2-2:** Device Current ( $I_{SHDN}$ ) and  $V_{DD}$ . ( $HVC = V_{DD}$ ) vs. Ambient Temperature.



**FIGURE 2-5:** HVC High Input Entry/Exit Threshold vs. Ambient Temperature and  $V_{DD}$ .



**FIGURE 2-3:** Write Current ( $I_{WRITE}$ ) vs. Ambient Temperature.

# MCP454X/456X/464X/466X

Note: Unless otherwise indicated,  $T_A = +25^\circ\text{C}$ ,  $V_{DD} = 5\text{V}$ ,  $V_{SS} = 0\text{V}$ .



**FIGURE 2-6:** 5 k $\Omega$  Pot Mode –  $R_W$  ( $\Omega$ ), INL (LSb), DNL (LSb) vs. Wiper Setting and Ambient Temperature ( $V_{DD} = 5.5\text{V}$ ).



**FIGURE 2-8:** 5 k $\Omega$  Rheo Mode –  $R_W$  ( $\Omega$ ), INL (LSb), DNL (LSb) vs. Wiper Setting and Ambient Temperature ( $V_{DD} = 5.5\text{V}$ ).



**FIGURE 2-7:** 5 k $\Omega$  Pot Mode –  $R_W$  ( $\Omega$ ), INL (LSb), DNL (LSb) vs. Wiper Setting and Ambient Temperature ( $V_{DD} = 3.0\text{V}$ ).



**FIGURE 2-9:** 5 k $\Omega$  Rheo Mode –  $R_W$  ( $\Omega$ ), INL (LSb), DNL (LSb) vs. Wiper Setting and Ambient Temperature ( $V_{DD} = 3.0\text{V}$ ).

# MCP454X/456X/464X/466X

**Note:** Unless otherwise indicated,  $T_A = +25^\circ\text{C}$ ,  $V_{DD} = 5\text{V}$ ,  $V_{SS} = 0\text{V}$ .



**FIGURE 2-10:**  $5\text{ k}\Omega$  – Nominal Resistance ( $\Omega$ ) vs. Ambient Temperature and  $V_{DD}$ .



**FIGURE 2-11:**  $5\text{ k}\Omega$  –  $R_{WB}$  ( $\Omega$ ) vs. Wiper Setting and Ambient Temperature.

# MCP454X/456X/464X/466X

Note: Unless otherwise indicated,  $T_A = +25^\circ\text{C}$ ,  $V_{DD} = 5\text{V}$ ,  $V_{SS} = 0\text{V}$ .



**FIGURE 2-12:** 5 k $\Omega$  – Low-Voltage Decrement Wiper Settling Time ( $V_{DD} = 5.5\text{V}$ ) (1  $\mu\text{s}/\text{Div}$ ).



**FIGURE 2-15:** 5 k $\Omega$  – Low-Voltage Increment Wiper Settling Time ( $V_{DD} = 5.5\text{V}$ ) (1  $\mu\text{s}/\text{Div}$ ).



**FIGURE 2-13:** 5 k $\Omega$  – Low-Voltage Decrement Wiper Settling Time ( $V_{DD} = 2.7\text{V}$ ) (1  $\mu\text{s}/\text{Div}$ ).



**FIGURE 2-16:** 5 k $\Omega$  – Low-Voltage Increment Wiper Settling Time ( $V_{DD} = 2.7\text{V}$ ) (1  $\mu\text{s}/\text{Div}$ ).



**FIGURE 2-14:** 5 k $\Omega$  – Power-Up Wiper Response Time (20 ms/Div).

# MCP454X/456X/464X/466X

**Note:** Unless otherwise indicated,  $T_A = +25^\circ\text{C}$ ,  $V_{DD} = 5\text{V}$ ,  $V_{SS} = 0\text{V}$ .



**FIGURE 2-17:** 10 k $\Omega$  Pot Mode –  $R_W$  ( $\Omega$ ), INL (LSb), DNL (LSb) vs. Wiper Setting and Ambient Temperature ( $V_{DD} = 5.5\text{V}$ ).



**FIGURE 2-19:** 10 k $\Omega$  Rheo Mode –  $R_W$  ( $\Omega$ ), INL (LSb), DNL (LSb) vs. Wiper Setting and Ambient Temperature ( $V_{DD} = 5.5\text{V}$ ).



**FIGURE 2-18:** 10 k $\Omega$  Pot Mode –  $R_W$  ( $\Omega$ ), INL (LSb), DNL (LSb) vs. Wiper Setting and Ambient Temperature ( $V_{DD} = 3.0\text{V}$ ).



**FIGURE 2-20:** 10 k $\Omega$  Rheo Mode –  $R_W$  ( $\Omega$ ), INL (LSb), DNL (LSb) vs. Wiper Setting and Ambient Temperature ( $V_{DD} = 3.0\text{V}$ ).

# MCP454X/456X/464X/466X

Note: Unless otherwise indicated,  $T_A = +25^\circ\text{C}$ ,  $V_{DD} = 5\text{V}$ ,  $V_{SS} = 0\text{V}$ .



FIGURE 2-21:  $10\text{ k}\Omega$  – Nominal Resistance ( $\Omega$ ) vs. Ambient Temperature and  $V_{DD}$ .



FIGURE 2-22:  $10\text{ k}\Omega$  –  $R_{WB}$  ( $\Omega$ ) vs. Wiper Setting and Ambient Temperature.



# MCP454X/456X/464X/466X

**Note:** Unless otherwise indicated,  $T_A = +25^\circ\text{C}$ ,  $V_{DD} = 5\text{V}$ ,  $V_{SS} = 0\text{V}$ .



**FIGURE 2-23:**  $10\text{ k}\Omega$  – Low-Voltage Decrement Wiper Settling Time ( $V_{DD} = 5.5\text{V}$ ) ( $1\text{ }\mu\text{s}/\text{Div}$ ).



**FIGURE 2-26:**  $10\text{ k}\Omega$  – Low-Voltage Increment Wiper Settling Time ( $V_{DD} = 5.5\text{V}$ ) ( $1\text{ }\mu\text{s}/\text{Div}$ ).



**FIGURE 2-24:**  $10\text{ k}\Omega$  – Low-Voltage Decrement Wiper Settling Time ( $V_{DD} = 2.7\text{V}$ ) ( $1\text{ }\mu\text{s}/\text{Div}$ ).



**FIGURE 2-27:**  $10\text{ k}\Omega$  – Low-Voltage Increment Wiper Settling Time ( $V_{DD} = 2.7\text{V}$ ) ( $1\text{ }\mu\text{s}/\text{Div}$ ).



**FIGURE 2-25:**  $10\text{ k}\Omega$  – Power-Up Wiper Response Time ( $1\text{ }\mu\text{s}/\text{Div}$ ).

# MCP454X/456X/464X/466X

Note: Unless otherwise indicated,  $T_A = +25^\circ\text{C}$ ,  $V_{DD} = 5\text{V}$ ,  $V_{SS} = 0\text{V}$ .



**FIGURE 2-28:** 50 kΩ Pot Mode –  $R_w$  ( $\Omega$ ), INL (LSb), DNL (LSb) vs. Wiper Setting and Ambient Temperature ( $V_{DD} = 5.5\text{V}$ ).



**FIGURE 2-30:** 50 kΩ Rheo Mode –  $R_w$  ( $\Omega$ ), INL (LSb), DNL (LSb) vs. Wiper Setting and Ambient Temperature ( $V_{DD} = 5.5\text{V}$ ).



**FIGURE 2-29:** 50 kΩ Pot Mode –  $R_w$  ( $\Omega$ ), INL (LSb), DNL (LSb) vs. Wiper Setting and Ambient Temperature ( $V_{DD} = 3.0\text{V}$ ).



**FIGURE 2-31:** 50 kΩ Rheo Mode –  $R_w$  ( $\Omega$ ), INL (LSb), DNL (LSb) vs. Wiper Setting and Ambient Temperature ( $V_{DD} = 3.0\text{V}$ ).

# MCP454X/456X/464X/466X

**Note:** Unless otherwise indicated,  $T_A = +25^\circ\text{C}$ ,  $V_{DD} = 5\text{V}$ ,  $V_{SS} = 0\text{V}$ .



**FIGURE 2-32:**  $50\text{ k}\Omega$  – Nominal Resistance ( $\Omega$ ) vs. Ambient Temperature and  $V_{DD}$ .



**FIGURE 2-33:**  $50\text{ k}\Omega$  –  $R_{WB}$  ( $\Omega$ ) vs. Wiper Setting and Ambient Temperature.

# MCP454X/456X/464X/466X

Note: Unless otherwise indicated,  $T_A = +25^\circ\text{C}$ ,  $V_{DD} = 5\text{V}$ ,  $V_{SS} = 0\text{V}$ .



**FIGURE 2-34:** 50 k $\Omega$  – Low-Voltage Decrement Wiper Settling Time ( $V_{DD} = 5.5\text{V}$ ) (1  $\mu\text{s}/\text{Div}$ ).



**FIGURE 2-37:** 50 k $\Omega$  – Low-Voltage Increment Wiper Settling Time ( $V_{DD} = 5.5\text{V}$ ) (1  $\mu\text{s}/\text{Div}$ ).



**FIGURE 2-35:** 50 k $\Omega$  – Low-Voltage Decrement Wiper Settling Time ( $V_{DD} = 2.7\text{V}$ ) (1  $\mu\text{s}/\text{Div}$ ).



**FIGURE 2-38:** 50 k $\Omega$  – Low-Voltage Increment Wiper Settling Time ( $V_{DD} = 2.7\text{V}$ ) (1  $\mu\text{s}/\text{Div}$ ).



**FIGURE 2-36:** 50 k $\Omega$  – Power-Up Wiper Response Time (1  $\mu\text{s}/\text{Div}$ ).

# MCP454X/456X/464X/466X

**Note:** Unless otherwise indicated,  $T_A = +25^\circ\text{C}$ ,  $V_{DD} = 5\text{V}$ ,  $V_{SS} = 0\text{V}$ .



**FIGURE 2-39:** 100 k $\Omega$  Pot Mode –  $R_W$  ( $\Omega$ ), INL (LSb), DNL (LSb) vs. Wiper Setting and Ambient Temperature ( $V_{DD} = 5.5\text{V}$ ).



**FIGURE 2-41:** 100 k $\Omega$  Rheo Mode –  $R_W$  ( $\Omega$ ), INL (LSb), DNL (LSb) vs. Wiper Setting and Ambient Temperature ( $V_{DD} = 5.5\text{V}$ ).



**FIGURE 2-40:** 100 k $\Omega$  Pot Mode –  $R_W$  ( $\Omega$ ), INL (LSb), DNL (LSb) vs. Wiper Setting and Ambient Temperature ( $V_{DD} = 3.0\text{V}$ ).



**FIGURE 2-42:** 100 k $\Omega$  Rheo Mode –  $R_W$  ( $\Omega$ ), INL (LSb), DNL (LSb) vs. Wiper Setting and Ambient Temperature ( $V_{DD} = 3.0\text{V}$ ).

# MCP454X/456X/464X/466X

Note: Unless otherwise indicated,  $T_A = +25^\circ\text{C}$ ,  $V_{DD} = 5\text{V}$ ,  $V_{SS} = 0\text{V}$ .



**FIGURE 2-43:**  $100\text{ k}\Omega$  – Nominal Resistance ( $\Omega$ ) vs. Ambient Temperature and  $V_{DD}$ .



**FIGURE 2-44:**  $100\text{ k}\Omega$  –  $R_{WB}$  ( $\Omega$ ) vs. Wiper Setting and Ambient Temperature.

# MCP454X/456X/464X/466X

**Note:** Unless otherwise indicated,  $T_A = +25^\circ\text{C}$ ,  $V_{DD} = 5\text{V}$ ,  $V_{SS} = 0\text{V}$ .



**FIGURE 2-45:** 100 k $\Omega$  – Low-Voltage Decrement Wiper Settling Time ( $V_{DD} = 5.5\text{V}$ ) ( $1\ \mu\text{s}/\text{Div}$ ).



**FIGURE 2-47:** 100 k $\Omega$  – Low-Voltage Increment Wiper Settling Time ( $V_{DD} = 5.5\text{V}$ ) ( $1\ \mu\text{s}/\text{Div}$ ).



**FIGURE 2-46:** 100 k $\Omega$  – Low-Voltage Decrement Wiper Settling Time ( $V_{DD} = 2.7\text{V}$ ) ( $1\ \mu\text{s}/\text{Div}$ ).



**FIGURE 2-48:** 100 k $\Omega$  – Low-Voltage Increment Wiper Settling Time ( $V_{DD} = 2.7\text{V}$ ) ( $1\ \mu\text{s}/\text{Div}$ ).

# MCP454X/456X/464X/466X

Note: Unless otherwise indicated,  $T_A = +25^\circ\text{C}$ ,  $V_{DD} = 5\text{V}$ ,  $V_{SS} = 0\text{V}$ .



**FIGURE 2-49:** Resistor Network 0 to Resistor Network 1  $R_{AB}$  ( $5\text{ k}\Omega$ ) Mismatch vs.  $V_{DD}$  and Temperature.



**FIGURE 2-51:** Resistor Network 0 to Resistor Network 1  $R_{AB}$  ( $50\text{ k}\Omega$ ) Mismatch vs.  $V_{DD}$  and Temperature.



**FIGURE 2-50:** Resistor Network 0 to Resistor Network 1  $R_{AB}$  ( $10\text{ k}\Omega$ ) Mismatch vs.  $V_{DD}$  and Temperature.

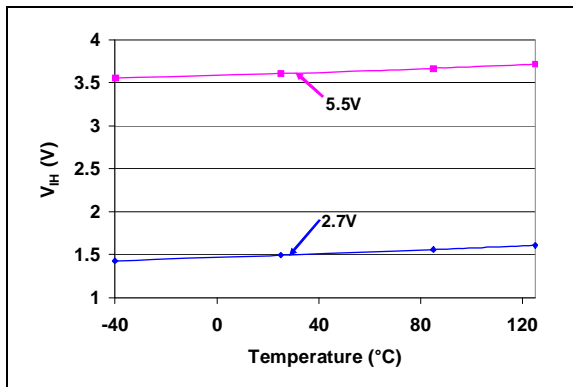

**FIGURE 2-52:** Resistor Network 0 to Resistor Network 1  $R_{AB}$  ( $100\text{ k}\Omega$ ) Mismatch vs.  $V_{DD}$  and Temperature.



# MCP454X/456X/464X/466X

**Note:** Unless otherwise indicated,  $T_A = +25^\circ\text{C}$ ,  $V_{DD} = 5\text{V}$ ,  $V_{SS} = 0\text{V}$ .



**FIGURE 2-53:**  $V_{IH}$  (SDA, SCL) vs.  $V_{DD}$  and Temperature.

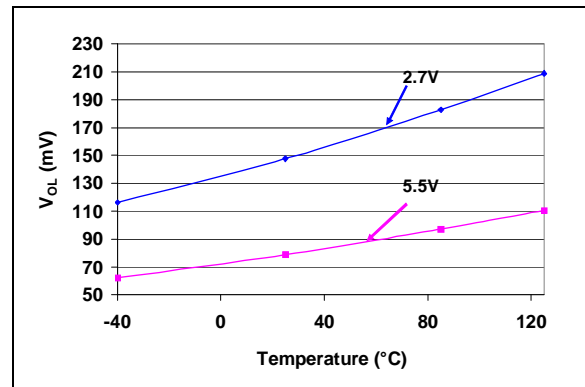

**FIGURE 2-55:**  $V_{OL}$  (SDA) vs.  $V_{DD}$  and Temperature ( $I_{OL} = 3\text{ mA}$ ).

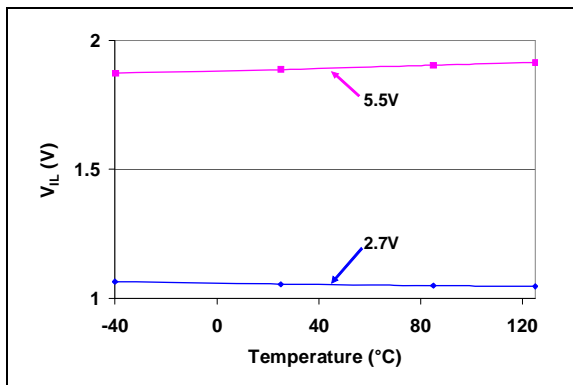

**FIGURE 2-54:**  $V_{IL}$  (SDA, SCL) vs.  $V_{DD}$  and Temperature.

# MCP454X/456X/464X/466X

**Note:** Unless otherwise indicated,  $T_A = +25^\circ\text{C}$ ,  $V_{DD} = 5\text{V}$ ,  $V_{SS} = 0\text{V}$ .



**FIGURE 2-56:** Nominal EEPROM Write Cycle Time vs.  $V_{DD}$  and Temperature.



**FIGURE 2-57:** POR/BOR Trip Point vs.  $V_{DD}$  and Temperature.

## 2.1 Test Circuits



**FIGURE 2-58:** -3 db Gain vs. Frequency Test.



**FIGURE 2-59:**  $R_{BW}$  and  $R_W$  Measurement.

# MCP454X/456X/464X/466X

## 3.0 PIN DESCRIPTIONS

The descriptions of the pins are listed in [Table 3-1](#). Additional descriptions of the device pins follow.

**TABLE 3-1: PINOUT DESCRIPTION FOR THE MCP454X/456X/464X/466X**

Pin					Symbol	I/O	Buffer Type	Weak Pull-up/down <sup>(1)</sup>	Standard Function
Single		Dual							
Rheo	Pot <sup>(1)</sup>	Rheo	Pot						
8L	8L	10L	14L	16L					
1	1	1	1	16	HVC/A0	I	HV w/ST	“smart”	High Voltage Command / Address 0.
2	2	2	2	1	SCL	I	HV w/ST	No	I <sup>2</sup> C clock input.
3	3	3	3	2	SDA	I/O	HV w/ST	No	I <sup>2</sup> C serial data I/O. Open Drain output
4	4	4	4	3, 4	V <sub>SS</sub>	—	P	—	Ground
—	—	5	5	5	P1B	A	Analog	No	Potentiometer 1 Terminal B
—	—	6	6	6	P1W	A	Analog	No	Potentiometer 1 Wiper Terminal
—	—	—	7	7	P1A	A	Analog	No	Potentiometer 1 Terminal A
—	5	—	8	8	P0A	A	Analog	No	Potentiometer 0 Terminal A
5	6	7	9	9	P0W	A	Analog	No	Potentiometer 0 Wiper Terminal
6	7	8	10	10	P0B	A	Analog	No	Potentiometer 0 Terminal B
—	—	—	11	12	WP	I	HV w/ST	“smart”	Hardware EEPROM Write Protect
—	—	—	12	13	A2	I	HV w/ST	“smart”	Address 2
7	—	9	13	14	A1	I	HV w/ST	“smart”	Address 1
8	8	10	14	15	V <sub>DD</sub>	—	P	—	Positive Power Supply Input
—	—	—	—	11	NC	—	—	—	No Connection
9	9	11	—	17	EP	—	—	—	Exposed Pad ( <a href="#">Note 2</a> )

**Legend:** HV w/ST = High Voltage tolerant input (with Schmitt trigger input)  
 A = Analog pins (Potentiometer terminals) I = digital input (high Z)  
 O = digital output I/O = Input / Output  
 P = Power

- Note 1:** The pin’s “smart” pull-up shuts off while the pin is forced low. This is done to reduce the standby and shut-down current.
- 2:** The DFN and QFN packages have a contact on the bottom of the package. This contact is conductively connected to the die substrate, and therefore should be unconnected or connected to the same ground as the device’s V<sub>SS</sub> pin.

# MCP454X/456X/464X/466X

---

## 3.1 High Voltage Command / Address 0 (HVC/A0)

The HVC/A0 pin is the Address 0 input for the I<sup>2</sup>C interface as well as the High Voltage Command pin. At the device's POR/BOR, the value of the A0 address bit is latched. This input, along with the A2 and A1 pins, completes the device address. This allows up to eight MCP45xx/46xx devices on a single I<sup>2</sup>C bus.

During normal operation, the the voltage on this pin determines if the I<sup>2</sup>C command is a normal command or a High Voltage command (when HVC/A0 = V<sub>IHH</sub>).

## 3.2 Serial Clock (SCL)

The SCL pin is the serial interfaces Serial Clock pin. This pin is connected to the Host Controllers SCL pin. The MCP45XX/46XX is a slave device, so its SCL pin accepts only external clock signals.

## 3.3 Serial Data (SDA)

The SDA pin is the serial interfaces Serial Data pin. This pin is connected to the Host Controllers SDA pin. The SDA pin is an open-drain N-channel driver.

## 3.4 Ground (V<sub>SS</sub>)

The V<sub>SS</sub> pin is the device ground reference.

## 3.5 Potentiometer Terminal B

The terminal B pin is connected to the internal potentiometer's terminal B.

The potentiometer's terminal B is the fixed connection to the Zero Scale wiper value of the digital potentiometer. This corresponds to a wiper value of 0x00 for both 7-bit and 8-bit devices.

The terminal B pin does not have a polarity relative to the terminal W or A pins. The terminal B pin can support both positive and negative current. The voltage on terminal B must be between V<sub>SS</sub> and V<sub>DD</sub>.

MCP46XX devices have two terminal B pins, one for each resistor network.

## 3.6 Potentiometer Wiper (W) Terminal

The terminal W pin is connected to the internal potentiometer's terminal W (the wiper). The wiper terminal is the adjustable terminal of the digital potentiometer. The terminal W pin does not have a polarity relative to terminals A or B pins. The terminal W pin can support both positive and negative current. The voltage on terminal W must be between V<sub>SS</sub> and V<sub>DD</sub>.

MCP46XX devices have two terminal W pins, one for each resistor network.

## 3.7 Potentiometer Terminal A

The terminal A pin is available on the MCP4XX1 devices, and is connected to the internal potentiometer's terminal A.

The potentiometer's terminal A is the fixed connection to the Full-Scale wiper value of the digital potentiometer. This corresponds to a wiper value of 0x100 for 8-bit devices or 0x80 for 7-bit devices.

The terminal A pin does not have a polarity relative to the terminal W or B pins. The terminal A pin can support both positive and negative current. The voltage on terminal A must be between V<sub>SS</sub> and V<sub>DD</sub>.

The terminal A pin is not available on the MCP4XX2 devices, and the internally terminal A signal is floating.

MCP46X1 devices have two terminal A pins, one for each resistor network.

## 3.8 Write Protect ( $\overline{WP}$ )

The  $\overline{WP}$  pin is used to force the nonvolatile memory to be write protected.

## 3.9 Address 2 (A2)

The A2 pin is the I<sup>2</sup>C interface's Address 2 pin. Along with the A1 and A0 pins, up to 8 MCP45XX/46XX devices can be on a single I<sup>2</sup>C bus.

## 3.10 Address 1 (A1)

The A1 pin is the I<sup>2</sup>C interface's Address 1 pin. Along with the A2 and A0 pins, up to 8 MCP45XX/46XX devices can be on a single I<sup>2</sup>C bus.

## 3.11 Positive Power Supply Input (V<sub>DD</sub>)

The V<sub>DD</sub> pin is the device's positive power supply input. The input power supply is relative to V<sub>SS</sub>.

While the device V<sub>DD</sub> < V<sub>min</sub> (2.7V), the electrical performance of the device may not meet the data sheet specifications.

## 3.12 No Connect (NC)

These pins should be either connected to V<sub>DD</sub> or V<sub>SS</sub>.

## 3.13 Exposed Pad (EP)

This pad is conductively connected to the device's substrate. This pad should be tied to the same potential as the V<sub>SS</sub> pin (or left unconnected). This pad could be used to assist as a heat sink for the device when connected to a PCB heat sink.

## 4.0 FUNCTIONAL OVERVIEW

This Data Sheet covers a family of thirty-two Digital Potentiometer and Rheostat devices that will be referred to as MCP4XXX. The MCP4XX1 devices are the Potentiometer configuration, while the MCP4XX2 devices are the Rheostat configuration.

As the [Device Block Diagram](#) shows, there are four main functional blocks. These are:

- [POR/BOR Operation](#)
- [Memory Map](#)
- [Resistor Network](#)
- [Serial Interface \(I<sup>2</sup>C\)](#)

The POR/BOR operation and the Memory Map are discussed in this section and the Resistor Network and I<sup>2</sup>C operation are described in their own sections. The [Device Commands](#) commands are discussed in [Section 7.0 “Device Commands”](#).

### 4.1 POR/BOR Operation

The Power-on Reset is the case where the device has power applied to it, starting from the  $V_{SS}$  level. The Brown-out Reset occurs when power is applied to the device, and that power (voltage) drops below the specified range.

The device's RAM retention voltage ( $V_{RAM}$ ) is lower than the POR/BOR voltage trip point ( $V_{POR}/V_{BOR}$ ). The maximum  $V_{POR}/V_{BOR}$  voltage is less than 1.8V.

When  $V_{POR}/V_{BOR} < V_{DD} < 2.7V$ , the electrical performance may not meet the data sheet specifications. In this region, the device is capable of reading and writing to its EEPROM and incrementing, decrementing, reading and writing to its volatile memory if the proper serial command is executed.

#### 4.1.1 POWER-ON RESET

When the device powers up, the device  $V_{DD}$  will cross the  $V_{POR}/V_{BOR}$  voltage. Once the  $V_{DD}$  voltage crosses the  $V_{POR}/V_{BOR}$  voltage the following happens:

- Volatile wiper register is loaded with value in the corresponding nonvolatile wiper register
- The TCON register is loaded its default value
- The device is capable of digital operation

#### 4.1.2 BROWN-OUT RESET

When the device powers down, the device  $V_{DD}$  will cross the  $V_{POR}/V_{BOR}$  voltage.

Once the  $V_{DD}$  voltage decreases below the  $V_{POR}/V_{BOR}$  voltage the following happens:

- Serial Interface is disabled
- EEPROM Writes are disabled

If the  $V_{DD}$  voltage decreases below the  $V_{RAM}$  voltage the following happens:

- Volatile wiper registers may become corrupted
- TCON register may become corrupted

As the voltage recovers above the  $V_{POR}/V_{BOR}$  voltage see [Section 4.1.1 “Power-on Reset”](#).

Serial commands not completed due to a brown-out condition may cause the memory location (volatile and nonvolatile) to become corrupted.

### 4.2 Memory Map

The device memory is 16 locations that are 9-bits wide (16x9 bits). This memory space contains both volatile and nonvolatile locations (see [Table 4-1](#)).

**TABLE 4-1: MEMORY MAP**

Address	Function	Memory Type
00h	Volatile Wiper 0	RAM
01h	Volatile Wiper 1	RAM
02h	Nonvolatile Wiper 0	EEPROM
03h	Nonvolatile Wiper 1	EEPROM
04h	Volatile TCON Register	RAM
05h	Status Register	RAM
06h	Data EEPROM	EEPROM
07h	Data EEPROM	EEPROM
08h	Data EEPROM	EEPROM
09h	Data EEPROM	EEPROM
0Ah	Data EEPROM	EEPROM
0Bh	Data EEPROM	EEPROM
0Ch	Data EEPROM	EEPROM
0Dh	Data EEPROM	EEPROM
0Eh	Data EEPROM	EEPROM
0Fh	Data EEPROM	EEPROM

# MCP454X/456X/464X/466X

## 4.2.1 NONVOLATILE MEMORY (EEPROM)

This memory can be grouped into two uses of nonvolatile memory. These are:

- [General Purpose Registers](#)
- [Nonvolatile Wiper Registers](#)

The nonvolatile wipers starts functioning below the devices  $V_{POR}/V_{BOR}$  trip point.

### 4.2.1.1 General Purpose Registers

These locations allow the user to store up to 10 (9-bit) locations worth of information.

### 4.2.1.2 Nonvolatile Wiper Registers

These locations contain the wiper values that are loaded into the corresponding volatile wiper register whenever the device has a POR/BOR event. There are up to two registers, one for each resistor network.

The nonvolatile wiper register enables stand-alone operation of the device (without Microcontroller control) after being programmed to the desired value.

### 4.2.1.3 Factory Initialization of Nonvolatile Memory (EEPROM)

The Nonvolatile Wiper values will be initialized to mid-scale value. This is shown in [Table 4-2](#).

The General purpose EEPROM memory will be programmed to a default value of 0xFF.

It is good practice in the manufacturing flow to configure the device to your desired settings.

**TABLE 4-2: DEFAULT FACTORY SETTINGS SELECTION**

Resistance Code	Typical $R_{AB}$ Value	Default POR Wiper Setting	Wiper Code		WiperLock™ Technology and Write Protect Setting
			8-bit	7-bit	
-502	5.0 kΩ	Mid-scale	80h	40h	Disabled
-103	10.0 kΩ	Mid-scale	80h	40h	Disabled
-503	50.0 kΩ	Mid-scale	80h	40h	Disabled
-104	100.0 kΩ	Mid-scale	80h	40h	Disabled

## 4.2.1.4 Special Features

There are three nonvolatile bits that are not directly mapped into the address space. These bits control the following functions:

- EEPROM Write Protect
- WiperLock Technology for Nonvolatile Wiper 0
- WiperLock Technology for Nonvolatile Wiper 1

The operation of WiperLock Technology is discussed in [Section 5.3](#). The state of the WLO, WL1, and WP bits is reflected in the STATUS register (see [Register 4-1](#)).

### EEPROM Write Protect

All internal EEPROM memory can be Write Protected. When EEPROM memory is Write Protected, Write commands to the internal EEPROM are prevented.

Write Protect ( $\overline{WP}$ ) can be enabled/disabled by two methods. These are:

- External  $\overline{WP}$  Hardware pin (MCP46X1 devices only)
- Nonvolatile configuration bit

High Voltage commands are required to enable and disable the nonvolatile WP bit. These commands are shown in [Section 7.8 “Modify Write Protect or WiperLock Technology \(High Voltage\)”](#).

To write to EEPROM, both the external  $\overline{WP}$  pin and the internal WP EEPROM bit must be disabled. Write Protect does not block commands to the volatile registers.

## 4.2.2 VOLATILE MEMORY (RAM)

There are four Volatile Memory locations. These are:

- Volatile Wiper 0
- Volatile Wiper 1 (Dual Resistor Network devices only)
- Status Register
- Terminal Control (TCON) Register

The volatile memory starts functioning at the RAM retention voltage ( $V_{RAM}$ ).

# MCP454X/456X/464X/466X

## 4.2.2.1 Status (STATUS) Register

This register contains four status bits. These bits show the state of the WiperLock bits, the Write Protect bit, and if an EEPROM write cycle is active. The STATUS register can be accessed via the READ commands.

[Register 4-1](#) describes each STATUS register bit.

The STATUS register is placed at Address 05h.

### REGISTER 4-1: STATUS REGISTER (ADDRESS = 0x05)

R-1	R-1	R-1	R-1	R-1	R-0	R-x	R-x	R-x
D8:D4					EEWA	WL1 <sup>(1)</sup>	WL0 <sup>(1)</sup>	WP <sup>(1)</sup>
bit 7					bit 0			

#### Legend:

R = Readable bit	W = Writable bit	U = Unimplemented bit, read as '0'
-n = Value at POR	'1' = Bit is set	'0' = Bit is cleared      x = Bit is unknown

bit 8-4      **D8:D4:** Reserved. Forced to "1"

bit 3      **EEWA:** EEPROM Write Active Status bit

This bit indicates if the EEPROM Write Cycle is occurring.

1 = An EEPROM Write cycle is currently occurring. Only serial commands to the Volatile memory locations are allowed (addresses 00h, 01h, 04h, and 05h)

0 = An EEPROM Write cycle is NOT currently occurring

bit 2      **WL1:** WiperLock Status bit for Resistor Network 1 (Refer to [Section 5.3 "WiperLock™ Technology"](#) for further information)

WiperLock (WL) prevents the Volatile and Nonvolatile Wiper 1 addresses and the TCON register bits R1HW, R1A, R1W, and R1B from being written to. High Voltage commands are required to enable and disable WiperLock Technology.

1 = Wiper and TCON register bits R1HW, R1A, R1W, and R1B of Resistor Network 1 (Pot 1) are "Locked" (Write Protected)

0 = Wiper and TCON of Resistor Network 1 (Pot 1) can be modified

**Note:** The WL1 bit always reflects the result of the last programming cycle to the nonvolatile WL1 bit. After a POR or BOR event, the WL1 bit is loaded with the nonvolatile WL1 bit value.

bit 1      **WL0:** WiperLock Status bit for Resistor Network 0 (Refer to [Section 5.3 "WiperLock™ Technology"](#) for further information)

The WiperLock Technology bits (WLx) prevents the Volatile and Nonvolatile Wiper 0 addresses and the TCON register bits R0HW, R0A, R0W, and R0B from being written to. High Voltage commands are required to enable and disable WiperLock Technology.

1 = Wiper and TCON register bits R0HW, R0A, R0W, and R0B of Resistor Network 0 (Pot 0) are "Locked" (Write Protected)

0 = Wiper and TCON of Resistor Network 0 (Pot 0) can be modified

**Note:** The WL0 bit always reflects the result of the last programming cycle to the nonvolatile WL0 bit. After a POR or BOR event, the WL0 bit is loaded with the nonvolatile WL0 bit value.

**Note 1:** Requires a High Voltage command to modify the state of this bit (for nonvolatile devices only). This bit is not directly written, but reflects the system state (for this feature).

# MCP454X/456X/464X/466X

---

## REGISTER 4-1: STATUS REGISTER (ADDRESS = 0x05) (CONTINUED)

- bit 0      **WP:** EEPROM Write Protect Status bit (Refer to the section [EEPROM Write Protect](#) for further information)
- This bit indicates the status of the write protection on the EEPROM memory. When Write Protect is enabled, writes to all nonvolatile memory are prevented. This includes the General Purpose EEPROM memory, and the nonvolatile Wiper registers. Write Protect does not block modification of the volatile wiper register values or the volatile TCON register value (via Increment, Decrement, or Write commands).
- This status bit is an OR of the devices Write Protect pin ( $\overline{WP}$ ) and the internal nonvolatile WP bit. High Voltage commands are required to enable and disable the internal WP EEPROM bit.
- 1 = EEPROM memory is Write Protected
  - 0 = EEPROM memory can be written

**Note 1:** Requires a High Voltage command to modify the state of this bit (for nonvolatile devices only). This bit is not directly written, but reflects the system state (for this feature).



## 4.2.2.2 Terminal Control (TCON) Register

This register contains eight control bits. Four bits are for Wiper 0, and four bits are for Wiper 1. [Register 4-2](#) describes each bit of the TCON register.

The state of each resistor network terminal connection is individually controlled. That is, each terminal connection (A, B and W) can be individually connected/disconnected from the resistor network. This allows the system to minimize the currents through the digital potentiometer.

The value that is written to this register will appear on the resistor network terminals when the serial command has completed.

When the WL1 bit is enabled, writes to the TCON register bits R1HW, R1A, R1W, and R1B are inhibited.

When the WL0 bit is enabled, writes to the TCON register bits R0HW, R0A, R0W, and R0B are inhibited.

On a POR/BOR this register is loaded with 1FFh (9-bits), for all terminals connected. The Host Controller needs to detect the POR/BOR event and then update the Volatile TCON register value.

Additionally, there is a bit which enables the operation of General Call commands.

# MCP454X/456X/464X/466X

## REGISTER 4-2: TCON BITS (ADDRESS = 0x04) <sup>(1)</sup>

R/W-1	R/W-1	R/W-1	R/W-1	R/W-1	R/W-1	R/W-1	R/W-1	R/W-1
GCEN	R1HW	R1A	R1W	R1B	R0HW	R0A	R0W	R0B
bit 8								bit 0

### Legend:

R = Readable bit      W = Writable bit      U = Unimplemented bit, read as '0'  
 -n = Value at POR      '1' = Bit is set      '0' = Bit is cleared      x = Bit is unknown

- bit 8      **GCEN:** General Call Enable bit  
 This bit specifies if I<sup>2</sup>C General Call commands are accepted  
 1 = Enable Device to "Accept" the General Call Address (0000h)  
 0 = The General Call Address is disabled
- bit 7      **R1HW:** Resistor 1 Hardware Configuration Control bit  
 This bit forces Resistor 1 into the "shutdown" configuration of the Hardware pin  
 1 = Resistor 1 is NOT forced to the hardware pin "shutdown" configuration  
 0 = Resistor 1 is forced to the hardware pin "shutdown" configuration
- bit 6      **R1A:** Resistor 1 Terminal A (P1A pin) Connect Control bit  
 This bit connects/disconnects the Resistor 1 Terminal A to the Resistor 1 Network  
 1 = P1A pin is connected to the Resistor 1 Network  
 0 = P1A pin is disconnected from the Resistor 1 Network
- bit 5      **R1W:** Resistor 1 Wiper (P1W pin) Connect Control bit  
 This bit connects/disconnects the Resistor 1 Wiper to the Resistor 1 Network  
 1 = P1W pin is connected to the Resistor 1 Network  
 0 = P1W pin is disconnected from the Resistor 1 Network
- bit 4      **R1B:** Resistor 1 Terminal B (P1B pin) Connect Control bit  
 This bit connects/disconnects the Resistor 1 Terminal B to the Resistor 1 Network  
 1 = P1B pin is connected to the Resistor 1 Network  
 0 = P1B pin is disconnected from the Resistor 1 Network
- bit 3      **R0HW:** Resistor 0 Hardware Configuration Control bit  
 This bit forces Resistor 0 into the "shutdown" configuration of the Hardware pin  
 1 = Resistor 0 is NOT forced to the hardware pin "shutdown" configuration  
 0 = Resistor 0 is forced to the hardware pin "shutdown" configuration
- bit 2      **R0A:** Resistor 0 Terminal A (P0A pin) Connect Control bit  
 This bit connects/disconnects the Resistor 0 Terminal A to the Resistor 0 Network  
 1 = P0A pin is connected to the Resistor 0 Network  
 0 = P0A pin is disconnected from the Resistor 0 Network
- bit 1      **R0W:** Resistor 0 Wiper (P0W pin) Connect Control bit  
 This bit connects/disconnects the Resistor 0 Wiper to the Resistor 0 Network  
 1 = P0W pin is connected to the Resistor 0 Network  
 0 = P0W pin is disconnected from the Resistor 0 Network
- bit 0      **R0B:** Resistor 0 Terminal B (P0B pin) Connect Control bit  
 This bit connects/disconnects the Resistor 0 Terminal B to the Resistor 0 Network  
 1 = P0B pin is connected to the Resistor 0 Network  
 0 = P0B pin is disconnected from the Resistor 0 Network

**Note 1:** These bits do not affect the wiper register values.

## 5.0 RESISTOR NETWORK

The Resistor Network has either 7-bit or 8-bit resolution. Each Resistor Network allows zero scale to full-scale connections. Figure 5-1 shows a block diagram for the resistive network of a device.

The Resistor Network is made up of several parts. These include:

- Resistor Ladder
- Wiper
- Shutdown (Terminal Connections)

Devices have either one or two resistor networks. These are referred to as Pot 0 and Pot 1.

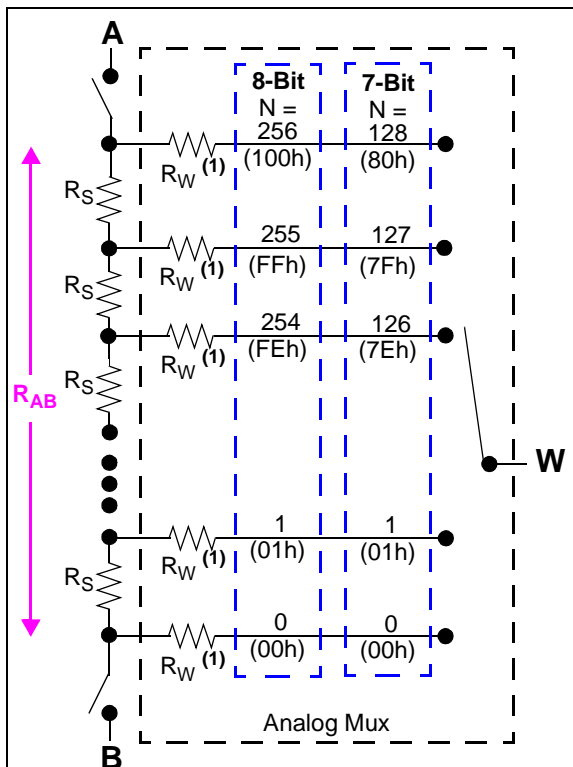

**Note 1:** The wiper resistance is dependent on several factors including, wiper code, device  $V_{DD}$ , Terminal voltages (on A, B, and W), and temperature. Also for the same conditions, each tap selection resistance has a small variation. This  $R_W$  variation has greater effects on some specifications (such as INL) for the smaller resistance devices ( $5.0\text{ k}\Omega$ ) compared to larger resistance devices ( $100.0\text{ k}\Omega$ ).

**FIGURE 5-1:** Resistor Block Diagram.

## 5.1 Resistor Ladder Module

The resistor ladder is a series of equal value resistors ( $R_S$ ) with a connection point (tap) between the two resistors. The total number of resistors in the series (ladder) determines the  $R_{AB}$  resistance (see Figure 5-1). The end points of the resistor ladder are connected to analog switches which are connected to the device Terminal A and Terminal B pins. The  $R_{AB}$  (and  $R_S$ ) resistance has small variations over voltage and temperature.

For an 8-bit device, there are 256 resistors in a string between terminal A and terminal B. The wiper can be set to tap onto any of these 256 resistors thus providing 257 possible settings (including terminal A and terminal B).

For a 7-bit device, there are 128 resistors in a string between terminal A and terminal B. The wiper can be set to tap onto any of these 128 resistors thus providing 129 possible settings (including terminal A and terminal B).

Equation 5-1 shows the calculation for the step resistance.

### EQUATION 5-1: $R_S$ CALCULATION

$R_S = \frac{R_{AB}}{(256)}$	8-bit Device
-----	
$R_S = \frac{R_{AB}}{(128)}$	7-bit Device

# MCP454X/456X/464X/466X

## 5.2 Wiper

Each tap point (between the  $R_S$  resistors) is a connection point for an analog switch. The opposite side of the analog switch is connected to a common signal which is connected to the Terminal W (Wiper) pin.

A value in the volatile wiper register selects which analog switch to close, connecting the W terminal to the selected node of the resistor ladder.

The wiper can connect directly to Terminal B or to Terminal A. A zero-scale connection, connects the Terminal W (wiper) to Terminal B (wiper setting of 000h). A full-scale connection, connects the Terminal W (wiper) to Terminal A (wiper setting of 100h or 80h). In these configurations, the only resistance between the Terminal W and the other Terminal (A or B) is that of the analog switches.

A wiper setting value greater than full-scale (wiper setting of 100h for 8-bit device or 80h for 7-bit devices) will also be a Full-Scale setting (Terminal W (wiper) connected to Terminal A). [Table 5-1](#) illustrates the full wiper setting map.

[Equation 5-2](#) illustrates the calculation used to determine the resistance between the wiper and terminal B.

### EQUATION 5-2: $R_{WB}$ CALCULATION

$$R_{WB} = \frac{R_{AB}N}{(256)} + R_W \quad \text{8-bit Device}$$

N = 0 to 256 (decimal)

---

$$R_{WB} = \frac{R_{AB}N}{(128)} + R_W \quad \text{7-bit Device}$$

N = 0 to 128 (decimal)

**TABLE 5-1: VOLATILE WIPER VALUE VS. WIPER POSITION MAP**

Wiper Setting		Properties
7-bit Pot	8-bit Pot	
3FFh 081h	3FFh 101h	Reserved (Full-Scale (W = A)), Increment and Decrement commands ignored
080h	100h	Full-Scale (W = A), Increment commands ignored
07Fh 041h	0FFh 081	W = N
040h	080h	W = N (Mid-Scale)
03Fh 001h	07Fh 001	W = N
000h	000h	Zero Scale (W = B) Decrement command ignored

## 5.3 WiperLock™ Technology

The MCP4XXX device's WiperLock technology allows application-specific calibration settings to be secured in the EEPROM without requiring the use of an additional write-protect pin. There are two WiperLock Technology configuration bits (WL0 and WL1). These bits prevent the Nonvolatile and Volatile addresses and bits for the specified resistor network from being written.

The WiperLock technology prevents the serial commands from doing the following:

- Changing a volatile wiper value
- Writing to a nonvolatile wiper memory location
- Changing the volatile TCON register value

For either Resistor Network 0 or Resistor Network 1 (Potx), the WLx bit controls the following:

- Nonvolatile Wiper Register
- Volatile Wiper Register
- Volatile TCON register bits RxHW, RxA, RxW, and RxB

High Voltage commands are required to enable and disable WiperLock. Please refer to the [Modify Write Protect or WiperLock Technology \(High Voltage\)](#) command for operation.

### 5.3.1 POR/BOR OPERATION WHEN WIPERLOCK TECHNOLOGY ENABLED

The WiperLock Technology state is not affected by a POR/BOR event. A POR/BOR event will load the Volatile Wiper register value with the Nonvolatile Wiper register value, refer to [Section 4.1](#).

**TABLE 5-2: DEFAULT FACTORY SETTINGS SELECTION**

Resistance Code	Typical $R_{AB}$ Value	Factory Default POR Wiper Setting	Wiper Code	
			8-bit	7-bit
-502	5.0 k $\Omega$	Mid-scale	80h	40h
-103	10.0 k $\Omega$	Mid-scale	80h	40h
-503	50.0 k $\Omega$	Mid-scale	80h	40h
-104	100.0 k $\Omega$	Mid-scale	80h	40h

## 5.4 Shutdown

Shutdown is used to minimize the device's current consumption. The MCP4XXX achieves this through the [Terminal Control Register \(TCON\)](#).

### 5.4.1 TERMINAL CONTROL REGISTER (TCON)

The Terminal Control (TCON) register is a volatile register used to configure the connection of each resistor network terminal pin (A, B, and W) to the Resistor Network. This bits are described in [Register 4-2](#).

When the RxHW bit is a "0", the selected resistor network is forced into the following state:

- The PxA terminal is disconnected
- The PxW terminal is simultaneously connected to the PxB terminal (see [Figure 5-2](#))
- The Serial Interface is NOT disabled, and all Serial Interface activity is executed
- Any EEPROM write cycles are completed

Alternate low power configurations may be achieved with the RxA, RxW, and RxB bits.

### 5.4.2 INTERACTION OF RxHW BIT AND RxA, RxW, AND RxB BITS (TCON REGISTER)

Using the TCON bits allows each resistor network (Pot 0 and Pot 1) to be individually "shutdown".

The state of the RxHW bit does NOT corrupt the other bit values in the TCON register nor the value of the Volatile Wiper Registers. When the Shutdown mode is exited (RxHW changes state from "0" to "1"):

- The device returns to the Wiper setting specified by the Volatile Wiper value
- The RxA, RxB, and RxW bits return to controlling the terminal connection state of that resistor network

**Note 1:** The RxHW bits are identical to the RxHW bits of the MCP41XX/42XX devices. The MCP42XX devices also have a  $\overline{\text{SHDN}}$  pin which forces the resistor network into the same state as that resistor networks RxHW bit.

**2:** When RxHW = "0", the state of the TCON register RxA, RxW, and RxB bits is overridden (ignored). When the state of the RxHW bit returns to "1", the TCON register RxA, RxW, and RxB bits return to controlling the terminal connection state. In other words, the RxHW bit does not corrupt the state of the RxA, RxW, and RxB bits.



**FIGURE 5-2:** Resistor Network Shutdown Configuration.

# MCP454X/456X/464X/466X

---

NOTES:

## 6.0 SERIAL INTERFACE (I<sup>2</sup>C)

The MCP45XX/46XX devices support the I<sup>2</sup>C serial protocol. The MCP45XX/46XX I<sup>2</sup>C's module operates in Slave mode (does not generate the serial clock).

Figure 6-1 shows a typical I<sup>2</sup>C Interface connection. All I<sup>2</sup>C interface signals are high-voltage tolerant.

The MCP45XX/46XX devices use the two-wire I<sup>2</sup>C serial interface. This interface can operate in standard, fast or High-Speed mode. A device that sends data onto the bus is defined as transmitter, and a device receiving data as receiver. The bus has to be controlled by a master device which generates the serial clock (SCL), controls the bus access and generates the START and STOP conditions. The MCP45XX/46XX device works as slave. Both master and slave can operate as transmitter or receiver, but the master device determines which mode is activated. Communication is initiated by the master (microcontroller) which sends the START bit, followed by the slave address byte. The first byte transmitted is always the slave address byte, which contains the device code, the address bits, and the R/W bit.

Refer to the Phillips I<sup>2</sup>C document for more details of the I<sup>2</sup>C specifications.



**FIGURE 6-1:** Typical I<sup>2</sup>C Interface Block Diagram.

## 6.1 Signal Descriptions

The I<sup>2</sup>C interface uses up to five pins (signals). These are:

- SDA (Serial Data)
- SCL (Serial Clock)
- A0 (Address 0 bit)
- A1 (Address 1 bit)
- A2 (Address 2 bit)

### 6.1.1 SERIAL DATA (SDA)

The Serial Data (SDA) signal is the data signal of the device. The value on this pin is latched on the rising edge of the SCL signal when the signal is an input.

With the exception of the START and STOP conditions, the high or low state of the SDA pin can only change when the clock signal on the SCL pin is low. During the high period of the clock the SDA pin's value (high or low) must be stable. Changes in the SDA pin's value while the SCL pin is HIGH will be interpreted as a START or a STOP condition.

### 6.1.2 SERIAL CLOCK (SCL)

The Serial Clock (SCL) signal is the clock signal of the device. The rising edge of the SCL signal latches the value on the SDA pin. The MCP45XX/46XX supports three I<sup>2</sup>C interface clock modes:

- Standard Mode: clock rates up to 100 kHz
- Fast Mode: clock rates up to 400 kHz
- High-Speed Mode (HS mode): clock rates up to 3.4 MHz

The MCP4XXX will not stretch the clock signal (SCL) since memory read accesses occur fast enough.

Depending on the clock rate mode, the interface will display different characteristics.

### 6.1.3 THE ADDRESS BITS (A2:A1:A0)

There are up to three hardware pins used to specify the device address. The number of address pins is determined by the part number.

Address 0 is multiplexed with the High Voltage Command (HVC) function. So the state of A0 is latched on the MCP4XXX's POR/BOR event.

The state of the A2 and A1 pins should be static, that is they should be tied high or tied low.

#### 6.1.3.1 The High Voltage Command (HVC) Signal

The High Voltage Command (HVC) signal is multiplexed with Address 0 (A0) and is used to indicate that the command, or sequence of commands, are in the High Voltage mode. High Voltage commands allow the device's WiperLock Technology and write protect features to be enabled and disabled.

The HVC pin has an internal resistor connection to the MCP45XX/46XXs internal V<sub>DD</sub> signal.

# MCP454X/456X/464X/466X

## 6.2 I<sup>2</sup>C Operation

The MCP45XX/46XX's I<sup>2</sup>C module is compatible with the Philips I<sup>2</sup>C specification. The following lists some of the modules features:

- 7-bit slave addressing
- Supports three clock rate modes:
  - Standard mode, clock rates up to 100 kHz
  - Fast mode, clock rates up to 400 kHz
  - High-speed mode (HS mode), clock rates up to 3.4 MHz
- Support Multi-Master Applications
- General call addressing
- Internal weak pull-ups on interface signals

The I<sup>2</sup>C 10-bit addressing mode is not supported.

The Philips I<sup>2</sup>C specification only defines the field types, field lengths, timings, etc. of a frame. The frame *content* defines the behavior of the device. The frame content for the MCP4XXX is defined in [Section 7.0](#).

### 6.2.1 I<sup>2</sup>C BIT STATES AND SEQUENCE

[Figure 6-8](#) shows the I<sup>2</sup>C transfer sequence. The serial clock is generated by the master. The following definitions are used for the bit states:

- Start bit (S)
- Data bit
- Acknowledge (A) bit (driven low) / No Acknowledge ( $\bar{A}$ ) bit (not driven low)
- Repeated Start bit (Sr)
- Stop bit (P)

#### 6.2.1.1 Start Bit

The Start bit (see [Figure 6-2](#)) indicates the beginning of a data transfer sequence. The Start bit is defined as the SDA signal falling when the SCL signal is "High".



**FIGURE 6-2:** Start Bit.

#### 6.2.1.2 Data Bit

The SDA signal may change state while the SCL signal is Low. While the SCL signal is High, the SDA signal MUST be stable (see [Figure 6-5](#)).



**FIGURE 6-3:** Data Bit.

#### 6.2.1.3 Acknowledge (A) Bit

The A bit (see [Figure 6-4](#)) is typically a response from the receiving device to the transmitting device. Depending on the context of the transfer sequence, the A bit may indicate different things. Typically the Slave device will supply an A response after the Start bit and eight "data" bits have been received. An A bit has the SDA signal low.



**FIGURE 6-4:** Acknowledge Waveform.

#### Not A ( $\bar{A}$ ) Response

The  $\bar{A}$  bit has the SDA signal high. [Table 6-1](#) shows some of the conditions where the Slave Device will issue a Not A ( $\bar{A}$ ).

If an error condition occurs (such as an  $\bar{A}$  instead of A), then an START bit must be issued to reset the command state machine.

**TABLE 6-1: MCP45XX/MCP46XX A /  $\bar{A}$  RESPONSES**

Event	Acknowledge Bit Response	Comment
General Call	A	Only if GCEN bit is set
Slave Address valid	A	
Slave Address not valid	$\bar{A}$	
Device Memory Address and specified command (AD3:AD0 and C1:C0) are an invalid combination	$\bar{A}$	After device has received address and command
Communication during EEPROM write cycle	A	After device has received address and command, and valid conditions for EEPROM write
Bus Collision	N.A.	I <sup>2</sup> C Module Resets, or a "Don't Care" if the collision occurs on the Masters "Start bit".



# MCP454X/456X/464X/466X

## 6.2.1.4 Repeated Start Bit

The Repeated Start bit (see [Figure 6-5](#)) indicates the current Master Device wishes to continue communicating with the current Slave Device without releasing the I<sup>2</sup>C bus. The Repeated Start condition is the same as the Start condition, except that the Repeated Start bit follows a Start bit (with the Data bits + A bit) and not a Stop bit.

The Start bit is the beginning of a data transfer sequence and is defined as the SDA signal falling when the SCL signal is "High".

**Note 1:** A bus collision during the Repeated Start condition occurs if:

- SDA is sampled low when SCL goes from low to high.
- SCL goes low before SDA is asserted low. This may indicate that another master is attempting to transmit a data "1".



**FIGURE 6-5:** Repeat Start Condition Waveform.



**FIGURE 6-7:** Typical 8-Bit I<sup>2</sup>C Waveform Format.



**FIGURE 6-8:** I<sup>2</sup>C Data States and Bit Sequence.

## 6.2.1.5 Stop Bit

The Stop bit (see [Figure 6-6](#)) Indicates the end of the I<sup>2</sup>C Data Transfer Sequence. The Stop bit is defined as the SDA signal rising when the SCL signal is "High".

A Stop bit resets the I<sup>2</sup>C interface of all MCP4XXX devices.



**FIGURE 6-6:** Stop Condition Receive or Transmit Mode.

## 6.2.2 CLOCK STRETCHING

"Clock Stretching" is something that the receiving device can do, to allow additional time to "respond" to the "data" that has been received.

The MCP4XXX will not stretch the clock signal (SCL) since memory read accesses occur fast enough.

## 6.2.3 ABORTING A TRANSMISSION

If any part of the I<sup>2</sup>C transmission does not meet the command format, it is aborted. This can be intentionally accomplished with a START or STOP condition. This is done so that noisy transmissions (usually an extra START or STOP condition) are aborted before they corrupt the device.

# MCP454X/456X/464X/466X

## 6.2.4 ADDRESSING

The address byte is the first byte received following the START condition from the master device. The address contains four (or more) fixed bits and (up to) three user defined hardware address bits (pins A2, A1, and A0). These 7-bits address the desired I<sup>2</sup>C device. The A7:A4 address bits are fixed to "0101" and the device appends the value of following three address pins (A2, A1, A0). Address pins that are not present on the device are pulled up (a bit value of '1').

Since there are up to three address bits controlled by hardware pins, there may be up to eight MCP4XXX devices on the same I<sup>2</sup>C bus.

Figure 6-9 shows the slave address byte format, which contains the seven address bits. There is also a read/write bit. Table 6-2 shows the fixed address for device.

### Hardware Address Pins

The hardware address bits (A2, A1, and A0) correspond to the logic level on the associated address pins. This allows up to eight devices on the bus.

These pins have a weak pull-up enabled when the  $V_{DD} < V_{BOR}$ . The weak pull-up utilizes the "smart" pull-up technology and exhibits the same characteristics as the High-voltage tolerant I/O structure.

The state of the A0 address pin is latch on POR/BOR. This is required since High Voltage commands force this pin (HVC/A0) to the  $V_{IHH}$  level.



FIGURE 6-9: Slave Address Bits in the I<sup>2</sup>C Control Byte.

TABLE 6-2: DEVICE SLAVE ADDRESSES

Device	Address	Comment
MCP45X1	'0101 11'b + A0	Supports up to 2 devices. <b>Note 1</b>
MCP45X2	'0101 1'b + A1:A0	Supports up to 4 devices. <b>Note 1</b>
MCP46X1	'0101'b + A2:A1:A0	Supports up to 8 devices. <b>Note 1</b>
MCP46X2	'0101 1'b + A1:A0	Supports up to 4 devices. <b>Note 1</b>

**Note 1:** A0 is used for High-Voltage commands and the value is latched at POR.

## 6.2.5 SLOPE CONTROL

The MCP45XX/46XX implements slope control on the SDA output.

As the device transitions from HS mode to FS mode, the slope control parameter will change from the HS specification to the FS specification.

For Fast (FS) and High-Speed (HS) modes, the device has a spike suppression and a Schmidt trigger at SDA and SCL inputs.

# MCP454X/456X/464X/466X

## 6.2.6 HS MODE

The I<sup>2</sup>C specification requires that a high-speed mode device must be 'activated' to operate in high-speed (3.4 Mbit/s) mode. This is done by the Master sending a special address byte following the START bit. This byte is referred to as the high-speed Master Mode Code (HSMMC).

The MCP45XX/46XX device does not acknowledge this byte. However, upon receiving this command, the device switches to HS mode. The device can now communicate at up to 3.4 Mbit/s on SDA and SCL lines. The device will switch out of the HS mode on the next STOP condition.

The master code is sent as follows:

1. START condition (S)
2. High-Speed Master Mode Code (0000 1xxx),  
The xxx bits are unique to the high-speed (HS) mode Master.
3. No Acknowledge ( $\bar{A}$ )

After switching to the High-Speed mode, the next transferred byte is the I<sup>2</sup>C control byte, which specifies the device to communicate with, and any number of data bytes plus acknowledgements. The Master Device can then either issue a Repeated Start bit to address a different device (at High-Speed) or a Stop bit to return to Fast/Standard bus speed. After the Stop bit, any other Master Device (in a Multi-Master system) can arbitrate for the I<sup>2</sup>C bus.

See Figure 6-10 for an illustration of the HS mode command sequence.

For more information on the HS mode, or other I<sup>2</sup>C modes, please refer to the Phillips I<sup>2</sup>C specification.

### 6.2.6.1 Slope Control

The slope control on the SDA output is different between the Fast/Standard Speed and the High-Speed Clock modes of the interface.

### 6.2.6.2 Pulse Gobbler

The pulse gobbler on the SCL pin is automatically adjusted to suppress spikes < 10 ns during HS mode.



**FIGURE 6-10:** HS Mode Sequence.

# MCP454X/456X/464X/466X

## 6.2.7 GENERAL CALL

The General Call is a method that the “Master” device can communicate with all other “Slave” devices. In a Multi-Master application, the other Master devices are operating in Slave mode. The General Call address has two documented formats. These are shown in [Figure 6-11](#). We have added a MCP45XX/46XX format in this figure as well.

This will allow customers to have multiple I<sup>2</sup>C Digital Potentiometers on the bus and have them operate in a synchronous fashion (analogous to the DAC Sync pin functionality). If these MCP45XX/46XX 7-bit commands conflict with other I<sup>2</sup>C devices on the bus, then the customer will need two I<sup>2</sup>C busses and ensure that the devices are on the correct bus for their desired application functionality.

Dual Pot devices can not update both Pot0 and Pot1 from a single command. To address this, there are General Call commands for the Wiper 0, Wiper 1, and the TCON registers.

[Table 6-3](#) shows the General Call Commands. Three commands are specified by the I<sup>2</sup>C specification and are not applicable to the MCP45XX/46XX (so command is Not Acknowledged) The MCP45XX/46XX General Call Commands are Acknowledge. Any other command is Not Acknowledged.

<b>Note:</b> Only one General Call command per issue of the General Call control byte. Any additional General Call commands are ignored and Not Acknowledged.
---

**TABLE 6-3: GENERAL CALL COMMANDS**

7-bit Command (1, 2, 3)	Comment
'1000 00d'b	Write Next Byte (Third Byte) to Volatile Wiper 0 Register
'1001 00d'b	Write Next Byte (Third Byte) to Volatile Wiper 1 Register
'1100 00d'b	Write Next Byte (Third Byte) to TCON Register
'1000 010'b or '1000 011'b	Increment Wiper 0 Register
'1001 010'b or '1001 011'b	Increment Wiper 1 Register
'1000 100'b or '1000 101'b	Decrement Wiper 0 Register
'1001 100'b or '1001 101'b	Decrement Wiper 1 Register

- Note 1:** Any other code is Not Acknowledged. These codes may be used by other devices on the I<sup>2</sup>C bus.
- 2:** The 7-bit command always appends a “0” to form 8-bits. .
- 3:** “d” is the D8 bit for the 9-bit write value.

# MCP454X/456X/464X/466X



Reserved 7-bit Commands (By I<sup>2</sup>C Specification - Philips # 9398 393 40011, Ver. 2.1 January 2000)

- '0000 011'b - Reset and write programmable part of slave address by hardware.
- '0000 010'b - Write programmable part of slave address by hardware.
- '0000 000'b - NOT Allowed

MCP45XX/MCP46XX 7-bit Commands

- '1000 01x'b - Increment Wiper 0 Register.
- '1001 01x'b - Increment Wiper 1 Register.
- '1000 10x'b - Decrement Wiper 0 Register.
- '1001 10x'b - Decrement Wiper 1 Register.

The Following is a Microchip Extension to this General Call Format



MCP45XX/MCP46XX 7-bit Commands

- '1000 00d'b - Write Next Byte (Third Byte) to Volatile Wiper 0 Register.
- '1001 00d'b - Write Next Byte (Third Byte) to Volatile Wiper 1 Register.
- '1100 00d'b - Write Next Byte (Third Byte) to TCON Register.

The Following is a "Hardware General Call" Format



This indicates a "Hardware General Call" MCP45XX/MCP46XX will ignore this byte and all following bytes (and A), until a Stop bit (P) is encountered.

**FIGURE 6-11:** General Call Formats.

# MCP454X/456X/464X/466X

---

NOTES:

# MCP454X/456X/464X/466X

## 7.0 DEVICE COMMANDS

The MCP4XXX's I<sup>2</sup>C command formats are specified in this section. The I<sup>2</sup>C protocol does not specify how commands are formatted.

The MCP4XXX supports four basic commands. Depending on the location accessed, this determines the commands that are supported.

For the Volatile Wiper Registers, these commands are:

- Write Data
- Read Data
- Increment Data
- Decrement Data

For the Nonvolatile wiper EEPROM, general purpose data EEPROM, and the TCON Register these commands are:

- Write Data
- Read Data

These commands have formats for both a single command or continuous commands. These commands are shown in Table 7-1.

Each command has two operational states. The operational state determines if the device commands control the special features (Write Protect and Wiper-Lock Technology). These operational states are referred to as:

- Normal Serial Commands
- High-Voltage Serial Commands

**TABLE 7-1: I<sup>2</sup>C COMMANDS**

Command		# of Bit Clocks <sup>(1)</sup>	Operates on Volatile/ Nonvolatile memory
Operation	Mode		
Write Data	Single	29	Both
	Continuous	18n + 11	Volatile Only
Read Data	Single	29	Both
	Random	48	Both
	Continuous	18n + 11	Both <sup>(2)</sup>
Increment <sup>(3)</sup>	Single	20	Volatile Only
	Continuous	9n + 11	Volatile Only
Decrement <sup>(3)</sup>	Single	20	Volatile Only
	Continuous	9n + 11	Volatile Only

- Note 1:** "n" indicates the number of times the command operation is to be repeated.
- 2:** This command is useful to determine if a nonvolatile memory write cycle has completed.
- 3:** High Voltage Increment and Decrement commands on select nonvolatile memory locations enable/disable WiperLock Technology and the software Write Protect feature.

Normal serial commands are those where the HVC pin is driven to V<sub>IH</sub> or V<sub>IL</sub>. With High-Voltage Serial Commands, the HVC pin is driven to V<sub>IHH</sub>. In each mode, there are four possible commands.

Additionally, there are two commands used to enable or disable the special features (Write Protect and Wiper Lock Technology) of the device. The commands are special cases of the Increment and Decrement High-Voltage Serial Command.

Table 7-2 shows the supported commands for each memory location.

Table 7-3 shows an overview of all the device commands and their interaction with other device features.

## 7.1 Command Byte

The MCP4XXX's Command Byte has three fields: the Address, the Command Operation, and 2 Data bits, see Figure 7-1. Currently only one of the data bits is defined (D8).

The device memory is accessed when the Master sends a proper Command Byte to select the desired operation. The memory location getting accessed is contained in the Command Byte's AD3:AD0 bits. The action desired is contained in the Command Byte's C1:C0 bits, see Table 7-1. C1:C0 determines if the desired memory location will be read, written, Incremented (wiper setting +1) or Decrement (wiper setting -1). The Increment and Decrement commands are only valid on the volatile wiper registers, and in High Voltage commands to enable/disable WiperLock Technology and Software Write Protect.

If the Address bits and Command bits are not a valid combination, then the MCP4XXX will generate a Not Acknowledge pulse to indicate the invalid combination. The I<sup>2</sup>C Master device must then force a Start Condition to reset the MCP4XXX's I<sup>2</sup>C module.

D9 and D8 are the most significant bits for the digital potentiometer's wiper setting. The 8-bit devices utilize D8 as their MSb while the 7-bit devices utilize D7 (from the data byte) as it's MSb.



**FIGURE 7-1: Command Byte Format.**

# MCP454X/456X/464X/466X

**TABLE 7-2: MEMORY MAP AND THE SUPPORTED COMMANDS**

Address		Command Operation	Data (10-bits) <sup>(1)</sup>	Comment
Value	Function			
00h	Volatile Wiper 0	Write Data	nn nnnn nnnn	
		Read Data <sup>(3)</sup>	nn nnnn nnnn	
		Increment Wiper	—	
		Decrement Wiper	—	
01h	Volatile Wiper 1	Write Data	nn nnnn nnnn	
		Read Data <sup>(3)</sup>	nn nnnn nnnn	
		Increment Wiper	—	
		Decrement Wiper	—	
02h	Non Volatile Wiper 0	Write Data	nn nnnn nnnn	
		Read Data <sup>(3)</sup>	nn nnnn nnnn	
		High Voltage Increment	—	Wiper Lock 0 Disable
		High Voltage Decrement	—	Wiper Lock 0 Enable
03h	Non Volatile Wiper 1	Write Data	nn nnnn nnnn	
		Read Data <sup>(3)</sup>	nn nnnn nnnn	
		High Voltage Increment	—	Wiper Lock 1 Disable
		High Voltage Decrement	—	Wiper Lock 1 Enable
04h <sup>(2)</sup>	Volatile TCON Register	Write Data	nn nnnn nnnn	
		Read Data <sup>(3)</sup>	nn nnnn nnnn	
05h <sup>(2)</sup>	Status Register	Read Data <sup>(3)</sup>	nn nnnn nnnn	
06h <sup>(2)</sup>	Data EEPROM	Write Data	nn nnnn nnnn	
		Read Data <sup>(3)</sup>	nn nnnn nnnn	
07h <sup>(2)</sup>	Data EEPROM	Write Data	nn nnnn nnnn	
		Read Data <sup>(3)</sup>	nn nnnn nnnn	
08h <sup>(2)</sup>	Data EEPROM	Write Data	nn nnnn nnnn	
		Read Data <sup>(3)</sup>	nn nnnn nnnn	
09h <sup>(2)</sup>	Data EEPROM	Write Data	nn nnnn nnnn	
		Read Data <sup>(3)</sup>	nn nnnn nnnn	
0Ah <sup>(2)</sup>	Data EEPROM	Write Data	nn nnnn nnnn	
		Read Data <sup>(3)</sup>	nn nnnn nnnn	
0Bh <sup>(2)</sup>	Data EEPROM	Write Data	nn nnnn nnnn	
		Read Data <sup>(3)</sup>	nn nnnn nnnn	
0Ch <sup>(2)</sup>	Data EEPROM	Write Data	nn nnnn nnnn	
		Read Data <sup>(3)</sup>	nn nnnn nnnn	
0Dh <sup>(2)</sup>	Data EEPROM	Write Data	nn nnnn nnnn	
		Read Data <sup>(3)</sup>	nn nnnn nnnn	
0Eh <sup>(2)</sup>	Data EEPROM	Write Data	nn nnnn nnnn	
		Read Data <sup>(3)</sup>	nn nnnn nnnn	
0Fh	Data EEPROM	Write Data	nn nnnn nnnn	
		Read Data <sup>(3)</sup>	nn nnnn nnnn	
		High Voltage Increment	—	Write Protect Disable
		High Voltage Decrement	—	Write Protect Enable

- Note** 1: The Data Memory is only 9-bits wide, so the MSb is ignored by the device.  
 2: Increment or Decrement commands are invalid for these addresses.  
 3: I<sup>2</sup>C read operation will read 2 bytes, of which the 10-bits of data are contained within.



# MCP454X/456X/464X/466X

## 7.2 Data Byte

Only the Read Command and the Write Command have Data Byte(s).

The Write command concatenates the 8-bits of the Data Byte with the one data bit (D8) contained in the Command Byte to form 9-bits of data (D8:D0). The Command Byte format supports up to 9-bits of data so that the 8-bit resistor network can be set to Full-Scale (100h or greater). This allows wiper connections to Terminal A and to Terminal B. The D9 bit is currently unused.

## 7.3 Error Condition

If the four address bits received (AD3:AD0) and the two command bits received (C1:C0) are a valid combination, the MCP4XXX will Acknowledge the I<sup>2</sup>C bus.

If the address bits and command bits are an invalid combination, then the MCP4XXX will Not Acknowledge the I<sup>2</sup>C bus.

Once an error condition has occurred, any following commands are ignored until the I<sup>2</sup>C bus is reset with a Start Condition.

### 7.3.1 ABORTING A TRANSMISSION

A Restart or Stop condition in the expected data bit position will abort the current command sequence and data will not be written to the MCP4XXX.

**TABLE 7-3: COMMANDS**

Command Name	Writes Value in EEPROM	Operates on Volatile/ Nonvolatile memory	High Voltage (V <sub>IHH</sub> ) on HVC pin?	Impact on WiperLock or Write Protect	Works when Wiper is "locked"?
<b>Write Data</b>	Yes <sup>(1)</sup>	Both	—	unlocked <sup>(1)</sup>	No
<b>Read Data</b>	—	Both	—	unlocked <sup>(1)</sup>	No
<b>Increment Wiper</b>	—	Volatile Only	—	unlocked <sup>(1)</sup>	No
<b>Decrement Wiper</b>	—	Volatile Only	—	unlocked <sup>(1)</sup>	No
High Voltage <b>Write Data</b>	Yes	Both	Yes	unchanged	No
High Voltage <b>Read Data</b>	—	Both	Yes	unchanged	Yes
High Voltage <b>Increment Wiper</b>	—	Volatile Only	Yes	unchanged	No
High Voltage <b>Decrement Wiper</b>	—	Volatile Only	Yes	unchanged	No
<b>Modify Write Protect or WiperLock Technology (High Voltage) - Enable</b>	— <sup>(2)</sup>	Nonvolatile Only <sup>(2)</sup>	Yes	locked/protected <sup>(2)</sup>	Yes
<b>Modify Write Protect or WiperLock Technology (High Voltage) - Disable</b>	— <sup>(3)</sup>	Nonvolatile Only <sup>(3)</sup>	Yes	unlocked/unprotected <sup>(3)</sup>	Yes

**Note 1:** This command will only complete, if wiper is "unlocked" (WiperLock Technology is Disabled).

**2:** If the command is executed using address 02h or 03h, that corresponding wiper is locked or if with address 0Fh, then Write Protect is enabled.

**3:** If the command is executed using with address 02h or 03h, that corresponding wiper is unlocked or if with address 0Fh, then Write Protect is disabled.

# MCP454X/456X/464X/466X

## 7.4 Write Data Normal and High Voltage

The Write Command can be issued to both the Volatile and Nonvolatile memory locations. The format of the command, see [Figure 7-2](#), includes the I<sup>2</sup>C Control Byte, an A bit, the MCP4XXX Command Byte, an A bit, the MCP4XXX Data Byte, an A bit, and a Stop (or Restart) condition. The MCP4XXX generates the A /  $\bar{A}$  bits.

A Write command to a Volatile memory location changes that location after a properly formatted Write Command and the A /  $\bar{A}$  clock have been received.

A Write command to a Nonvolatile memory location will only start a write cycle after a properly formatted Write Command have been received and the Stop condition has occurred.

<b>Note:</b> Writes to certain memory locations will be dependant on the state of the WiperLock Technology bits and the Write Protect bit.
--

### 7.4.1 SINGLE WRITE TO VOLATILE MEMORY

For volatile memory locations, data is written to the MCP4XXX after every byte transfer (during the Acknowledge). If a Stop or Restart condition is generated during a data transfer (before the A), the data will not be written to the MCP4XXX. After the A bit, the master can initiate the next sequence with a Stop or Restart condition.

Refer to [Figure 7-2](#) for the byte write sequence.

### 7.4.2 SINGLE WRITE TO NONVOLATILE MEMORY

The sequence to write to a single nonvolatile memory location is the same as a single write to volatile memory with the exception that the EEPROM write cycle ( $t_{wc}$ ) is started after a properly formatted command, including the Stop bit, is received. After the Stop condition occurs, the serial interface may immediately be re-enabled by initiating a Start condition.

During an EEPROM write cycle, access to volatile memory (addresses 00h, 01h, 04h, and 05h) is allowed when using the appropriate command sequence. Commands that address nonvolatile memory are ignored until the EEPROM write cycle ( $t_{wc}$ ) completes. This allows the Host Controller to operate on the Volatile Wiper registers, the TCON register, and to Read the Status Register. The EEWA bit in the Status register indicates the status of an EEPROM Write Cycle.

Once a write command to a Nonvolatile memory location has been received, no other commands should be received before the Stop condition occurs.

[Figure 7-2](#) show the waveform for a single write.

### 7.4.3 CONTINUOUS WRITES TO VOLATILE MEMORY

A continuous write mode of operation is possible when writing to the volatile memory registers (address 00h, 01h, and 04h). This continuous write mode allows writes without a Stop or Restart condition or repeated transmissions of the I<sup>2</sup>C Control Byte. [Figure 7-3](#) shows the sequence for three continuous writes. The writes do not need to be to the same volatile memory address. The sequence ends with the master sending a STOP or RESTART condition.

### 7.4.4 CONTINUOUS WRITES TO NONVOLATILE MEMORY

If a continuous write is attempted on Nonvolatile memory, the missing Stop condition will cause the command to be an error condition ( $\bar{A}$ ). A Start bit is required to reset the command state machine.

### 7.4.5 THE HIGH VOLTAGE COMMAND (HVC) SIGNAL

The High Voltage Command (HVC) signal is multiplexed with Address 0 (A0) and is used to indicate that the command, or sequence of commands, are in the High Voltage operational state. High Voltage commands allow the device's WiperLock Technology and write protect features to be enabled and disabled.

The HVC pin has an internal resistor connection to the MCP45XX/46XXs internal V<sub>DD</sub> signal.

# MCP454X/456X/464X/466X



**FIGURE 7-2:** I<sup>2</sup>C Write Sequence.



**Note:** Only functions when writing the volatile wiper registers (AD3:AD0 = 00h, 01h, and 04h) or the TCON register

**FIGURE 7-3:** I<sup>2</sup>C Continuous Volatile Wiper Write.

# MCP454X/456X/464X/466X

---

## 7.5 Read Data Normal and High Voltage

The Read Command can be issued to both the Volatile and Nonvolatile memory locations. The format of the command, see [Figure 7-4](#), includes the Start condition, I<sup>2</sup>C Control Byte (with R/W bit set to “0”), A bit, MCP4XXX Command Byte, A bit, followed by a Repeated Start bit, I<sup>2</sup>C Control Byte (with R/W bit set to “1”), and the MCP4XXX transmitting the requested Data High Byte, and A bit, the Data Low Byte, the Master generating the  $\bar{A}$ , and Stop condition.

The I<sup>2</sup>C Control Byte requires the R/W bit equal to a logic one (R/W = 1) to generate a read sequence. The memory location read will be the last address contained in a valid write MCP4XXX Command Byte or address 00h if no write operations have occurred since the device was reset (Power-on Reset or Brown-out Reset).

During a write cycle (Write or High Voltage Write to a Nonvolatile memory location) the Read command can only read the Volatile memory locations. By reading the Status Register (04h), the Host Controller can determine when the write cycle has completed (via the state of the EEWA bit).

Read operations initially include the same address byte sequence as the write sequence (shown in [Figure 6-9](#)). This sequence is followed by another control byte (including the Start condition and Acknowledge) with the R/W bit equal to a logic one (R/W = 1) to indicate a read. The MCP4XXX will then transmit the data contained in the addressed register. This is followed by the master generating an A bit in preparation for more data, or an  $\bar{A}$  bit followed by a Stop. The sequence is ended with the master generating a Stop or Restart condition.

The internal address pointer is maintained. If this address pointer is for a nonvolatile memory address and the read control byte addresses the device during a Nonvolatile Write Cycle ( $t_{VWC}$ ) the device will respond with an  $\bar{A}$  bit.

### 7.5.1 SINGLE READ

[Figure 7-4](#) show the waveforms for a single read.

For **single reads** the master sends a STOP or RESTART condition after the data byte is sent from the slave.

#### 7.5.1.1 Random Read

[Figure 7-5](#) shows the sequence for a Random Reads.

Refer to [Figure 7-5](#) for the random byte read sequence.

### 7.5.2 CONTINUOUS READS

Continuous reads allows the device’s memory to be read quickly. Continuous reads are possible to all memory locations. If a nonvolatile memory write cycle is occurring, then Read commands may only access the volatile memory locations.

[Figure 7-6](#) shows the sequence for three continuous reads.

For **continuous reads**, instead of transmitting a Stop or Restart condition after the data transfer, the master reads the next data byte. The sequence ends with the master Not Acknowledging and then sending a Stop or Restart.

### 7.5.3 THE HIGH VOLTAGE COMMAND (HVC) SIGNAL

The High Voltage Command (HVC) signal is multiplexed with Address 0 (A0) and is used to indicate that the command, or sequence of commands, are in the High Voltage mode. High Voltage commands allow the device’s WiperLock Technology and write protect features to be enabled and disabled.

The HVC pin has an internal resistor connection to the MCP4XXXs internal V<sub>DD</sub> signal.

### 7.5.4 IGNORING AN I<sup>2</sup>C TRANSMISSION AND “FALLING OFF” THE BUS

The MCP4XXX expects to receive entire, valid I<sup>2</sup>C commands and will assume any command not defined as a valid command is due to a bus corruption and will enter a passive high condition on the SDA signal. All signals will be ignored until the next valid Start condition and Control Byte are received.

# MCP454X/456X/464X/466X



**FIGURE 7-4:** I<sup>2</sup>C Read (Last Memory Address Accessed).



**FIGURE 7-5:** I<sup>2</sup>C Random Read.

# MCP454X/456X/464X/466X



**FIGURE 7-6:** I<sup>2</sup>C Continuous Reads.

## 7.6 Increment Wiper Normal and High Voltage

The Increment Command provide a quick and easy method to modify the potentiometer's wiper by +1 with minimal overhead. The Increment Command will only function on the volatile wiper setting memory locations 00h and 01h. The Increment Command to Nonvolatile addresses will be ignored and will generate a  $\bar{A}$ .

**Note:** Table 7-2 shows the valid addresses for the Increment Wiper command. Other addresses are invalid.

When executing an Increment Command, the volatile wiper setting will be altered from n to n+1 for each Increment Command received. The value will increment up to 100h max on 8-bit devices and 80h on 7-bit devices. If multiple Increment Commands are received after the value has reached 100h (or 80h), the value will not be incremented further. Table 7-4 shows the Increment Command versus the current volatile wiper value.

The Increment Command will most commonly be performed on the Volatile Wiper locations until a desired condition is met. The value in the Volatile Wiper register would need to be read using a Read operation in order to write the new setting to the corresponding Nonvolatile wiper memory using a Write operation. The MCP4XXX is responsible for generating the A bits.

Refer to Figure 7-7 for the Increment Command sequence. The sequence is terminated by the Stop condition. So when executing a continuous command string, the Increment command can be followed by any other valid command. This means that writes do not need to be to the same volatile memory address.

**Note:** The command sequence can go from an increment to any other valid command for the specified address. Issuing an increment or decrement to a nonvolatile location will cause an error condition ( $\bar{A}$  will be generated).

The advantage of using an Increment Command instead of a read-modify-write series of commands is speed and simplicity. The wiper will transition after each Command Acknowledge when accessing the volatile wiper registers.

**TABLE 7-4: INCREMENT OPERATION VS. VOLATILE WIPER VALUE**

Current Wiper Setting		Wiper (W) Properties	Increment Command Operates?
7-bit Pot	8-bit Pot		
3FFh 081h	3FFh 101h	Reserved (Full-Scale (W = A))	No
080h	100h	Full-Scale (W = A)	No
07Fh 041h	0FFh 081	W = N	Yes
040h	080h	W = N (Mid-Scale)	
03Fh 001h	07Fh 001	W = N	
000h	000h	Zero Scale (W = B)	Yes

### 7.6.1 THE HIGH VOLTAGE COMMAND (HVC) SIGNAL

The High Voltage Command (HVC) signal is multiplexed with Address 0 (A0) and is used to indicate that the command, or sequence of commands, are in the High Voltage mode. Signals >  $V_{IH}$  (~8.5V) on the HVC/A0 pin puts MCP45XX/46XX devices into High Voltage mode. High Voltage commands allow the device's WiperLock Technology and write protect features to be enabled and disabled.

**Note:** There is a required delay after the HVC pin is driven to the  $V_{IH}$  level to the 1st edge of the SCL pin.

The HVC pin has an internal resistor connection to the MCP45XX/46XXs internal  $V_{DD}$  signal.



**FIGURE 7-7:**  $I^2C$  Increment Command Sequence.



# MCP454X/456X/464X/466X

## 7.7 Decrement Wiper Normal and High Voltage

The Decrement Command provide a quick and easy method to modify the potentiometer's wiper by -1 with minimal overhead. The Decrement Command will only function on the volatile wiper setting memory locations 00h and 01h. Decrement Commands to Nonvolatile addresses will be ignored and will generate an A bit.

**Note:** Table 7-2 shows the valid addresses for the Decrement Wiper command. Other addresses are invalid.

When executing a Decrement Command, the volatile wiper setting will be altered from n to n-1 for each Decrement Command received. The value will decrement down to 000h min. If multiple Decrement Commands are received after the value has reached 000h, the value will not be decremented further. Table 7-5 shows the Increment Command versus the current volatile wiper value.

The Decrement Command will most commonly be performed on the Volatile Wiper locations until a desired condition is met. The value in the Volatile Wiper register would need to be read using a Read operation in order to write the new setting to the corresponding Nonvolatile wiper memory using a Write operation. The MCP4XXX is responsible for generating the A bits.

Refer to Figure 7-8 for the Decrement Command sequence. The sequence is terminated by the Stop condition. So when executing a continuous command string, the Increment command can be followed by any other valid command. This means that writes do not need to be to the same volatile memory address.

**Note:** The command sequence can go from an increment to any other valid command for the specified address. Issuing an increment or decrement to a nonvolatile location will cause an error condition (A will be generated).

The advantage of using an Decrement Command instead of a read-modify-write series of commands is speed and simplicity. The wiper will transition after each Command Acknowledge when accessing the volatile wiper registers.

**TABLE 7-5: DECREMENT OPERATION VS. VOLATILE WIPER VALUE**

Current Wiper Setting		Wiper (W) Properties	Decrement Command Operates?
7-bit Pot	8-bit Pot		
3FFh 081h	3FFh 101h	Reserved (Full-Scale (W = A))	No
080h	100h	Full-Scale (W = A)	Yes
07Fh 041h	0FFh 081	W = N	Yes
040h	080h	W = N (Mid-Scale)	
03Fh 001h	07Fh 001	W = N	
000h	000h	Zero Scale (W = B)	No

### 7.7.1 THE HIGH VOLTAGE COMMAND (HVC) SIGNAL

The High Voltage Command (HVC) signal is multiplexed with Address 0 (A0) and is used to indicate that the command, or sequence of commands, are in the High Voltage mode. Signals > V<sub>IHH</sub> (~8.5V) on the HVC/A0 pin puts MCP45XX/46XX devices into High Voltage mode. High Voltage commands allow the device's WiperLock Technology and write protect features to be enabled and disabled.

**Note:** There is a required delay after the HVC pin is driven to the V<sub>IHH</sub> level to the 1st edge of the SCL pin.

The HVC pin has an internal resistor connection to the MCP45XX/46XXs internal V<sub>DD</sub> signal.



**FIGURE 7-8:** I<sup>2</sup>C Decrement Command Sequence.



# MCP454X/456X/464X/466X

## 7.8 Modify Write Protect or WiperLock Technology (High Voltage) Enable and Disable

These commands are special cases of the High Voltage **Decrement Wiper** and the High Voltage **Increment Wiper** commands to the nonvolatile memory locations 02h, 03h, and 0Fh. This command is used to enable or disable either the software Write Protect, wiper 0 WiperLock Technology, or wiper 1 WiperLock Technology. Table 7-6 shows the memory addresses, the High Voltage command and the result of those commands on the nonvolatile WP, WL0, or WL1 bits.

### 7.8.1 SINGLE MODIFY (ENABLE OR DISABLE) WRITE PROTECT OR WIPERLOCK TECHNOLOGY (HIGH VOLTAGE)

Figure 7-9 (Disable) and Figure 7-10 (Enable) show the formats for a single Modify Write Protect or WiperLock Technology command.

A Modify Write Protect or WiperLock Technology Command will only start an EEPROM write cycle ( $t_{wc}$ ) after a properly formatted Command has been received and the Stop condition occurs.

During an EEPROM write cycle, only serial commands to Volatile memory (addresses 00h, 01h, 04h, and 05h) are accepted. All other serial commands are ignored until the EEPROM write cycle ( $t_{wc}$ ) completes. This allows the Host Controller to operate on the Volatile Wiper registers and the TCON register, and to Read the Status Register. The EEWA bit in the Status register indicates the status of an EEPROM Write Cycle.

**TABLE 7-6: ADDRESS MAP TO MODIFY WRITE PROTECT AND WIPERLOCK TECHNOLOGY**

Memory Address	Commands and Result	
	High Voltage <b>Decrement Wiper</b>	High Voltage <b>Increment Wiper</b>
00h	Wiper 0 register is incremented	Wiper 0 register is incremented
01h	Wiper 1 register is decremented	Wiper 1 register is incremented
02h	WL0 is enabled	WL0 is disabled
03h	WL1 is enabled	WL1 is disabled
04h <sup>(1)</sup>	TCON register not changed	TCON register not changed
05h - 0Eh <sup>(1)</sup>	Reserved	Reserved
0Fh	WP is enabled	WP is disabled

**Note 1: Reserved addresses:** Increment or Decrement commands are invalid for these addresses.



**FIGURE 7-9:** I<sup>2</sup>C Disable Command Sequence.



**FIGURE 7-10:** I<sup>2</sup>C Enable Command Sequence.

# MCP454X/456X/464X/466X

---

NOTES:

## 8.0 APPLICATIONS EXAMPLES

Nonvolatile digital potentiometers have a multitude of practical uses in modern electronic circuits. The most popular uses include precision calibration of set point thresholds, sensor trimming, LCD bias trimming, audio attenuation, adjustable power supplies, motor control overcurrent trip setting, adjustable gain amplifiers and offset trimming. The MCP454X/456X/464X/466X devices can be used to replace the common mechanical trim pot in applications where the operating and terminal voltages are within CMOS process limitations ( $V_{DD} = 2.7V$  to  $5.5V$ ).

### 8.1 Using Shutdown

Figure 8-1 shows a possible application circuit where the independent terminals could be used. Disconnecting the wiper allows the transistor input to be taken to the Bias voltage level (disconnecting A and or B may be desired to reduce system current). Disconnecting Terminal A modifies the transistor input by the  $R_{BW}$  rheostat value to the Common B. Disconnecting Terminal B modifies the transistor input by the  $R_{AW}$  rheostat value to the Common A. The Common A and Common B connections could be connected to  $V_{DD}$  and  $V_{SS}$ .



**FIGURE 8-1:** Example Application Circuit using Terminal Disconnects.

### 8.2 Software Reset Sequence

**Note:** This technique is documented in AN1028.

At times it may become necessary to perform a Software Reset Sequence to ensure the MCP45XX/46XX device is in a correct and known I<sup>2</sup>C Interface state. This technique only resets the I<sup>2</sup>C state machine.

This is useful if the MCP45XX/46XX device powers up in an incorrect state (due to excessive bus noise, ...), or if the Master Device is reset during communication. Figure 8-2 shows the communication sequence to software reset the device.



**FIGURE 8-2:** Software Reset Sequence Format.

The 1st Start bit will cause the device to reset from a state in which it is expecting to receive data from the Master Device. In this mode, the device is monitoring the data bus in Receive mode and can detect the Start bit forces an internal Reset.

The nine bits of '1' are used to force a Reset of those devices that could not be reset by the previous Start bit. This occurs only if the MCP45XX/46XX is driving an A bit on the I<sup>2</sup>C bus, or is in output mode (from a Read command) and is driving a data bit of '0' onto the I<sup>2</sup>C bus. In both of these cases, the previous Start bit could not be generated due to the MCP45XX/46XX holding the bus low. By sending out nine '1' bits, it is ensured that the device will see a  $\bar{A}$  bit (the Master Device does not drive the I<sup>2</sup>C bus low to acknowledge the data sent by the MCP45XX/46XX), which also forces the MCP45XX/46XX to reset.

The 2nd Start bit is sent to address the rare possibility of an erroneous write. This could occur if the Master Device was reset while sending a Write command to the MCP45XX/46XX, AND then as the Master Device returns to normal operation and issues a Start condition while the MCP45XX/46XX is issuing an Acknowledge. In this case, if the 2nd Start bit is not sent (and the Stop bit was sent) the MCP45XX/46XX could initiate a write cycle.

**Note:** The potential for this erroneous write ONLY occurs if the Master Device is reset while sending a Write command to the MCP45XX/46XX.

The Stop bit terminates the current I<sup>2</sup>C bus activity. The MCP45XX/46XX wait to detect the next Start condition. This sequence does not effect any other I<sup>2</sup>C devices which may be on the bus, as they should disregard this as an invalid command.

# MCP454X/456X/464X/466X

## 8.3 Using the General Call Command

The use of the General Call Address Increment, Decrement, or Write commands is analogous to the “Load” feature (LDAC pin) on some DACs (such as the MCP4921). This allows all the devices to “Update” the output level “at the same time”.

For some applications, the ability to update the wiper values “at the same time” may be a requirement, since the delay from writing to one wiper value and then the next may cause application issues. A possible example would be a “tuned” circuit that uses several MCP45XX/46XX in rheostat configuration. As the system condition changes (temperature, load, ...) these devices need to be changed (incremented/decremented) to adjust for the system change. These changes will either be in the same direction or in opposite directions. With the Potentiometer device, the customer can either select the PxB terminals (same direction) or the PxA terminal(s) (opposite direction).

Figure 8-4 shows that the update of six devices takes  $6 \cdot T_{I2CDLY}$  time in “normal” operation, but only  $1 \cdot T_{I2CDLY}$  time in “General Call” operation.

**Note:** The application system may need to partition the I<sup>2</sup>C bus into multiple busses to ensure that the MCP45XX/46XX General Call commands do not conflict with the General Call commands that the other I<sup>2</sup>C devices may have defined. Also, if only a portion of the MCP45XX/46XX devices are to require this synchronous operation, then the devices that should not receive these commands should be on the second I<sup>2</sup>C bus.

Figure 8-3 shows two I<sup>2</sup>C bus configurations. In many cases, the single I<sup>2</sup>C bus configuration will be adequate. For applications that do not want all the MCP45XX/46XX devices to do General Call support, or have a conflict with General Call commands, the multiple I<sup>2</sup>C bus configuration would be used.



**FIGURE 8-3:** Typical Application I<sup>2</sup>C Bus Configurations.



**FIGURE 8-4:** Example Comparison of “Normal Operation” vs. “General Call Operation” wiper Updates.

## 8.4 Implementing Log Steps with a Linear Digital Potentiometer

In audio volume control applications, the use of logarithmic steps is desirable, since the human ear hears in a logarithmic manner. The use of a linear potentiometer can approximate a log potentiometer, but with fewer steps. An 8-bit potentiometer can achieve fourteen 3 dB log steps plus a 100% (0 dB) and a mute setting.

Figure 8-5 shows a block diagram of one of the MCP45x1 resistor networks being used to attenuate an input signal. In this case, the attenuation will be ground referenced. Terminal B can be connected to a common mode voltage, but the voltages on the A, B and Wiper terminals must not exceed the MCP45x1's  $V_{DD}/V_{SS}$  voltage limits.



**FIGURE 8-5:** Signal Attenuation Block Diagram - Ground Referenced.

Equation 8-1 shows the equation to calculate voltage dB gain ratios for the digital potentiometer, while Equation 8-2 shows the equation to calculate resistance dB gain ratios. These two equations assume that the B terminal is connected to ground.

If terminal B is not directly resistively connected to ground, then this terminal B to ground resistance ( $R_{B2GND}$ ) must be included into the calculation. Equation 8-3 shows this equation.

### EQUATION 8-1: dB CALCULATIONS (VOLTAGE)

$$L = 20 * \log_{10} (V_{OUT} / V_{IN})$$

dB	$V_{OUT} / V_{IN}$ Ratio
-3	0.70795
-2	0.79433
-1	0.89125

### EQUATION 8-2: dB CALCULATIONS (RESISTANCE) - CASE 1

Terminal B connected to Ground (see Figure 8-5)

$$L = 20 * \log_{10} (R_{BW} / R_{AB})$$

### EQUATION 8-3: dB CALCULATIONS (RESISTANCE) - CASE 2

Terminal B through  $R_{B2GND}$  to Ground

$$L = 20 * \log_{10} ( (R_{BW} + R_{B2GND}) / (R_{AB} + R_{B2GND}) )$$

Table 8-1 shows the codes that can be used for 8-bit digital potentiometers to implement the log attenuation. The table shows the wiper codes for -3 dB, -2 dB, and -1 dB attenuation steps. This table also shows the calculated attenuation based on the wiper code's linear step. Calculated attenuation values less than the desired attenuation are shown with red text. At lower wiper code values, the attenuation may skip a step, if this occurs the next attenuation value is colored magenta to highlight that a skip occurred. For example, in the -3 dB column the -48 dB value is highlighted since the -45 dB step could not be implemented (there are no wiper codes between 2 and 1).

# MCP454X/456X/464X/466X

**TABLE 8-1: LINEAR TO LOG ATTENUATION FOR 8-BIT DIGITAL POTENTIOMETERS**

# of Steps	-3 dB Steps			-2 dB Steps			-1 dB Steps		
	Desired Attenuation	Wiper Code	Calculated Attenuation (1)	Desired Attenuation	Wiper Code	Calculated Attenuation (1)	Desired Attenuation	Wiper Code	Calculated Attenuation (1)
0	0 dB	256	0 dB	0 dB	256	0 dB	0 dB	256	0 dB
1	-3 dB	181	-3.011 dB	-2 dB	203	-2.015 dB	-1 dB	228	-1.006 dB
2	-6 dB	128	-6.021 dB	-4 dB	162	-3.975 dB	-2 dB	203	-2.015 dB
3	-9dB	91	-8.984 dB	-6 dB	128	-6.021 dB	-3 dB	181	-3.011 dB
4	-12 dB	64	-12.041 dB	-8 dB	102	-7.993 dB	-4 dB	162	-3.975 dB
5	-15 dB	46	-14.910 dB	-10 dB	81	-9.995 dB	-5 dB	144	-4.998 dB
6	-18 dB	32	-18.062 dB	-12 dB	64	-12.041 dB	-6 dB	128	-6.021 dB
7	-21 dB	23	-20.930 dB	-14 dB	51	-14.013 dB	-7 dB	114	-7.027 dB
8	-24 dB	16	-24.082 dB	-16 dB	41	-15.909 dB	-8 dB	102	-7.993 dB
9	-27 dB	11	-27.337 dB	-18 dB	32	-18.062 dB	-9 dB	91	-8.984 dB
10	-30 dB	8	-30.103 dB	-20 dB	26	-19.865 dB	-10 dB	81	-9.995 dB
11	-33 dB	6	-32.602 dB	-22 dB	20	-22.144 dB	-11 dB	72	-11.018 dB
12	-36 dB	4	-36.124 dB	-24 dB	16	-24.082 dB	-12 dB	64	-12.041 dB
13	-39 dB	3	-38.622 dB	-26 dB	13	-25.886 dB	-13 dB	57	-13.047 dB
14	-42 dB	2	-42.144 dB	-28 dB	10	-28.165 dB	-14 dB	51	-14.013 dB
15	-48 dB	1	-48.165 dB	-30 dB	8	-30.103 dB	-15 dB	46	-14.910 dB
16	Mute	0	Mute	-32 dB	6	-32.602 dB	-16 dB	41	-15.909 dB
17				-34 dB	5	-34.185 dB	-17 dB	36	-17.039 dB
18				-36 dB	4	-36.124 dB	-18 dB	32	-18.062 dB
19				-38 dB	3	-38.622 dB	-19 dB	29	-18.917 dB
20				-42 dB	2	-42.144 dB	-20 dB	26	-19.865 dB
21				-48 dB	1	-48.165 dB	-21 dB	23	-20.930 dB
22				Mute	0	Mute	-22 dB	20	-22.144 dB
23							-23 dB	18	-23.059 dB
24							-24 dB	16	-24.082 dB
25							-25 dB	14	-25.242 dB
26							-26 dB	13	-25.886 dB
27							-27dB	11	-27.337 dB
28							-28 dB	10	-28.165 dB
29							-29 dB	9	-29.080 dB
30							-30 dB	8	-30.103 dB
31							-31 dB	7	-31.263 dB
32							-33 dB	6	-32.602 dB
33							-34 dB	5	-34.185 dB
34							-36 dB	4	-36.124 dB
35							-39 dB	3	-38.622 dB
36							-42 dB	2	-42.144 dB
37							-48 dB	1	-48.165 dB
38							Mute	0	Mute

**Note 1:** Attenuation values do not include errors from Digital Potentiometer errors, such as Full Scale Error or Zero Scale Error.

# MCP454X/456X/464X/466X

## 8.5 Design Considerations

In the design of a system with the MCP4XXX devices, the following considerations should be taken into account:

- **Power Supply Considerations**
- **Layout Considerations**

### 8.5.1 POWER SUPPLY CONSIDERATIONS

The typical application will require a bypass capacitor in order to filter high-frequency noise, which can be induced onto the power supply's traces. The bypass capacitor helps to minimize the effect of these noise sources on signal integrity. Figure 8-6 illustrates an appropriate bypass strategy.

In this example, the recommended bypass capacitor value is 0.1  $\mu\text{F}$ . This capacitor should be placed as close (within 4 mm) to the device power pin ( $V_{\text{DD}}$ ) as possible.

The power source supplying these devices should be as clean as possible. If the application circuit has separate digital and analog power supplies,  $V_{\text{DD}}$  and  $V_{\text{SS}}$  should reside on the analog plane.



**FIGURE 8-6:** Typical Microcontroller Connections.

### 8.5.2 LAYOUT CONSIDERATIONS

Several layout considerations may be applicable to your application. These may include:

- **Noise**
- **Footprint Compatibility**
- **PCB Area Requirements**

#### 8.5.2.1 Noise

Inductively-coupled AC transients and digital switching noise can degrade the input and output signal integrity, potentially masking the MCP4XXX's performance. Careful board layout minimizes these effects and increases the Signal-to-Noise Ratio (SNR). Multi-layer boards utilizing a low-inductance ground plane, isolated inputs, isolated outputs and proper decoupling are critical to achieving the performance that the silicon is capable of providing. Particularly harsh environments may require shielding of critical signals.

If low noise is desired, breadboards and wire-wrapped boards are not recommended.

#### 8.5.2.2 Footprint Compatibility

The specification of the MCP4XXX pinouts was done to allow systems to be designed to easily support the use of either the dual (MCP46XX) or quad (MCP44XX) device.

Figure 8-7 shows how the dual pinout devices fit on the quad device footprint. For the Rheostat devices, the dual device is in the MSOP package, so the footprints would need to be offset from each other.



**FIGURE 8-7:** Quad Pinout (TSSOP Package) vs. Dual Pinout.

# MCP454X/456X/464X/466X

Figure 8-8 shows possible layout implementations for an application to support the quad and dual options on the same PCB.



**FIGURE 8-8:** Layout to Support Quad and Dual Devices.

## 8.5.2.3 PCB Area Requirements

In some applications, PCB area is a criteria for device selection. Table 8-2 shows the package dimensions and area for the different package options. The table also shows the relative area factor compared to the smallest area. For space critical applications, the QFN package would be the suggested package.

**TABLE 8-2: PACKAGE FOOTPRINT (1)**

Pins	Package		Package Footprint			
	Type	Code	Dimensions (mm)		Area (mm <sup>2</sup> )	Relative Area
			X	Y		
8	MSOP	MS	3.00	4.90	14.70	1.63
	DFN (3x3)	MF	3.00	3.00	9.00	1
10	MSOP	UN	3.00	4.90	14.70	1.63
	DFN (3x3)	MF	3.00	3.00	9.00	1
14	TSSOP	ST	5.10	6.40	32.64	3.62
	QFN (4x4)	ML	4.00	4.00	16.00	1.78
16	TSSOP <sup>(2)</sup>	ST	6.60	6.40	42.24	3.63
	QFN (4x4) <sup>(2)</sup>	ML	4.00	4.00	16.00	1.78

**Note 1:** Does not include recommended land pattern dimensions.

**2:** These packages are for the Quad output devices (MCP44x1).

## 8.5.3 RESISTOR TEMP CO

Characterization curves of the resistor temperature coefficient (Tempco) are shown in Figure 2-10, Figure 2-21, Figure 2-32, and Figure 2-43.

These curves show that the resistor network is designed to correct for the change in resistance as temperature increases. This technique reduces the end-to-end change in  $R_{AB}$  resistance.

## 8.5.4 HIGH VOLTAGE TOLERANT PINS

High Voltage support ( $V_{IHH}$ ) on the Serial Interface pins supports user configuration of the Nonvolatile EEPROM, Write Protect, and WiperLock feature.

**Note:** In many applications, the High Voltage will only be present at the manufacturing stage so as to "lock" the Nonvolatile wiper value (after calibration) and the contents of the EEPROM. This ensures that since High Voltage is not present under normal operating conditions, that these values can not be modified.



## 9.0 DEVICE OPTIONS

Additional, custom devices are available. These devices have weak pull-up resistors on the SDA and SCL pins. This is useful for applications where the wiper value is programmed during manufacture and not modified by the system during normal operation.

Please contact your local sales office for current information and minimum volume requirements.

### 9.1 Custom Options

The custom device will have a "P" (for Pull-up) after the resistance version in the Product Identification System. These devices will not be available through Microchip's online Microchip Direct nor Microchip's Sample systems.

Example part number:

MCP4641-103PE/ST

# MCP454X/456X/464X/466X

---

NOTES:

# MCP454X/456X/464X/466X

## 10.0 DEVELOPMENT SUPPORT

### 10.1 Development Tools

Several development tools are available to assist in your design and evaluation of the MCP45XX/46XX devices. The currently available tools are shown in [Table 10-1](#).

These boards may be purchased directly from the Microchip web site at [www.microchip.com](http://www.microchip.com).

**TABLE 10-1: DEVELOPMENT TOOLS**

Board Name	Part #	Supported Devices
MCP46XX PICTail Plus Daughter Board <sup>(2)</sup>	MCP46XXDM-PTPLS	MCP46XX
MCP46XX Evaluation Board	MCP46XXEV	MCP4631/41/51/61
MCP43XX Evaluation Board	MCP43XXEV	MCP4331/41/51/61
MCP4XXX Digital Potentiometer Daughter Board <sup>(1)</sup>	MCP4XXXDM-DB	MCP42XXX, MCP42XX, MCP46XX, MCP4021, and MCP4011
8-pin SOIC/MSOP/TSSOP/DIP Evaluation Board	SOIC8EV	Any 8-pin device in DIP, SOIC, MSOP, or TSSOP package
14-pin SOIC/MSOP/DIP Evaluation Board	SOIC14EV	Any 14-pin device in DIP, SOIC, or MSOP package

**Note 1:** Requires the use of a PICDEM Demo Board (see User's Guide for details)

**2:** Requires the use of the PIC24 Explorer 16 Demo Board (see User's Guide for details)

**3:** The desired MCP46XX device (in MSOP package) must be soldered onto the extra board.

**TABLE 10-2: TECHNICAL DOCUMENTATION**

Application Note Number	Title	Literature #
TB3073	Implementing a 10-bit Digital Potentiometer using a Quad 8-bit Digital Potentiometer Technical Brief	DS93073
AN1316	Using Digital Potentiometers for Programmable Amplifier Gain	DS01316
AN1080	Understanding Digital Potentiometers Resistor Variations	DS01080
AN737	Using Digital Potentiometers to Design Low Pass Adjustable Filters	DS00737
AN692	Using a Digital Potentiometer to Optimize a Precision Single-Supply Photo Detect	DS00692
AN691	Optimizing the Digital Potentiometer in Precision Circuits	DS00691
AN219	Comparing Digital Potentiometers to Mechanical Potentiometers	DS00219
—	Digital Potentiometer Design Guide	DS22017
—	Signal Chain Design Guide	DS21825

# MCP454X/456X/464X/466X

---

NOTES:

# MCP454X/456X/464X/466X

## 11.0 PACKAGING INFORMATION

### 11.1 Package Marking Information

8-Lead DFN (3x3)



Part Number	Code	Part Number	Code
MCP4541-502E/MF	DACJ	MCP4542-502E/MF	DACP
MCP4541-103E/MF	DACK	MCP4542-103E/MF	DACQ
MCP4541-104E/MF	DACM	MCP4542-104E/MF	DACS
MCP4541-503E/MF	DACL	MCP4542-503E/MF	DACR
MCP4561-502E/MF	DADB	MCP4562-502E/MF	DADF
MCP4561-103E/MF	DADC	MCP4562-103E/MF	DADG
MCP4561-104E/MF	DADE	MCP4562-104E/MF	DADJ
MCP4561-503E/MF	DADD	MCP4562-503E/MF	DADH

Example:



8-Lead MSOP



Part Number	Code	Part Number	Code
MCP4541-103E/MS	454113	MCP4542-103E/MS	454213
MCP4541-104E/MS	454114	MCP4542-104E/MS	454214
MCP4541-502E/MS	454152	MCP4542-502E/MS	454252
MCP4541-503E/MS	454153	MCP4542-503E/MS	454253
MCP4561-103E/MS	456113	MCP4562-103E/MS	456213
MCP4561-104E/MS	456114	MCP4562-104E/MS	456214
MCP4561-502E/MS	456152	MCP4562-502E/MS	456252
MCP4561-503E/MS	456153	MCP4562-503E/MS	456253

Example



**Legend:** XX...X Customer-specific information  
 Y Year code (last digit of calendar year)  
 YY Year code (last 2 digits of calendar year)  
 WW Week code (week of January 1 is week '01')  
 NNN Alphanumeric traceability code  
 (e3) Pb-free JEDEC designator for Matte Tin (Sn)  
 \* This package is Pb-free. The Pb-free JEDEC designator (e3) can be found on the outer packaging for this package.

**Note:** In the event the full Microchip part number cannot be marked on one line, it will be carried over to the next line, thus limiting the number of available characters for customer-specific information.

# MCP454X/456X/464X/466X

## Package Marking Information (Continued)

10-Lead DFN (3x3)



Part Number	Code	Part Number	Code
MCP4642-502E/MF	AAFA	MCP4662-502E/MF	AAQA
MCP4642-103E/MF	AAGA	MCP4662-103E/MF	AARA
MCP4642-104E/MF	AAJA	MCP4662-104E/MF	AATA
MCP4642-503E/MF	AAHA	MCP4662-503E/MF	AASA

Example:



10-Lead MSOP

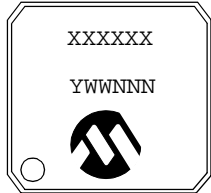

Part Number	Code	Part Number	Code
MCP4642-502E/UN	464252	MCP4662-502E/UN	466252
MCP4642-103E/UN	464213	MCP4662-103E/UN	466213
MCP4642-104E/UN	464214	MCP4662-104E/UN	466214
MCP4642-503E/UN	464253	MCP4662-503E/UN	466253

Example



14-Lead TSSOP (MCP4641, MCP4661)



Example

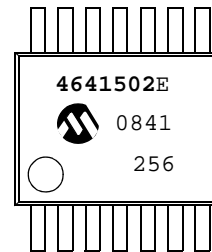

16-Lead QFN (MCP4641, MCP4661)



Example

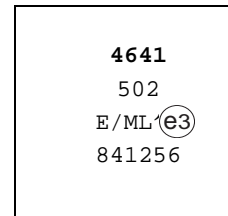

# MCP454X/456X/464X/466X

## 8-Lead Plastic Dual Flat, No Lead Package (MF) - 3x3x0.9mm Body [DFN]

**Note:** For the most current package drawings, please see the Microchip Packaging Specification located at <http://www.microchip.com/packaging>



Microchip Technology Drawing No. C04-062C Sheet 1 of 2

# MCP454X/456X/464X/466X

## 8-Lead Plastic Dual Flat, No Lead Package (MF) - 3x3x0.9mm Body [DFN]

**Note:** For the most current package drawings, please see the Microchip Packaging Specification located at <http://www.microchip.com/packaging>



Dimension Limits	Units	MILLIMETERS		
		MIN	NOM	MAX
Number of Pins	N	8		
Pitch	e	0.65 BSC		
Overall Height	A	0.80	0.90	1.00
Standoff	A1	0.00	0.02	0.05
Contact Thickness	A3	0.20 REF		
Overall Length	D	3.00 BSC		
Exposed Pad Width	E2	1.34	-	1.60
Overall Width	E	3.00 BSC		
Exposed Pad Length	D2	1.60	-	2.40
Contact Width	b	0.25	0.30	0.35
Contact Length	L	0.20	0.30	0.55
Contact-to-Exposed Pad	K	0.20	-	-

**Notes:**

1. Pin 1 visual index feature may vary, but must be located within the hatched area.
2. Package may have one or more exposed tie bars at ends.
3. Package is saw singulated
4. Dimensioning and tolerancing per ASME Y14.5M

BSC: Basic Dimension. Theoretically exact value shown without tolerances.

REF: Reference Dimension, usually without tolerance, for information purposes only.

Microchip Technology Drawing No. C04-062C Sheet 2 of 2



# MCP454X/456X/464X/466X

## 8-Lead Plastic Dual Flat, No Lead Package (MF) – 3x3x0.9 mm Body [DFN]

**Note:** For the most current package drawings, please see the Microchip Packaging Specification located at <http://www.microchip.com/packaging>



RECOMMENDED LAND PATTERN

Dimension Limits	Units	MILLIMETERS		
		MIN	NOM	MAX
Contact Pitch	E	0.65 BSC		
Optional Center Pad Width	W2			2.40
Optional Center Pad Length	T2			1.55
Contact Pad Spacing	C1		3.10	
Contact Pad Width (X8)	X1			0.35
Contact Pad Length (X8)	Y1			0.65
Distance Between Pads	G	0.30		

**Notes:**

1. Dimensioning and tolerancing per ASME Y14.5M

BSC: Basic Dimension. Theoretically exact value shown without tolerances.

Microchip Technology Drawing No. C04-2062A

# MCP454X/456X/464X/466X

## 8-Lead Plastic Micro Small Outline Package (MS) [MSOP]

**Note:** For the most current package drawings, please see the Microchip Packaging Specification located at <http://www.microchip.com/packaging>



Microchip Technology Drawing C04-111C Sheet 1 of 2

# MCP454X/456X/464X/466X

## 8-Lead Plastic Micro Small Outline Package (MS) [MSOP]

**Note:** For the most current package drawings, please see the Microchip Packaging Specification located at <http://www.microchip.com/packaging>



Dimension Limits	Units	MILLIMETERS		
		MIN	NOM	MAX
Number of Pins	N		8	
Pitch	e	0.65 BSC		
Overall Height	A	-	-	1.10
Molded Package Thickness	A2	0.75	0.85	0.95
Standoff	A1	0.00	-	0.15
Overall Width	E	4.90 BSC		
Molded Package Width	E1	3.00 BSC		
Overall Length	D	3.00 BSC		
Foot Length	L	0.40	0.60	0.80
Footprint	L1	0.95 REF		
Foot Angle	φ	0°	-	8°
Lead Thickness	c	0.08	-	0.23
Lead Width	b	0.22	-	0.40

**Notes:**

- Pin 1 visual index feature may vary, but must be located within the hatched area.
- Dimensions D and E1 do not include mold flash or protrusions. Mold flash or protrusions shall not exceed 0.15mm per side.
- Dimensioning and tolerancing per ASME Y14.5M.  
 BSC: Basic Dimension. Theoretically exact value shown without tolerances.  
 REF: Reference Dimension, usually without tolerance, for information purposes only.

Microchip Technology Drawing C04-111C Sheet 2 of 2

# MCP454X/456X/464X/466X

## 8-Lead Plastic Micro Small Outline Package (MS) [MSOP]

**Note:** For the most current package drawings, please see the Microchip Packaging Specification located at <http://www.microchip.com/packaging>



RECOMMENDED LAND PATTERN

Dimension Limits	Units	MILLIMETERS		
		MIN	NOM	MAX
Contact Pitch	E	0.65 BSC		
Contact Pad Spacing	C		4.40	
Overall Width	Z			5.85
Contact Pad Width (X8)	X1			0.45
Contact Pad Length (X8)	Y1			1.45
Distance Between Pads	G1	2.95		
Distance Between Pads	GX	0.20		

**Notes:**

1. Dimensioning and tolerancing per ASME Y14.5M

BSC: Basic Dimension. Theoretically exact value shown without tolerances.

Microchip Technology Drawing No. C04-2111A

# MCP454X/456X/464X/466X

## 10-Lead Plastic Dual Flat, No Lead Package (MF) - 3x3x0.9mm Body [DFN]

**Note:** For the most current package drawings, please see the Microchip Packaging Specification located at <http://www.microchip.com/packaging>



Microchip Technology Drawing No. C04-063C Sheet 1 of 2

# MCP454X/456X/464X/466X

## 10-Lead Plastic Dual Flat, No Lead Package (MF) - 3x3x0.9mm Body [DFN]

**Note:** For the most current package drawings, please see the Microchip Packaging Specification located at <http://www.microchip.com/packaging>



Dimension Limits	Units	MILLIMETERS		
		MIN	NOM	MAX
Number of Pins	N	10		
Pitch	e	0.50 BSC		
Overall Height	A	0.80	0.90	1.00
Standoff	A1	0.00	0.02	0.05
Contact Thickness	A3	0.20 REF		
Overall Length	D	3.00 BSC		
Exposed Pad Length	D2	2.15	2.35	2.45
Overall Width	E	3.00 BSC		
Exposed Pad Width	E2	1.40	1.50	1.75
Contact Width	b	0.18	0.25	0.30
Contact Length	L	0.30	0.40	0.50
Contact-to-Exposed Pad	K	0.20	-	-

### Notes:

1. Pin 1 visual index feature may vary, but must be located within the hatched area.
2. Package may have one or more exposed tie bars at ends.
3. Package is saw singulated.
4. Dimensioning and tolerancing per ASME Y14.5M.  
BSC: Basic Dimension. Theoretically exact value shown without tolerances.  
REF: Reference Dimension, usually without tolerance, for information purposes only.

Microchip Technology Drawing No. C04-063C Sheet 2 of 2

# MCP454X/456X/464X/466X

## 10-Lead Plastic Dual Flat, No Lead Package (MF) - 3x3x0.9mm Body [DFN]

**Note:** For the most current package drawings, please see the Microchip Packaging Specification located at <http://www.microchip.com/packaging>



RECOMMENDED LAND PATTERN

Dimension Limits	Units	MILLIMETERS		
		MIN	NOM	MAX
Contact Pitch	E	0.50 BSC		
Optional Center Pad Width	W2			2.48
Optional Center Pad Length	T2			1.55
Contact Pad Spacing	C1	3.10		
Contact Pad Width (X10)	X1			0.30
Contact Pad Length (X10)	Y1			0.65
Distance Between Pads	G	0.20		

**Notes:**

1. Dimensioning and tolerancing per ASME Y14.5M

BSC: Basic Dimension. Theoretically exact value shown without tolerances.

Microchip Technology Drawing No. C04-2063B

# MCP454X/456X/464X/466X

## 10-Lead Plastic Micro Small Outline Package (UN) [MSOP]

**Note:** For the most current package drawings, please see the Microchip Packaging Specification located at <http://www.microchip.com/packaging>



Microchip Technology Drawing C04-021C Sheet 1 of 2



# MCP454X/456X/464X/466X

## 10-Lead Plastic Micro Small Outline Package (UN) [MSOP]

**Note:** For the most current package drawings, please see the Microchip Packaging Specification located at <http://www.microchip.com/packaging>



Dimension Limits	Units	MILLIMETERS		
		MIN	NOM	MAX
Number of Pins	N	10		
Pitch	e	0.50 BSC		
Overall Height	A	-	-	1.10
Molded Package Thickness	A2	0.75	0.85	0.95
Standoff	A1	0.00	-	0.15
Overall Width	E	4.90 BSC		
Molded Package Width	E1	3.00 BSC		
Overall Length	D	3.00 BSC		
Foot Length	L	0.40	0.60	0.80
Footprint	L1	0.95 REF		
Foot Angle	$\varphi$	0°	-	8°
Lead Thickness	c	0.08	-	0.23
Lead Width	b	0.15	-	0.33

**Notes:**

- Pin 1 visual index feature may vary, but must be located within the hatched area.
- Dimensions D and E1 do not include mold flash or protrusions. Mold flash or protrusions shall not exceed 0.15mm per side.
- Dimensioning and tolerancing per ASME Y14.5M.  
 BSC: Basic Dimension. Theoretically exact value shown without tolerances.  
 REF: Reference Dimension, usually without tolerance, for information purposes only.

Microchip Technology Drawing C04-021C Sheet 2 of 2

# MCP454X/456X/464X/466X

## 10-Lead Plastic Micro Small Outline Package (UN) [MSOP]

**Note:** For the most current package drawings, please see the Microchip Packaging Specification located at <http://www.microchip.com/packaging>



RECOMMENDED LAND PATTERN

Dimension Limits	Units	MILLIMETERS		
		MIN	NOM	MAX
Contact Pitch	E	0.50 BSC		
Contact Pad Spacing	C		4.40	
Overall Width	Z			5.80
Contact Pad Width (X10)	X1			0.30
Contact Pad Length (X10)	Y1			1.40
Distance Between Pads	G1	3.00		
Distance Between Pads	GX	0.20		

Notes:

1. Dimensioning and tolerancing per ASME Y14.5M

BSC: Basic Dimension. Theoretically exact value shown without tolerances.

Microchip Technology Drawing No. C04-2021A

# MCP454X/456X/464X/466X

## 14-Lead Plastic Thin Shrink Small Outline (ST) - 4.4 mm Body [TSSOP]

**Note:** For the most current package drawings, please see the Microchip Packaging Specification located at <http://www.microchip.com/packaging>



Microchip Technology Drawing C04-087C Sheet 1 of 2

# MCP454X/456X/464X/466X

## 14-Lead Plastic Thin Shrink Small Outline (ST) - 4.4 mm Body [TSSOP]

**Note:** For the most current package drawings, please see the Microchip Packaging Specification located at <http://www.microchip.com/packaging>



Dimension Limits	Units	MILLIMETERS		
		MIN	NOM	MAX
Number of Pins	N	14		
Pitch	e	0.65 BSC		
Overall Height	A	-	-	1.20
Molded Package Thickness	A2	0.80	1.00	1.05
Standoff	A1	0.05	-	0.15
Overall Width	E	6.40 BSC		
Molded Package Width	E1	4.30	4.40	4.50
Molded Package Length	D	4.90	5.00	5.10
Foot Length	L	0.45	0.60	0.75
Footprint	(L1)	1.00 REF		
Foot Angle	$\varphi$	0°	-	8°
Lead Thickness	c	0.09	-	0.20
Lead Width	b	0.19	-	0.30

**Notes:**

1. Pin 1 visual index feature may vary, but must be located within the hatched area.
2. Dimensions D and E1 do not include mold flash or protrusions. Mold flash or protrusions shall not exceed 0.15mm per side.
3. Dimensioning and tolerancing per ASME Y14.5M

BSC: Basic Dimension. Theoretically exact value shown without tolerances.

REF: Reference Dimension, usually without tolerance, for information purposes only.

Microchip Technology Drawing No. C04-087C Sheet 2 of 2

# MCP454X/456X/464X/466X

## 14-Lead Plastic Thin Shrink Small Outline (ST) - 4.4 mm Body [TSSOP]

**Note:** For the most current package drawings, please see the Microchip Packaging Specification located at <http://www.microchip.com/packaging>



RECOMMENDED LAND PATTERN

		Units	MILLIMETERS		
Dimension Limits			MIN	NOM	MAX
Contact Pitch	E		0.65 BSC		
Contact Pad Spacing	C1			5.90	
Contact Pad Width (X14)	X1				0.45
Contact Pad Length (X14)	Y1				1.45
Distance Between Pads	G	0.20			

**Notes:**

1. Dimensioning and tolerancing per ASME Y14.5M

BSC: Basic Dimension. Theoretically exact value shown without tolerances.

Microchip Technology Drawing No. C04-2087A

# MCP454X/456X/464X/466X

## 16-Lead Plastic Quad Flat, No Lead Package (ML) – 4x4x0.9 mm Body [QFN]

**Note:** For the most current package drawings, please see the Microchip Packaging Specification located at <http://www.microchip.com/packaging>



Dimension Limits	Units	MILLIMETERS		
		MIN	NOM	MAX
Number of Pins	N	16		
Pitch	e	0.65 BSC		
Overall Height	A	0.80	0.90	1.00
Standoff	A1	0.00	0.02	0.05
Contact Thickness	A3	0.20 REF		
Overall Width	E	4.00 BSC		
Exposed Pad Width	E2	2.50	2.65	2.80
Overall Length	D	4.00 BSC		
Exposed Pad Length	D2	2.50	2.65	2.80
Contact Width	b	0.25	0.30	0.35
Contact Length	L	0.30	0.40	0.50
Contact-to-Exposed Pad	K	0.20	-	-

**Notes:**

- Pin 1 visual index feature may vary, but must be located within the hatched area.
- Package is saw singulated.
- Dimensioning and tolerancing per ASME Y14.5M.

BSC: Basic Dimension. Theoretically exact value shown without tolerances.

REF: Reference Dimension, usually without tolerance, for information purposes only.

Microchip Technology Drawing C04-127B

# MCP454X/456X/464X/466X

## 16-Lead Plastic Quad Flat, No Lead Package (ML) - 4x4x0.9mm Body [QFN]

**Note:** For the most current package drawings, please see the Microchip Packaging Specification located at <http://www.microchip.com/packaging>



RECOMMENDED LAND PATTERN

Dimension Limits	Units	MILLIMETERS		
		MIN	NOM	MAX
Contact Pitch	E	0.65 BSC		
Optional Center Pad Width	W2			2.50
Optional Center Pad Length	T2			2.50
Contact Pad Spacing	C1		4.00	
Contact Pad Spacing	C2		4.00	
Contact Pad Width (X16)	X1			0.35
Contact Pad Length (X16)	Y1			0.80
Distance Between Pads	G	0.30		

**Notes:**

1. Dimensioning and tolerancing per ASME Y14.5M

BSC: Basic Dimension. Theoretically exact value shown without tolerances.

Microchip Technology Drawing No. C04-2127A

# MCP454X/456X/464X/466X

---

NOTES:



## APPENDIX A: REVISION HISTORY

### Revision B (February 2013)

The following is the list of modifications:

1. Updated the DFN package pinout on page 1.
2. Updated the [Absolute Maximum Ratings†](#) page format and added Total Power Dissipation values for each package type.
3. Updated the typical thermal package resistance values for the 8L-DFN (3x3) and 8L-SOIC packages in the [Temperature characteristics](#) table.
4. Added new [Figure 2-59](#) to [Section 2.1 “Test Circuits”](#).
5. Corrected values in [Figure 5-1](#).
6. Added description of wiper value on POR/BOR ([Section 5.2 “Wiper”](#)).
7. Removed Section 8.1.
8. Added [Section 8.4 “Implementing Log Steps with a Linear Digital Potentiometer”](#).
9. Added [Section 8.5.2.2 “Footprint Compatibility”](#).
10. Added [Section 8.5.2.3 “PCB Area Requirements”](#).
11. Updated [Table 8-2](#).
12. Enhanced the listing of development tools and technical documentation in [Section 10.0 “Development support”](#).
13. Updated [Table 10-1](#) and [Table 10-2](#).
14. Updated [Section 11.0 “Packaging Information”](#) with package available landing pattern diagrams.

### Revision A (November 2008)

- Original Release of this Document.

# MCP454X/456X/464X/466X

---

NOTES:

# MCP454X/456X/464X/466X

## PRODUCT IDENTIFICATION SYSTEM

To order or obtain information, e.g., on pricing or delivery, refer to the factory or the listed sales office.

<u>PART NO.</u>	<u>XXX</u>	<u>X</u>	<u>/XX</u>
Device	Resistance Version	Temperature Range	Package
<p><b>Device:</b></p> <p>MCP4541: Single Nonvolatile 7-bit Potentiometer MCP4541T: Single Nonvolatile 7-bit Potentiometer (Tape and Reel)</p> <p>MCP4542: Single Nonvolatile 7-bit Rheostat MCP4542T: Single Nonvolatile 7-bit Rheostat (Tape and Reel)</p> <p>MCP4561: Single Nonvolatile 8-bit Potentiometer MCP4561T: Single Nonvolatile 8-bit Potentiometer (Tape and Reel)</p> <p>MCP4562: Single Nonvolatile 8-bit Rheostat MCP4562T: Single Nonvolatile 8-bit Rheostat (Tape and Reel)</p> <p>MCP4641: Dual Nonvolatile 7-bit Potentiometer MCP4641T: Dual Nonvolatile 7-bit Potentiometer (Tape and Reel)</p> <p>MCP4642: Dual Nonvolatile 7-bit Rheostat MCP4642T: Dual Nonvolatile 7-bit Rheostat (Tape and Reel)</p> <p>MCP4661: Dual Nonvolatile 8-bit Potentiometer MCP4661T: Dual Nonvolatile 8-bit Potentiometer (Tape and Reel)</p> <p>MCP4662: Dual Nonvolatile 8-bit Rheostat MCP4662T: Dual Nonvolatile 8-bit Rheostat (Tape and Reel)</p>			
<p><b>Resistance Version:</b> 502 = 5 kΩ 103 = 10 kΩ 503 = 50 kΩ 104 = 100 kΩ</p>			
<p><b>Temperature Range:</b> E = -40°C to +125°C</p>			
<p><b>Package:</b></p> <p>MF = Plastic Dual Flat No-lead (3x3 DFN), 8/10-lead ML = Plastic Quad Flat No-lead (QFN), 16-lead MS = Plastic Micro Small Outline (MSOP), 8-lead ST = Plastic Thin Shrink Small Outline (TSSOP), 14-lead UN = Plastic Micro Small Outline (MSOP), 10-lead</p>			
<p><b>Examples:</b></p> <p>a) MCP4541-502E/XX: 5 kΩ, 8LD Device b) MCP4541-103E/XX: 10 kΩ, 8-LD Device c) MCP4541-503E/XX: 50 kΩ, 8LD Device d) MCP4541-104E/XX: 100 kΩ, 8LD Device e) MCP4541T-104E/XX: T/R, 100 kΩ, 8LD Device</p> <p>a) MCP4542-502E/XX: 5 kΩ, 8LD Device b) MCP4542-103E/XX: 10 kΩ, 8-LD Device c) MCP4542-503E/XX: 50 kΩ, 8LD Device d) MCP4542-104E/XX: 100 kΩ, 8LD Device e) MCP4542T-104E/XX: T/R, 100 kΩ, 8LD Device</p> <p>a) MCP4561-502E/XX: 5 kΩ, 8LD Device b) MCP4561-103E/XX: 10 kΩ, 8-LD Device c) MCP4561-503E/XX: 50 kΩ, 8LD Device d) MCP4561-104E/XX: 100 kΩ, 8LD Device e) MCP4561T-104E/XX: T/R, 100 kΩ, 8LD Device</p> <p>a) MCP4562-502E/XX: 5 kΩ, 8LD Device b) MCP4562-103E/XX: 10 kΩ, 8-LD Device c) MCP4562-503E/XX: 50 kΩ, 8LD Device d) MCP4562-104E/XX: 100 kΩ, 8LD Device e) MCP4562T-104E/XX: T/R, 100 kΩ, 8LD Device</p> <p>a) MCP4641-502E/XX: 5 kΩ, 8LD Device b) MCP4641-103E/XX: 10 kΩ, 8-LD Device c) MCP4641-503E/XX: 50 kΩ, 8LD Device d) MCP4641-104E/XX: 100 kΩ, 8LD Device e) MCP4641T-104E/XX: T/R, 100 kΩ, 8LD Device</p> <p>a) MCP4642-502E/XX: 5 kΩ, 8LD Device b) MCP4642-103E/XX: 10 kΩ, 8-LD Device c) MCP4642-503E/XX: 50 kΩ, 8LD Device d) MCP4642-104E/XX: 100 kΩ, 8LD Device e) MCP4642T-104E/XX: T/R, 100 kΩ, 8LD Device</p> <p>a) MCP4661-502E/XX: 5 kΩ, 8LD Device b) MCP4661-103E/XX: 10 kΩ, 8-LD Device c) MCP4661-503E/XX: 50 kΩ, 8LD Device d) MCP4661-104E/XX: 100 kΩ, 8LD Device e) MCP4661T-104E/XX: T/R, 100 kΩ, 8LD Device</p> <p>a) MCP4662-502E/XX: 5 kΩ, 8LD Device b) MCP4662-103E/XX: 10 kΩ, 8-LD Device c) MCP4662-503E/XX: 50 kΩ, 8LD Device d) MCP4662-104E/XX: 100 kΩ, 8LD Device e) MCP4662T-104E/XX: T/R, 100 kΩ, 8LD Device</p> <p>XX = MF for 8/10-lead 3x3 DFN = ML for 16-lead QFN = MS for 8-lead MSOP = ST for 14-lead TSSOP = UN for 10-lead MSOP</p>			

# MCP454X/456X/464X/466X

---

NOTES:

---

**Note the following details of the code protection feature on Microchip devices:**

- Microchip products meet the specification contained in their particular Microchip Data Sheet.
- Microchip believes that its family of products is one of the most secure families of its kind on the market today, when used in the intended manner and under normal conditions.
- There are dishonest and possibly illegal methods used to breach the code protection feature. All of these methods, to our knowledge, require using the Microchip products in a manner outside the operating specifications contained in Microchip's Data Sheets. Most likely, the person doing so is engaged in theft of intellectual property.
- Microchip is willing to work with the customer who is concerned about the integrity of their code.
- Neither Microchip nor any other semiconductor manufacturer can guarantee the security of their code. Code protection does not mean that we are guaranteeing the product as “unbreakable.”

Code protection is constantly evolving. We at Microchip are committed to continuously improving the code protection features of our products. Attempts to break Microchip's code protection feature may be a violation of the Digital Millennium Copyright Act. If such acts allow unauthorized access to your software or other copyrighted work, you may have a right to sue for relief under that Act.

---

Information contained in this publication regarding device applications and the like is provided only for your convenience and may be superseded by updates. It is your responsibility to ensure that your application meets with your specifications. MICROCHIP MAKES NO REPRESENTATIONS OR WARRANTIES OF ANY KIND WHETHER EXPRESS OR IMPLIED, WRITTEN OR ORAL, STATUTORY OR OTHERWISE, RELATED TO THE INFORMATION, INCLUDING BUT NOT LIMITED TO ITS CONDITION, QUALITY, PERFORMANCE, MERCHANTABILITY OR FITNESS FOR PURPOSE. Microchip disclaims all liability arising from this information and its use. Use of Microchip devices in life support and/or safety applications is entirely at the buyer's risk, and the buyer agrees to defend, indemnify and hold harmless Microchip from any and all damages, claims, suits, or expenses resulting from such use. No licenses are conveyed, implicitly or otherwise, under any Microchip intellectual property rights.

#### **Trademarks**

The Microchip name and logo, the Microchip logo, dsPIC, FlashFlex, KEELOQ, KEELOQ logo, MPLAB, PIC, PICmicro, PICSTART, PIC<sup>32</sup> logo, rPIC, SST, SST Logo, SuperFlash and UNI/O are registered trademarks of Microchip Technology Incorporated in the U.S.A. and other countries.

FilterLab, Hampshire, HI-TECH C, Linear Active Thermistor, MTP, SEEVAL and The Embedded Control Solutions Company are registered trademarks of Microchip Technology Incorporated in the U.S.A.

Silicon Storage Technology is a registered trademark of Microchip Technology Inc. in other countries.

Analog-for-the-Digital Age, Application Maestro, BodyCom, chipKIT, chipKIT logo, CodeGuard, dsPICDEM, dsPICDEM.net, dsPICworks, dsSPEAK, ECAN, ECONOMONITOR, FanSense, HI-TIDE, In-Circuit Serial Programming, ICSP, Mindi, MiWi, MPASM, MPF, MPLAB Certified logo, MPLIB, MPLINK, mTouch, Omniclient Code Generation, PICC, PICC-18, PICDEM, PICDEM.net, PICkit, PICtail, REAL ICE, rLAB, Select Mode, SQI, Serial Quad I/O, Total Endurance, TSHARC, UniWinDriver, WiperLock, ZENA and Z-Scale are trademarks of Microchip Technology Incorporated in the U.S.A. and other countries.

SQTP is a service mark of Microchip Technology Incorporated in the U.S.A.

GestIC and ULPP are registered trademarks of Microchip Technology Germany II GmbH & Co. & KG, a subsidiary of Microchip Technology Inc., in other countries.

All other trademarks mentioned herein are property of their respective companies.

© 2008-2013, Microchip Technology Incorporated, Printed in the U.S.A., All Rights Reserved.

 Printed on recycled paper.

ISBN: 978-1-62077-032-0

*Microchip received ISO/TS-16949:2009 certification for its worldwide headquarters, design and wafer fabrication facilities in Chandler and Tempe, Arizona; Gresham, Oregon and design centers in California and India. The Company's quality system processes and procedures are for its PIC<sup>®</sup> MCUs and dsPIC<sup>®</sup> DSCs, KEELOQ<sup>®</sup> code hopping devices, Serial EEPROMs, microperipherals, nonvolatile memory and analog products. In addition, Microchip's quality system for the design and manufacture of development systems is ISO 9001:2000 certified.*

---

**QUALITY MANAGEMENT SYSTEM  
CERTIFIED BY DNV  
= ISO/TS 16949 =**



# MICROCHIP

## Worldwide Sales and Service

### AMERICAS

#### Corporate Office

2355 West Chandler Blvd.  
Chandler, AZ 85224-6199  
Tel: 480-792-7200  
Fax: 480-792-7277  
Technical Support:  
<http://www.microchip.com/support>  
Web Address:  
[www.microchip.com](http://www.microchip.com)

#### Atlanta

Duluth, GA  
Tel: 678-957-9614  
Fax: 678-957-1455

#### Boston

Westborough, MA  
Tel: 774-760-0087  
Fax: 774-760-0088

#### Chicago

Itasca, IL  
Tel: 630-285-0071  
Fax: 630-285-0075

#### Cleveland

Independence, OH  
Tel: 216-447-0464  
Fax: 216-447-0643

#### Dallas

Addison, TX  
Tel: 972-818-7423  
Fax: 972-818-2924

#### Detroit

Farmington Hills, MI  
Tel: 248-538-2250  
Fax: 248-538-2260

#### Indianapolis

Noblesville, IN  
Tel: 317-773-8323  
Fax: 317-773-5453

#### Los Angeles

Mission Viejo, CA  
Tel: 949-462-9523  
Fax: 949-462-9608

#### Santa Clara

Santa Clara, CA  
Tel: 408-961-6444  
Fax: 408-961-6445

#### Toronto

Mississauga, Ontario,  
Canada  
Tel: 905-673-0699  
Fax: 905-673-6509

### ASIA/PACIFIC

#### Asia Pacific Office

Suites 3707-14, 37th Floor  
Tower 6, The Gateway  
Harbour City, Kowloon  
Hong Kong  
Tel: 852-2401-1200  
Fax: 852-2401-3431

#### Australia - Sydney

Tel: 61-2-9868-6733  
Fax: 61-2-9868-6755

#### China - Beijing

Tel: 86-10-8569-7000  
Fax: 86-10-8528-2104

#### China - Chengdu

Tel: 86-28-8665-5511  
Fax: 86-28-8665-7889

#### China - Chongqing

Tel: 86-23-8980-9588  
Fax: 86-23-8980-9500

#### China - Hangzhou

Tel: 86-571-2819-3187  
Fax: 86-571-2819-3189

#### China - Hong Kong SAR

Tel: 852-2943-5100  
Fax: 852-2401-3431

#### China - Nanjing

Tel: 86-25-8473-2460  
Fax: 86-25-8473-2470

#### China - Qingdao

Tel: 86-532-8502-7355  
Fax: 86-532-8502-7205

#### China - Shanghai

Tel: 86-21-5407-5533  
Fax: 86-21-5407-5066

#### China - Shenyang

Tel: 86-24-2334-2829  
Fax: 86-24-2334-2393

#### China - Shenzhen

Tel: 86-755-8864-2200  
Fax: 86-755-8203-1760

#### China - Wuhan

Tel: 86-27-5980-5300  
Fax: 86-27-5980-5118

#### China - Xian

Tel: 86-29-8833-7252  
Fax: 86-29-8833-7256

#### China - Xiamen

Tel: 86-592-2388138  
Fax: 86-592-2388130

#### China - Zhuhai

Tel: 86-756-3210040  
Fax: 86-756-3210049

### ASIA/PACIFIC

#### India - Bangalore

Tel: 91-80-3090-4444  
Fax: 91-80-3090-4123

#### India - New Delhi

Tel: 91-11-4160-8631  
Fax: 91-11-4160-8632

#### India - Pune

Tel: 91-20-2566-1512  
Fax: 91-20-2566-1513

#### Japan - Osaka

Tel: 81-6-6152-7160  
Fax: 81-6-6152-9310

#### Japan - Tokyo

Tel: 81-3-6880-3770  
Fax: 81-3-6880-3771

#### Korea - Daegu

Tel: 82-53-744-4301  
Fax: 82-53-744-4302

#### Korea - Seoul

Tel: 82-2-554-7200  
Fax: 82-2-558-5932 or  
82-2-558-5934

#### Malaysia - Kuala Lumpur

Tel: 60-3-6201-9857  
Fax: 60-3-6201-9859

#### Malaysia - Penang

Tel: 60-4-227-8870  
Fax: 60-4-227-4068

#### Philippines - Manila

Tel: 63-2-634-9065  
Fax: 63-2-634-9069

#### Singapore

Tel: 65-6334-8870  
Fax: 65-6334-8850

#### Taiwan - Hsin Chu

Tel: 886-3-5778-366  
Fax: 886-3-5770-955

#### Taiwan - Kaohsiung

Tel: 886-7-213-7828  
Fax: 886-7-330-9305

#### Taiwan - Taipei

Tel: 886-2-2508-8600  
Fax: 886-2-2508-0102

#### Thailand - Bangkok

Tel: 66-2-694-1351  
Fax: 66-2-694-1350

### EUROPE

#### Austria - Wels

Tel: 43-7242-2244-39  
Fax: 43-7242-2244-393

#### Denmark - Copenhagen

Tel: 45-4450-2828  
Fax: 45-4485-2829

#### France - Paris

Tel: 33-1-69-53-63-20  
Fax: 33-1-69-30-90-79

#### Germany - Munich

Tel: 49-89-627-144-0  
Fax: 49-89-627-144-44

#### Italy - Milan

Tel: 39-0331-742611  
Fax: 39-0331-466781

#### Netherlands - Drunen

Tel: 31-416-690399  
Fax: 31-416-690340

#### Spain - Madrid

Tel: 34-91-708-08-90  
Fax: 34-91-708-08-91

#### UK - Wokingham

Tel: 44-118-921-5869  
Fax: 44-118-921-5820

11/29/12

# Mouser Electronics

Authorized Distributor

Click to View Pricing, Inventory, Delivery & Lifecycle Information:

## Microchip:

[MCP4642T-502E/MF](#) [MCP4541-503E/MS](#) [MCP4641T-502E/ML](#) [MCP4662T-503E/UN](#) [MCP4642T-104E/UN](#)  
[MCP4662T-103E/UN](#) [MCP4661T-103E/ML](#) [MCP4642T-502E/UN](#) [MCP4661T-503E/ML](#) [MCP4642T-104E/MF](#)  
[MCP4641T-103E/ST](#) [MCP4641T-503E/ST](#) [MCP4641T-502E/ST](#) [MCP4561-103E/MS](#) [MCP4561-503E/MS](#)  
[MCP4541T-104E/MF](#) [MCP4662T-103E/MF](#) [MCP4542-502E/MS](#) [MCP4662T-503E/MF](#) [MCP4541T-104E/MS](#)  
[MCP4562T-104E/MF](#) [MCP4562-103E/MS](#) [MCP4542T-502E/MS](#) [MCP4661T-103E/ST](#) [MCP4542T-104E/MS](#)  
[MCP4661T-502E/ML](#) [MCP4642-103E/UN](#) [MCP4661-502E/ST](#) [MCP4662T-104E/UN](#) [MCP4562-503E/MS](#) [MCP4642-](#)  
[104E/UN](#) [MCP4642T-503E/MF](#) [MCP4661T-104E/ST](#) [MCP4541T-502E/MF](#) [MCP4542T-104E/MF](#) [MCP4541-104E/MS](#)  
[MCP4641T-503E/ML](#) [MCP4642T-103E/MF](#) [MCP4542-104E/MS](#) [MCP4561-502E/MS](#) [MCP4642-502E/UN](#)  
[MCP4562T-503E/MF](#) [MCP4541-502E/MS](#) [MCP4661-104E/ST](#) [MCP4641T-104E/ST](#) [MCP4662T-502E/MF](#)  
[MCP4662T-502E/UN](#) [MCP4662T-104E/MF](#) [MCP4642-503E/UN](#) [MCP4561T-104E/MF](#) [MCP4562-502E/MS](#)  
[MCP4561T-104E/MS](#) [MCP4562T-104E/MS](#) [MCP4661T-503E/ST](#) [MCP4561T-103E/MS](#) [MCP4641-503E/ST](#)  
[MCP4561T-503E/MS](#) [MCP4542T-502E/MF](#) [MCP4641T-103E/ML](#) [MCP4662-104E/UN](#) [MCP4561-104E/MS](#)  
[MCP4661-503E/ST](#) [MCP4542T-103E/MF](#) [MCP4641-502E/ST](#) [MCP4561T-103E/MF](#) [MCP4561T-503E/MF](#) [MCP4662-](#)  
[503E/UN](#) [MCP4642T-103E/UN](#) [MCP4541T-502E/MS](#) [MCP4562T-103E/MF](#) [MCP4562T-503E/MS](#) [MCP4642T-](#)  
[503E/UN](#) [MCP4641-103E/ST](#) [MCP4562T-103E/MS](#) [MCP4542-103E/MS](#) [MCP4662-103E/UN](#) [MCP4661T-502E/ST](#)  
[MCP4561T-502E/MS](#) [MCP4541T-503E/MS](#) [MCP4661-103E/ST](#) [MCP4541T-103E/MF](#) [MCP4662-502E/UN](#)  
[MCP4562T-502E/MF](#) [MCP4561T-502E/MF](#) [MCP4562T-502E/MS](#) [MCP4641T-104E/ML](#) [MCP4542T-503E/MS](#)  
[MCP4641-104E/ST](#) [MCP4542-503E/MS](#) [MCP4541-103E/MS](#) [MCP4542T-103E/MS](#) [MCP4541T-103E/MS](#)  
[MCP4661T-104E/ML](#) [MCP4542T-503E/MF](#) [MCP4562-104E/MS](#) [MCP4541T-503E/MF](#) [MCP4541T-103E/MSVAO](#)  
[MCP4541T-503E/MSVAO](#)

Компания «Океан Электроники» предлагает заключение долгосрочных отношений при поставках импортных электронных компонентов на взаимовыгодных условиях!

Наши преимущества:

- Поставка оригинальных импортных электронных компонентов напрямую с производств Америки, Европы и Азии, а так же с крупнейших складов мира;
- Широкая линейка поставок активных и пассивных импортных электронных компонентов (более 30 млн. наименований);
- Поставка сложных, дефицитных, либо снятых с производства позиций;
- Оперативные сроки поставки под заказ (от 5 рабочих дней);
- Экспресс доставка в любую точку России;
- Помощь Конструкторского Отдела и консультации квалифицированных инженеров;
- Техническая поддержка проекта, помощь в подборе аналогов, поставка прототипов;
- Поставка электронных компонентов под контролем ВП;
- Система менеджмента качества сертифицирована по Международному стандарту ISO 9001;
- При необходимости вся продукция военного и аэрокосмического назначения проходит испытания и сертификацию в лаборатории (по согласованию с заказчиком);
- Поставка специализированных компонентов военного и аэрокосмического уровня качества (Xilinx, Altera, Analog Devices, Intersil, Interpoint, Microsemi, Actel, Aeroflex, Peregrine, VPT, Syfer, Eurofarad, Texas Instruments, MS Kennedy, Miteq, Cobham, E2V, MA-COM, Hittite, Mini-Circuits, General Dynamics и др.);

Компания «Океан Электроники» является официальным дистрибьютором и эксклюзивным представителем в России одного из крупнейших производителей разъемов военного и аэрокосмического назначения «**JONHON**», а так же официальным дистрибьютором и эксклюзивным представителем в России производителя высокотехнологичных и надежных решений для передачи СВЧ сигналов «**FORSTAR**».



## JONHON

«**JONHON**» (основан в 1970 г.)

Разъемы специального, военного и аэрокосмического назначения:

(Применяются в военной, авиационной, аэрокосмической, морской, железнодорожной, горно- и нефтедобывающей отраслях промышленности)

«**FORSTAR**» (основан в 1998 г.)

ВЧ соединители, коаксиальные кабели, кабельные сборки и микроволновые компоненты:

(Применяются в телекоммуникациях гражданского и специального назначения, в средствах связи, РЛС, а так же военной, авиационной и аэрокосмической отраслях промышленности).



Телефон: 8 (812) 309-75-97 (многоканальный)

Факс: 8 (812) 320-03-32

Электронная почта: [ocean@oceanchips.ru](mailto:ocean@oceanchips.ru)

Web: <http://oceanchips.ru/>

Адрес: 198099, г. Санкт-Петербург, ул. Калинина, д. 2, корп. 4, лит. А