

## USB-OTG BUS-Port ESD-Protection for $V_{BUS} = 28\text{ V}$

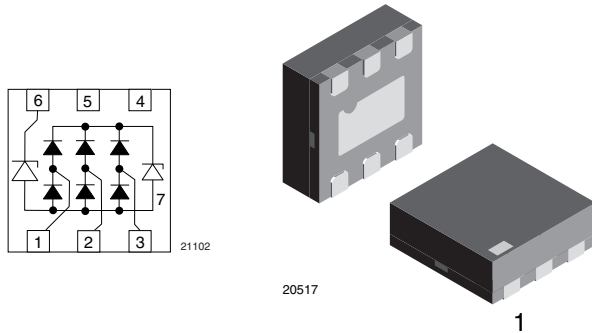

### FEATURES

- Ultra compact LLP75-7L package
- Low package height < 0.6 mm
- 3-line USB ESD-protection with max. working range = 5.5 V
- $V_{BUS}$ -protection with 28 V working range
- Low leakage current
- Low load capacitance  $C_D = 0.7\text{ pF}$
- ESD-protection to IEC 61000-4-2  
± 15 kV contact discharge  
± 15 kV air discharge
- Surge current acc. IEC 61000-4-5  $I_{PP} > 3\text{ A}$
- e4 - precious metal (e.g. Ag, Au, NiPd, NiPdAu) (no Sn)
- Compliant to RoHS Directive 2002/95/EC and in accordance to WEEE 2002/96/EC



### MARKING (example only)

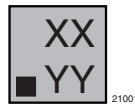

Dot = pin 1 marking  
XX = date code  
YY = type code (see table below)

ORDERING INFORMATION			
DEVICE NAME	ORDERING CODE	TAPED UNITS PER REEL (8 mm TAPE on 7" REEL)	MINIMUM ORDER QUANTITY
VBUS053CZ-HAF	VBUS053CZ-HAF-G-08	3000	15 000

PACKAGE DATA						
DEVICE NAME	PACKAGE NAME	TYPE CODE	WEIGHT	MOLDING COMPOUND FLAMMABILITY RATING	MOISTURE SENSITIVITY LEVEL	SOLDERING CONDITIONS
VBUS053CZ-HAF	LLP75-7L	UA	4.2 mg	UL 94 V-0	MSL level 1 (according J-STD-020)	260 °C/10 s at terminals

ABSOLUTE MAXIMUM RATINGS				
PARAMETER	TEST CONDITIONS	SYMBOL	VALUE	UNIT
<b>Data line D+, D-, ID: Pin 1, 2 and 3 to ground (pin 7)</b>				
Peak pulse current	acc. IEC 61000-4-5; $t_p = 8/20\text{ }\mu\text{s}$ ; single shot	$I_{PPM}$	3	A
Peak pulse power	acc. IEC 61000-4-5; $t_p = 8/20\text{ }\mu\text{s}$ ; single shot	$P_{PP}$	36	W
ESD immunity	Contact discharge acc. IEC 61000-4-2; 10 pulses	$V_{ESD}$	± 15	kV
	Air discharge acc. IEC 61000-4-2; 10 pulses		± 15	kV
<b><math>V_{BUS}</math>: Pin 6 to ground (pin 7)</b>				
Peak pulse current	acc. IEC 61000-4-5; $t_p = 8/20\text{ }\mu\text{s}$ ; single shot	$I_{PPM}$	3	A
Peak pulse power	acc. IEC 61000-4-5; $t_p = 8/20\text{ }\mu\text{s}$ ; single shot	$P_{PP}$	156	W
ESD immunity	Contact discharge acc. IEC 61000-4-2; 10 pulses	$V_{ESD}$	± 30	kV
	Air discharge acc. IEC 61000-4-2; 10 pulses		± 30	kV
Operating temperature	Junction temperature	$T_J$	- 40 to + 125	°C
Storage temperature		$T_{STG}$	- 55 to + 150	°C

\*\* Please see document "Vishay Material Category Policy": [www.vishay.com/doc?99902](http://www.vishay.com/doc?99902)

ELECTRICAL CHARACTERISTICS VBUS053CZ-HAF All inputs (pin 1, 2, and 3) to ground (pin 7)						
PARAMETER	TEST CONDITIONS/REMARKS	SYMBOL	MIN.	TYP.	MAX.	UNIT
Protection paths	Number of line which can be protected	$N_{\text{channel}}$	-	-	3	lines
Reverse working voltage	at $I_R = 0.1\ \mu\text{A}$	$V_{RWM}$	-	-	5.5	V
Reverse current	at $V_R = 3.3\text{ V}$	$I_R$	-	-	0.02	$\mu\text{A}$
	at $V_R = 3.3\text{ V}; T = 65\text{ }^\circ\text{C}$		-	-	0.085	$\mu\text{A}$
	at $V_R = V_{RWM} = 5.5\text{ V}$		-	-	0.1	$\mu\text{A}$
Forward voltage	at $I_F = 15\text{ mA}$	$V_F$	0.7	-	1.2	V
Reverse breakdown voltage	at $I_R = 1\text{ mA}$	$V_{BR}$	6.5	-	10	V
Reverse clamping voltage	at $I_{PP} = 1\text{ A}; \text{acc. IEC 61000-4-5}$	$V_C$	-	10	12	V
	at $I_{PP} = 3\text{ A}; \text{acc. IEC 61000-4-5}$		-	15	18	V
Forward clamping voltage	at $I_F = 3\text{ A}; \text{acc. IEC 61000-4-5}$	$V_F$	-	3.4	4.1	V
Line capacitance	Test pin at $V_R = 0\text{ V};$ any other I/O pin at $V_R = 3.3\text{ V}; f = 1\text{ MHz}$	$C_D$	-	0.7	1	pF
Line to line capacitance	Among pins 1, 2 and 3 at $V_R = 0\text{ V}; f = 1\text{ MHz}$		-	0.35	0.5	pF
Line symmetry	Difference of the line capacitance	$dC_D$	-	-	0.1	pF

**Note**

- Ratings at  $25\text{ }^\circ\text{C}$ , ambient temperature unless otherwise specified

ELECTRICAL CHARACTERISTICS VBUS053CZ-HAF $V_{BUS}$ (pin 6) to ground (pin 7)						
PARAMETER	TEST CONDITIONS/REMARKS	SYMBOL	MIN.	TYP.	MAX.	UNIT
Protection paths	Number of line which can be protected	$N_{\text{channel}}$	-	-	1	lines
Reverse working voltage	at $I_R = 100\text{ nA}$	$V_{RWM}$	-	-	28	V
Reverse current	at $V_R = V_{RWM} = 28\text{ V}$	$I_R$	-	-	100	nA
Forward voltage	at $I_F = 10\text{ mA}$	$V_F$	0.6	0.75	0.9	V
Reverse breakdown voltage	at $I_R = 1\text{ mA}$	$V_{BR}$	32	-	40	V
Reverse clamping voltage	at $I_{PP} = 1\text{ A}; \text{acc. IEC 61000-4-5}; T = 25\text{ }^\circ\text{C}$	$V_C$	-	37	45	V
	at $I_{PP} = 3\text{ A}; \text{acc. IEC 61000-4-5}; T = 25\text{ }^\circ\text{C}$		-	42	52	V
Forward clamping voltage	at $I_F = 3\text{ A}; \text{acc. IEC 61000-4-5}$	$V_F$	-	-	2.2	V
Line capacitance	at $V_R = 0\text{ V}; f = 1\text{ MHz}$	$C_D$	-	31	40	pF

**Note**

- Ratings at  $25\text{ }^\circ\text{C}$ , ambient temperature unless otherwise specified

## APPLICATION NOTE

The VBUS053CZ-HAF is intended as an ESD-protection and transient voltage suppressor for one USB-OTG port. The LLP75-7L package contains two separate dies which are mounted on a common ground plane (pin 7). The high-speed data lines D-, D+ and ID, are connected to any of the pins no. 1 to 3. As long as the signal voltage on the data lines is between the ground- and the 5 V working range, the low capacitance PN-diodes offer a very high isolation to ground and to the other data lines. But as soon as any transient signal like an ESD-signal, exceeds this working range of 5 V in either the positive or negative direction, one of the PN-diodes gets into the forward mode and clamps the transient either to ground or to the avalanche break through level. An extra avalanche diode (separate die) clamps the supply line voltage ( $V_{BUS}$  at pin 6) above the 28 V working range to ground (pin 7). Due to the “two die construction” the  $V_{BUS}$  line has a very high isolation to the data lines. In case of a destructive transient signal, i.e. coming from a charger, the data lines will not be influenced.

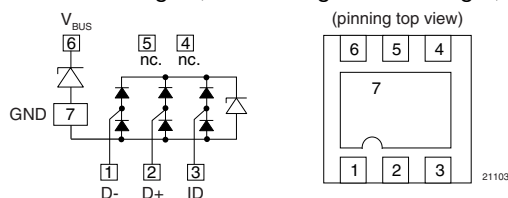

**Remark:**

The input pins no. 1, 2 and 3 are symmetrical. Each of the data signals D-, D+ and ID can be connected to pin 1, 2 or 3.



**TYPICAL CHARACTERISTICS** ( $T_{amb} = 25\text{ }^{\circ}\text{C}$ , unless otherwise specified)

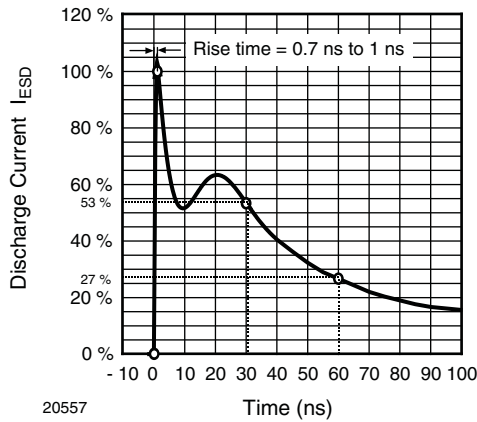

Fig. 1 - ESD Discharge Current Wave Form acc. IEC 61000-4-2 (330  $\Omega$ /150 pF)

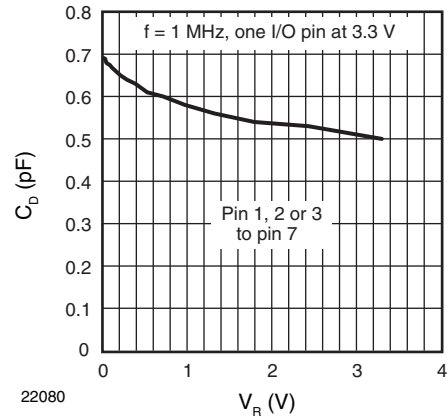

Fig. 4 - Typical Capacitance  $C_D$  vs. Reverse Voltage  $V_R$

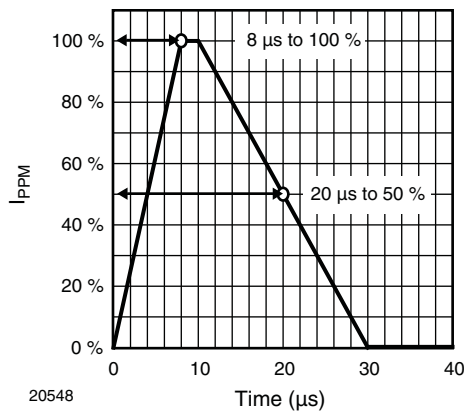

Fig. 2 - 8/20  $\mu\text{s}$  Peak Pulse Current Wave Form acc. IEC 61000-4-5

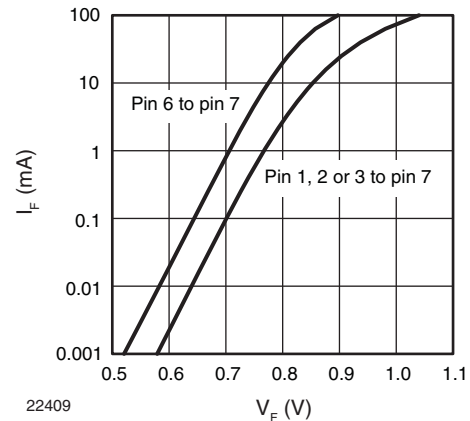

Fig. 5 - Typical Forward Current  $I_F$  vs. Forward Voltage  $V_F$

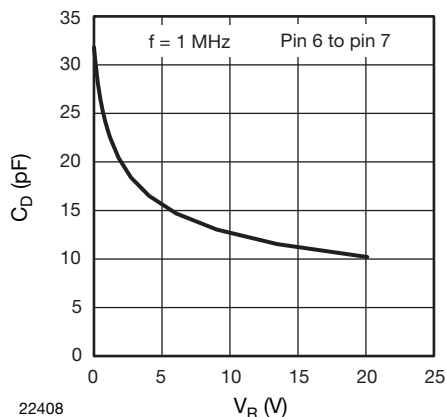

Fig. 3 - Typical Capacitance  $C_D$  vs. Reverse Voltage  $V_R$

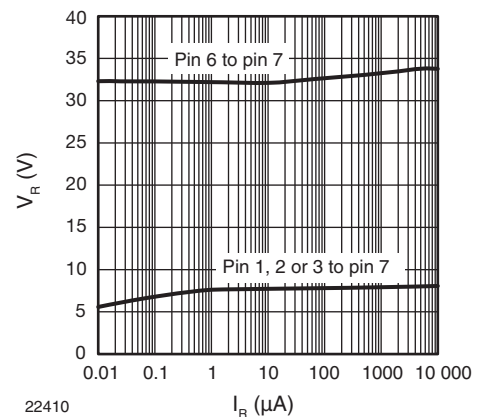

Fig. 6 - Typical Reverse Voltage  $V_R$  vs. Reverse Current  $I_R$

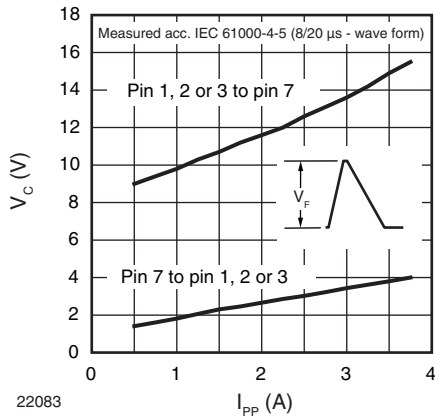

Fig. 7 - Typical Peak Clamping Voltage  $V_C$  vs. Peak Pulse Current  $I_{PP}$

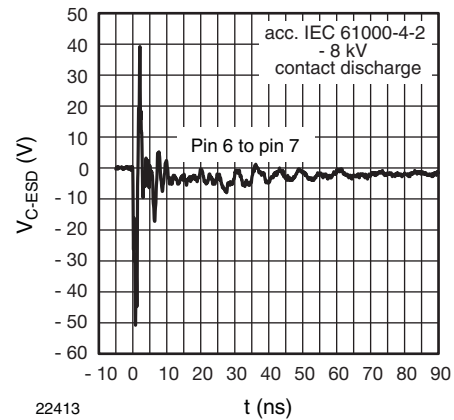

Fig. 10 - Typical Clamping Performance at -8 kV Contact Discharge (acc. IEC 61000-4-2)

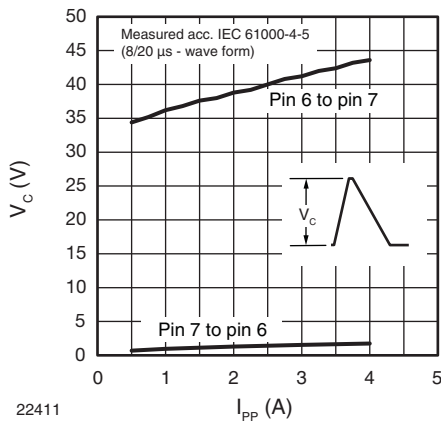

Fig. 8 - Typical Peak Clamping Voltage  $V_C$  vs. Peak Pulse Current  $I_{PP}$

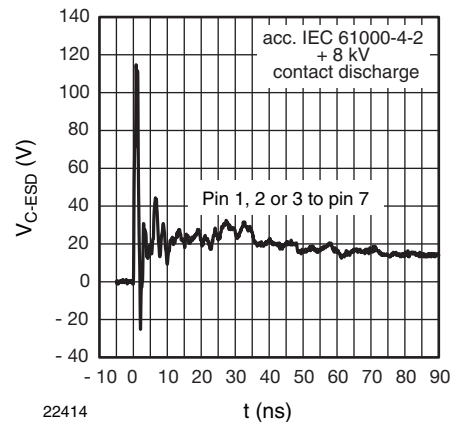

Fig. 11 - Typical Clamping Performance at +8 kV Contact Discharge (acc. IEC 61000-4-2)

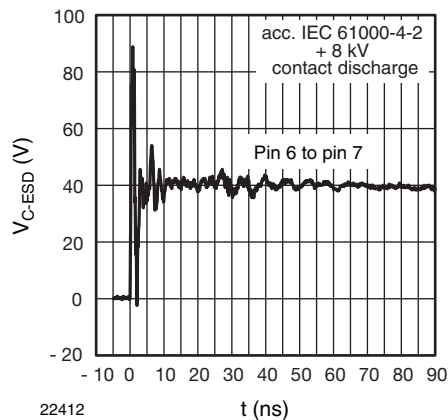

Fig. 9 - Typical Clamping Performance at +8 kV Contact Discharge (acc. IEC 61000-4-2)

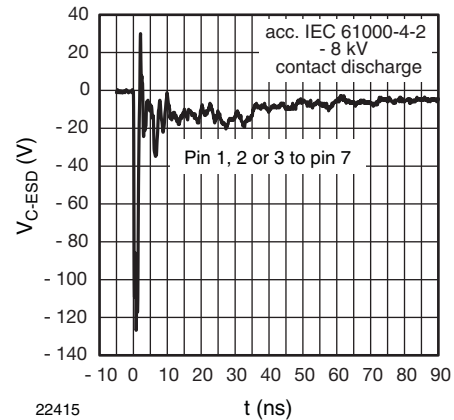

Fig. 12 - Typical Clamping Performance at -8 kV Contact Discharge (acc. IEC 61000-4-2)

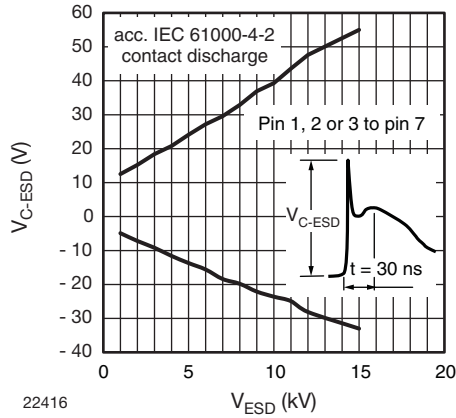

Fig. 13 - Typical Clamping Voltage at after 30 ns of ESD Contact Discharge (acc. IEC 61000-4-2)

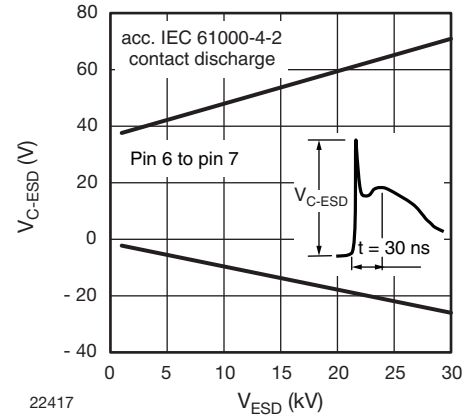
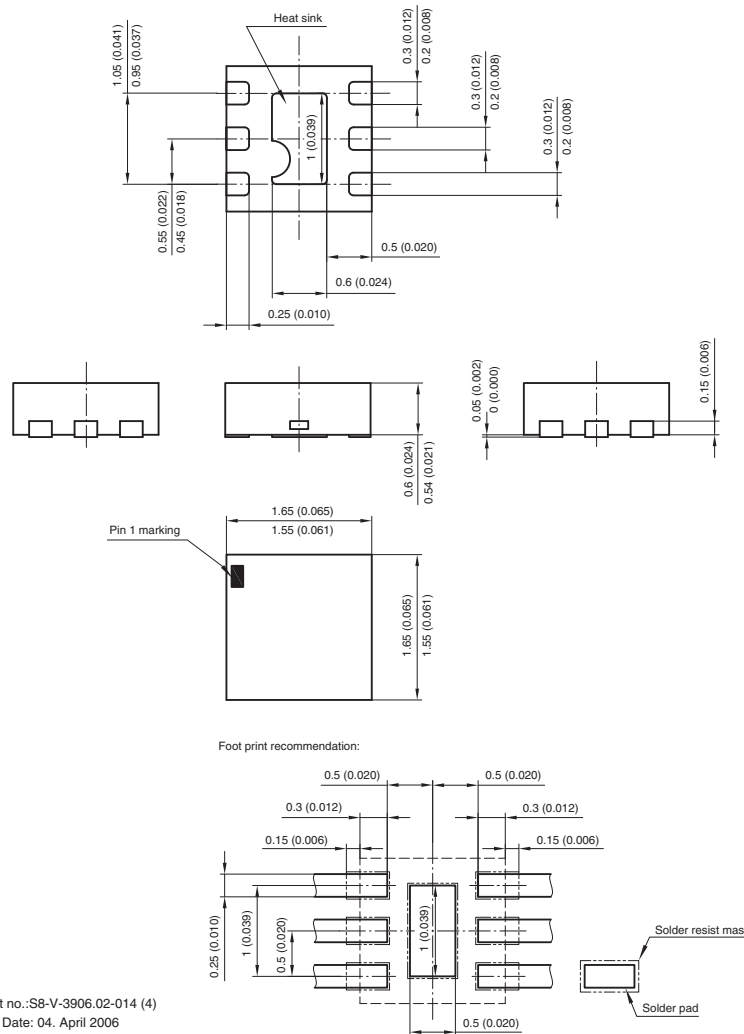

Fig. 14 - Typical Clamping Voltage at after 30 ns of ESD Contact Discharge (acc. IEC 61000-4-2)

**PACKAGE DIMENSIONS** in millimeters (inches): **LLP75-7L**

 Document no.: S8-V-3906.02-014 (4)  
 Created - Date: 04. April 2006  
 20500



## Disclaimer

ALL PRODUCT, PRODUCT SPECIFICATIONS AND DATA ARE SUBJECT TO CHANGE WITHOUT NOTICE TO IMPROVE RELIABILITY, FUNCTION OR DESIGN OR OTHERWISE.

Vishay Intertechnology, Inc., its affiliates, agents, and employees, and all persons acting on its or their behalf (collectively, "Vishay"), disclaim any and all liability for any errors, inaccuracies or incompleteness contained in any datasheet or in any other disclosure relating to any product.

Vishay makes no warranty, representation or guarantee regarding the suitability of the products for any particular purpose or the continuing production of any product. To the maximum extent permitted by applicable law, Vishay disclaims (i) any and all liability arising out of the application or use of any product, (ii) any and all liability, including without limitation special, consequential or incidental damages, and (iii) any and all implied warranties, including warranties of fitness for particular purpose, non-infringement and merchantability.

Statements regarding the suitability of products for certain types of applications are based on Vishay's knowledge of typical requirements that are often placed on Vishay products in generic applications. Such statements are not binding statements about the suitability of products for a particular application. It is the customer's responsibility to validate that a particular product with the properties described in the product specification is suitable for use in a particular application. Parameters provided in datasheets and/or specifications may vary in different applications and performance may vary over time. All operating parameters, including typical parameters, must be validated for each customer application by the customer's technical experts. Product specifications do not expand or otherwise modify Vishay's terms and conditions of purchase, including but not limited to the warranty expressed therein.

Except as expressly indicated in writing, Vishay products are not designed for use in medical, life-saving, or life-sustaining applications or for any other application in which the failure of the Vishay product could result in personal injury or death. Customers using or selling Vishay products not expressly indicated for use in such applications do so at their own risk and agree to fully indemnify and hold Vishay and its distributors harmless from and against any and all claims, liabilities, expenses and damages arising or resulting in connection with such use or sale, including attorneys fees, even if such claim alleges that Vishay or its distributor was negligent regarding the design or manufacture of the part. Please contact authorized Vishay personnel to obtain written terms and conditions regarding products designed for such applications.

No license, express or implied, by estoppel or otherwise, to any intellectual property rights is granted by this document or by any conduct of Vishay. Product names and markings noted herein may be trademarks of their respective owners.

Компания «Океан Электроники» предлагает заключение долгосрочных отношений при поставках импортных электронных компонентов на взаимовыгодных условиях!

Наши преимущества:

- Поставка оригинальных импортных электронных компонентов напрямую с производств Америки, Европы и Азии, а так же с крупнейших складов мира;
- Широкая линейка поставок активных и пассивных импортных электронных компонентов (более 30 млн. наименований);
- Поставка сложных, дефицитных, либо снятых с производства позиций;
- Оперативные сроки поставки под заказ (от 5 рабочих дней);
- Экспресс доставка в любую точку России;
- Помощь Конструкторского Отдела и консультации квалифицированных инженеров;
- Техническая поддержка проекта, помощь в подборе аналогов, поставка прототипов;
- Поставка электронных компонентов под контролем ВП;
- Система менеджмента качества сертифицирована по Международному стандарту ISO 9001;
- При необходимости вся продукция военного и аэрокосмического назначения проходит испытания и сертификацию в лаборатории (по согласованию с заказчиком);
- Поставка специализированных компонентов военного и аэрокосмического уровня качества (Xilinx, Altera, Analog Devices, Intersil, Interpoint, Microsemi, Actel, Aeroflex, Peregrine, VPT, Syfer, Eurofarad, Texas Instruments, MS Kennedy, Miteq, Cobham, E2V, MA-COM, Hittite, Mini-Circuits, General Dynamics и др.);

Компания «Океан Электроники» является официальным дистрибьютором и эксклюзивным представителем в России одного из крупнейших производителей разъемов военного и аэрокосмического назначения «JONHON», а так же официальным дистрибьютором и эксклюзивным представителем в России производителя высокотехнологичных и надежных решений для передачи СВЧ сигналов «FORSTAR».



## JONHON

«JONHON» (основан в 1970 г.)

Разъемы специального, военного и аэрокосмического назначения:

(Применяются в военной, авиационной, аэрокосмической, морской, железнодорожной, горно- и нефтедобывающей отраслях промышленности)

«FORSTAR» (основан в 1998 г.)

ВЧ соединители, коаксиальные кабели, кабельные сборки и микроволновые компоненты:

(Применяются в телекоммуникациях гражданского и специального назначения, в средствах связи, РЛС, а так же военной, авиационной и аэрокосмической отраслях промышленности).



Телефон: 8 (812) 309-75-97 (многоканальный)

Факс: 8 (812) 320-03-32

Электронная почта: [ocean@oceanchips.ru](mailto:ocean@oceanchips.ru)

Web: <http://oceanchips.ru/>

Адрес: 198099, г. Санкт-Петербург, ул. Калинина, д. 2, корп. 4, лит. А