

Operational Amplifiers Series

High Speed with High Voltage Operational Amplifiers



BA3472xxx, BA3472RFVM, BA3474xxx, BA3474RFV

● **General Description**

BA3472,BA3472R,BA3474,BA3474R are dual and quad high slew rate amplifier with wide operating voltage range +3V to +36V(single supply). Especially, there characteristics are high slew rate (10V/μs) and wide gain band width (4MHz).

● **Features**

- Operable with a single power supply
- Wide operating supply voltage
- Internal phase compensation
- High open loop voltage gain
- Internal ESD protection circuit
- Operable low input voltage around GND level
- Wide output voltage range

● **Application**

- Current sense application
- Buffer application amplifier
- Active filter
- Consumer electronics

● **Packages**

Packages	W(Typ.) x D(Typ.) x H(Max.)
SOP8	5.00mm x 6.20mm x 1.71mm
SOP-J8	4.90mm x 6.00mm x 1.65mm
SSOP-B8	3.00mm x 6.40mm x 1.35mm
TSSOP-B8	3.00mm x 6.40mm x 1.20mm
MSOP8	2.90mm x 4.00mm x 0.90mm
SOP14	8.70mm x 6.20mm x 1.71mm
SSOP-B14	5.00mm x 6.40mm x 1.35mm
TSSOP-B14J	5.00mm x 6.40mm x 1.20mm

● **Key Specifications**

- Wide Operating Supply Voltage:
 - Single supply +3.0V to +36.0V
 - Dual supply ±1.5V to ±18.0V
- Operating Temperature Range:

BA3474F	-40°C to +75°C
BA3472xxx BA3474xxx	-40°C to +85°C
BA3472RFVM BA3474RFV	-40°C to +105°C
- High Slew Rate: 10V/μs(Typ.)
- Unity Gain Frequency: 4MHz(Typ.)

● **Block Diagram**

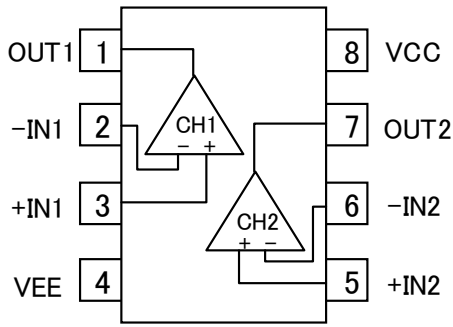

Figure 1. Simplified schematic (one channel only)

○Product structure : Silicon monolithic integrated circuit ○This product is not designed protection against radioactive rays.

●Pin Configuration (TOP VIEW)

SOP8, SOP-J8, SSOP-B8, TSSOP-B8, MSOP8



Pin No.	Symbol
1	OUT1
2	-IN1
3	+IN1
4	VEE
5	+IN2
6	-IN2
7	OUT2
8	VCC

SOP14, SSOP-B14, TSSOP-B14J

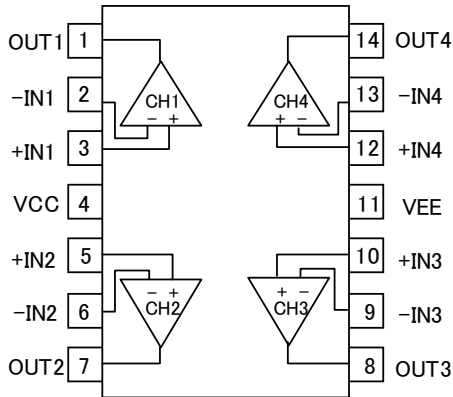

Pin No.	Symbol
1	OUT1
2	-IN1
3	+IN1
4	VCC
5	+IN2
6	-IN2
7	OUT2
8	OUT3
9	-IN3
10	+IN3
11	VEE
12	+IN4
13	-IN4
14	OUT4

Package							
SOP8	SSOP-B8	SOP-J8	TSSOP-B8	MSOP8	SOP14	SSOP-B14	TSSOP-B14J
BA3472F	BA3472FV	BA3472FJ	BA3472FVT	BA3472FVM BA3472RFVM	BA3474F	BA3474FV BA3474RFV	BA3474FVJ

●Ordering Information

B A 3 4 7 x x x x x	-	x x
Part Number BA3472xxx BA3472Rxxx BA3474xxx BA3474Rxx	Package F : SOP8 : SOP14 FV : SSOP-B8 : SSOP-B14 FJ : SOP-J8 FVT : TSSOP-B8 FVJ : TSSOP-B14J FVM: MSOP8	Packaging and forming specification E2: Embossed tape and reel (SOP8/SOP14/SSOP-B8/SSOP-B14 SOP-J8/TSSOP-B8/TSSOP-B14J) TR: Embossed tape and reel (MSOP8)

●Line-up

Topr	Supply Current (Typ.)	Slew Rate (Typ.)	Package		Orderable Part Number
-40°C to +75°C	8.0mA	10V/μs	SOP14	Reel of 2500	BA3474F-E2
	-40°C to +85°C		4.0mA	SOP8	Reel of 2500
SSOP-B8				Reel of 2500	BA3472FV-E2
SOP-J8				Reel of 2500	BA3472FJ-E2
TSSOP-B8				Reel of 2500	BA3472FVT-E2
MSOP8				Reel of 3000	BA3472FVM-TR
SSOP-B14				Reel of 2500	BA3474FV-E2
-40°C to +105°C	4.0mA		TSSOP-B14J	Reel of 2500	BA3474FVJ-E2
	8.0mA		MSOP8	Reel of 3000	BA3472RFVM-TR
			SSOP-B14	Reel of 2500	BA3474RFV-E2

● Absolute Maximum Ratings (Ta=25°C)

Parameter	Symbol	Ratings				Unit		
		BA3472	BA3474	BA3472R	BA3474R			
Supply Voltage	VCC-VEE	+36				V		
Power dissipation	Pd	SOP8	780 ^{*1*13}	-	-	-	mW	
		SSOP-B8	690 ^{*2*13}	-	-	-		
		MSOP8	590 ^{*3*13}	-	590 ^{*3*13}	-		-
			-	-	625 ^{*4*14}	-		-
			-	-	713 ^{*5*15}	-		-
		SOP-J8	675 ^{*7*13}	-	-	-		-
		TSSOP-B8	625 ^{*4*13}	-	-	-		-
		SOP14	-	610 ^{*8*13}	-	-		-
		SSOP-B14	-	870 ^{*9*13}	-	870 ^{*9*13}		-
			-	-	-	1187 ^{*10*15}		-
			-	-	-	1689 ^{*11*16}		-
		TSSOP-B14	-	850 ^{*12*13}	-	-		-
Differential Input Voltage ^{*17}	Vid	+36				V		
Input Common-mode Voltage Range	Vicm	(VEE - 0.3) to VEE + 36				V		
Operable with low voltage	Vopr	+3.0V to +36.0V (±1.5V to ±18.0V)				V		
Operating Temperature Range	Topr	-40 to +85(SOP14:to +75)		-40 to +105		°C		
Storage Temperature Range	Tstg	-55 to +150				°C		
Maximum Junction Temperature	Tjmax	+150				°C		

Note: Absolute maximum rating item indicates the condition which must not be exceeded.

Application of voltage in excess of absolute maximum rating or use out of absolute maximum rated temperature environment may cause deterioration of characteristics.

*1 To use at temperature above Ta=25°C reduce 6.2mW/°C.

*2 To use at temperature above Ta=25°C reduce 5.5mW/°C

*3 To use at temperature above Ta=25°C reduce 4.8mW/°C

*4 To use at temperature above Ta=25°C reduce 5.0mW/°C

*5 To use at temperature above Ta=25°C reduce 5.7mW/°C

*6 To use at temperature above Ta=25°C reduce 7.5mW/°C

*7 To use at temperature above Ta=25°C reduce 5.4mW/°C

*8 To use at temperature above Ta=25°C reduce 4.9mW/°C

*9 To use at temperature above Ta=25°C reduce 7.0mW/°C

*10 To use at temperature above Ta=25°C reduce 9.5mW/°C

*11 To use at temperature above Ta=25°C reduce 13.5mW/°C

*12 To use at temperature above Ta=25°C reduce 6.8mW/°C

*13 Mounted on a FR4 glass epoxy PCB(70mm×70mm×1.6mm).

*14 Mounted on a FR4 glass epoxy 2 layers PCB 70mm × 70mm × 1.6mm (occupied copper area : 15mm × 15mm).

*15 Mounted on a FR4 glass epoxy 2 layers PCB 70mm × 70mm × 1.6mm (occupied copper area : 70mm × 70mm).

*16 Mounted on a FR4 glass epoxy 4 layers PCB 70mm × 70mm × 1.6mm (occupied copper area : 70mm × 70mm).

*17 The voltage difference between inverting input and non-inverting input is the differential input voltage.

Then input terminal voltage is set to more than VEE.

● Electrical Characteristics

OBA3472 (Unless otherwise specified VCC=+15V, VEE=-15V, Ta=25°C)

Parameter	Symbol	Limits			Unit	Condition
		Min.	Typ.	Max.		
Input Offset Voltage ^{*18}	Vio	-	1	10	mV	Vicm=0V, VOUT=0V
		-	1	10		VCC=5V, VEE=0V, Vicm=0V VOUT=VCC/2
Input Offset Current ^{*18}	Iio	-	6	75	nA	Vicm=0V, VOUT=0V
Input Bias Current ^{*18}	Ib	-	100	500	nA	Vicm=0V, VOUT=0V
Supply Current	ICC	-	4	5.5	mA	RL=∞
Maximum Output Voltage(High)	VOH	3.7	4	-	V	VCC=5V, RL=2kΩ
		13.7	14	-		RL=10kΩ
		13.5	-	-		RL=2kΩ
Maximum Output Voltage(Low)	VOL	-	0.1	0.3	V	VCC=5V, RL=2kΩ
		-	-14.7	-14.3		RL=10kΩ
		-	-	-13.5		RL=2kΩ
Large Signal Voltage Gain	Av	80	100	-	dB	RL ≥ 2kΩ, VOUT=±10 V
Input Common-mode Voltage Range	Vicm	0	-	VCC-2.0	V	VCC=5V, VEE=0V VOUT=VCC/2
Common-mode Rejection Ratio	CMRR	60	97	-	dB	Vicm=0V, VOUT=0V
Power Supply Rejection Ratio	PSRR	60	97	-	dB	Vicm=0V, VOUT=0V
Output Source Current ^{*19}	Isource	10	30	-	mA	VCC=5V, VIN+=1V VIN-=0V, VOUT=0V Only 1ch is short circuit
Output Sink Current ^{*19}	Isink	20	30	-	mA	VCC=5V, VIN+=0V VIN-=1V, VOUT=5V Only 1ch is short circuit
Unity Gain Frequency	f _T	-	4	-	MHz	-
Gain Band Width	GBW	-	4	-	MHz	f=100kHz open loop
Slew Rate	SR	-	10	-	V/μs	Av=1, Vin=-10 to +10V RL=2kΩ
Channel Separation	CS	-	120	-	dB	f=1kHz, input referred

^{*18} Absolute value^{*19} Under high temperatures, please consider the power dissipation when selecting the output current.

When the output terminal is continuously shorted the output current reduces the internal temperature by flushing.

OBA3472R (Unless otherwise specified VCC=+15V, VEE=-15V, Ta=25°C)

Parameter	Symbol	Limits			Unit	Condition
		Min.	Typ.	Max.		
Input Offset Voltage ^{*20}	Vio	-	1	10	mV	Vicm=0V, VOUT=0V
		-	1	10		VCC=5V, VEE=0V, Vicm=0V VOUT=VCC/2
Input Offset Current ^{*20}	Iio	-	6	75	nA	Vicm=0V, VOUT=0V
Input Bias Current ^{*20}	Ib	-	100	500	nA	Vicm=0V, VOUT=0V
Supply Current	ICC	-	4	5.5	mA	RL=∞
Maximum Output Voltage(High)	VOH	3.7	4	-	V	VCC=5V, RL=2kΩ
		13.7	14	-		RL=10kΩ
		13.5	-	-		RL=2kΩ
Maximum Output Voltage(Low)	VOL	-	0.1	0.3	V	VCC=5V, RL=2kΩ
		-	-14.7	-14.3		RL=10kΩ
		-	-	-13.5		RL=2kΩ
Large Signal Voltage Gain	Av	80	100	-	dB	RL ≥ 2kΩ, VOUT=±10 V
Input Common-mode Voltage Range	Vicm	0	-	VCC-2.0	V	VCC=5V, VEE=0V VOUT=VCC/2
Common-mode Rejection Ratio	CMRR	60	97	-	dB	Vicm=0V, VOUT=0V
Power Supply Rejection Ratio	PSRR	60	97	-	dB	Vicm=0V, VOUT=0V
Output Source Current ^{*21}	Isource	10	30	-	mA	VCC=5V, VIN+=1V VIN-=0V, VOUT=0V Only 1ch is short circuit
Output Sink Current ^{*21}	Isink	20	30	-	mA	VCC=5V, VIN+=0V VIN-=1V, VOUT=5V Only 1ch is short circuit
Unity Gain Frequency	f _T	-	4	-	MHz	-
Gain Band Width	GBW	-	4	-	MHz	f=100kHz open loop
Slew Rate	SR	-	10	-	V/μs	Av=1, Vin=-10 to +10V, RL=2kΩ
Channel Separation	CS	-	120	-	dB	f=1kHz, input referred

*20 Absolute value

*21 Under high temperatures, please consider the power dissipation when selecting the output current.

When the output terminal is continuously shorted the output current reduces the internal temperature by flushing.

OBA3474 (Unless otherwise specified VCC=+15V, VEE=-15V, Ta=25°C)

Parameter	Symbol	Limits			Unit	Condition
		Min.	Typ.	Max.		
Input Offset Voltage ^{*22}	Vio	-	1	10	mV	Vicm=0V, VOUT=0V
		-	1	10		VCC=5V, VEE=0V, Vicm=0V VOUT=VCC/2
Input Offset Current ^{*22}	Iio	-	6	75	nA	Vicm=0V, VOUT=0V
Input Bias Current ^{*22}	Ib	-	100	500	nA	Vicm=0V, VOUT=0V
Supply Current	ICC	-	8	11	mA	RL=∞
Maximum Output Voltage(High)	VOH	3.7	4	-	V	VCC=5V, RL=2kΩ
		13.7	14	-		RL=10kΩ
		13.5	-	-		RL=2kΩ
Maximum Output Voltage(Low)	VOL	-	0.1	0.3	V	VCC=5V, RL=2kΩ
		-	-14.7	-14.3		RL=10kΩ
		-	-	-13.5		RL=2kΩ
Large Signal Voltage Gain	Av	80	100	-	dB	RL ≥ 2kΩ, VOUT=±10 V
Input Common-mode Voltage Range	Vicm	0	-	VCC-2.0	V	VCC=5V, VEE=0V, VOUT=VCC/2
Common-mode Rejection Ratio	CMRR	60	97	-	dB	Vicm=0V, VOUT=0V
Power Supply Rejection Ratio	PSRR	60	97	-	dB	Vicm=0V, VOUT=0V
Output Source Current ^{*23}	Isource	10	30	-	mA	VCC=5V, VIN+=1V VIN-=0V, VOUT=0V Only 1ch is short circuit
Output Sink Current ^{*23}	Isink	20	30	-	mA	VCC=5V, VIN+=0V VIN-=1V, VOUT=5V Only 1ch is short circuit
Unity Gain Frequency	f _T	-	4	-	MHz	-
Gain Band Width	GBW	-	4	-	MHz	f=100kHz open loop
Slew Rate	SR	-	10	-	V/μs	Av=1, Vin=-10 to +10V, RL=2kΩ
Channel Separation	CS	-	120	-	dB	f=1kHz, input referred

*22 Absolute value

*23 Under high temperatures, please consider the power dissipation when selecting the output current.

When the output terminal is continuously shorted the output current reduces the internal temperature by flushing.

OBA3474R (Unless otherwise specified VCC=+15V, VEE=-15V, Ta=25°C)

Parameter	Symbol	Limits			Unit	Condition
		Min.	Typ.	Max.		
Input Offset Voltage ^{*24}	Vio	-	1	10	mV	Vicm=0V, VOUT=0V
		-	1	10		VCC=5V, VEE=0V, Vicm=0V VOUT=VCC/2
Input Offset Current ^{*24}	Iio	-	6	75	nA	Vicm=0V, VOUT=0V
Input Bias Current ^{*24}	Ib	-	100	500	nA	Vicm=0V, VOUT=0V
Supply Current	ICC	-	8	11	mA	RL=∞
Maximum Output Voltage(High)	VOH	3.7	4	-	V	VCC=5V, RL=2kΩ
		13.7	14	-		RL=10kΩ
		13.5	-	-		RL=2kΩ
Maximum Output Voltage(Low)	VOL	-	0.1	0.3	V	VCC=5V, RL=2kΩ
		-	-14.7	-14.3		RL=10kΩ
		-	-	-13.5		RL=2kΩ
Large Signal Voltage Gain	Av	80	100	-	dB	RL ≥ 2kΩ, VOUT=±10 V
Input Common-mode Voltage Range	Vicm	0	-	VCC-2.0	V	VCC=5V, VEE=0V, VOUT=VCC/2
Common-mode Rejection Ratio	CMRR	60	97	-	dB	Vicm=0V, VOUT=0V
Power Supply Rejection Ratio	PSRR	60	97	-	dB	Vicm=0V, VOUT=0V
Output Source Current ^{*25}	Isource	10	30	-	mA	VCC=5V, VIN+=1V VIN-=0V, VOUT=0V Only 1ch is short circuit
Output Sink Current ^{*25}	Isink	20	30	-	mA	VCC=5V, VIN+=0V VIN-=1V, VOUT=5V Only 1ch is short circuit
Unity Gain Frequency	f _T	-	4	-	MHz	-
Gain Band Width	GBW	-	4	-	MHz	f=100kHz open loop
Slew Rate	SR	-	10	-	V/μs	Av=1, Vin=-10 to +10V, RL=2kΩ
Channel Separation	CS	-	120	-	dB	f=1kHz, input referred

*24 Absolute value

*25 Under high temperatures, please consider the power dissipation when selecting the output current.

When the output terminal is continuously shorted the output current reduces the internal temperature by flushing.

Description of Electrical Characteristics

Described below are descriptions of the relevant electrical terms

Please note that item names, symbols and their meanings may differ from those on another manufacturer's documents.

1. Absolute maximum ratings

The absolute maximum ratings are values that should never be exceeded, since doing so may result in deterioration of electrical characteristics or damage to the part itself as well as peripheral components.

1.1 Power supply voltage (VCC/VEE)

Expresses the maximum voltage that can be supplied between the positive and negative supply terminals without causing deterioration of the electrical characteristics or destruction of the internal circuitry.

1.2 Differential input voltage (Vid)

Indicates the maximum voltage that can be supplied between the non-inverting and inverting terminals without damaging the IC.

1.3 Input common-mode voltage range (Vicm)

Signifies the maximum voltage that can be supplied to non-inverting and inverting terminals without causing deterioration of the characteristics or damage to the IC itself. Normal operation is not guaranteed within the common-mode voltage range of the maximum ratings – use within the input common-mode voltage range of the electric characteristics instead.

1.4 Power dissipation (Pd)

Indicates the power that can be consumed by a particular mounted board at ambient temperature (25°C). For packaged products, Pd is determined by the maximum junction temperature and the thermal resistance.

2. Electrical characteristics

2.1 Input offset voltage (Vio)

Indicates the voltage difference between non-inverting terminal and inverting terminal. It can be translated into the input voltage difference required for setting the output voltage at 0 V.

2.2 Input offset current (Iio)

Indicates the difference of input bias current between the non-inverting and inverting terminals.

2.3 Input bias current (Ib)

Indicates the current that flows into or out of the input terminal. It is defined by the average of input bias current at non-inverting terminal and input bias current at inverting terminal.

2.4 Circuit current (ICC)

Indicates the current of the IC itself that flows under specified conditions and during no-load steady state.

2.5 Maximum Output Voltage(High) / Maximum Output Voltage(Low) (VOH/VOL)

Indicates the voltage range that can be output by the IC under specified load condition. It is typically divided into maximum output voltage High and low. Maximum output voltage high indicates the upper limit of output voltage. Maximum output voltage low indicates the lower limit.

2.6 Large signal voltage gain (Av)

The amplifying rate (gain) of the output voltage against the voltage difference between non-inverting and inverting terminals, it is (normally) the amplifying rate (gain) with respect to DC voltage.

$$A_V = (\text{output voltage fluctuation}) / (\text{input offset fluctuation})$$

2.7 Input common-mode voltage range (Vicm)

Indicates the input voltage range under which the IC operates normally.

2.8 Common-mode rejection ratio (CMRR)

Indicates the ratio of fluctuation of input offset voltage when in-phase input voltage is changed. It is normally the fluctuation of DC.

$$CMRR = (\text{Change of Input common-mode voltage}) / (\text{Input offset fluctuation})$$

2.9 Power supply rejection ratio (PSRR)

Indicates the ratio of fluctuation of input offset voltage when supply voltage is changed. It is normally the fluctuation of DC. PSRR = (Change of power supply voltage) / (Input offset fluctuation)

2.10 Output source current/ output sink current (Isource/Isink)

The maximum current that can be output under specific output conditions, it is divided into output source current and output sink current. The output source current indicates the current flowing out of the IC, and the output sink current the current flowing into the IC.

2.11 Unity gain frequency (f_T)

Indicates a frequency where the voltage gain of operational amplifier is 1.

2.12 Gain Band Width (GBW)

Indicates to multiply by the frequency and the gain where the voltage gain decreases 6dB/octave.

2.13 Slew Rate (SR)

SR is a parameter that shows movement speed of operational amplifier. It indicates rate of variable output voltage as unit time.

2.14 Channel separation (CS)

Indicates the fluctuation of input offset voltage or that of output voltage with reference to the change of output voltage of driven channel.

● Typical Performance Curves

○ BA3472, BA3472R

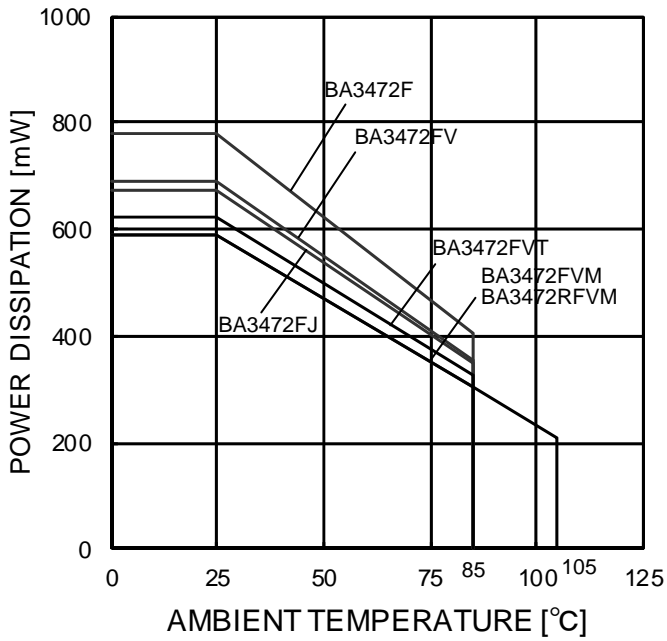

Figure 2.
Derating Curve

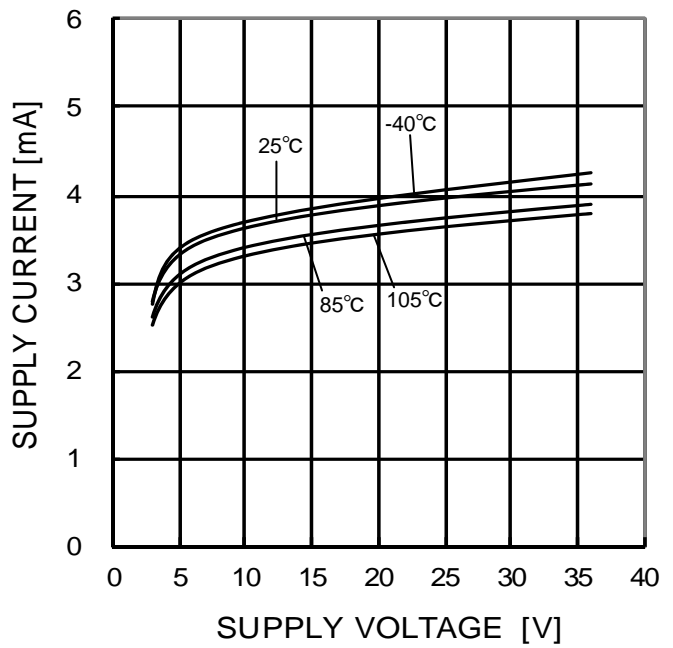

Figure 3.
Supply Current - Supply Voltage



Figure 4.
Supply Current - Ambient Temperature



Figure 5.
High level Output Voltage - Supply Voltage
(RL=10kΩ)

(*) The above data is measurement value of typical sample, it is not guaranteed.
BA3472 : -40°C~+85°C BA3472R : -40°C~+105°C

OBA3472, BA3472R



Figure 6.
High level Output Voltage
- Ambient Temperature
(RL=10kΩ)

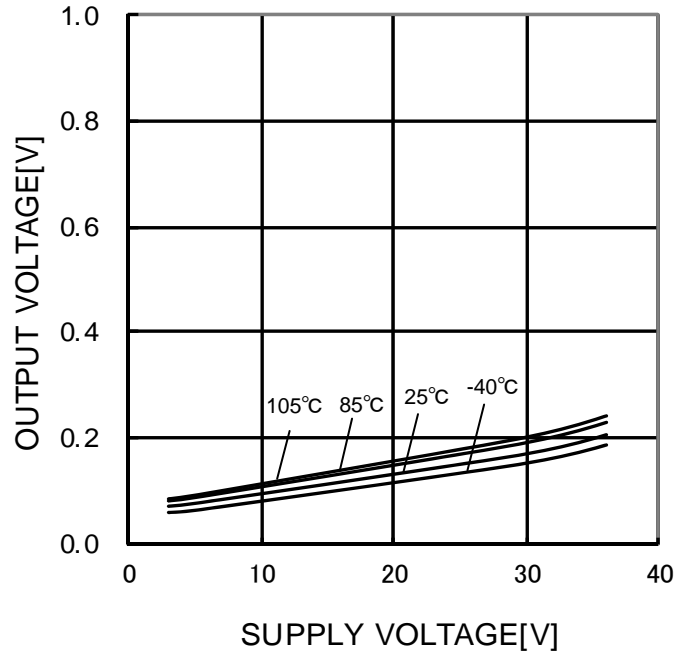

Figure 7.
Low level Output Voltage
- Supply Voltage
(RL=10kΩ)

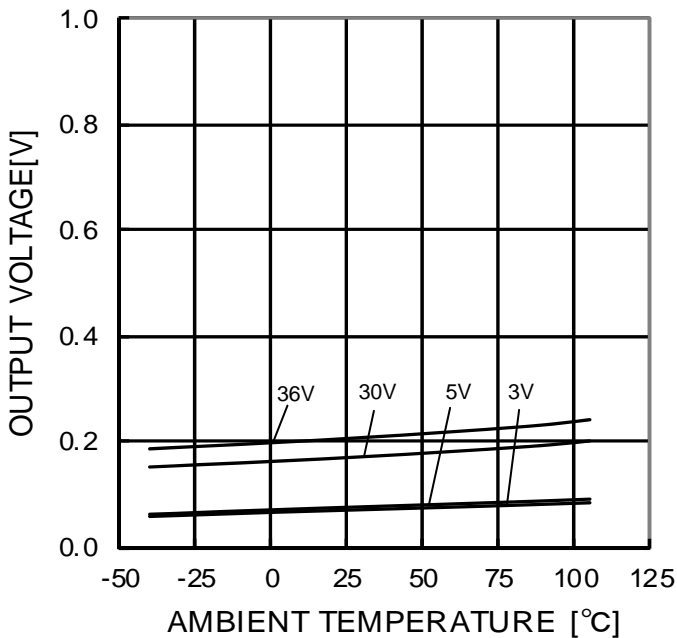

Figure 8.
Low level Output Voltage
- Ambient Temperature
(RL=10kΩ)

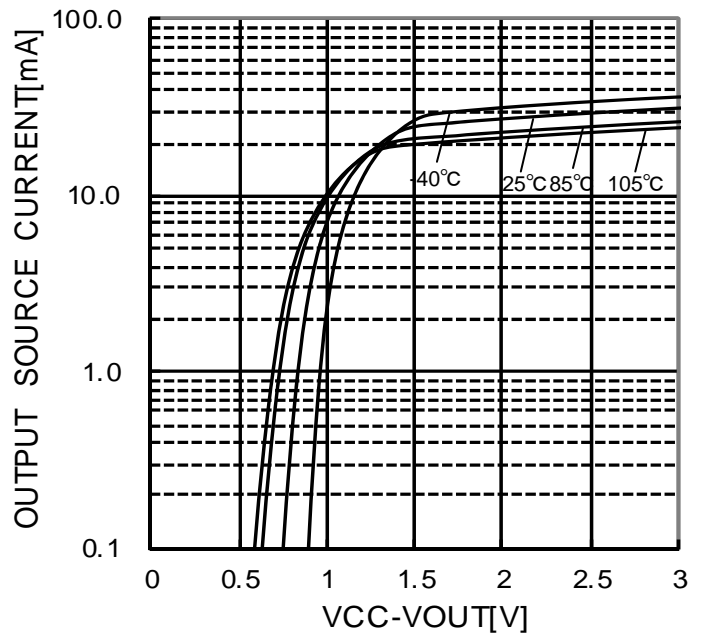

Figure 9.
Output Source Current - (VCC-VOUT)
(VCC/VEE=5V/0V)

(*) The above data is measurement value of typical sample, it is not guaranteed.
BA3472 : -40°C~+85°C BA3472R : -40°C~+105°C

OBA3472, BA3472R

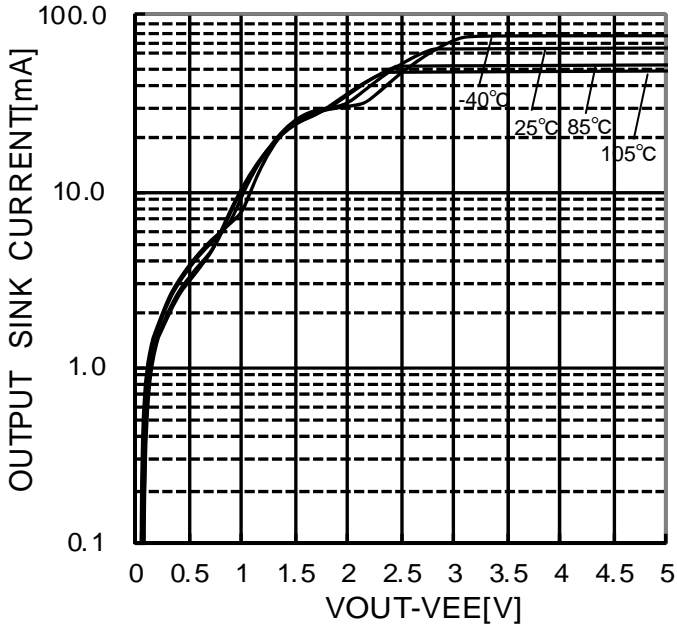

Figure 10.
Output Sink Current - (VOUT-VEE)
(VCC/VEE=5V/0V)

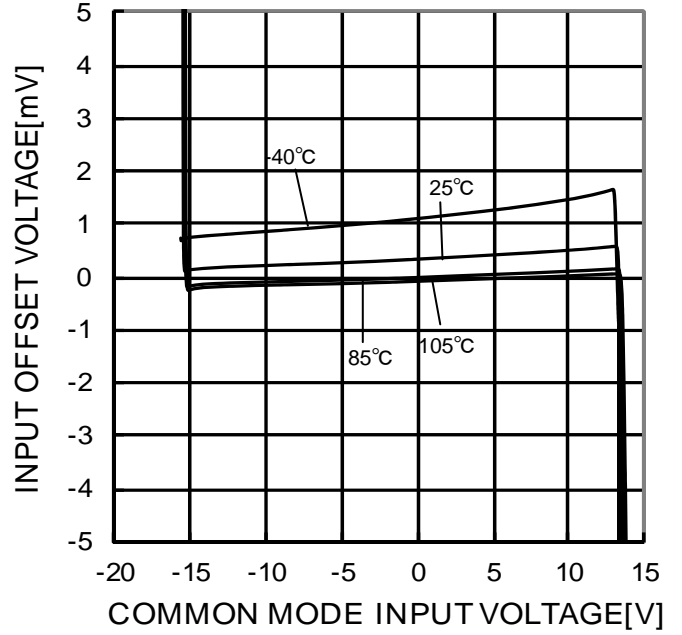

Figure 11.
Input Offset Voltage
- Common Mode Input Voltage
(VCC/VEE=15V/-15V)

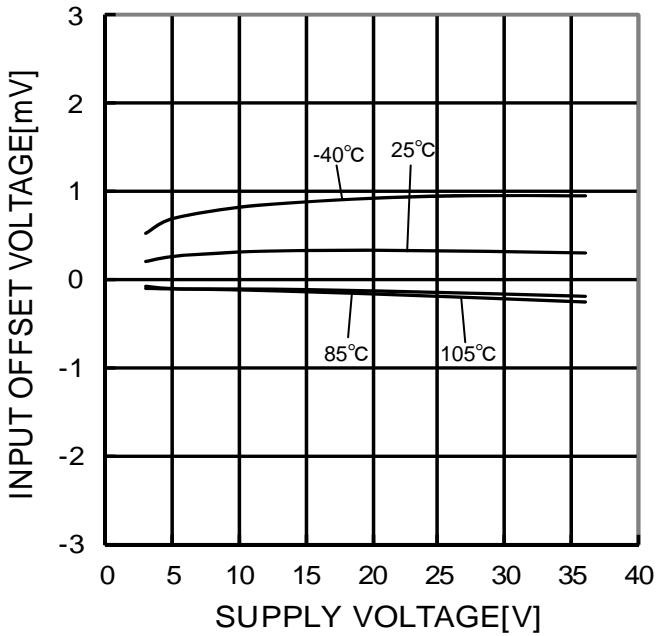

Figure 12.
Input Offset Voltage - Supply voltage

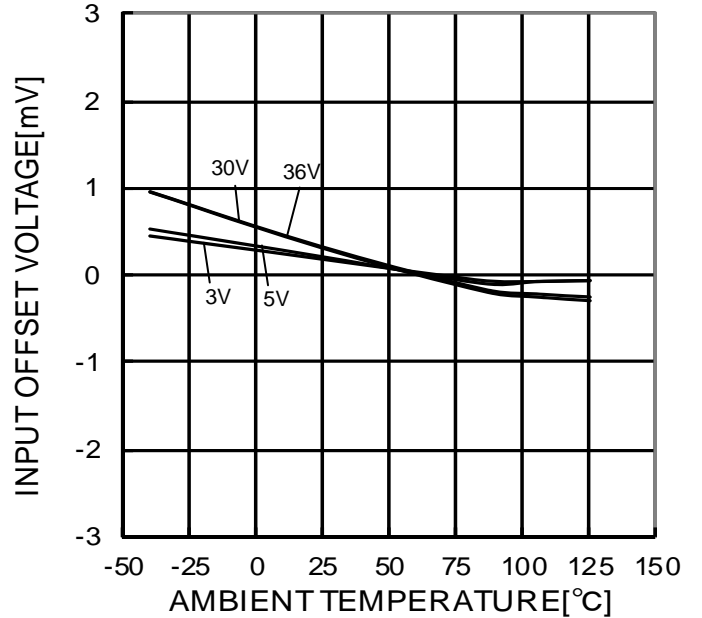

Figure 13.
Input Offset Voltage - Ambient Temperature

(*) The above data is measurement value of typical sample, it is not guaranteed.
BA3472 : -40°C~+85°C BA3472R : -40°C~+105°C

OBA3472, BA3472R

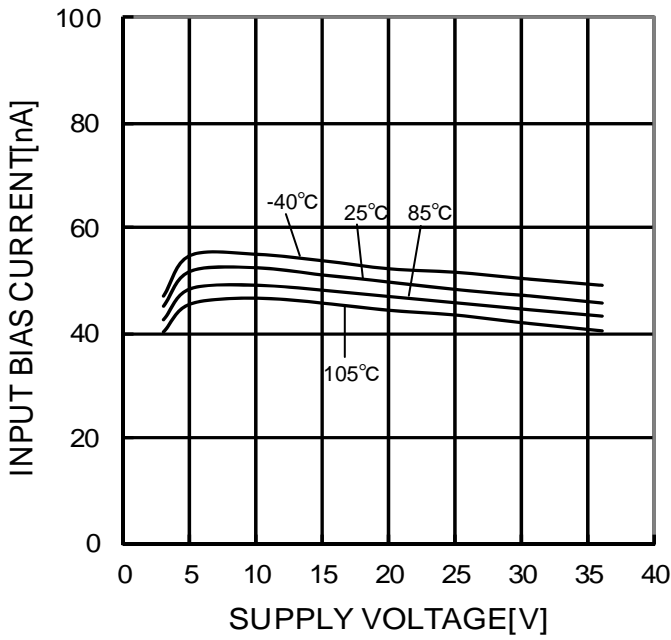

Figure 14.
Input Bias Current - Supply voltage

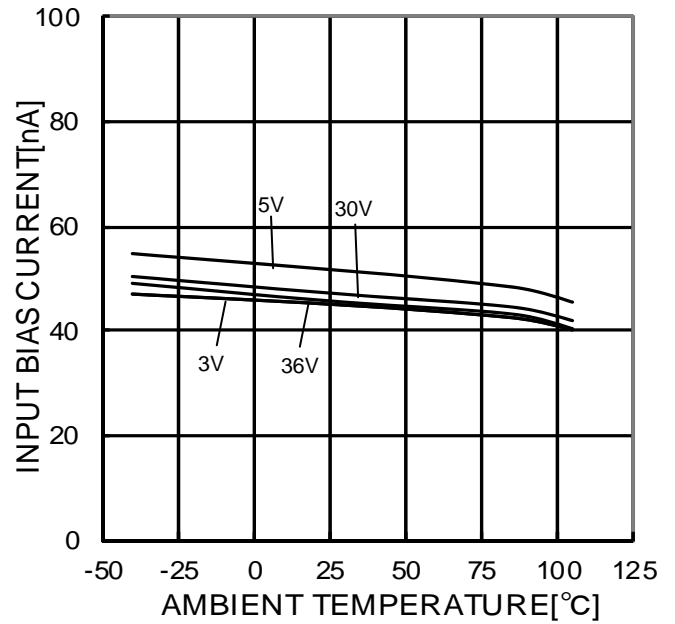

Figure 15.
Input Bias Current - Ambient Temperature

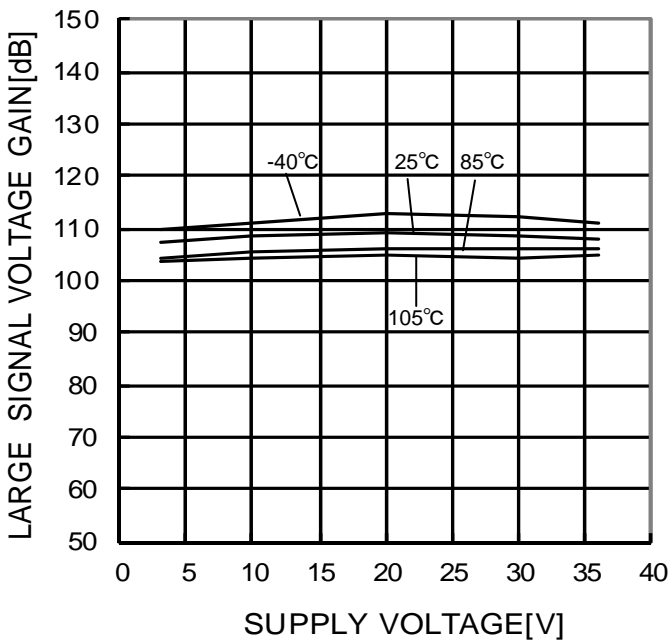

Figure 16.
Large Signal Voltage Gain
- Supply Voltage

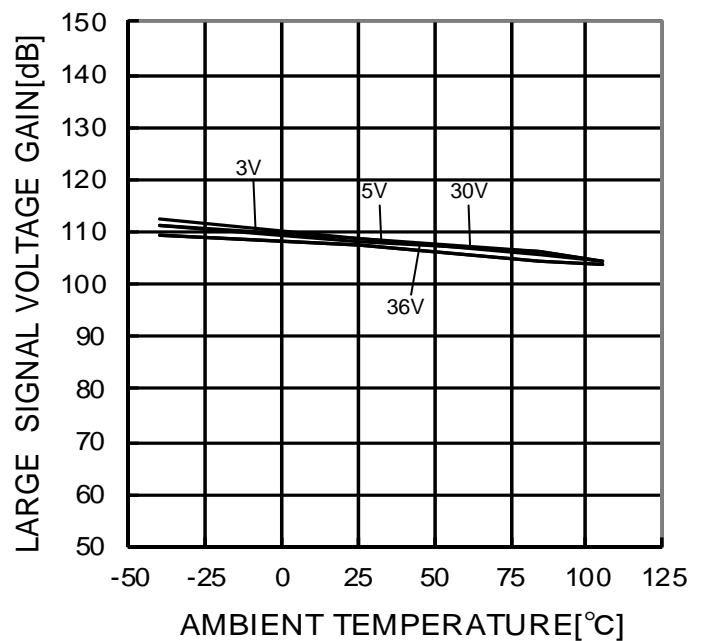

Figure 17.
Large Signal Voltage Gain
- Ambient Temperature

(*) The above data is measurement value of typical sample, it is not guaranteed.
BA3472 : -40°C~+85°C BA3472R : -40°C~+105°C

OBA3472, BA3472R

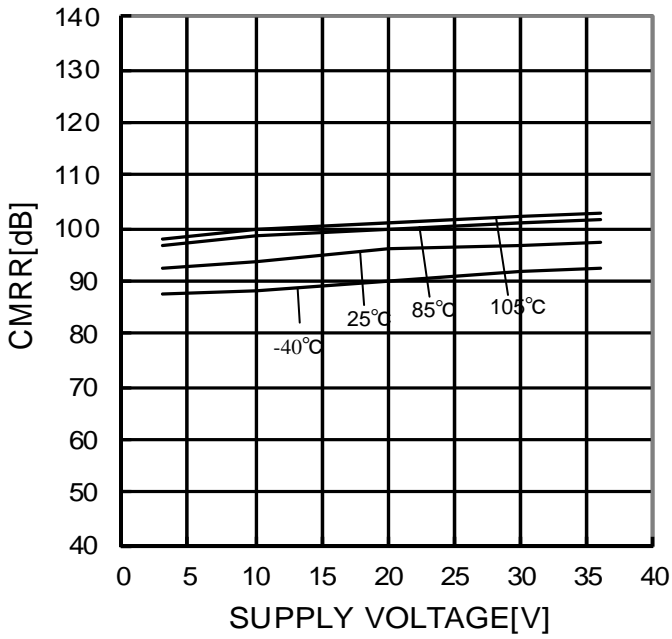

Figure 18.
Common Mode Rejection Ratio
- Supply Voltage

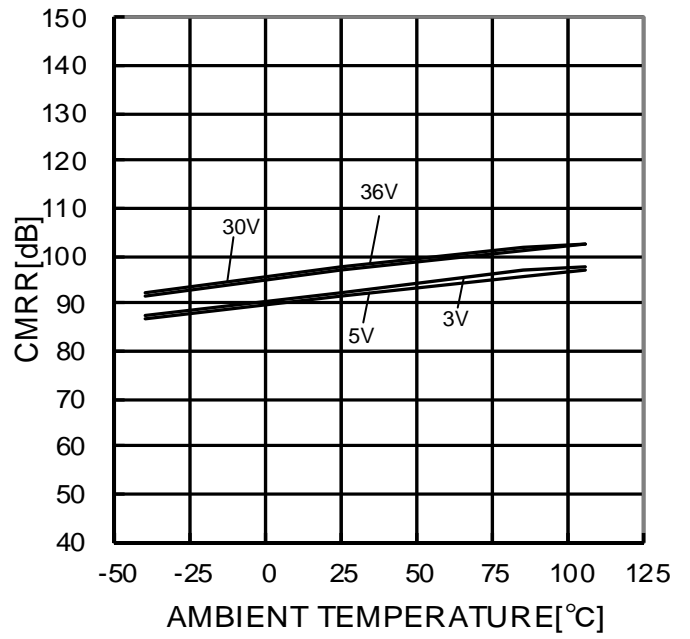

Figure 19.
Common Mode Rejection Ratio
- Ambient Temperature

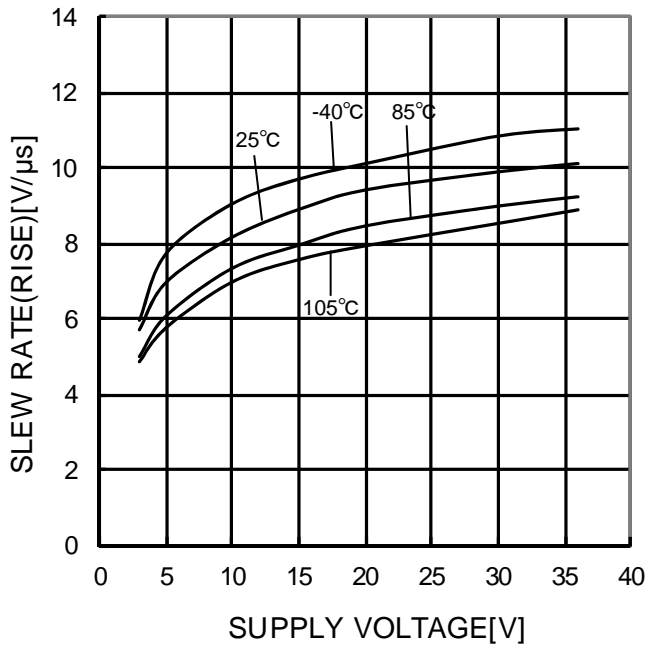

Figure 20.
Slew Rate L-H - Supply Voltage
(RL=10kΩ)

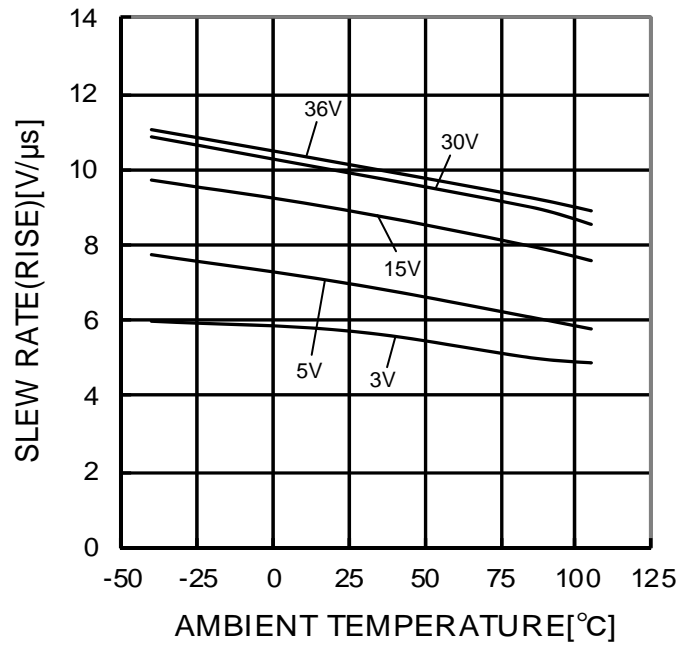

Figure 21.
Slew Rate L-H - Ambient Temperature
(RL=10kΩ)

(*) The above data is measurement value of typical sample, it is not guaranteed.
BA3472 : -40°C~+85°C BA3472R : -40°C~+105°C

OBA3472, BA3472R

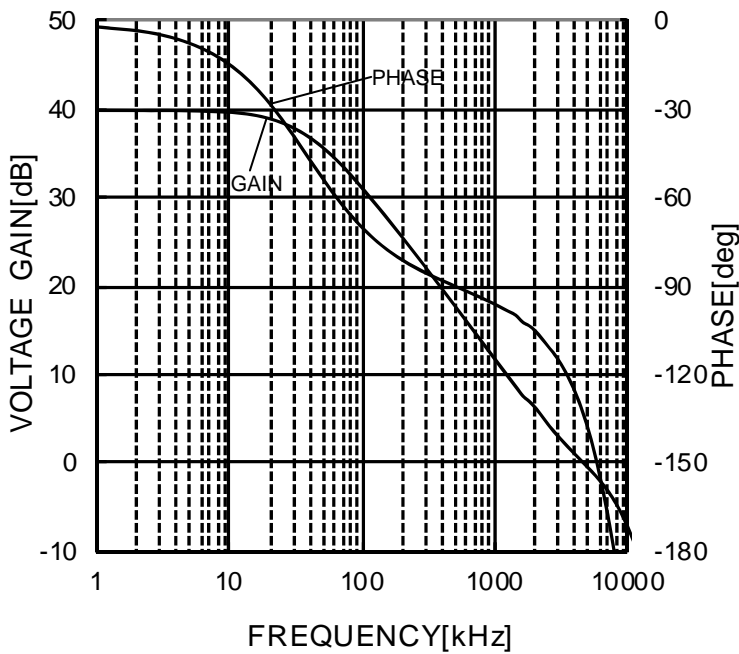

Figure 22.
Voltage Gain · Phase - Frequency
(VCC=7.5V/-7.5V, Av=40dB,
RL=2kΩ, CL=100pF, Ta=25°C)



Figure 23.
Input / Output Voltage - Time
(VCC/VEE=15V/-15V, Av=0dB,
RL=2kΩ, CL=100pF, Ta=25°C)

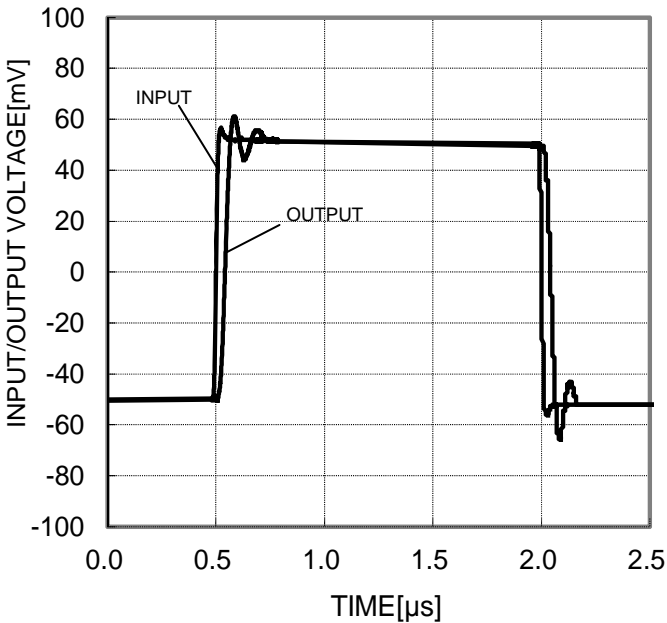

Figure 24.
Input / Output Voltage - Time
(VCC/VEE=15V/-15V, Av=0dB,
RL=2kΩ, CL=100pF, Ta=25°C)

(*) The above data is measurement value of typical sample, it is not guaranteed.
BA3472 : -40°C~+85°C BA3472R : -40°C~+105°C

OBA3474, BA3474R

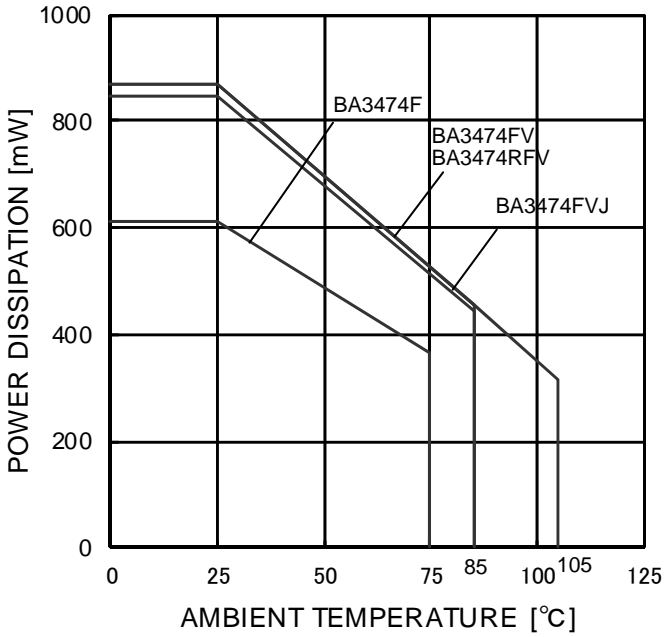

Figure 25.
Derating Curve



Figure 26.
Supply Current - Supply Voltage

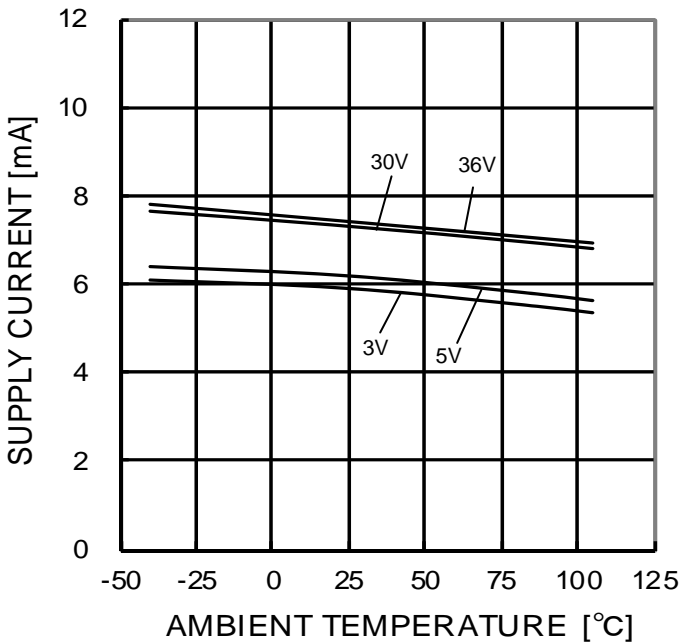

Figure 27.
Supply Current - Ambient Temperature



Figure 28.
High level Output Voltage
- Supply Voltage
(RL=10kΩ)

(*) The above data is measurement value of typical sample, it is not guaranteed.
BA3474F : -40°C~+75°C BA3474 : -40°C~+85°C BA3474R : -40°C~+105°C

OBA3474, BA3474R

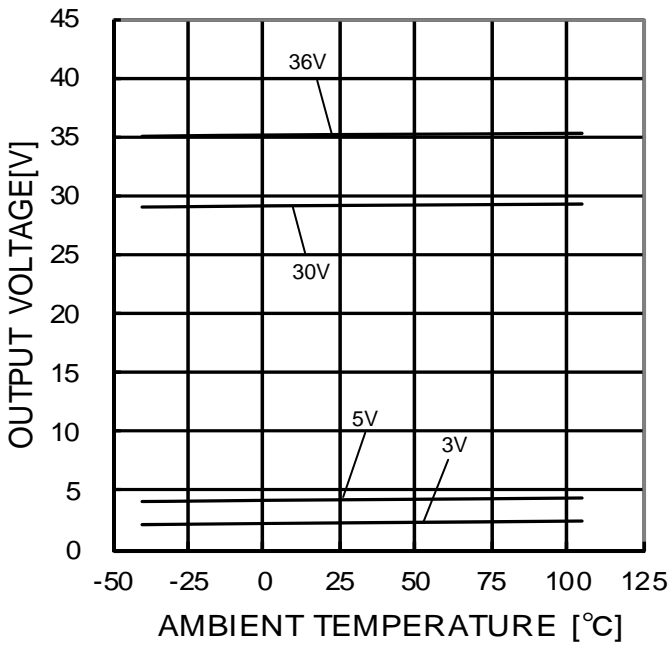

Figure 29.
High level Output Voltage
- Ambient Temperature
($R_L=10k\Omega$)

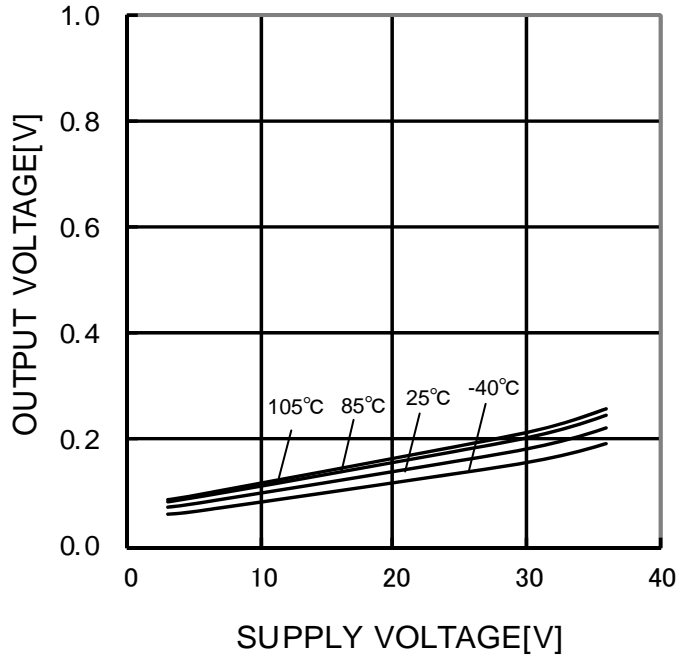

Figure 30.
Low level Output Voltage
- Supply Voltage
($R_L=10k\Omega$)

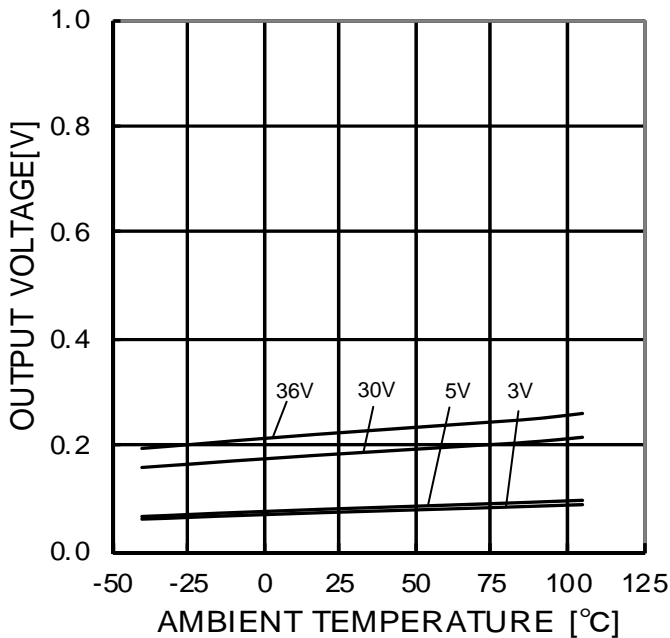

Figure 31.
Low level Output Voltage
- Ambient Temperature
($R_L=10k\Omega$)

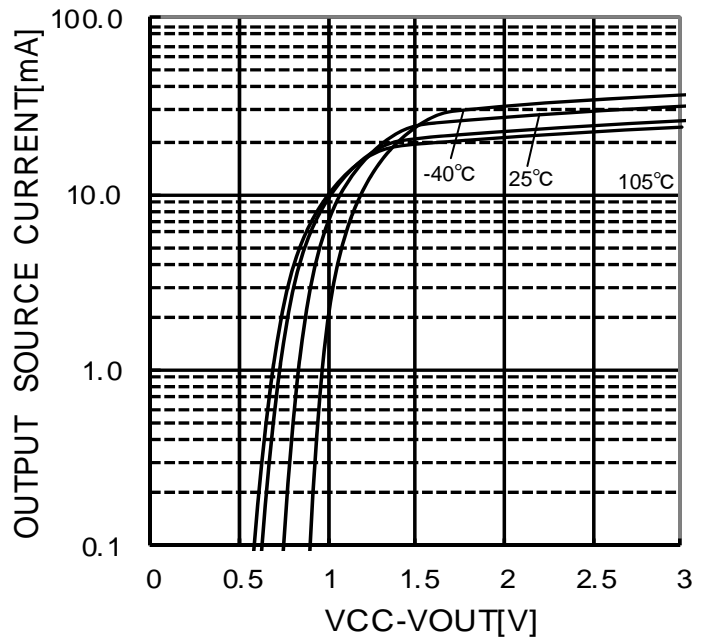

Figure 32.
Output Source Current - ($V_{CC}-V_{OUT}$)
($V_{CC}/V_{EE}=5V/0V$)

(*) The above data is measurement value of typical sample, it is not guaranteed.
BA3474F : -40°C~+75°C BA3474 : -40°C~+85°C BA3474R : -40°C~+105°C

OBA3474, BA3474R



Figure 33.
Output Sink Current - (VOUT-VEE)
(VCC/VEE=5V/0V)



Figure 34.
Input Offset Voltage
- Common Model Input Voltage
(VCC/VEE=15V/-15V)

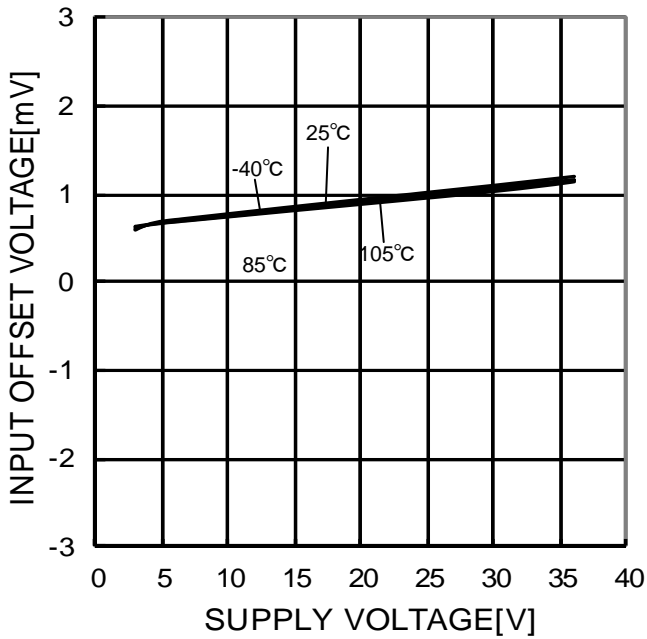

Figure 35.
Input Offset Voltage - Supply voltage

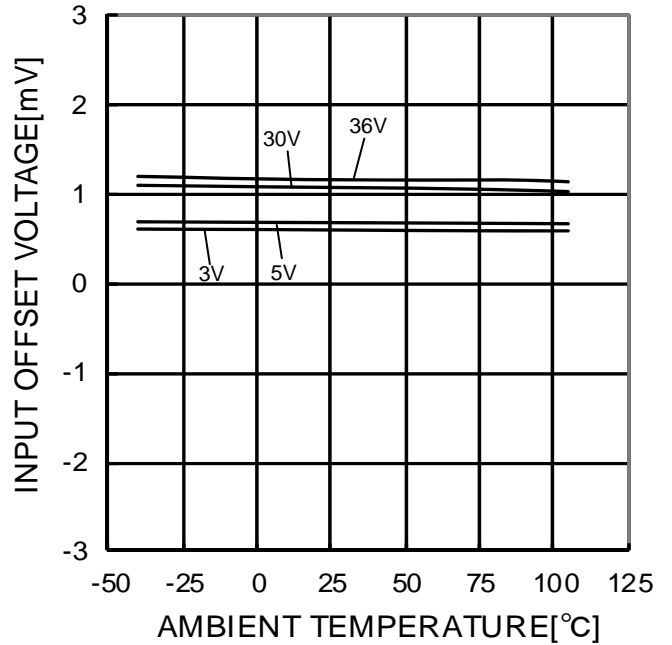

Figure 36.
Input Offset Voltage - Ambient Temperature

(*) The above data is measurement value of typical sample, it is not guaranteed.
BA3474F : -40°C~+75°C BA3474 : -40°C~+85°C BA3474R : -40°C~+105°C

OBA3474, BA3474R

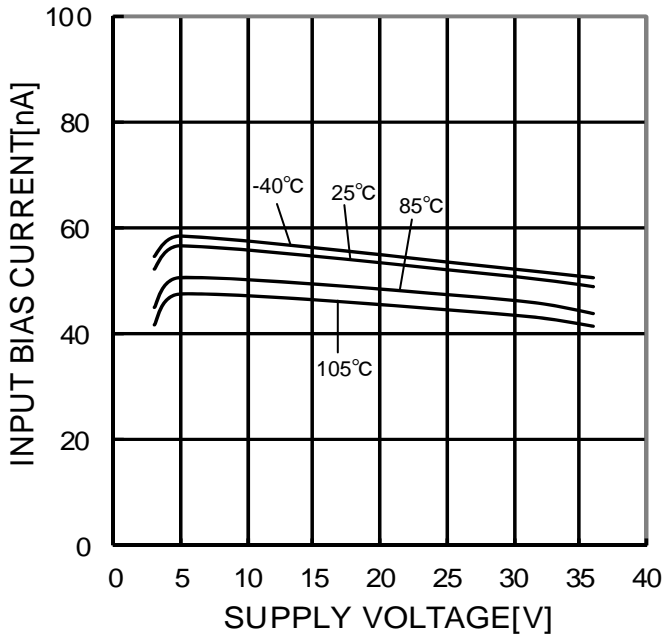

Figure 37.
Input Bias Current - Supply voltage



Figure 38.
Input Bias Current - Ambient Temperature

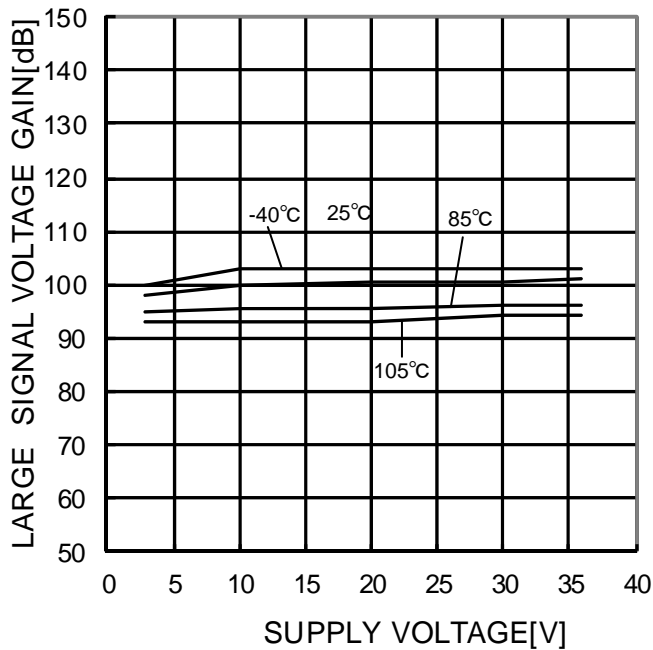

Figure 39.
Large Signal Voltage Gain
- Supply Voltage

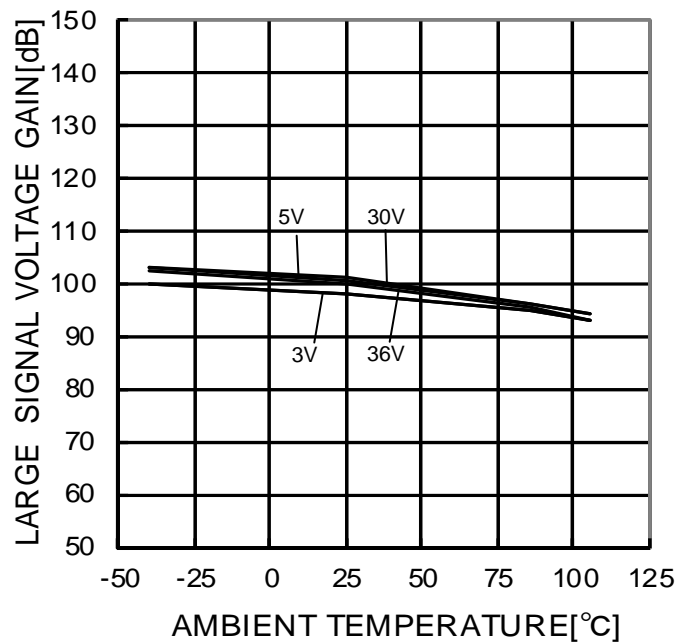

Figure 40.
Large Signal Voltage Gain
- Ambient Temperature

(*) The above data is measurement value of typical sample, it is not guaranteed.
BA3474F : -40°C~+75°C BA3474 : -40°C~+85°C BA3474R : -40°C~+105°C

OBA3474, BA3474R

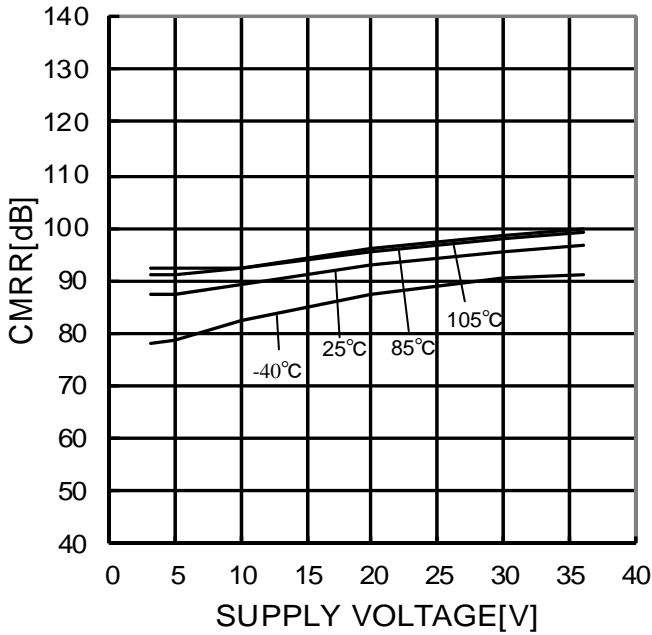

Figure 41.
Common Mode Rejection Ratio
- Supply Voltage

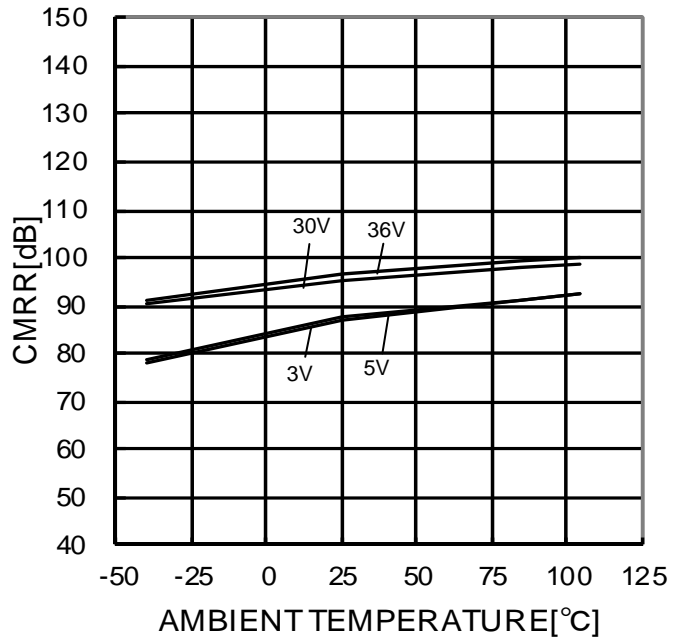

Figure 42.
Common Mode Rejection Ratio
- Ambient Temperature

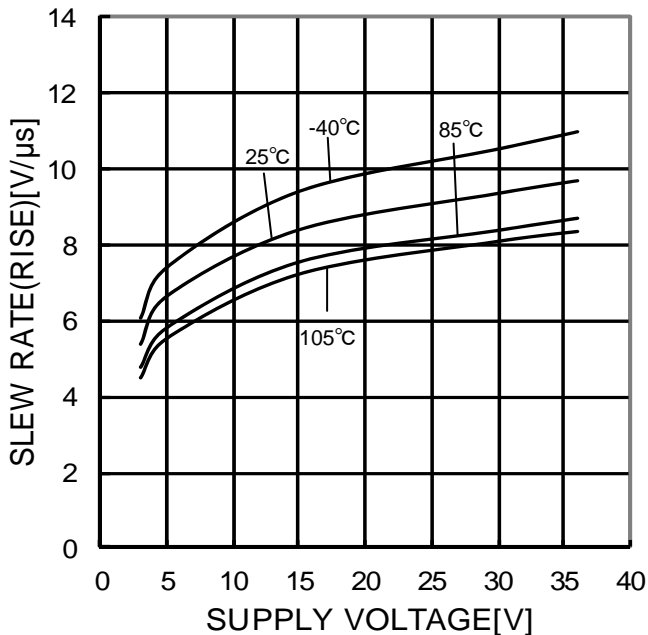

Figure 43.
Slew Rate L-H - Supply Voltage
(RL=10kΩ)

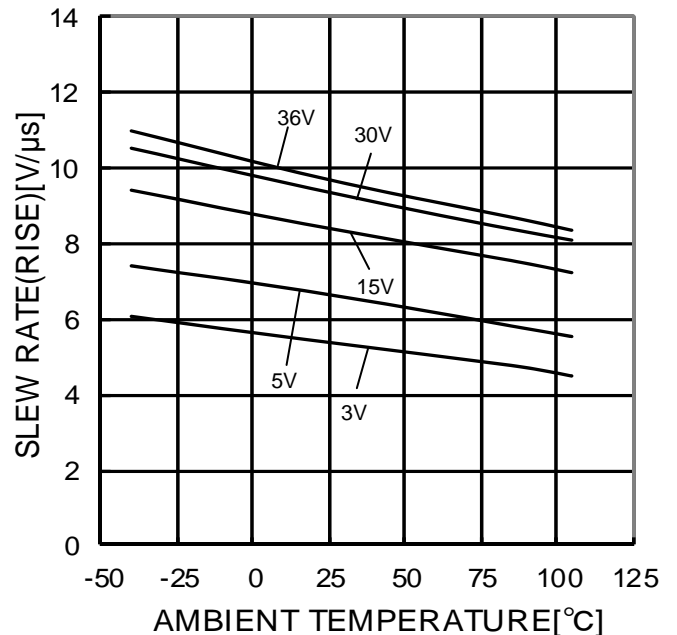

Figure 44.
Slew Rate L-H - Ambient Temperature
(RL=10kΩ)

(*) The above data is measurement value of typical sample, it is not guaranteed.
BA3474F : -40°C~+75°C BA3474 : -40°C~+85°C BA3474R : -40°C~+105°C

OBA3474, BA3474R



Figure 45.
Voltage Gain · Phase - Frequency
(VCC=7.5V/-7.5V, Av=40dB,
RL=2kΩ, CL=100pF, Ta=25°C)



Figure 46.
Input / Output Voltage - Time
(VCC/VEE=15V/-15V, Av=0dB,
RL=2kΩ, CL=100pF, Ta=25°C)

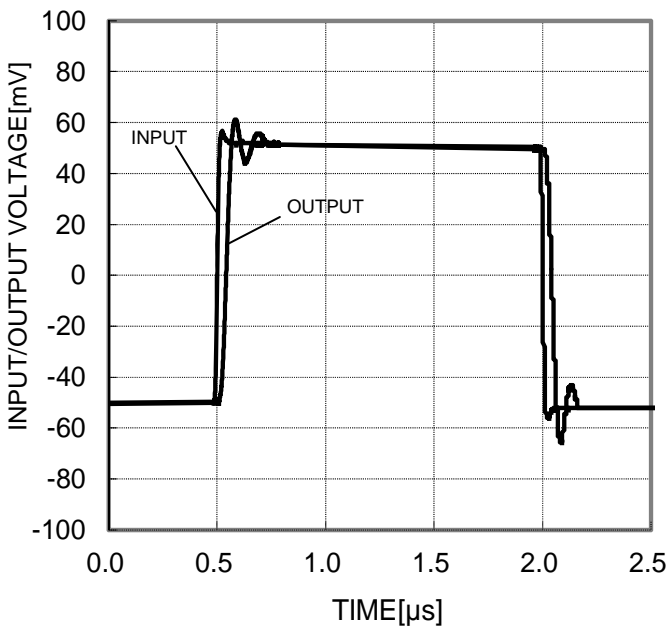

Figure 47.
Input / Output Voltage - Time
(VCC/VEE=15V/-15V, Av=0dB,
RL=2kΩ, CL=100pF, Ta=25°C)

(*) The above data is measurement value of typical sample, it is not guaranteed.
BA3474F : -40°C~+75°C BA3474 : -40°C~+85°C BA3474R : -40°C~+105°C

●Application Information

NULL method condition for Test Circuit 1

VCC, VEE, EK, Vicm Unit : V

Parameter	VF	S1	S2	S3	VCC	VEE	EK	Vicm	Calculation
Input Offset Voltage	VF1	ON	ON	OFF	15	-15	0	0	1
Input Offset Current	VF2	OFF	OFF	OFF	15	-15	0	0	2
Input Bias Current	VF3	OFF	ON	OFF	15	-15	0	0	3
	VF4	ON	OFF						
Large Signal Voltage Gain	VF5	ON	ON	ON	15	-15	+10	0	4
	VF6				15	-15	-10	0	
Common-mode Rejection Ratio (Input Common-mode Voltage Range)	VF7	ON	ON	OFF	15	-15	0	-15	5
	VF8				15	-15	0	13	
Power Supply Rejection Ratio	VF9	ON	ON	OFF	2	-2	0	0	6
	VF10				18	-18	0	0	

—Calculation—

1. Input Offset Voltage (Vio)

$$V_{io} = \frac{|VF1|}{1 + R_f / R_s} \text{ [V]}$$

2. Input Offset Current (Iio)

$$I_{io} = \frac{|VF2 - VF1|}{R_i \times (1 + R_f / R_s)} \text{ [A]}$$

3. Input Bias Current (Ib)

$$I_b = \frac{|VF4 - VF3|}{2 \times R_{ix} (1 + R_f / R_s)} \text{ [A]}$$

4. Large Signal Voltage Gain (Av)

$$A_v = 20 \times \text{Log} \frac{\Delta EK \times (1 + R_f / R_s)}{|VF5 - VF6|} \text{ [dB]}$$

5. Common-mode Rejection Ratio (CMRR)

$$CMRR = 20 \times \text{Log} \frac{\Delta V_{icm} \times (1 + R_f / R_s)}{|VF8 - VF7|} \text{ [dB]}$$

6. Power Supply Rejection Ratio (PSRR)

$$PSRR = 20 \times \text{Log} \frac{\Delta V_{cc} \times (1 + R_f / R_s)}{|VF10 - VF9|} \text{ [dB]}$$



Figure 48. Test circuit 1 (one channel only)

Switch Condition for Test Circuit 2

SW No.	SW 1	SW 2	SW 3	SW 4	SW 5	SW 6	SW 7	SW 8	SW 9	SW 10	SW 11	SW 12	SW 13	SW 14
Supply Current	OFF	OFF	OFF	ON	OFF	ON	OFF	OFF	OFF	OFF	OFF	OFF	OFF	OFF
Maximum Output Voltage(High)	OFF	OFF	ON	OFF	OFF	ON	OFF	OFF	ON	OFF	OFF	OFF	ON	OFF
Maximum Output Voltage(Low)	OFF	OFF	ON	OFF	OFF	ON	OFF	OFF	OFF	OFF	OFF	OFF	ON	OFF
Output Source Current	OFF	OFF	ON	OFF	OFF	ON	OFF	OFF	OFF	OFF	OFF	OFF	OFF	ON
Output Sink Current	OFF	OFF	ON	OFF	OFF	ON	OFF	OFF	OFF	OFF	OFF	OFF	OFF	ON
Slew Rate	OFF	OFF	OFF	ON	OFF	OFF	OFF	ON	ON	ON	OFF	OFF	OFF	OFF
Gain Bandwidth Product	OFF	ON	OFF	OFF	ON	ON	OFF	OFF	ON	ON	OFF	OFF	OFF	OFF
Equivalent Input Noise Voltage	ON	OFF	OFF	OFF	ON	ON	OFF	OFF	OFF	OFF	ON	OFF	OFF	OFF



Figure 49. Test circuit 2 (one channel only)

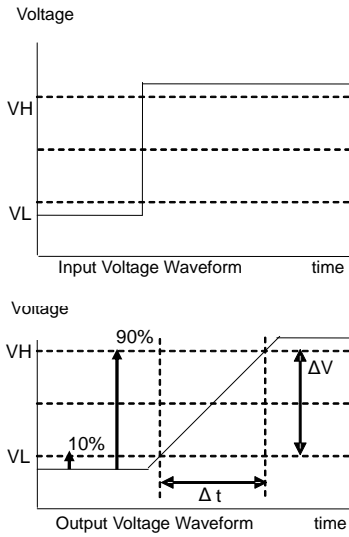

Figure 50. Slew rate input output wave

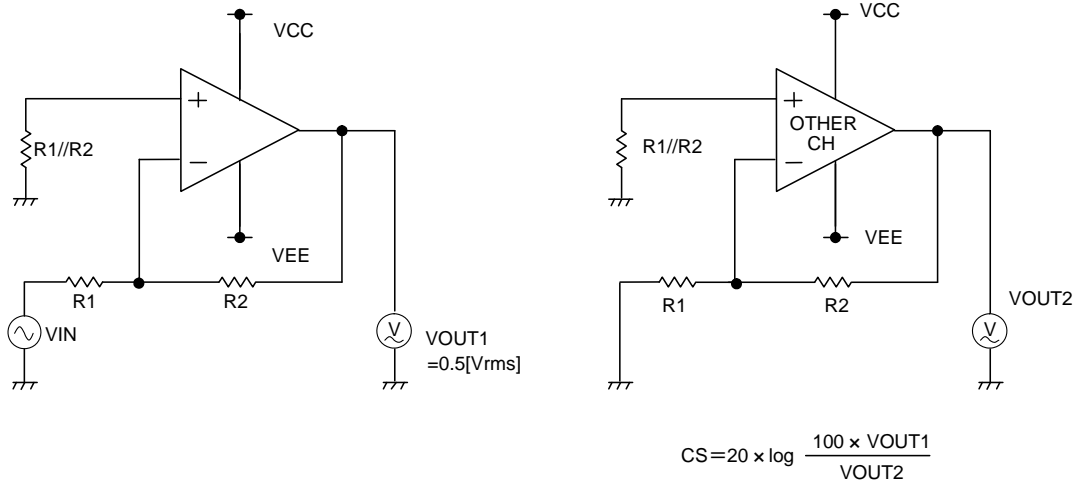

Figure 51. Test circuit 3 (Channel Separation)

● Power Dissipation

Power dissipation(total loss) indicates the power that can be consumed by IC at Ta=25°C(normal temperature). IC is heated when it consumed power, and the temperature of IC chip becomes higher than ambient temperature. The temperature that can be accepted by IC chip depends on circuit configuration, manufacturing process, and consumable power is limited. Power dissipation is determined by the temperature allowed in IC chip (maximum junction temperature) and thermal resistance of package (heat dissipation capability). The maximum junction temperature is typically equal to the maximum value in the storage temperature range. Heat generated by consumed power of IC radiates from the mold resin or lead frame of the package. The parameter which indicates this heat dissipation capability(hardness of heat release)is called thermal resistance, represented by the symbol θ_{ja} °C/W.The temperature of IC inside the package can be estimated by this thermal resistance. Figure 52. (a) shows the model of thermal resistance of the package. Thermal resistance θ_{ja} , ambient temperature Ta, maximum junction temperature Tjmax, and power dissipation Pd can be calculated by the equation below:

$$\theta_{ja} = (T_{jmax} - T_a) / P_d \quad \text{°C/W} \quad \dots \dots (I)$$

Derating curve in Figure 52. (b) indicates power that can be consumed by IC with reference to ambient temperature. Power that can be consumed by IC begins to attenuate at certain ambient temperature. This gradient is determined by thermal resistance θ_{ja} . Thermal resistance θ_{ja} depends on chip size, power consumption, package, ambient temperature, package condition, wind velocity, etc even when the same of package is used. Thermal reduction curve indicates a reference value measured at a specified condition. Figure 53. (c) ~ (f) shows a derating curve for an example of BA3472, BA3474, BA3472R, BA3474R.

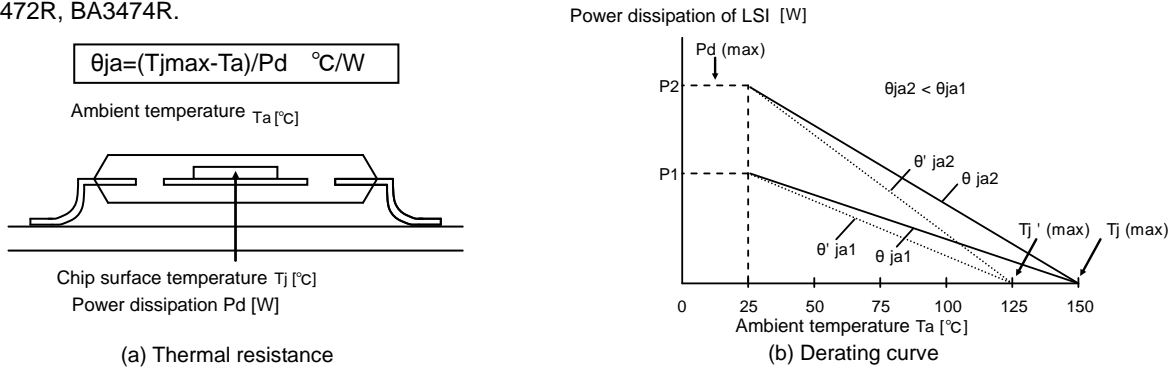
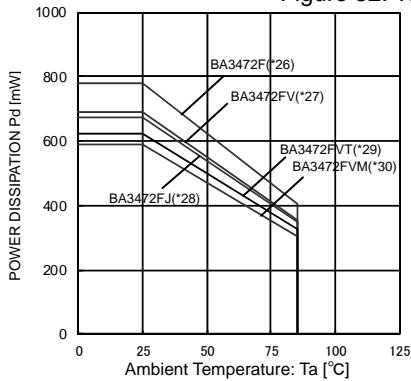
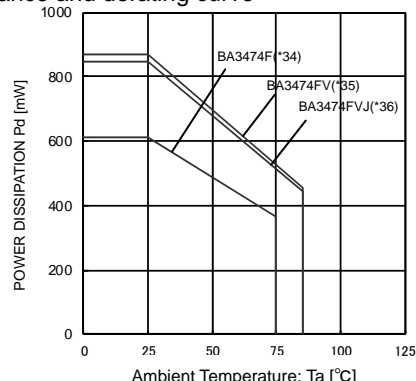

Figure 52. Thermal resistance and derating curve



(c)BA3472



(d)BA3474

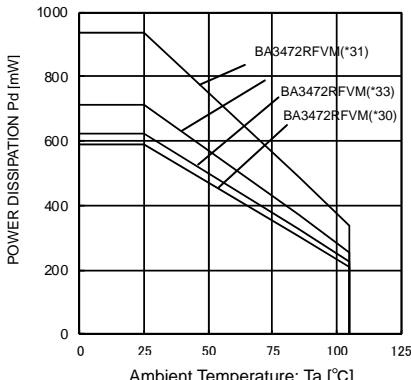

(e)BA3472R

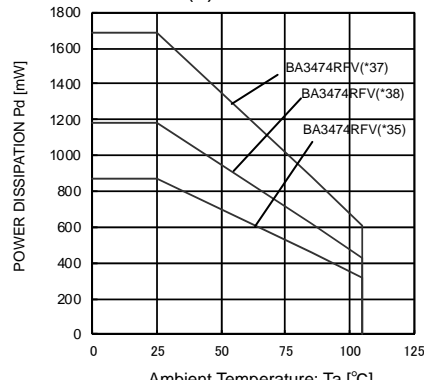

(f)BA3474R

(*26)	(*27)	(*28)	(*29)	(*30)	(*31)	(*32)	(*33)	(*34)	(*35)	(*36)	(*37)	(*38)	Unit
6.2	5.5	5.4	5.0	4.8	7.5	5.7	5.0	4.9	7.0	6.8	13.5	9.5	mW/°C

When using the unit above Ta=25°C, subtract the value above per degree°C.

(*26)(*27)(*28)(*29)(*30)(*34)(*35)(*36) Mounted on a FR4 glass epoxy 1 layers PCB 70mm × 70mm × 1.6mm (occupied copper area : below 3%).

(*33) Mounted on a FR4 glass epoxy 2 layers PCB 70mm × 70mm × 1.6mm (occupied copper area : 15mm × 15mm).

(*32) (*38) Mounted on a FR4 glass epoxy 2 layers PCB 70mm × 70mm × 1.6mm (occupied copper area : 70mm × 70mm).

(*31) (*37) Mounted on a FR4 glass epoxy 4 layers PCB 70mm × 70mm × 1.6mm (occupied copper area : 70mm × 70mm).

Figure 53. Derating curve

●Operational Notes

1) Unused circuits

When there are unused circuits it is recommended that they are connected as in Figure 54, setting the non-inverting input terminal to a potential within input common-mode voltage range (V_{icm}).

2) Input terminal voltage

Applying GND + 36V to the input terminal is possible without causing deterioration of the electrical characteristics or destruction, irrespective of the supply voltage. However, this does not ensure normal circuit operation. Please note that the circuit operates normally only when the input voltage is within the common mode input voltage range of the electric characteristics.

3) Power supply (single / dual)

The op-amp operates when the specified voltage supplied is between VCC and VEE. Therefore, the single supply op-amp can be used as dual supply op-amp as well.

4) Power dissipation P_d

Using the unit in excess of the rated power dissipation may cause deterioration in electrical characteristics due to a rise in chip temperature, including reduced current capability. Therefore, please take into consideration the power dissipation (P_d) under actual operating conditions and apply a sufficient margin in thermal design. Refer to the thermal derating curves for more information.

5) Short-circuit between pins and erroneous mounting

Incorrect mounting may damage the IC. In addition, the presence of foreign particles between the outputs, the output and the power supply, or the output and GND may result in IC destruction.

6) Operation in a strong electromagnetic field

Operation in a strong electromagnetic field may cause malfunctions.

7) Radiation

This IC is not designed to withstand radiation.

8) IC handling

Applying mechanical stress to the IC by deflecting or bending the board may cause fluctuations in the electrical characteristics due to piezo resistance effects.

9) Board inspection

Connecting a capacitor to a pin with low impedance may stress the IC. Therefore, discharging the capacitor after every process is recommended. In addition, when attaching and detaching the jig during the inspection phase, ensure that the power is turned OFF before inspection and removal. Furthermore, please take measures against ESD in the assembly process as well as during transportation and storage.

10) Output capacitor

Discharge of the external output capacitor to VCC is possible via internal parasitic elements when VCC is shorted to VEE, causing damage to the internal circuitry due to thermal stress. Therefore, when using this IC in circuits where oscillation due to output capacitive load does not occur, such as in voltage comparators, use an output capacitor with a capacitance less than 0.1 μ F.

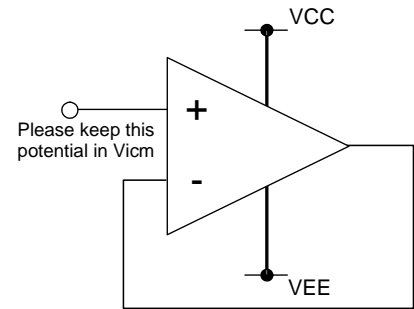

Figure 54. Unused circuit example

Status of this document

The Japanese version of this document is formal specification. A customer may use this translation version only for a reference to help reading the formal version.

If there are any differences in translation version of this document formal version takes priority.

●Physical Dimensions Tape and Reel Information

SOP8

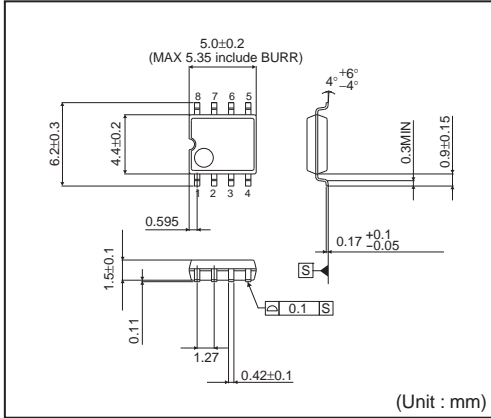

<Tape and Reel information>

Tape	Embossed carrier tape
Quantity	2500pcs
Direction of feed	E2 (The direction is the 1pin of product is at the upper left when you hold reel on the left hand and you pull out the tape on the right hand)

*Order quantity needs to be multiple of the minimum quantity.

SOP14

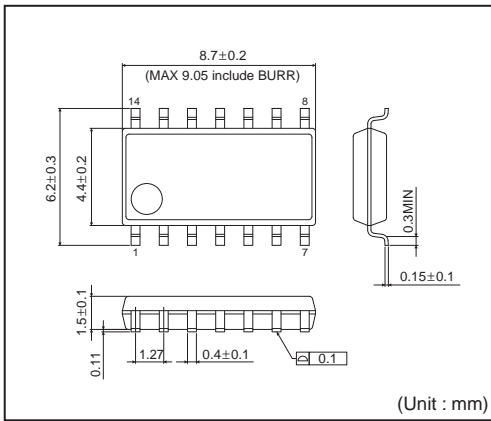

<Tape and Reel information>

Tape	Embossed carrier tape
Quantity	2500pcs
Direction of feed	E2 (The direction is the 1pin of product is at the upper left when you hold reel on the left hand and you pull out the tape on the right hand)

*Order quantity needs to be multiple of the minimum quantity.

SSOP-B8

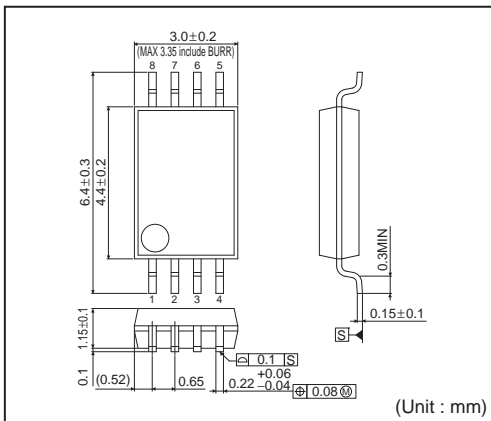

<Tape and Reel information>

Tape	Embossed carrier tape
Quantity	2500pcs
Direction of feed	E2 (The direction is the 1pin of product is at the upper left when you hold reel on the left hand and you pull out the tape on the right hand)

*Order quantity needs to be multiple of the minimum quantity.

SSOP-B14

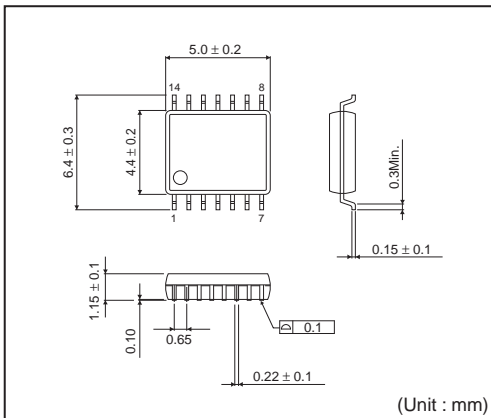

<Tape and Reel information>

Tape	Embossed carrier tape
Quantity	2500pcs
Direction of feed	E2 (The direction is the 1pin of product is at the upper left when you hold reel on the left hand and you pull out the tape on the right hand)

*Order quantity needs to be multiple of the minimum quantity.

TSSOP-B8

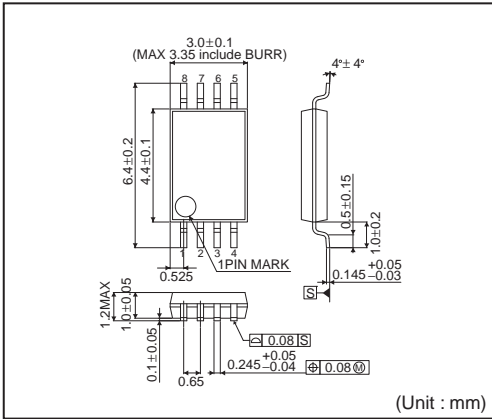

<Tape and Reel information>

Tape	Embossed carrier tape
Quantity	3000pcs
Direction of feed	E2 (The direction is the 1pin of product is at the upper left when you hold reel on the left hand and you pull out the tape on the right hand)



TSSOP-B14J

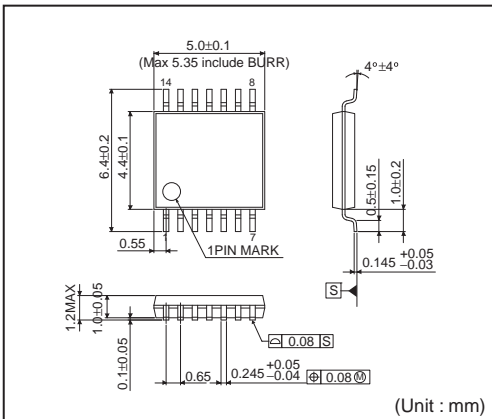

<Tape and Reel information>

Tape	Embossed carrier tape
Quantity	2500pcs
Direction of feed	E2 (The direction is the 1pin of product is at the upper left when you hold reel on the left hand and you pull out the tape on the right hand)

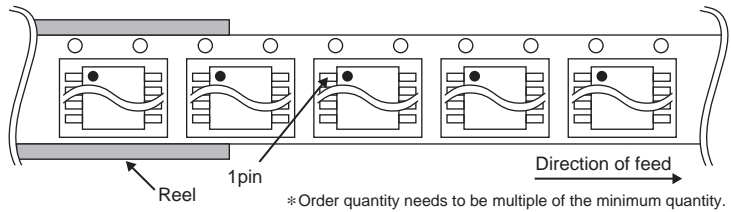

SOP-J8

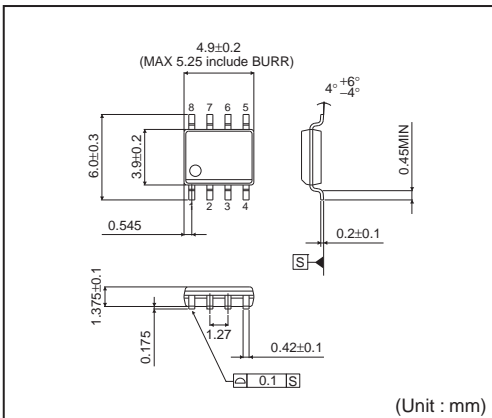

<Tape and Reel information>

Tape	Embossed carrier tape
Quantity	2500pcs
Direction of feed	E2 (The direction is the 1pin of product is at the upper left when you hold reel on the left hand and you pull out the tape on the right hand)

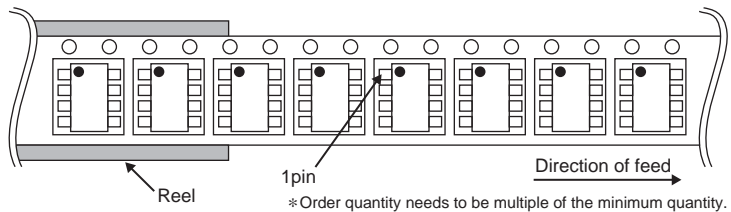

MSOP8

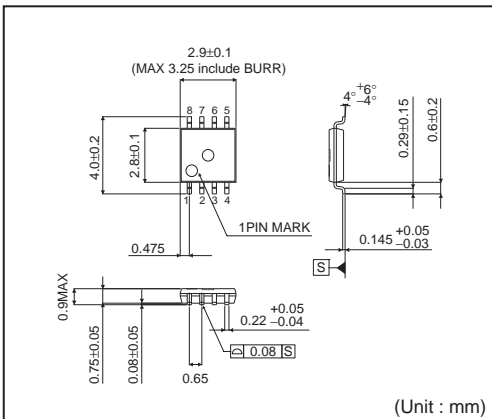

<Tape and Reel information>

Tape	Embossed carrier tape
Quantity	3000pcs
Direction of feed	TR (The direction is the 1pin of product is at the upper right when you hold reel on the left hand and you pull out the tape on the right hand)

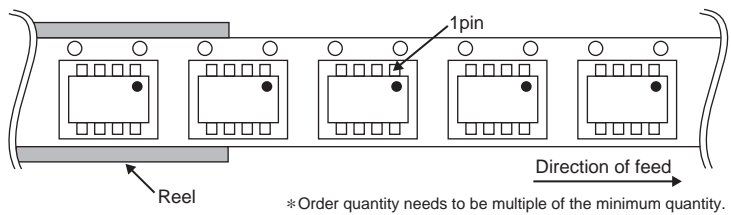

●Marking Diagrams

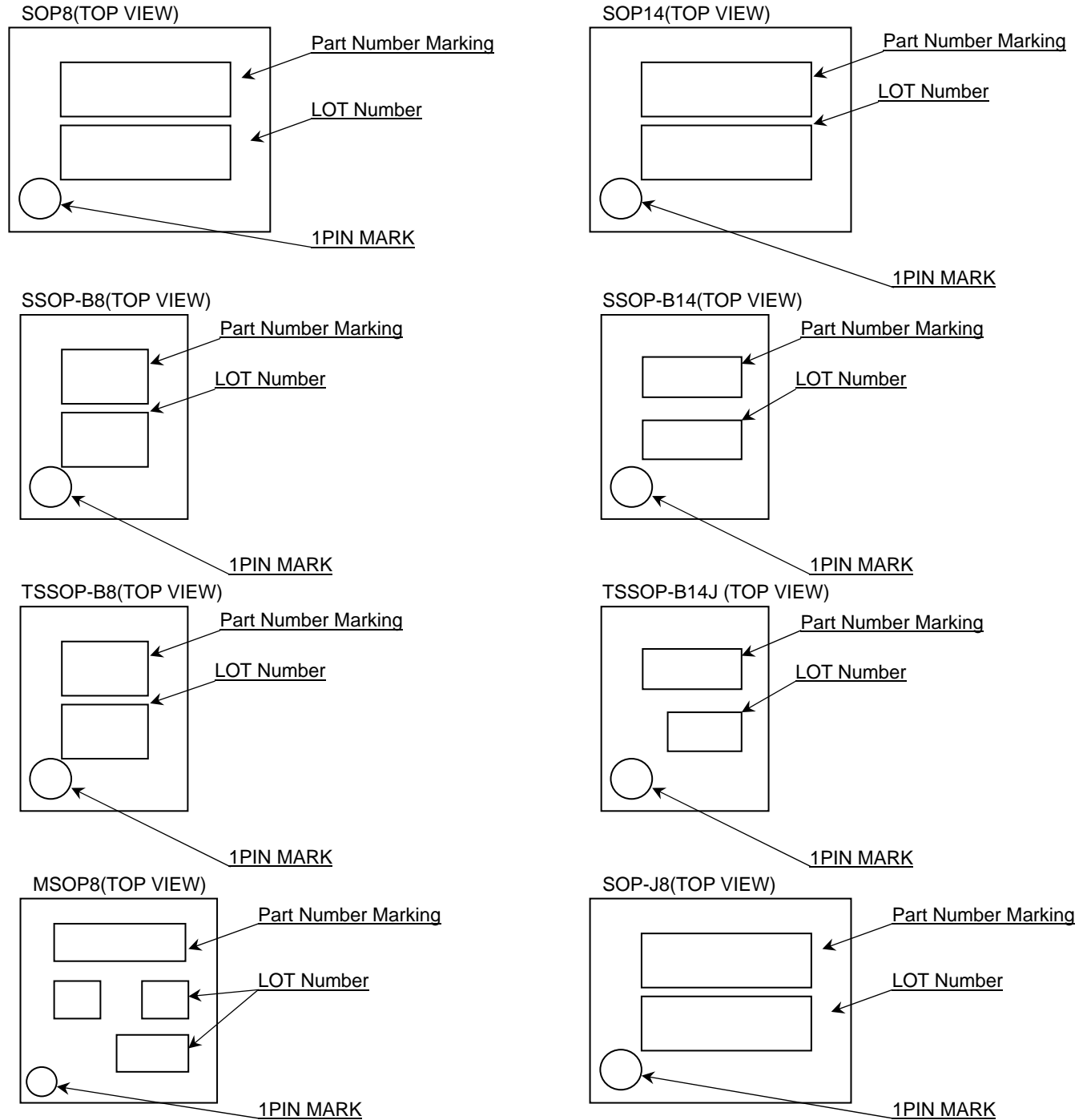

Product Name		Package Type	Marking
BA3472	F	SOP8	3472
	FV	SSOP-B8	
	FVM	MSOP8	
	FJ	SOP-J8	
	FVT	TSSOP-B8	
BA3472R	FVM	MSOP8	3472R
BA3474	F	SOP14	3474F
	FV	SSOP-B14	3474
	FVJ	TSSOP-B14J	
BA3474R	FV	SSOP-B14	3474R

●Land pattern data

all dimensions in mm

PKG	Land pitch e	Land space MIE	Land length $\geq l_2$	Land width b2
SOP8 SOP14	1.27	4.60	1.10	0.76
SOP-J8	1.27	3.90	1.35	0.76
SSOP-B8 SSOP-B14	0.65	4.60	1.20	0.35
MSOP8	0.65	2.62	0.99	0.35
TSSOP-B8	0.65	4.60	1.20	0.35
TSSOP-B14J	0.65	4.60	1.20	0.35

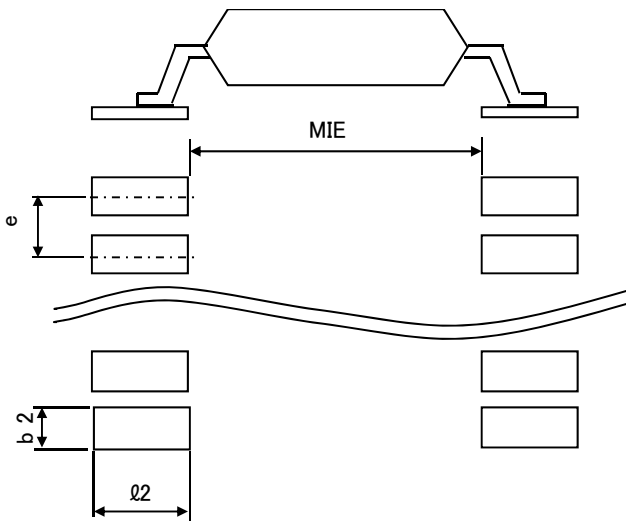

●Revision History

Date	Revision	Changes
27.Feb.2012	001	New Release
26.Oct.2012	002	add BA3472FJ, BA3472FVT, BA3474FVJ add Land pattern data

Notice

●General Precaution

- 1) Before you use our Products, you are requested to carefully read this document and fully understand its contents. ROHM shall not be in any way responsible or liable for failure, malfunction or accident arising from the use of any ROHM's Products against warning, caution or note contained in this document.
- 2) All information contained in this document is current as of the issuing date and subject to change without any prior notice. Before purchasing or using ROHM's Products, please confirm the latest information with a ROHM sales representative.

●Precaution on using ROHM Products

- 1) Our Products are designed and manufactured for application in ordinary electronic equipments (such as AV equipment, OA equipment, telecommunication equipment, home electronic appliances, amusement equipment, etc.). If you intend to use our Products in devices requiring extremely high reliability (such as medical equipment, transport equipment, traffic equipment, aircraft/spacecraft, nuclear power controllers, fuel controllers, car equipment including car accessories, safety devices, etc.) and whose malfunction or failure may cause loss of human life, bodily injury or serious damage to property ("Specific Applications"), please consult with the ROHM sales representative in advance. Unless otherwise agreed in writing by ROHM in advance, ROHM shall not be in any way responsible or liable for any damages, expenses or losses incurred by you or third parties arising from the use of any ROHM's Products for Specific Applications.
- 2) ROHM designs and manufactures its Products subject to strict quality control system. However, semiconductor products can fail or malfunction at a certain rate. Please be sure to implement, at your own responsibilities, adequate safety measures including but not limited to fail-safe design against the physical injury, damage to any property, which a failure or malfunction of our Products may cause. The following are examples of safety measures:
 - [a] Installation of protection circuits or other protective devices to improve system safety
 - [b] Installation of redundant circuits to reduce the impact of single or multiple circuit failure
- 3) Our Products are designed and manufactured for use under standard conditions and not under any special or extraordinary environments or conditions, as exemplified below. Accordingly, ROHM shall not be in any way responsible or liable for any damages, expenses or losses arising from the use of any ROHM's Products under any special or extraordinary environments or conditions. If you intend to use our Products under any special or extraordinary environments or conditions (as exemplified below), your independent verification and confirmation of product performance, reliability, etc. prior to use, must be necessary:
 - [a] Use of our Products in any types of liquid, including water, oils, chemicals, and organic solvents
 - [b] Use of our Products outdoors or in places where the Products are exposed to direct sunlight or dust
 - [c] Use of our Products in places where the Products are exposed to sea wind or corrosive gases, including Cl₂, H₂S, NH₃, SO₂, and NO₂
 - [d] Use of our Products in places where the Products are exposed to static electricity or electromagnetic waves
 - [e] Use of our Products in proximity to heat-producing components, plastic cords, or other flammable items
 - [f] Sealing or coating our Products with resin or other coating materials
 - [g] Use of our Products without cleaning residue of flux (even if you use no-clean type fluxes, cleaning residue of flux is recommended); or Washing our Products by using water or water-soluble cleaning agents for cleaning residue after soldering
 - [h] Use of the Products in places subject to dew condensation
- 4) The Products are not subject to radiation-proof design.
- 5) Please verify and confirm characteristics of the final or mounted products in using the Products.
- 6) In particular, if a transient load (a large amount of load applied in a short period of time, such as pulse) is applied, confirmation of performance characteristics after on-board mounting is strongly recommended. Avoid applying power exceeding normal rated power; exceeding the power rating under steady-state loading condition may negatively affect product performance and reliability.
- 7) De-rate Power Dissipation (Pd) depending on Ambient temperature (Ta). When used in sealed area, confirm the actual ambient temperature.
- 8) Confirm that operation temperature is within the specified range described in the product specification.
- 9) ROHM shall not be in any way responsible or liable for failure induced under deviant condition from what is defined in this document.

●Precaution for Mounting / Circuit board design

- 1) When a highly active halogenous (chlorine, bromine, etc.) flux is used, the residue of flux may negatively affect product performance and reliability.
- 2) In principle, the reflow soldering method must be used; if flow soldering method is preferred, please consult with the ROHM representative in advance.

For details, please refer to ROHM Mounting specification

●Precautions Regarding Application Examples and External Circuits

- 1) If change is made to the constant of an external circuit, please allow a sufficient margin considering variations of the characteristics of the Products and external components, including transient characteristics, as well as static characteristics.
- 2) You agree that application notes, reference designs, and associated data and information contained in this document are presented only as guidance for Products use. Therefore, in case you use such information, you are solely responsible for it and you must exercise your own independent verification and judgment in the use of such information contained in this document. ROHM shall not be in any way responsible or liable for any damages, expenses or losses incurred by you or third parties arising from the use of such information.

●Precaution for Electrostatic

This Product is electrostatic sensitive product, which may be damaged due to electrostatic discharge. Please take proper caution in your manufacturing process and storage so that voltage exceeding the Products maximum rating will not be applied to Products. Please take special care under dry condition (e.g. Grounding of human body / equipment / solder iron, isolation from charged objects, setting of Ionizer, friction prevention and temperature / humidity control).

●Precaution for Storage / Transportation

- 1) Product performance and soldered connections may deteriorate if the Products are stored in the places where:
 - [a] the Products are exposed to sea winds or corrosive gases, including Cl₂, H₂S, NH₃, SO₂, and NO₂
 - [b] the temperature or humidity exceeds those recommended by ROHM
 - [c] the Products are exposed to direct sunshine or condensation
 - [d] the Products are exposed to high Electrostatic
- 2) Even under ROHM recommended storage condition, solderability of products out of recommended storage time period may be degraded. It is strongly recommended to confirm solderability before using Products of which storage time is exceeding the recommended storage time period.
- 3) Store / transport cartons in the correct direction, which is indicated on a carton with a symbol. Otherwise bent leads may occur due to excessive stress applied when dropping of a carton.
- 4) Use Products within the specified time after opening a humidity barrier bag. Baking is required before using Products of which storage time is exceeding the recommended storage time period.

●Precaution for Product Label

QR code printed on ROHM Products label is for ROHM's internal use only.

●Precaution for Disposition

When disposing Products please dispose them properly using an authorized industry waste company.

●Precaution for Foreign Exchange and Foreign Trade act

Since our Products might fall under controlled goods prescribed by the applicable foreign exchange and foreign trade act, please consult with ROHM representative in case of export.

●Precaution Regarding Intellectual Property Rights

- 1) All information and data including but not limited to application example contained in this document is for reference only. ROHM does not warrant that foregoing information or data will not infringe any intellectual property rights or any other rights of any third party regarding such information or data. ROHM shall not be in any way responsible or liable for infringement of any intellectual property rights or other damages arising from use of such information or data.:
- 2) No license, expressly or implied, is granted hereby under any intellectual property rights or other rights of ROHM or any third parties with respect to the information contained in this document.

●Other Precaution

- 1) The information contained in this document is provided on an "as is" basis and ROHM does not warrant that all information contained in this document is accurate and/or error-free. ROHM shall not be in any way responsible or liable for any damages, expenses or losses incurred by you or third parties resulting from inaccuracy or errors of or concerning such information.
- 2) This document may not be reprinted or reproduced, in whole or in part, without prior written consent of ROHM.
- 3) The Products may not be disassembled, converted, modified, reproduced or otherwise changed without prior written consent of ROHM.
- 4) In no event shall you use in any way whatsoever the Products and the related technical information contained in the Products or this document for any military purposes, including but not limited to, the development of mass-destruction weapons.
- 5) The proper names of companies or products described in this document are trademarks or registered trademarks of ROHM, its affiliated companies or third parties.

Компания «Океан Электроники» предлагает заключение долгосрочных отношений при поставках импортных электронных компонентов на взаимовыгодных условиях!

Наши преимущества:

- Поставка оригинальных импортных электронных компонентов напрямую с производств Америки, Европы и Азии, а так же с крупнейших складов мира;
- Широкая линейка поставок активных и пассивных импортных электронных компонентов (более 30 млн. наименований);
- Поставка сложных, дефицитных, либо снятых с производства позиций;
- Оперативные сроки поставки под заказ (от 5 рабочих дней);
- Экспресс доставка в любую точку России;
- Помощь Конструкторского Отдела и консультации квалифицированных инженеров;
- Техническая поддержка проекта, помощь в подборе аналогов, поставка прототипов;
- Поставка электронных компонентов под контролем ВП;
- Система менеджмента качества сертифицирована по Международному стандарту ISO 9001;
- При необходимости вся продукция военного и аэрокосмического назначения проходит испытания и сертификацию в лаборатории (по согласованию с заказчиком);
- Поставка специализированных компонентов военного и аэрокосмического уровня качества (Xilinx, Altera, Analog Devices, Intersil, Interpoint, Microsemi, Actel, Aeroflex, Peregrine, VPT, Syfer, Eurofarad, Texas Instruments, MS Kennedy, Miteq, Cobham, E2V, MA-COM, Hittite, Mini-Circuits, General Dynamics и др.);

Компания «Океан Электроники» является официальным дистрибьютором и эксклюзивным представителем в России одного из крупнейших производителей разъемов военного и аэрокосмического назначения «JONHON», а так же официальным дистрибьютором и эксклюзивным представителем в России производителя высокотехнологичных и надежных решений для передачи СВЧ сигналов «FORSTAR».



JONHON

«JONHON» (основан в 1970 г.)

Разъемы специального, военного и аэрокосмического назначения:

(Применяются в военной, авиационной, аэрокосмической, морской, железнодорожной, горно- и нефтедобывающей отраслях промышленности)

«FORSTAR» (основан в 1998 г.)

ВЧ соединители, коаксиальные кабели,
кабельные сборки и микроволновые компоненты:

(Применяются в телекоммуникациях гражданского и специального назначения, в средствах связи, РЛС, а так же военной, авиационной и аэрокосмической отраслях промышленности).



Телефон: 8 (812) 309-75-97 (многоканальный)

Факс: 8 (812) 320-03-32

Электронная почта: ocean@oceanchips.ru

Web: <http://oceanchips.ru/>

Адрес: 198099, г. Санкт-Петербург, ул. Калинина, д. 2, корп. 4, лит. А