



Is Now Part of



**ON Semiconductor®**

To learn more about ON Semiconductor, please visit our website at  
[www.onsemi.com](http://www.onsemi.com)

Please note: As part of the Fairchild Semiconductor integration, some of the Fairchild orderable part numbers will need to change in order to meet ON Semiconductor's system requirements. Since the ON Semiconductor product management systems do not have the ability to manage part nomenclature that utilizes an underscore (\_), the underscore (\_) in the Fairchild part numbers will be changed to a dash (-). This document may contain device numbers with an underscore (\_). Please check the ON Semiconductor website to verify the updated device numbers. The most current and up-to-date ordering information can be found at [www.onsemi.com](http://www.onsemi.com). Please email any questions regarding the system integration to [Fairchild\\_questions@onsemi.com](mailto:Fairchild_questions@onsemi.com).

ON Semiconductor and the ON Semiconductor logo are trademarks of Semiconductor Components Industries, LLC dba ON Semiconductor or its subsidiaries in the United States and/or other countries. ON Semiconductor owns the rights to a number of patents, trademarks, copyrights, trade secrets, and other intellectual property. A listing of ON Semiconductor's product/patent coverage may be accessed at [www.onsemi.com/site/pdf/Patent-Marking.pdf](http://www.onsemi.com/site/pdf/Patent-Marking.pdf). ON Semiconductor reserves the right to make changes without further notice to any products herein. ON Semiconductor makes no warranty, representation or guarantee regarding the suitability of its products for any particular purpose, nor does ON Semiconductor assume any liability arising out of the application or use of any product or circuit, and specifically disclaims any and all liability, including without limitation special, consequential or incidental damages. Buyer is responsible for its products and applications using ON Semiconductor products, including compliance with all laws, regulations and safety requirements or standards, regardless of any support or applications information provided by ON Semiconductor. "Typical" parameters which may be provided in ON Semiconductor data sheets and/or specifications can and do vary in different applications and actual performance may vary over time. All operating parameters, including "Typicals" must be validated for each customer application by customer's technical experts. ON Semiconductor does not convey any license under its patent rights nor the rights of others. ON Semiconductor products are not designed, intended, or authorized for use as a critical component in life support systems or any FDA Class 3 medical devices or medical devices with a same or similar classification in a foreign jurisdiction or any devices intended for implantation in the human body. Should Buyer purchase or use ON Semiconductor products for any such unintended or unauthorized application, Buyer shall indemnify and hold ON Semiconductor and its officers, employees, subsidiaries, affiliates, and distributors harmless against all claims, costs, damages, and expenses, and reasonable attorney fees arising out of, directly or indirectly, any claim of personal injury or death associated with such unintended or unauthorized use, even if such claim alleges that ON Semiconductor was negligent regarding the design or manufacture of the part. ON Semiconductor is an Equal Opportunity/Affirmative Action Employer. This literature is subject to all applicable copyright laws and is not for resale in any manner.



June 2015



# FAN48630 — 2.5 MHz, 1500 mA, Synchronous TinyBoost® Regulator with Bypass Mode

## Features

- Few External Components: 0.47  $\mu$ H Inductor and 0603 Case Size Input and Output Capacitors
- Input Voltage Range: 2.35 V to 5.5 V
- Fixed Output Voltage Options: 3.0 V to 5.0 V
- Maximum Continuous Load Current: 1500 mA at  $V_{IN}$  of 2.6 V Boosting  $V_{OUT}$  to 3.5 V
- Up to 96% Efficient
- True Bypass Operation when  $V_{IN} > V_{OUT\_TARGET}$
- Internal Synchronous Rectifier
- Soft-Start with True Load Disconnect
- Forced Bypass Mode
- $V_{SEL}$  Control to Optimize Target  $V_{OUT}$
- Short-Circuit Protection
- Low Operating Quiescent Current
- 16-Bump, 0.4 mm Pitch WLCSP

## Applications

- Boost for Low-Voltage Li-ion Batteries, Brownout Prevention, Boosted Audio, USB OTG, and LTE / 3G RF Power
- Cell Phones, Smart Phones, Portable Instruments

## Description

The FAN48630 allows systems to take advantage of new battery chemistries that can supply significant energy when the battery voltage is lower than the required voltage for system power ICs. By combining built-in power transistors, synchronous rectification, and low supply current; this IC provides a compact solution for systems using advanced Li-Ion battery chemistries.

The FAN48630 is a boost regulator designed to provide a minimum output voltage from a single-cell Li-Ion battery, even when the battery voltage is below system minimum. Output voltage regulation is guaranteed to a maximum load current of 1500 mA. Quiescent current in Shutdown Mode is less than 3  $\mu$ A, which maximizes battery life. The regulator transitions smoothly between Bypass and normal Boost Mode. The device can be forced into Bypass Mode to reduce quiescent current.

The FAN48630 is available in a 16-bump, 0.4 mm pitch, Wafer-Level Chip-Scale Package (WLCSP).

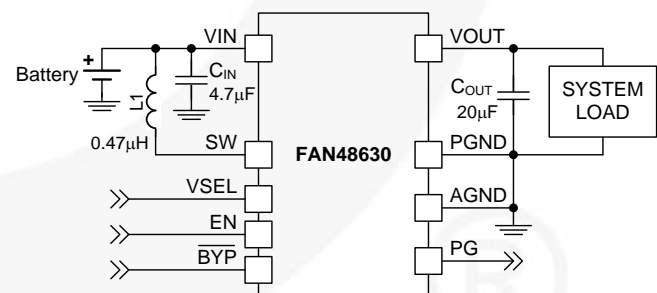

Figure 1. Typical Application

## Ordering Information

Part Number	Output Voltage <sup>(1)</sup> V <sub>SEL0</sub> / V <sub>SEL1</sub>	Soft-Start	Forced Bypass	Operating Temperature	Package	Packing
FAN48630UC315X	3.15 / 3.33	FAST	Low I <sub>Q</sub>	-40°C to 85°C	16-Ball, 4x4 Array, 0.4 mm Pitch, 250 μm Ball, Wafer-Level Chip-Scale Package (WLCSP)	Tape and Reel
FAN48630BUC315X <sup>(2)</sup>	3.15 / 3.33	FAST	Low I <sub>Q</sub>			
FAN48630UC33X	3.30 / 3.49	FAST	Low I <sub>Q</sub>			
FAN48630BUC34X <sup>(2)</sup>	3.20 / 3.40	FAST	Low I <sub>Q</sub>			
FAN48630UC35X	3.50 / 3.70	FAST	Low I <sub>Q</sub>			
FAN48630UC37AX	3.70 / 3.77	FAST	Low I <sub>Q</sub>			
FAN48630UC45X	4.50 / 4.76	SLOW	OCP On			
FAN48630UC50X	5.00 / 5.29	SLOW	OCP On			

### Notes:

- Other output voltages are available on request. Please contact a Fairchild Semiconductor representative.
- The FAN48630BUC315X and FAN48630BUC34X include backside lamination.

## Typical Application

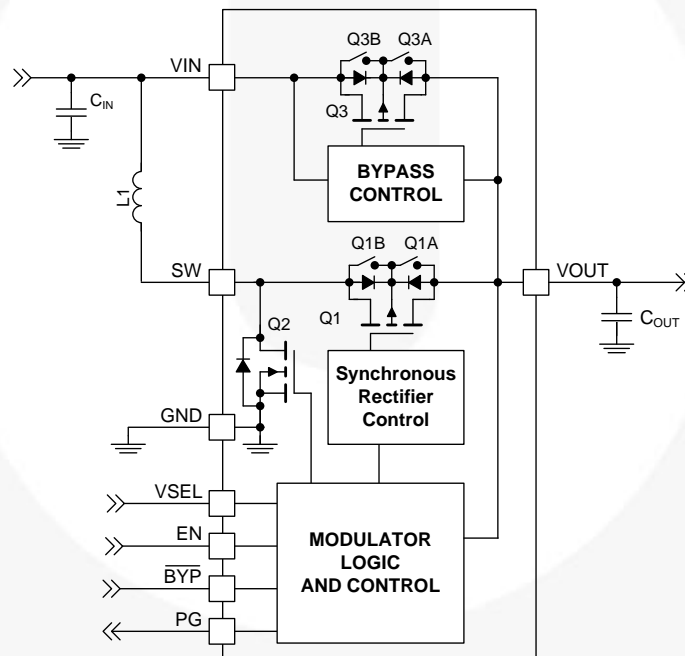

Figure 2. Block Diagram

Table 1. Recommended Components

Component	Description	Vendor	Parameter	Typ.	Unit
L1	0.47 μH, 30%	Toko: DFE201612C DFR201612C Cyntec: PIFE20161B	L	0.47	μH
			DCR (Series R)	40	mΩ
C <sub>IN</sub>	4.7 μF, 10%, 6.3 V, X5R, 0603	Murata: GRM188R60J475K TDK: C1608X5R0J475K	C	4.7	μF
C <sub>OUT</sub>	2 x 10 μF, 20%, 10 V, X5R, 0603	TDK: C1608X5R1A106M	C	20	μF

## Pin Configuration

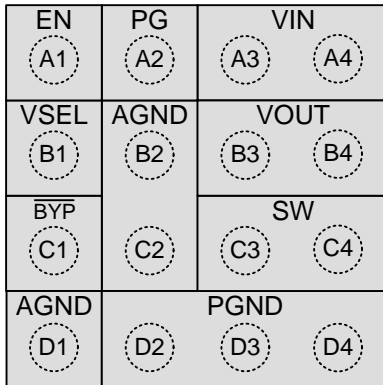

Figure 3. Top Through View (Bumps Down)

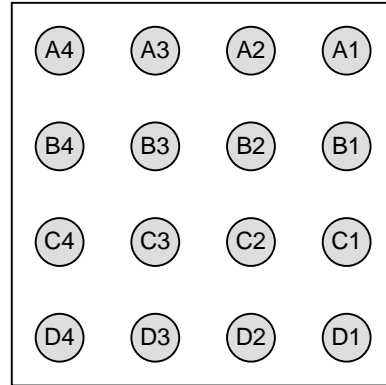

Figure 4. Bottom View (Bumps Up)

## Pin Definitions

Pin #	Name	Description
A1	EN	<b>Enable.</b> When this pin is HIGH, the circuit is enabled. <sup>(3)</sup>
A2	PG	<b>Power Good.</b> This is an open-drain output. PG is actively pulled LOW if output falls out of regulation due to overload or if thermal protection threshold is exceeded.
A3–A4	VIN	<b>Input Voltage.</b> Connect to Li-Ion battery input power source. <sup>(3)</sup>
B1	VSEL	<b>Output Voltage Select.</b> When boost is running, this pin can be used to select output voltage.
B2, C2 D1	AGND	<b>Analog Ground.</b> This is the signal ground reference for the IC. All voltage levels are measured with respect to this pin.
B3–B4	VOUT	<b>Output Voltage.</b> Place C <sub>OUT</sub> as close as possible to the device.
C1	$\overline{\text{BYP}}$	<b>Bypass.</b> This pin can be used to activate Forced Bypass Mode. When this pin is LOW, the bypass switches (Q3 and Q1) are turned on and the IC is otherwise inactive.
C3–C4	SW	<b>Switching Node.</b> Connect to inductor.
D2–D4	PGND	<b>Power Ground.</b> This is the power return for the IC. The C <sub>OUT</sub> bypass capacitor should be returned with the shortest path possible to these pins.

**Note:**

- Do not connect the EN pin to VIN. A logic voltage of 1.8 V should control the EN pin and enable / disable the device.

## Absolute Maximum Ratings

Stresses exceeding the absolute maximum ratings may damage the device. The device may not function or be operable above the recommended operating conditions and stressing the parts to these levels is not recommended. In addition, extended exposure to stresses above the recommended operating conditions may affect device reliability. The absolute maximum ratings are stress ratings only.

Symbol	Parameter		Min.	Max.	Unit
$V_{IN}$	$V_{IN}$ Input Voltage		-0.3	6.5	V
$V_{OUT}$	$V_{OUT}$ Output Voltage			6.0	V
	SW Node	DC	-0.3	8.0	V
		Transient: 10 ns, 3 MHz	-1.0	8.0	V
	Other Pins		-0.3	6.5 <sup>(4)</sup>	V
ESD	Electrostatic Discharge Protection Level	Human Body Model per JESD22-A114	3.0		kV
		Charged Device Model per JESD22-C101	1.5		kV
$T_J$	Junction Temperature		-40	+150	°C
$T_{STG}$	Storage Temperature		-65	+150	°C
$T_L$	Lead Soldering Temperature, 10 Seconds			+260	°C

### Note:

4. Lesser of 6.5 V or  $V_{IN} + 0.3$  V.

## Recommended Operating Conditions

The Recommended Operating Conditions table defines the conditions for actual device operation. Recommended operating conditions are specified to ensure optimal performance to the datasheet specifications. Fairchild does not recommend exceeding them or designing to absolute maximum ratings.

Symbol	Parameter	Min.	Max.	Unit
$V_{IN}$	Supply Voltage	2.35	5.50	V
$I_{OUT}$	Output Current	0	1500	mA
$T_A$	Ambient Temperature	-40	+85	°C
$T_J$	Junction Temperature	-40	+125	°C

## Thermal Properties

Junction-to-ambient thermal resistance is a function of application and board layout. This data is measured with four-layer Fairchild evaluation boards (1 oz copper on all layers). Special attention must be paid not to exceed junction temperature  $T_{J(max)}$  at a given ambient temperature  $T_A$ .

Symbol	Parameter	Typical	Unit
$\theta_{JA}$	Junction-to-Ambient Thermal Resistance	80	°C/W
$\theta_{JB}$	Junction-to-Board Thermal Resistance	42	

## Electrical Specifications

Recommended operating conditions, unless otherwise noted, circuit per Figure 1,  $V_{IN} = 2.35\text{ V}$  to  $V_{OUT}$ ,  $T_A = -40^\circ\text{C}$  to  $85^\circ\text{C}$ . Typical values are given  $V_{IN} = 3.0\text{ V}$  and  $T_A = 25^\circ\text{C}$ .

Symbol	Parameter	Conditions	Min.	Typ.	Max.	Unit
$I_Q$	$V_{IN}$ Quiescent Current	Bypass Mode $V_{OUT}=3.5\text{ V}$ , $V_{IN}=4.2\text{ V}$		140	190	$\mu\text{A}$
		Boost Mode $V_{OUT}=3.5\text{ V}$ , $V_{IN}=2.5\text{ V}$		150	250	$\mu\text{A}$
		Shutdown: $\text{EN}=0$ , $V_{IN}=3.0\text{ V}$		1.5	5.0	$\mu\text{A}$
		Forced Bypass Mode $V_{OUT}=3.5\text{ V}$ , $V_{IN}=3.5\text{ V}$	Low $I_Q$		4	10
OCP On			45	90	$\mu\text{A}$	
$I_{LK}$	$V_{OUT}$ to $V_{IN}$ Reverse Leakage	$V_{OUT}=5\text{ V}$ , $\text{EN}=0$		0.2	1.0	$\mu\text{A}$
$I_{LK\_OUT}$	$V_{OUT}$ Leakage Current	$V_{OUT}=0$ , $\text{EN}=0$ , $V_{IN}=4.2\text{ V}$		0.1	1.0	$\mu\text{A}$
$V_{UVLO}$	Under-Voltage Lockout	$V_{IN}$ Rising		2.20	2.35	V
$V_{UVLO\_HYS}$	Under-Voltage Lockout Hysteresis			200		mV
$V_{PG(OL)}$	PG Low	$I_{PG}=5\text{ mA}$			0.4	V
$I_{PG\_LK}$	PG Leakage Current	$V_{PG}=5\text{ V}$			1	$\mu\text{A}$
$V_{IH}$	Logic Level High $\text{EN}$ , $\text{VSEL}$ , $\text{BYP}$		1.2			V
$V_{IL}$	Logic Level Low $\text{EN}$ , $\text{VSEL}$ , $\text{BYP}$				0.4	V
$R_{LOW}$	Logic Control Pin Pull Downs (LOW Active)	$\text{BYP}$ , $\text{VSEL}$ , $\text{EN}$		300		$\text{k}\Omega$
$I_{PD}$	Weak Current Source Pull-Down	$\text{BYP}$ , $\text{VSEL}$ , $\text{EN}$		100		nA
$V_{REG}$	Output Voltage Accuracy	Referred to GND, DC, $V_{OUT}-V_{IN} > 100\text{ mV}$	-2		4	%
$V_{TRSP}$	Load Transient Response	500 – 1250 mA, $V_{IN}=3.6\text{ V}$ , $V_{OUT}=5.0\text{ V}$		$\pm 4$		%
$t_{ON}$	On-Time	$V_{IN}=3.0\text{ V}$ , $V_{OUT}=3.5\text{ V}$ , Load $> 1000\text{ mA}$		80		ns
$f_{SW}$	Switching Frequency	$V_{IN}=3.6\text{ V}$ , $V_{OUT}=5.0\text{ V}$ , Load $= 1000\text{ mA}$	2.0	2.5	3.0	MHz
$I_{V\_LIM}$	Boost Valley Current Limit	$V_{IN}=2.6\text{ V}$	2.6	2.9	3.1	A
$I_{V\_LIM\_SS}$	Boost Valley Current Limit During SS	$V_{IN}=2.6\text{ V}$		1.6		A
$V_{MIN\_1.5A}$	Minimum $V_{IN}$ for 1500 mA Load (Short Term)	$V_{OUT}=5.0\text{ V}$ , $T_J < 120^\circ\text{C}$		3.0		V
		$V_{OUT}=4.5\text{ V}$ , $T_J < 120^\circ\text{C}$		2.8		V
		$V_{OUT}=3.5\text{ V}$ , $T_J < 120^\circ\text{C}$		2.35		V
		$V_{OUT}=3.15\text{ V}$ , $T_J < 120^\circ\text{C}$		2.35		V
$I_{SS\_PK}$	Soft-Start Input Peak Current Limit	LIN1	Slow		350	mA
			Fast		800	mA
		LIN2	Slow		700	mA
			Fast		1600	mA
$t_{SS}$	Soft-Start EN HIGH to Regulation	Slow, $50\ \Omega$ Load		1300		$\mu\text{s}$
		Fast, $50\ \Omega$ Load		600		$\mu\text{s}$
$V_{OCP}$	OCP Comparator Threshold	$V_{IN}=5.0\text{ V}$ , $V_{IN}-V_{OUT}$		200		mV
$V_{OVP}$	Output Over-Voltage Protection Threshold			6.0	6.3	V
$V_{OVP\_HYS}$	Output Over-Voltage Protection Hysteresis			300		mV

Continued on the following page...

**Electrical Specifications** (Continued)

Recommended operating conditions, unless otherwise noted, circuit per Figure 1,  $V_{IN} = 2.35\text{ V}$  to  $V_{OUT}$ ,  $T_A = -40^\circ\text{C}$  to  $85^\circ\text{C}$ . Typical values are given  $V_{IN} = 3.0\text{ V}$  and  $T_A = 25^\circ\text{C}$ .

Symbol	Parameter	Conditions	Min.	Typ.	Max.	Unit
$R_{DS(ON)N}$	N-Channel Boost Switch $R_{DS(ON)}$	$V_{IN}=3.5\text{ V}$ , $V_{OUT}=3.5\text{ V}$		85	120	m $\Omega$
$R_{DS(ON)P}$	P-Channel Sync Rectifier $R_{DS(ON)}$	$V_{IN}=3.5\text{ V}$ , $V_{OUT}=3.5\text{ V}$		65	85	m $\Omega$
$R_{DS(ON)P\_BYP}$	P-Channel Bypass Switch $R_{DS(ON)}$	$V_{IN}=3.5\text{ V}$ , $V_{OUT}=3.5\text{ V}$		65	85	m $\Omega$
$T_{120A}$	T120 Activation Threshold			120		$^\circ\text{C}$
$T_{120R}$	T120 Release Threshold			100		$^\circ\text{C}$
$T_{150T}$	T150 Threshold			150		$^\circ\text{C}$
$T_{150H}$	T150 Hysteresis			20		$^\circ\text{C}$
$t_{RST}$	FAULT Restart Timer			20		ms

## Typical Characteristics

Unless otherwise specified;  $V_{IN} = 3.6\text{ V}$ , and  $V_{OUT} = 5\text{ V}$ , and  $T_A = 25^\circ\text{C}$ ; circuit and components according to Figure 1.

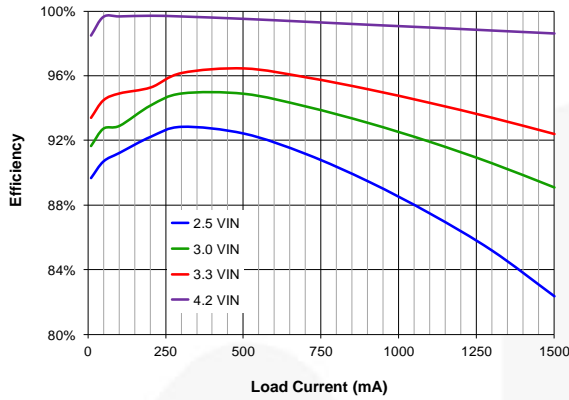

Figure 5. Efficiency vs. Load Current and Input Voltage,  $V_{OUT}=3.5\text{ V}$

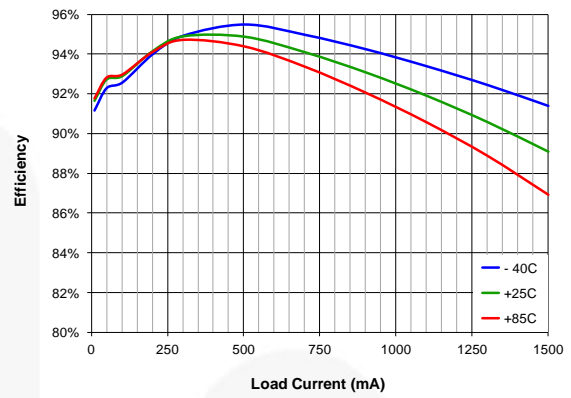

Figure 6. Efficiency vs. Load Current and Temperature,  $V_{IN}=3.0\text{ V}$ ,  $V_{OUT}=3.5\text{ V}$

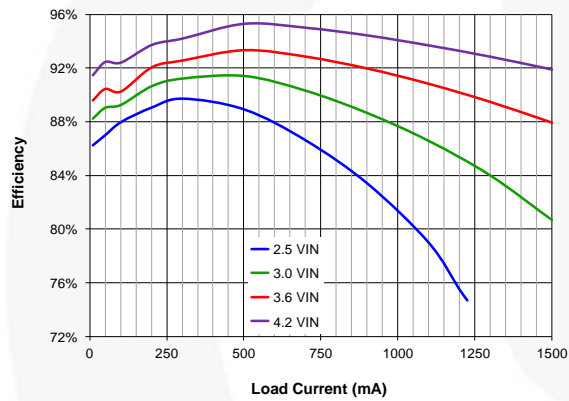

Figure 7. Efficiency vs. Load Current and Input Voltage

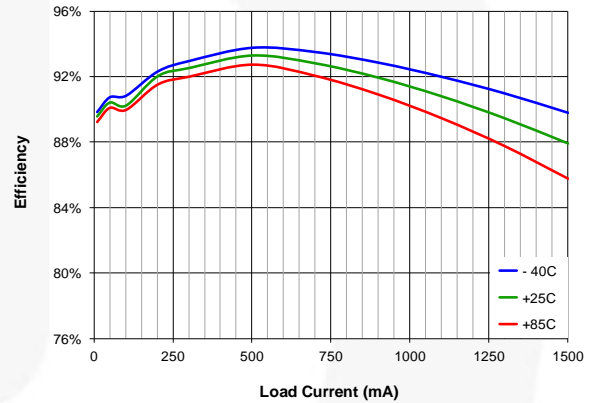

Figure 8. Efficiency vs. Load Current and Temperature

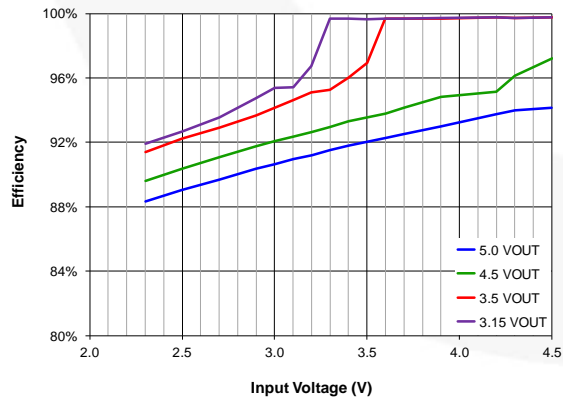

Figure 9. Efficiency vs. Input Voltage and Output Voltage, 200 mA Load

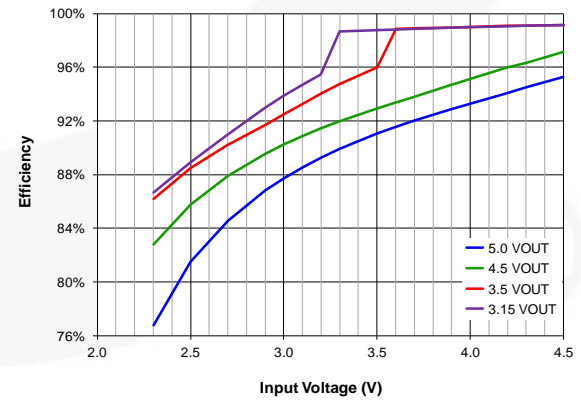
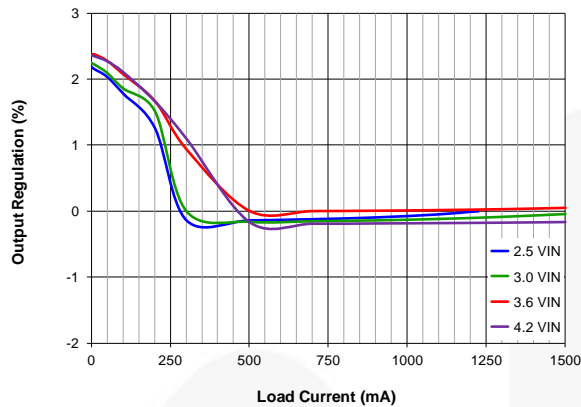

Figure 10. Efficiency vs. Input Voltage and Output Voltage, 1000 mA Load



## Typical Characteristics (Continued)

Unless otherwise specified;  $V_{IN} = 3.6\text{ V}$ ,  $V_{OUT} = 5\text{ V}$ , and  $T_A = 25^\circ\text{C}$ ; circuit and components according to Figure 1.



**Figure 11. Output Regulation vs. Load Current and Input Voltage (Normalized to 3.6  $V_{IN}$ , 500 mA Load)**

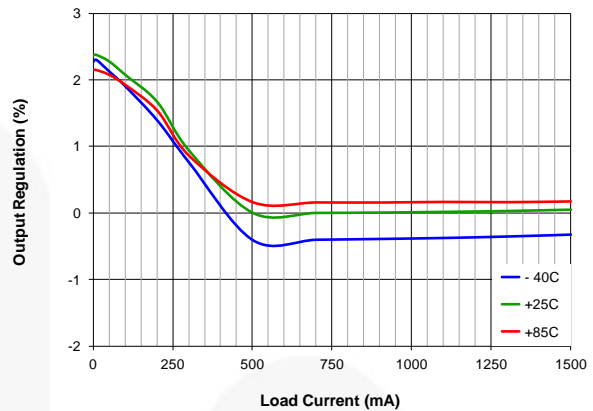

**Figure 12. Output Regulation vs. Load Current and Temperature (Normalized to 3.6  $V_{IN}$ , 500 mA Load,  $T_A=25^\circ\text{C}$ )**

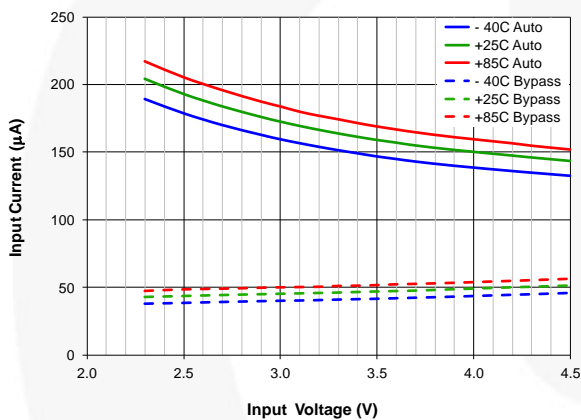

**Figure 13. Quiescent Current vs. Input Voltage, Temperature and Mode,  $V_{OUT}=5.0\text{ V}$ , Forced Bypass, OCP Active**

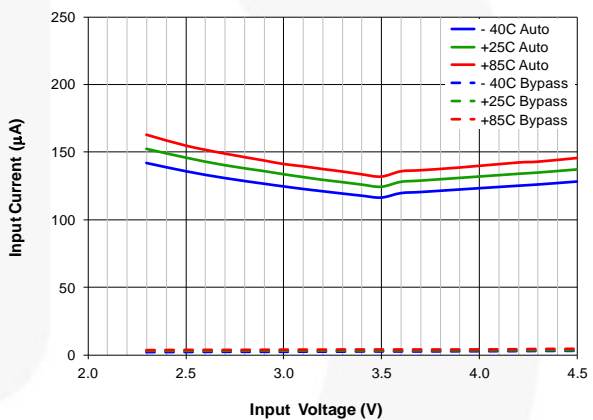

**Figure 14. Quiescent Current vs. Input Voltage, Temperature and Mode,  $V_{OUT}=3.5\text{ V}$ , Forced Bypass, Low  $I_Q$**

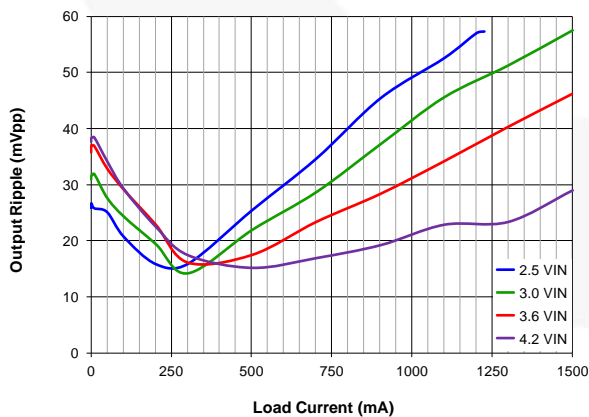

**Figure 15. Output Ripple vs. Load Current and Input Voltage**

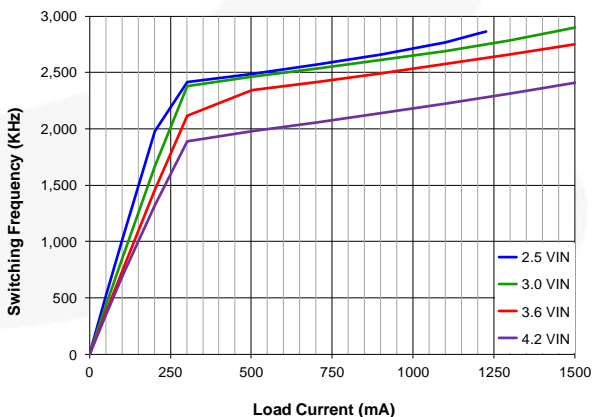

**Figure 16. Frequency vs. Load Current and Input Voltage**

## Typical Characteristics (Continued)

Unless otherwise specified,  $V_{IN} = 3.6\text{ V}$ ;  $V_{OUT} = 5\text{ V}$ , and  $T_A = 25^\circ\text{C}$ ; circuit and components according to Figure 1.

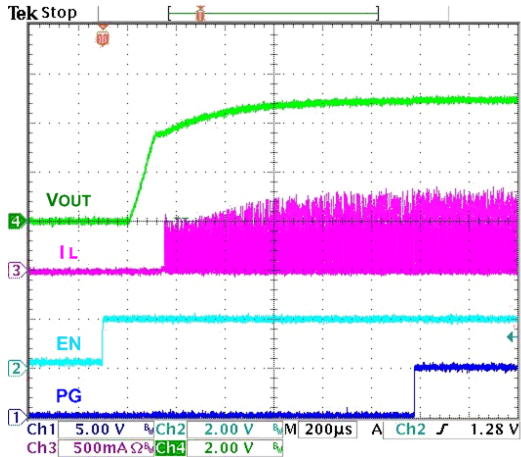

Figure 17. Startup, 50  $\Omega$  Load

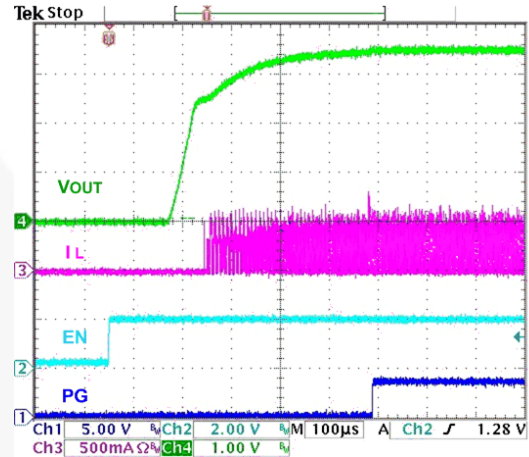

Figure 18. Startup, 50  $\Omega$  Load,  $V_{IN}=2.5\text{ V}$ ,  $V_{OUT}=3.5\text{ V}$

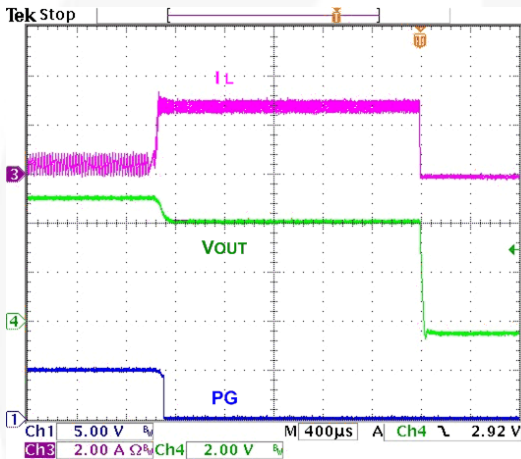

Figure 19. Overload Protection

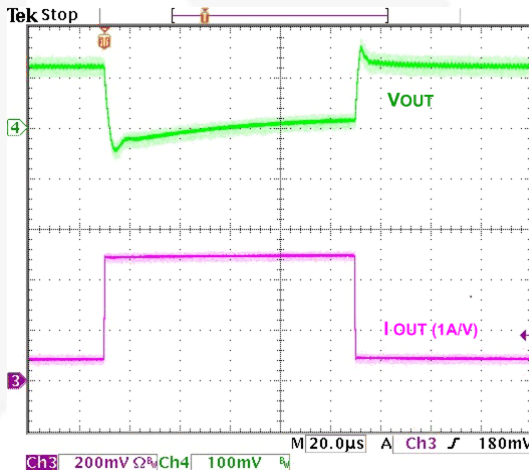

Figure 20. Load Transient, 100-500 mA, 100 ns Edge

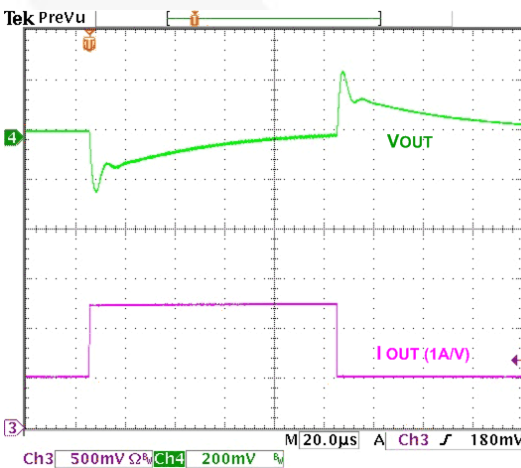

Figure 21. Load Transient, 500-1250 mA, 100 ns Edge

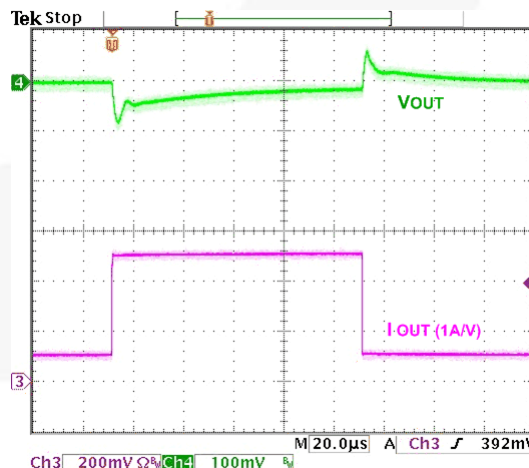

Figure 22. Load Transient, 100-500 mA, 100 ns Edge,  $V_{IN}=3\text{ V}$ ,  $V_{OUT}=3.5\text{ V}$

### Typical Characteristics (Continued)

Unless otherwise specified,  $V_{IN} = 3.6\text{ V}$ ,  $V_{OUT} = 5\text{ V}$ ,  $T_A = 25^\circ\text{C}$ ; circuit and components according to Figure 1.

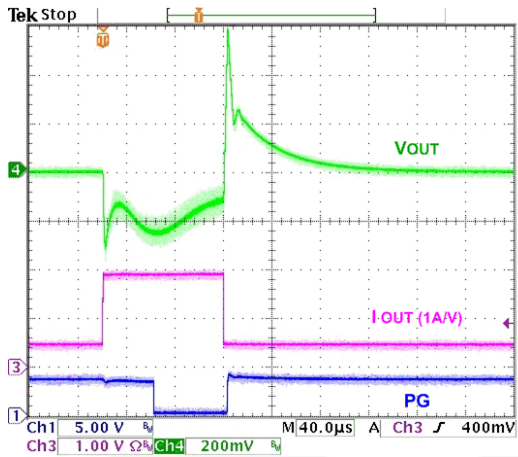

Figure 23. Transient Overload, 500-1950 mA, 100 ns Edge,  $V_{IN}=3\text{ V}$ ,  $V_{OUT}=3.5\text{ V}$

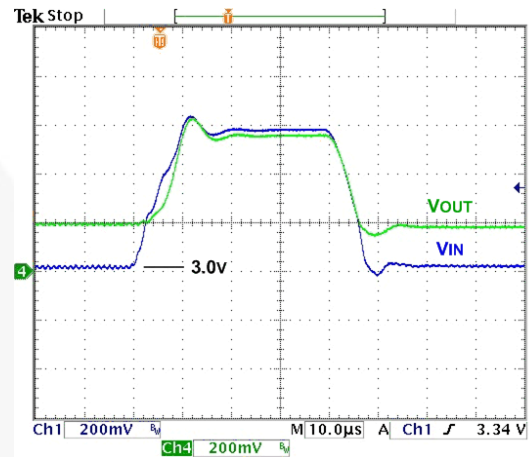

Figure 24. Line Transient, 3.0-3.6  $V_{IN}$ , 10  $\mu\text{s}$  Edge, 500 mA Load,  $V_{OUT}=3.15\text{ V}$

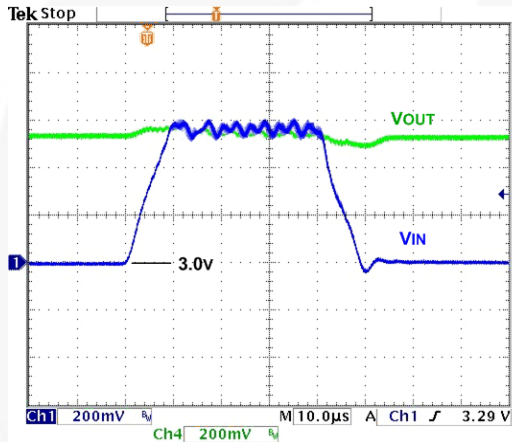

Figure 25. Line Transient, 3.0-3.6  $V_{IN}$ , 10  $\mu\text{s}$  Edge, 1,000 mA Load,  $V_{OUT}=3.5\text{ V}$

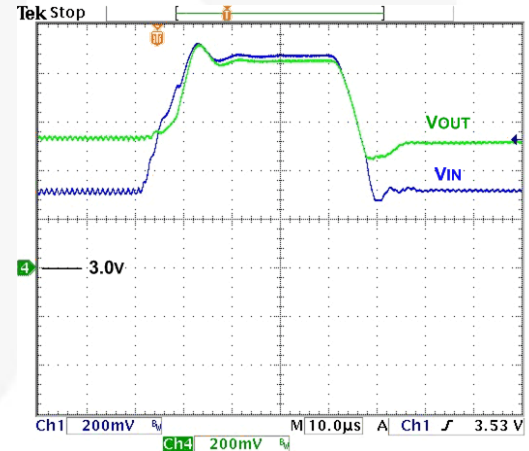

Figure 26. Line Transient, 3.3-3.9  $V_{IN}$ , 10  $\mu\text{s}$  Edge, 500 mA load,  $V_{OUT}=3.5\text{ V}$

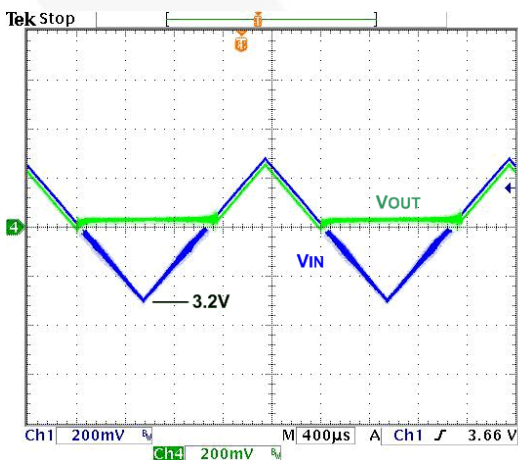

Figure 27. Bypass Entry / Exit, Slow  $V_{IN}$  Ramp 1 ms Edge, 500 mA Load,  $V_{OUT}=3.5\text{ V}$ , 3.2 - 3.8  $V_{IN}$

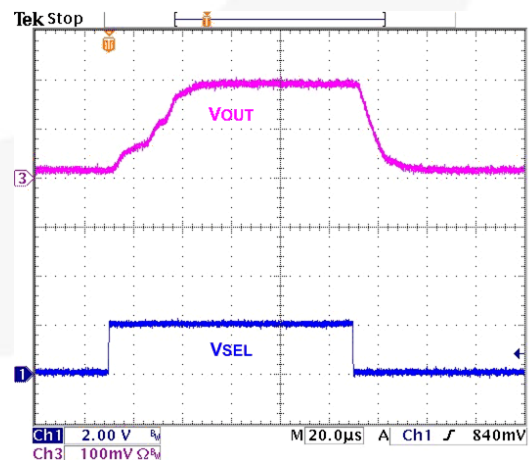

Figure 28.  $V_{SEL}$  Step,  $V_{IN}=3\text{ V}$ ,  $V_{OUT}=3.5\text{ V}$ , 500 mA Load

## Circuit Description

FAN48630 is a synchronous boost regulator, typically operating at 2.5 MHz in Continuous Conduction Mode (CCM), which occurs at moderate to heavy load current and low  $V_{IN}$  voltages. The regulator includes a Bypass Mode that activates when  $V_{IN}$  is above the boost regulator's setpoint.

In anticipation of a heavy load transition, the setpoint can be adjusted upward by fixed amounts with the VSEL pin to reduce the required system headroom during lighter-load operation to save power.

**Table 2. Operating States**

Mode	Description	Invoked When
LIN	Linear Startup	$V_{IN} > V_{OUT}$
SS	Boost Soft-Start	$V_{OUT} < V_{OUT\_TARGET}$
BST	Boost Operating Mode	$V_{OUT} = V_{OUT\_TARGET}$
BPS	Bypass Mode	$V_{IN} > V_{OUT\_TARGET}$

### Boost Mode

The FAN48630 uses a current-mode modulator to achieve excellent transient response and smooth transitions between CCM and Discontinuous Conduction Mode (DCM) operation. During CCM operation, the device maintains a switching frequency of about 2.5 MHz. In light-load operation (DCM), frequency is reduced to maintain high efficiency.

**Table 3. Boost Startup Sequence**

Start State	Entry	Exit	End State	Timeout ( $\mu$ s)
LIN1	$V_{IN} > UVLO$ , EN=1	$V_{OUT} > V_{IN} - 300$ mV	SS	
			LIN2	512
LIN2	LIN1 Exit	$V_{OUT} > V_{IN} - 300$ mV	SS	
		TIMEOUT	FAULT	1024
SS	LIN1 or LIN2 Exit	$V_{OUT} = V_{OUT\_TARGET}$	BST	
		OVERLOAD TIMEOUT	FAULT	64

### Shutdown and Startup

If EN is LOW, all bias circuits are off and the regulator is in Shutdown Mode. During shutdown, current flow is prevented from  $V_{IN}$  to  $V_{OUT}$ , as well as reverse flow from  $V_{OUT}$  to  $V_{IN}$ . During startup, it is recommended to keep DC current draw below 500 mA.

### LIN State

When EN is HIGH and  $V_{IN} > UVLO$ , the regulator attempts to bring  $V_{OUT}$  within 300 mV of  $V_{IN}$  using the internal fixed current source from  $V_{IN}$  (Q3). The current is limited to LIN1 set point.

If  $V_{OUT}$  reaches  $V_{IN} - 300$  mV during LIN1 Mode, the SS state is initiated. Otherwise, LIN1 times out after 512  $\mu$ s and LIN2 Mode is entered.

In LIN2 Mode, the current source is incremented to 2A. If  $V_{OUT}$  fails to reach  $V_{IN} - 300$  mV after 1024  $\mu$ s, a fault condition is declared.

### SS State

Upon the successful completion of the LIN state ( $V_{OUT} \geq V_{IN} - 300$  mV), the regulator begins switching with boost pulses current limited to 50% of nominal level.

During SS state,  $V_{OUT}$  is ramped up by stepping the internal reference. If  $V_{OUT}$  fails to reach regulation during the SS ramp sequence for more than 64  $\mu$ s, a fault condition is declared. If large  $C_{OUT}$  is used, the reference is automatically stepped slower to avoid excessive input current draw.

### BST State

This is a normal operating state of the regulator.

### BPS State

If  $V_{IN}$  is above  $V_{REG}$  when the SS Mode successfully completes, the device transitions directly to BPS Mode.

### FAST and SLOW Soft-Start Options

The fast startup versions feature EN to regulation time of 600  $\mu$ s. LIN1 and LIN2 phase currents are doubled compared to SLOW options, SS phase is also faster.

Slow startup achieves EN to regulation time of 1300  $\mu$ s to reduce inrush current.

**Table 4. EN and  $\overline{BYP}$  Logic Table**

EN	$\overline{BYP}$	Mode	$V_{OUT}$
0	0	Shutdown	0
	1	Shutdown	0
1	0	Forced Bypass	$V_{IN}$
	1	Auto Bypass	$V_{OUT\_TARGET}$ or $V_{IN}$ (if $V_{IN} > V_{OUT\_TARGET}$ )

### FAULT State

The regulator enters the FAULT state under any of the following conditions:

- $V_{OUT}$  fails to achieve the voltage required to advance from LIN state to SS state.
- $V_{OUT}$  fails to achieve the voltage required to advance from SS state to BST state.
- Boost current limit triggers for 2 ms during the BST state.
- $V_{DS}$  protection threshold is exceeded during BPS state.

Once a fault is triggered, the regulator stops switching and presents a high-impedance path between  $V_{IN}$  and  $V_{OUT}$ . After waiting 20 ms, a restart is attempted.

## Power Good

Power good is 0 FAULT, 1 POWER GOOD, open-drain output.

The Power good pin is provided for signaling the system when the regulator has successfully completed soft-start and no faults have occurred. Power good also functions as an early warning flag for high die temperature and overload conditions.

## Over-Temperature

The regulator shuts down when the die temperature exceeds 150°C. Restart occurs when the IC has cooled by approximately 20°C.

## Bypass Operation

In normal operation, the device automatically transitions from Boost Mode to Bypass Mode, if  $V_{IN}$  goes above target  $V_{OUT}$ . In Bypass Mode, the device fully enhances both Q1 and Q3 to provide a very low impedance path from  $V_{IN}$  to  $V_{OUT}$ . Entry to the Bypass Mode is triggered by condition where  $V_{IN} > V_{OUT}$  and no switching has occurred during past 5  $\mu$ s. To soften the entry to Bypass Mode, Q3 is driven as a linear current source for the first 5  $\mu$ s. Bypass Mode exit is triggered when  $V_{OUT}$  reaches the target  $V_{OUT}$  voltage. During Automatic Bypass Mode, the device is short-circuit protected by voltage comparator tracking the voltage drop from  $V_{IN}$  to  $V_{OUT}$ ; if the drop exceeds 200 mV, FAULT is declared.

With sufficient load to enforce CCM operation, the Bypass Mode to Boost Mode transition occurs at the target  $V_{OUT}$ . The corresponding input voltage at the transition point is:

$$V_{IN} \leq V_{OUT} + I_{LOAD} \cdot (DCR_L + R_{DS(ON)P}) \parallel R_{DS(ON)BYP} \quad \text{EQ. 1}$$

The Bypass Mode entry threshold has 25 mV hysteresis imposed at  $V_{OUT}$  to prevent cycling between modes. The transition from Boost Mode to Bypass Mode occurs at the target  $V_{OUT} + 25$  mV. The corresponding input voltage is:

$$V_{IN} \geq V_{OUT} + 25mV + I_{LOAD} \cdot (DCR_L + R_{DS(ON)P}) \quad \text{EQ. 2}$$

- PG is released HIGH when the soft-start sequence is successfully completed.
- PG is pulled LOW when PMOS current limit has triggered for 64  $\mu$ s OR the die the temperature exceeds 120°C. PG is re-asserted when the device cools below to 100°C.
- Any FAULT condition causes PG to be de-asserted.

## Forced Bypass

Entry to Forced Bypass Mode initiates with a current limit on Q3 and then proceeds to a true bypass state. To prevent reverse current to the battery, the device waits until output discharges below  $V_{IN}$  before entering Forced Bypass Mode.

For Low-IQ Forced Bypass versions, after the transition is complete, most of the internal circuitry is disabled to minimize quiescent current draw. Short-circuit, UVLO, output OVP and over-temperature protections are inactive in Forced Bypass Mode.

For OCP-On Forced Bypass versions, during Forced Bypass Mode, the device is short-circuit protected by a voltage comparator tracking the voltage drop from  $V_{IN}$  to  $V_{OUT}$ . If the drop exceeds 200 mV, a FAULT is declared. The over-temperature protection is also active.

## VSEL

$V_{SEL}$  can be asserted in anticipation of a positive load transient. Raising  $V_{SEL}$  increases  $V_{OUT\_TARGET}$  by a fixed amount and  $V_{OUT}$  is stepped to the corresponding target output voltage in 20  $\mu$ s. The functionality can also be utilized to mitigate undershoot during severe line transients, while minimizing  $V_{OUT}$  during more benign operating conditions to save power.

## EN

Setting the EN pin voltage below 0.4 V disables the part. Placing the voltage above 1.2 V enables the part. Do not connect the EN pin to  $V_{IN}$ . A logic voltage of 1.8 V should control the EN pin and enable / disable the device. The EN pin should be pulled HIGH after the  $V_{IN}$  voltage has reached a minimum voltage of 2.3 V.

## Application Information

### Output Capacitance (C<sub>OUT</sub>)

#### Stability

The effective capacitance (C<sub>EFF</sub>) of small, high-value, ceramic capacitors decreases as bias voltage increases.

FAN48630 is guaranteed for stable operation with the minimum value of C<sub>EFF</sub> (C<sub>EFF(MIN)</sub>) outlined in Table 5 below.

**Table 5. Minimum C<sub>EFF</sub> Required for Stability**

Operating Conditions		C <sub>EFF(MIN)</sub> (μF)
V <sub>OUT</sub> (V)	I <sub>LOAD</sub> (mA)	
3.15	0 to 1500	12
3.5	0 to 1500	9
4.5 and 5	0 to 1500	6

C<sub>EFF</sub> varies with manufacturer, material, and case size.

#### Inductor Selection

Recommended nominal inductance value is 0.47 μH.

FAN48630 employs valley-current limiting; peak inductor current can reach 3.8 A for a short duration during overload conditions. Saturation effects cause the inductor current ripple to become higher under high loading as only valley of the inductor current ripple is controlled.

For FAN48630UC315X and FAN48630UC33X, a 0.33 μH inductor can be used for improved transient performance.

#### Startup

Input current limiting is in effect during soft-start, which limits the current available to charge C<sub>OUT</sub> and any additional capacitance on the V<sub>OUT</sub> line. If the output fails to achieve regulation within the limits described in the Startup section, a FAULT occurs, causing the circuit to shut down then restart after a significant time period. If the total combined output capacitance is very high, the circuit may not start on the first attempt, but eventually achieves regulation if no load is present. If a high-current load and high capacitance are both present during soft-start, the circuit may fail to achieve regulation and continually attempts soft-start, only to have the output capacitance discharged by the load when in a FAULT state.

### Output Voltage Ripple

Output voltage ripple is inversely proportional to C<sub>OUT</sub>. During t<sub>ON</sub>, when the boost switch is on, all load current is supplied by C<sub>OUT</sub>. Output ripple is calculated as:

$$V_{RIPPLE(P-P)} = t_{ON} \cdot \frac{I_{LOAD}}{C_{OUT}} \quad \text{EQ. 3}$$

and

$$t_{ON} = t_{SW} \cdot D = t_{SW} \cdot \left(1 - \frac{V_{IN}}{V_{OUT}}\right) \quad \text{EQ. 4}$$

therefore:

$$V_{RIPPLE(P-P)} = t_{SW} \cdot \left(1 - \frac{V_{IN}}{V_{OUT}}\right) \cdot \frac{I_{LOAD}}{C_{OUT}} \quad \text{EQ. 5}$$

and

$$t_{SW} = \frac{1}{f_{SW}} \quad \text{EQ. 6}$$

As can be seen from EQ. 5, the maximum V<sub>RIPPLE</sub> OCCURS when V<sub>IN</sub> is at minimum and I<sub>LOAD</sub> is at maximum.

### Layout Recommendations

The layout recommendations below highlight various top-copper pours using different colors.

To minimize spikes at V<sub>OUT</sub>, C<sub>OUT</sub> must be placed as close as possible to PGND and V<sub>OUT</sub>, as shown in Figure 29.

For thermal reasons, it is suggested to maximize the pour area for all planes other than SW. Especially the ground pour should be set to fill all available PCB surface area and tied to internal layers with a cluster of thermal vias.

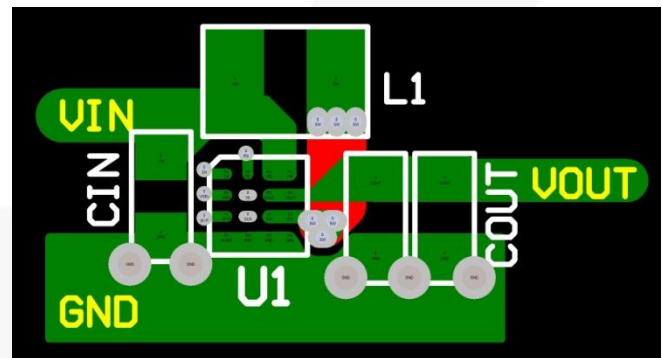

**Figure 29. Layout Recommendation**



## Product-Specific Dimensions

Product	D	E	X	Y
FAN48630UCxxxX	1.780 ±0.030	1.780 ±0.030	0.290	0.290
FAN48630BUCxxxX	1.780 ±0.030	1.780 ±0.030	0.290	0.290



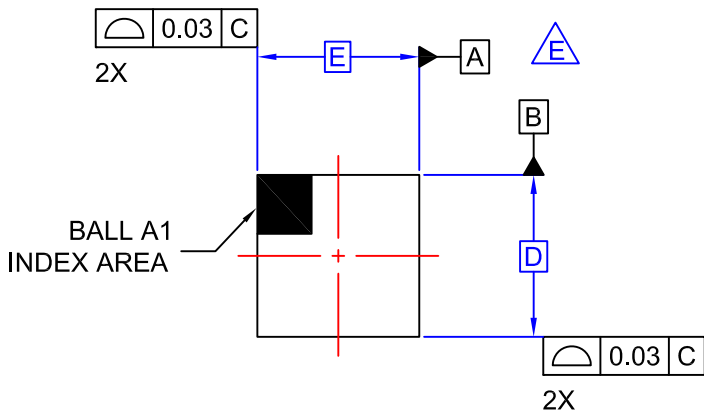

TOP VIEW

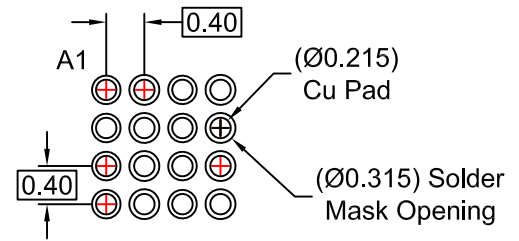

RECOMMENDED LAND PATTERN  
(NSMD PAD TYPE)

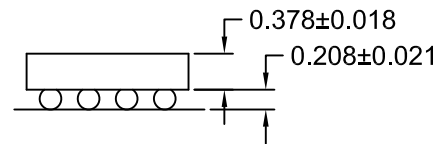
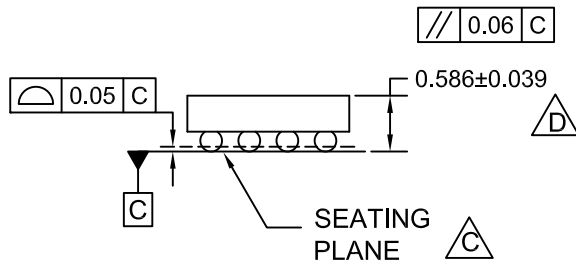

SIDE VIEWS

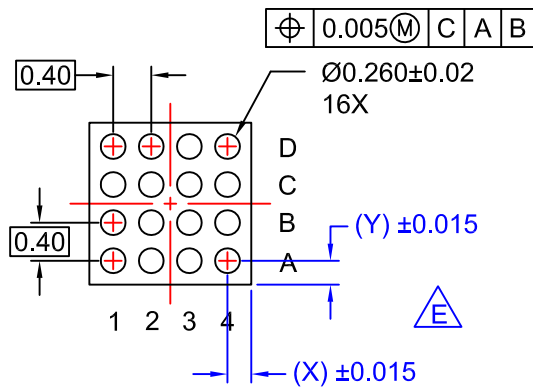

BOTTOM VIEW

NOTES

- A. NO JEDEC REGISTRATION APPLIES.
- B. DIMENSIONS ARE IN MILLIMETERS.
- C. DATUM C IS DEFINED BY THE SPHERICAL CROWNS OF THE BALLS.
- D. PACKAGE NOMINAL HEIGHT IS 586 ± 39 MICRONS (547-625 MICRONS).
- E. FOR DIMENSIONS D, E, X, AND Y SEE PRODUCT DATASHEET.
- F. DRAWING FILNAME: MKT-UC016AF revA

ON Semiconductor





ON Semiconductor and  are trademarks of Semiconductor Components Industries, LLC dba ON Semiconductor or its subsidiaries in the United States and/or other countries. ON Semiconductor owns the rights to a number of patents, trademarks, copyrights, trade secrets, and other intellectual property. A listing of ON Semiconductor's product/patent coverage may be accessed at [www.onsemi.com/site/pdf/Patent-Marking.pdf](http://www.onsemi.com/site/pdf/Patent-Marking.pdf). ON Semiconductor reserves the right to make changes without further notice to any products herein. ON Semiconductor makes no warranty, representation or guarantee regarding the suitability of its products for any particular purpose, nor does ON Semiconductor assume any liability arising out of the application or use of any product or circuit, and specifically disclaims any and all liability, including without limitation special, consequential or incidental damages. Buyer is responsible for its products and applications using ON Semiconductor products, including compliance with all laws, regulations and safety requirements or standards, regardless of any support or applications information provided by ON Semiconductor. "Typical" parameters which may be provided in ON Semiconductor data sheets and/or specifications can and do vary in different applications and actual performance may vary over time. All operating parameters, including "Typicals" must be validated for each customer application by customer's technical experts. ON Semiconductor does not convey any license under its patent rights nor the rights of others. ON Semiconductor products are not designed, intended, or authorized for use as a critical component in life support systems or any FDA Class 3 medical devices or medical devices with a same or similar classification in a foreign jurisdiction or any devices intended for implantation in the human body. Should Buyer purchase or use ON Semiconductor products for any such unintended or unauthorized application, Buyer shall indemnify and hold ON Semiconductor and its officers, employees, subsidiaries, affiliates, and distributors harmless against all claims, costs, damages, and expenses, and reasonable attorney fees arising out of, directly or indirectly, any claim of personal injury or death associated with such unintended or unauthorized use, even if such claim alleges that ON Semiconductor was negligent regarding the design or manufacture of the part. ON Semiconductor is an Equal Opportunity/Affirmative Action Employer. This literature is subject to all applicable copyright laws and is not for resale in any manner.

## PUBLICATION ORDERING INFORMATION

### LITERATURE FULFILLMENT:

Literature Distribution Center for ON Semiconductor  
19521 E. 32nd Pkwy, Aurora, Colorado 80011 USA  
**Phone:** 303-675-2175 or 800-344-3860 Toll Free USA/Canada  
**Fax:** 303-675-2176 or 800-344-3867 Toll Free USA/Canada  
**Email:** [orderlit@onsemi.com](mailto:orderlit@onsemi.com)

**N. American Technical Support:** 800-282-9855 Toll Free  
USA/Canada  
**Europe, Middle East and Africa Technical Support:**  
Phone: 421 33 790 2910  
**Japan Customer Focus Center**  
Phone: 81-3-5817-1050

**ON Semiconductor Website:** [www.onsemi.com](http://www.onsemi.com)  
**Order Literature:** <http://www.onsemi.com/orderlit>  
For additional information, please contact your local  
Sales Representative

# Mouser Electronics

Authorized Distributor

Click to View Pricing, Inventory, Delivery & Lifecycle Information:

## ON Semiconductor:

[FAN48630UC315X](#) [FAN48630UC33X](#) [FAN48630UC35X](#) [FAN48630UC37AX](#) [FAN48630UC50X](#) [FAN48630UC45X](#)  
[FAN48630BUC33X](#) [FAN48630BUC315X](#) [FAN48630BUC34X](#) [FAN48630BUC31JX](#)

Компания «Океан Электроники» предлагает заключение долгосрочных отношений при поставках импортных электронных компонентов на взаимовыгодных условиях!

Наши преимущества:

- Поставка оригинальных импортных электронных компонентов напрямую с производств Америки, Европы и Азии, а так же с крупнейших складов мира;
- Широкая линейка поставок активных и пассивных импортных электронных компонентов (более 30 млн. наименований);
- Поставка сложных, дефицитных, либо снятых с производства позиций;
- Оперативные сроки поставки под заказ (от 5 рабочих дней);
- Экспресс доставка в любую точку России;
- Помощь Конструкторского Отдела и консультации квалифицированных инженеров;
- Техническая поддержка проекта, помощь в подборе аналогов, поставка прототипов;
- Поставка электронных компонентов под контролем ВП;
- Система менеджмента качества сертифицирована по Международному стандарту ISO 9001;
- При необходимости вся продукция военного и аэрокосмического назначения проходит испытания и сертификацию в лаборатории (по согласованию с заказчиком);
- Поставка специализированных компонентов военного и аэрокосмического уровня качества (Xilinx, Altera, Analog Devices, Intersil, Interpoint, Microsemi, Actel, Aeroflex, Peregrine, VPT, Syfer, Eurofarad, Texas Instruments, MS Kennedy, Miteq, Cobham, E2V, MA-COM, Hittite, Mini-Circuits, General Dynamics и др.);

Компания «Океан Электроники» является официальным дистрибьютором и эксклюзивным представителем в России одного из крупнейших производителей разъемов военного и аэрокосмического назначения «JONHON», а так же официальным дистрибьютором и эксклюзивным представителем в России производителя высокотехнологичных и надежных решений для передачи СВЧ сигналов «FORSTAR».



## JONHON

«JONHON» (основан в 1970 г.)

Разъемы специального, военного и аэрокосмического назначения:

(Применяются в военной, авиационной, аэрокосмической, морской, железнодорожной, горно- и нефтедобывающей отраслях промышленности)

«FORSTAR» (основан в 1998 г.)

ВЧ соединители, коаксиальные кабели,  
кабельные сборки и микроволновые компоненты:

(Применяются в телекоммуникациях гражданского и специального назначения, в средствах связи, РЛС, а так же военной, авиационной и аэрокосмической отраслях промышленности).



Телефон: 8 (812) 309-75-97 (многоканальный)

Факс: 8 (812) 320-03-32

Электронная почта: [ocean@oceanchips.ru](mailto:ocean@oceanchips.ru)

Web: <http://oceanchips.ru/>

Адрес: 198099, г. Санкт-Петербург, ул. Калинина, д. 2, корп. 4, лит. А