

## ADC161S626 16-Bit, 50 to 250 kSPS, Differential Input, MicroPower ADC

### 1 Features

- 16-bit Resolution With No Missing Codes
- Ensured Performance from 50 to 250 kSPS
- $\pm 0.003\%$  Signal Span Accuracy
- Separate Digital Input/Output Supply
- True Differential Input
- External Voltage Reference Range of 0.5 V to  $V_A$
- Zero-Power Track Mode with 0- $\mu$ sec Wake-up Delay
- Wide Input Common-mode Voltage Range of 0 V to  $V_A$
- SPI/QSPI™/MICROWIRE™ Compatible Serial Interface
- Operating Temperature Range of  $-40^\circ\text{C}$  to  $+85^\circ\text{C}$
- Small VSSOP-10 Package
- Key Specifications
  - Conversion Rate 50 to 250 kSPS
  - DNL  $+0.8 / -0.5$  LSB
  - INL  $\pm 0.8$  LSB
  - Offset Error Temp Drift  $2.5 \mu\text{V}/^\circ\text{C}$
  - Gain Error Temp Drift  $0.3 \text{ ppm}/^\circ\text{C}$
  - SNR 93.2 dBc
  - THD – 104 dBc
  - Power Consumption
    - 10 kSPS, 5 V 0.24 mW
    - 200 kSPS, 5 V 5.3 mW
    - 250 kSPS, 5 V 5.8 mW
    - Power-Down, 5 V 10  $\mu\text{W}$

### 2 Applications

- Direct Sensor Interface
- I/O Modules
- Data Acquisition
- Portable Systems
- Motor Control
- Medical Instruments
- Instrumentation and Control Systems

### 3 Description

The ADC161S626 is a 16-bit successive-approximation register (SAR) Analog-to-Digital converter (ADC) with a maximum sampling rate of 250 kSPS. The ADC161S626 has a minimum signal span accuracy of  $\pm 0.003\%$  over the temperature range of  $-40^\circ\text{C}$  to  $+85^\circ\text{C}$ . The converter features a differential analog input with an excellent common-mode signal rejection ratio of 85 dB, making the ADC161S626 suitable for noisy environments.

The ADC161S626 operates with a single analog supply ( $V_A$ ) and a separate digital input/output ( $V_{IO}$ ) supply.  $V_A$  can range from 4.5 V to 5.5 V and  $V_{IO}$  can range from 2.7 V to 5.5 V. This allows a system designer to maximize performance and minimize power consumption by operating the analog portion of the ADC at a  $V_A$  of 5 V while interfacing with a 3.3-V controller. The serial data output is binary 2's complement and is SPI compatible.

The performance of the ADC161S626 is ensured over temperature at clock rates of 1 MHz to 5 MHz and reference voltages of 2.5 V to 5.5 V. The ADC161S626 is available in a small 10-lead VSSOP package. The high accuracy, differential input, low power consumption, and small size make the ADC161S626 ideal for direct connection to bridge sensors and transducers in battery operated systems or remote data acquisition applications.

#### Device Information<sup>(1)</sup>

PART NUMBER	PACKAGE	BODY SIZE (NOM)
ADC161S626	VSSOP (10)	3.00 mm x 3.00 mm

(1) For all available packages, see the orderable addendum at the end of the datasheet.

#### Typical Application Schematic

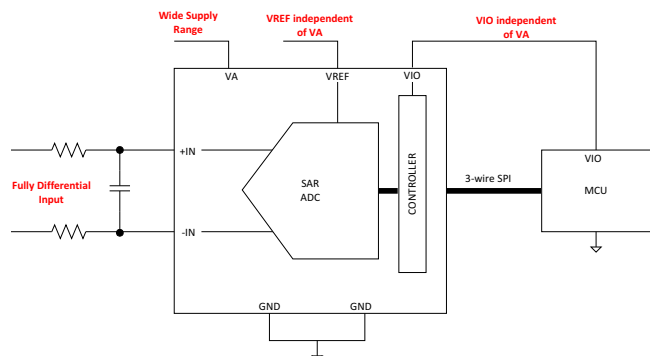

## Table of Contents

<b>1 Features</b> .....	<b>1</b>	7.4 Device Functional Modes.....	<b>18</b>
<b>2 Applications</b> .....	<b>1</b>	<b>8 Application and Implementation</b> .....	<b>22</b>
<b>3 Description</b> .....	<b>1</b>	8.1 Application Information.....	<b>22</b>
<b>4 Revision History</b> .....	<b>2</b>	8.2 Typical Application .....	<b>22</b>
<b>5 Pin Configuration and Functions</b> .....	<b>3</b>	<b>9 Power Supply Recommendations</b> .....	<b>24</b>
<b>6 Specifications</b> .....	<b>3</b>	9.1 Analog and Digital Power Supplies.....	<b>24</b>
6.1 Absolute Maximum Ratings .....	<b>3</b>	9.2 Voltage Reference .....	<b>24</b>
6.2 ESD Ratings.....	<b>4</b>	<b>10 Layout</b> .....	<b>24</b>
6.3 Recommended Operating Conditions.....	<b>4</b>	10.1 Layout Guidelines .....	<b>24</b>
6.4 Thermal Information .....	<b>4</b>	10.2 Layout Example .....	<b>25</b>
6.5 Converter Electrical Characteristics.....	<b>5</b>	<b>11 Device and Documentation Support</b> .....	<b>26</b>
6.6 Timing Requirements.....	<b>7</b>	11.1 Device Support.....	<b>26</b>
6.7 Typical Characteristics.....	<b>9</b>	11.2 Trademarks .....	<b>27</b>
<b>7 Detailed Description</b> .....	<b>15</b>	11.3 Electrostatic Discharge Caution.....	<b>27</b>
7.1 Overview .....	<b>15</b>	11.4 Glossary .....	<b>27</b>
7.2 Functional Block Diagram .....	<b>15</b>	<b>12 Mechanical, Packaging, and Orderable Information</b> .....	<b>27</b>
7.3 Feature Description.....	<b>15</b>		

## 4 Revision History

### Changes from Revision C (March 2013) to Revision D

**Page**

- Added *Pin Configuration and Functions* section, *ESD Ratings* table, *Feature Description* section, *Device Functional Modes*, *Application and Implementation* section, *Power Supply Recommendations* section, *Layout* section, *Device and Documentation Support* section, and *Mechanical, Packaging, and Orderable Information* section ..... **1**

## 5 Pin Configuration and Functions

10 Pins  
VSSOP Package  
Top View

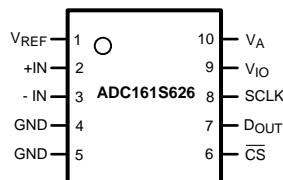

Pin Functions

PIN		I/O	DESCRIPTION
NO.	NAME		
1	$V_{REF}$	I	Voltage Reference $0.5\text{ V} < V_{REF} < V_A$
2	+IN	I	Non-Inverting Input
3	-IN	I	Inverting Input
4	GND	Power	Ground
5	GND	Power	Ground
6	$\overline{CS}$	I	Chip Select Bar
7	$D_{OUT}$	O	Serial Data Output
8	SCLK	I	Serial Clock
9	$V_{IO}$	Power	Digital Input/Output Power $2.7\text{ V} < V_{REF} < 5.5\text{ V}$
10	$V_A$	Power	Analog Power $4.5\text{ V} < V_{REF} < 5.5\text{ V}$

## 6 Specifications

### 6.1 Absolute Maximum Ratings<sup>(1)(2)(3)</sup>

	MIN	MAX	UNIT
Analog Supply Voltage $V_A$	-0.3	6.5	V
Digital I/O Supply Voltage $V_{IO}$	-0.3	6.5	V
Voltage on Any Analog Input Pin to GND	-0.3	$(V_A + 0.3)$	V
Voltage on Any Digital Input Pin to GND	-0.3	$(V_{IO} + 0.3)$	V
Input Current at Any Pin <sup>(4)</sup>	-10	10	mA
Package Input Current <sup>(4)</sup>	-50	50	mA
Power Consumption at $T_A = 25^\circ\text{C}$		See <sup>(5)</sup>	
Junction Temperature		150	$^\circ\text{C}$
Storage temperature, $T_{stg}$	-65	150	$^\circ\text{C}$

- (1) Stresses beyond those listed under *Absolute Maximum Ratings* may cause permanent damage to the device. These are stress ratings only, which do not imply functional operation of the device at these or any other conditions beyond those indicated under *Recommended Operating Conditions*. Exposure to absolute-maximum-rated conditions for extended periods may affect device reliability.
- (2) All voltages are measured with respect to GND = 0 V, unless otherwise specified.
- (3) If Military/Aerospace specified devices are required, please contact the TI Sales Office/ Distributors for availability and specifications.
- (4) When the input voltage at any pin exceeds the power supplies (that is,  $V_{IN} < \text{GND}$  or  $V_{IN} > V_A$ ), the current at that pin should be limited to 10 mA. The 50 mA maximum package input current rating limits the number of pins that can safely exceed the power supplies with an input current of 10 mA to five.
- (5) The absolute maximum junction temperature ( $T_{Jmax}$ ) for this device is  $150^\circ\text{C}$ . The maximum allowable power dissipation is dictated by  $T_{Jmax}$ , the junction-to-ambient thermal resistance ( $\theta_{JA}$ ), and the ambient temperature ( $T_A$ ), and can be calculated using the formula  $P_{DMAX} = (T_{Jmax} - T_A)/\theta_{JA}$ . The values for maximum power dissipation listed above will be reached only when the ADC161S626 is operated in a severe fault condition (e.g. when input or output pins are driven beyond the power supply voltages, or the power supply polarity is reversed). Such conditions should always be avoided.

## 6.2 ESD Ratings

		VALUE	UNIT
$V_{(ESD)}$ Electrostatic discharge	Human body model (HBM), per ANSI/ESDA/JEDEC JS-001 <sup>(1)</sup>	±2500	V
	Charged-device model (CDM), per JEDEC specification JESD22-C101 <sup>(2)</sup>	±1250	
	Machine model (MM)	250	

(1) JEDEC document JEP155 states that 500-V HBM allows safe manufacturing with a standard ESD control process.

(2) JEDEC document JEP157 states that 250-V CDM allows safe manufacturing with a standard ESD control process.

## 6.3 Recommended Operating Conditions

over operating free-air temperature range (unless otherwise noted)<sup>(1)</sup>

	MIN	MAX	UNIT
Operating Temperature Range	-40	85	°C
Supply Voltage, $V_A$	4.5	5.5	V
Supply Voltage, $V_{IO}$	2.7	5.5	V
Reference Voltage, $V_{REF}$	0.5	$V_A$	V
Analog Input Pins Voltage Range	0	$V_A$	V
Differential Analog Input Voltage	$-V_{REF}$	$+V_{REF}$	V
Input Common-Mode Voltage, $V_{CM}$	See <a href="#">Figure 44</a>		
Digital Input Pins Voltage Range	0	$V_{IO}$	V
Clock Frequency	1	5	MHz

(1) All voltages are measured with respect to GND = 0V, unless otherwise specified.

## 6.4 Thermal Information

THERMAL METRIC <sup>(1)</sup>		ADC161S626	UNIT
		DGS	
		10 PINS	
$R_{\theta JA}$	Junction-to-ambient thermal resistance	163	°C/W
$R_{\theta JC(top)}$	Junction-to-case (top) thermal resistance	57	
$R_{\theta JB}$	Junction-to-board thermal resistance	82	
$\Psi_{JT}$	Junction-to-top characterization parameter	6	
$\Psi_{JB}$	Junction-to-board characterization parameter	81	

(1) For more information about traditional and new thermal metrics, see the *IC Package Thermal Metrics* application report, [SPRA953](#).

## 6.5 Converter Electrical Characteristics

The following specifications apply for  $V_A = 4.5\text{ V}$  to  $5.5\text{ V}$ ,  $V_{IO} = 2.7\text{ V}$  to  $5.5\text{ V}$ , and  $V_{REF} = 2.5\text{ V}$  to  $5.5\text{ V}$  for  $f_{SCLK} = 1\text{ MHz}$  to  $4\text{ MHz}$  or  $V_{REF} = 4.5\text{ V}$  to  $5.5\text{ V}$  for  $f_{SCLK} = 1\text{ MHz}$  to  $5\text{ MHz}$ ;  $f_{IN} = 20\text{ kHz}$ , and  $C_L = 25\text{ pF}$ , unless otherwise noted. Maximum and minimum values apply for  $T_A = T_{MIN}$  to  $T_{MAX}$ ; the typical values are tested at  $T_A = 25^\circ\text{C}$ .<sup>(1)</sup>

PARAMETER		TEST CONDITIONS	MIN	TYP	MAX	UNIT
<b>STATIC CONVERTER CHARACTERISTICS</b>						
	Resolution with No Missing Codes				16	Bits
DNL	Differential Non-Linearity		-1	-0.5/+0.8	+2	LSB
INL	Integral Non-Linearity		-2	±0.8	+2	LSB
OE	Offset Error	$V_{REF} = 2.5\text{ V}$	-1	-0.1	+1	mV
		$V_{REF} = 5\text{ V}$		-0.4		mV
OE <sub>DRIFT</sub>	Offset Error Temperature Drift	$V_{REF} = 2.5\text{ V}$		3.7		µV/°C
		$V_{REF} = 5\text{ V}$		2.5		µV/°C
FSE	Positive Full-Scale Error		-0.03	-0.003	0.03	%FS
	Negative Full-Scale Error		-0.03	-0.002	0.03	%FS
GE	Positive Gain Error		-0.02	-0.002	0.02	%FS
	Negative Gain Error		-0.02	-0.0001	0.02	%FS
GE <sub>DRIFT</sub>	Gain Error Temperature Drift			0.3		ppm/°C
<b>DYNAMIC CONVERTER CHARACTERISTICS</b>						
SINAD	Signal-to-Noise Plus Distortion Ratio	$V_{REF} = 2.5\text{ V}$	85	88		dBc
		$V_{REF} = 4.5\text{ V}$ to $5.5\text{ V}$	89	93.0		dBc
SNR	Signal-to-Noise Ratio	$V_{REF} = 2.5\text{ V}$	85	88		dBc
		$V_{REF} = 4.5\text{ V}$ to $5.5\text{ V}$	89	93.2		dBc
THD	Total Harmonic Distortion	$V_{REF} = 2.5\text{ V}$		-104		dBc
		$V_{REF} = 4.5\text{ V}$ to $5.5\text{ V}$		-106		dBc
SFDR	Spurious-Free Dynamic Range	$V_{REF} = 2.5\text{ V}$		108		dBc
		$V_{REF} = 4.5\text{ V}$ to $5.5\text{ V}$		111		dBc
ENOB	Effective Number of Bits	$V_{REF} = 2.5\text{ V}$	13.8	14.3		bits
		$V_{REF} = 4.5\text{ V}$ to $5.5\text{ V}$	14.5	15.2		bits
FPBW	-3 dB Full Power Bandwidth	Output at 70.7%FS with FS Differential Input		26		MHz
<b>ANALOG INPUT CHARACTERISTICS</b>						
V <sub>IN</sub>	Differential Input Range		-V <sub>REF</sub>		+V <sub>REF</sub>	V
I <sub>INA</sub>	Analog Input Current	$\overline{CS}$ high	-1		1	µA
		$V_{REF} = 5\text{ V}$ , $V_{IN} = 0\text{ V}$ , $f_S = 50\text{ kSPS}$		3.2		nA
		$V_{REF} = 5\text{ V}$ , $V_{IN} = 0\text{ V}$ , $f_S = 200\text{ kSPS}$		10.3		nA
C <sub>INA</sub>	Input Capacitance (+IN or -IN)	In Acquisition Mode		20		pF
		In Conversion Mode		4		pF
CMRR	Common Mode Rejection Ratio	See the <a href="#">Specification Definitions</a> for the test condition		85		dB
<b>DIGITAL INPUT CHARACTERISTICS</b>						
V <sub>IH</sub>	Input High Voltage	$f_{IN} = 0\text{ Hz}$	$0.7 \times V_{IO}$	1.9		V
V <sub>IL</sub>	Input Low Voltage	$f_{IN} = 0\text{ Hz}$		1.7	$0.3 \times V_{IO}$	V
I <sub>IND</sub>	Digital Input Current		-1		1	µA
C <sub>IND</sub>	Input Capacitance				4	pF

(1) Typical values are at  $T_J = 25^\circ\text{C}$  and represent most likely parametric norms. Test limits are specified to AOQL (Average Outgoing Quality Level).

## Converter Electrical Characteristics (continued)

The following specifications apply for  $V_A = 4.5\text{ V to }5.5\text{ V}$ ,  $V_{IO} = 2.7\text{ V to }5.5\text{ V}$ , and  $V_{REF} = 2.5\text{ V to }5.5\text{ V}$  for  $f_{SCLK} = 1\text{ MHz to }4\text{ MHz}$  or  $V_{REF} = 4.5\text{ V to }5.5\text{ V}$  for  $f_{SCLK} = 1\text{ MHz to }5\text{ MHz}$ ;  $f_{IN} = 20\text{ kHz}$ , and  $C_L = 25\text{ pF}$ , unless otherwise noted. Maximum and minimum values apply for  $T_A = T_{MIN}$  to  $T_{MAX}$ ; the typical values are tested at  $T_A = 25^\circ\text{C}$ .<sup>(1)</sup>

PARAMETER		TEST CONDITIONS	MIN	TYP	MAX	UNIT
<b>DIGITAL OUTPUT CHARACTERISTICS</b>						
$V_{OH}$	Output High Voltage	$I_{SOURCE} = 200\ \mu\text{A}$	$V_{IO} - 0.2$	$V_{IO} - 0.03$		V
		$I_{SOURCE} = 1\text{ mA}$		$V_{IO} - 0.09$		V
$V_{OL}$	Output Low Voltage	$I_{SOURCE} = 200\ \mu\text{A}$		0.01	0.4	V
		$I_{SOURCE} = 1\text{ mA}$		0.07		V
$I_{OZH}, I_{OZL}$	TRI-STATE Leakage Current	Force 0V or $V_A$	-1		1	$\mu\text{A}$
$C_{OUT}$	TRI-STATE Output Capacitance	Force 0V or $V_A$		4		pF
	Output Coding			Binary 2's Complement		
<b>POWER SUPPLY CHARACTERISTICS</b>						
$V_A$	Analog Supply Voltage Range		4.5	5	5.5	V
$V_{IO}$	Digital Input/Output Supply Voltage Range	(2)	2.7	3	5.5	V
$V_{REF}$	Reference Voltage Range		0.5	5	$V_A$	V
$I_{VA}$ (Conv)	Analog Supply Current, Conversion Mode	$V_A = 5\text{ V}, f_{SCLK} = 4\text{ MHz}, f_S = 200\text{ kSPS}$		1060		$\mu\text{A}$
		$V_A = 5\text{ V}, f_{SCLK} = 5\text{ MHz}, f_S = 250\text{ kSPS}$		1160	1340	$\mu\text{A}$
$I_{VIO}$ (Conv)	Digital I/O Supply Current, Conversion Mode	$V_{IO} = 3\text{ V}, f_{SCLK} = 4\text{ MHz}, f_S = 200\text{ kSPS}$		80		$\mu\text{A}$
		$V_{IO} = 3\text{ V}, f_{SCLK} = 5\text{ MHz}, f_S = 250\text{ kSPS}$		100		$\mu\text{A}$
$I_{VREF}$ (Conv)	Reference Current, Conversion Mode	$V_A = 5\text{ V}, f_{SCLK} = 4\text{ MHz}, f_S = 200\text{ kSPS}$		80		$\mu\text{A}$
		$V_A = 5\text{ V}, f_{SCLK} = 5\text{ MHz}, f_S = 250\text{ kSPS}$		100	170	$\mu\text{A}$
$I_{VA}$ (PD)	Analog Supply Current, Power Down Mode ( $\overline{CS}$ high)	$f_{SCLK} = 5\text{ MHz}, V_A = 5\text{ V}$		7		$\mu\text{A}$
		$f_{SCLK} = 0\text{ Hz}, V_A = 5\text{ V}^{(3)}$		2	3	$\mu\text{A}$
$I_{VIO}$ (PD)	Digital I/O Supply Current, Power Down Mode ( $\overline{CS}$ high)	$f_{SCLK} = 5\text{ MHz}, V_{IO} = 3\text{ V}$		1		$\mu\text{A}$
		$f_{SCLK} = 0\text{ Hz}, V_{IO} = 3\text{ V}^{(3)}$		0.3	0.5	$\mu\text{A}$
$I_{VREF}$ (PD)	Reference Current, Power Down Mode ( $\overline{CS}$ high)	$f_{SCLK} = 5\text{ MHz}, V_{REF} = 5\text{ V}$		0.5		$\mu\text{A}$
		$f_{SCLK} = 0\text{ Hz}, V_{REF} = 5\text{ V}^{(3)}$		0.5	0.7	$\mu\text{A}$
PWR (Conv)	Power Consumption, Conversion Mode	$V_A = 5\text{ V}, f_{SCLK} = 4\text{ MHz}, f_S = 200\text{ kSPS}$ , and $f_{IN} = 20\text{ kHz}$ ,		5.3		mW
		$V_A = 5\text{ V}, f_{SCLK} = 5\text{ MHz}, f_S = 250\text{ kSPS}$ , and $f_{IN} = 20$		5.8	6.7	mW
PWR (PD)	Power Consumption, Power Down Mode ( $\overline{CS}$ high)	$f_{SCLK} = 5\text{ MHz}, V_A = 5.0\text{ V}^{(3)}$		35		$\mu\text{W}$
		$f_{SCLK} = 0\text{ Hz}, V_A = 5.0\text{ V}^{(3)}$		10	15	$\mu\text{W}$
PSRR	Power Supply Rejection Ratio	See the <a href="#">Specification Definitions</a> for the test condition		-78		dB
<b>AC ELECTRICAL CHARACTERISTICS</b>						
$f_{SCLK}$	Maximum Clock Frequency		1		5	MHz
$f_S$	Maximum Sample Rate		(4)50		250	kSPS
$t_{ACQ}$	Acquisition/Track Time		600			ns
$t_{CONV}$	Conversion/Hold Time				17	SCLK cycles
$t_{AD}$	Aperture Delay	See the <a href="#">Specification Definitions</a>		6		ns

(2) The value of  $V_{IO}$  is independent of the value of  $V_A$ . For example,  $V_{IO}$  could be operating at 5.5 V while  $V_A$  is operating at 4.5V or  $V_{IO}$  could be operating at 2.7 V while  $V_A$  is operating at 5.5 V.

(3) This parameter is ensured by design and/or characterization and is not tested in production.

(4) While the maximum sample rate is  $f_{SCLK} / 20$ , the actual sample rate may be lower than this by having the  $\overline{CS}$  rate slower than  $f_{SCLK} / 20$ .

### 6.6 Timing Requirements

The following specifications apply for  $V_A = 4.5\text{ V to }5.5\text{ V}$ ,  $V_{IO} = 2.7\text{ V to }5.5\text{ V}$ ,  $V_{REF} = 2.5\text{ V to }5.5\text{ V}$ ,  $f_{SCLK} = 1\text{ Mz to }5\text{ MHz}$ , and  $C_L = 25\text{ pF}$ , unless otherwise noted. Maximum and minimum values apply for  $T_A = T_{MIN}$  to  $T_{MAX}$ ; the typical values are tested at  $T_A = 25^\circ\text{C}$ .<sup>(1)</sup>

		MIN	NOM	MAX	UNIT
$t_{CSS}$	$\overline{CS}$ Setup Time prior to an SCLK rising edge	8	3		ns
$t_{CSH}$	$\overline{CS}$ Hold Time after an SCLK rising edge	8	3		
$t_{DH}$	$D_{OUT}$ Hold Time after an SCLK falling edge	6	11		ns
$t_{DA}$	$D_{OUT}$ Access Time after an SCLK falling edge		18	41	ns
$t_{DIS}$	$D_{OUT}$ Disable Time after the rising edge of $\overline{CS}$ <sup>(2)</sup>		20	30	ns
$t_{CS}$	Minimum $\overline{CS}$ Pulse Width	20			ns
$t_{EN}$	$D_{OUT}$ Enable Time after the 2nd falling edge of SCLK		20	70	ns
$t_{CH}$	SCLK High Time	20			ns
$t_{CL}$	SCLK Low Time	20			ns
$t_r$	$D_{OUT}$ Rise Time		7		ns
$t_f$	$D_{OUT}$ Fall Time		7		ns

- (1) Typical values are at  $T_J = 25^\circ\text{C}$  and represent most likely parametric norms. Test limits are specified to AOQL (Average Outgoing Quality Level).
- (2)  $t_{DIS}$  is the time for  $D_{OUT}$  to change 10% while being loaded by the Timing Test Circuit.

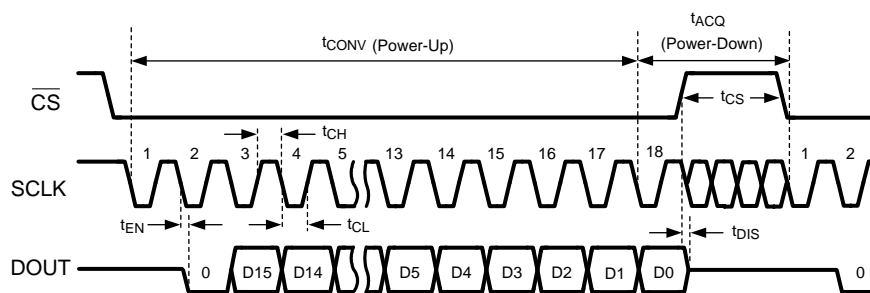

Figure 1. ADC161S626 Single Conversion Timing Diagram

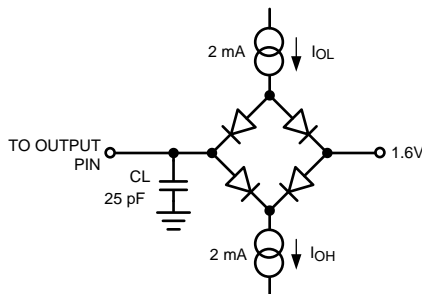

Figure 2. Timing Test Circuit

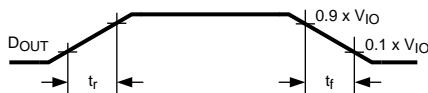
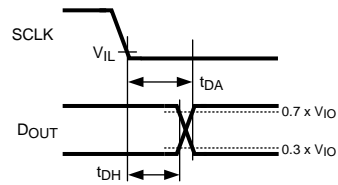
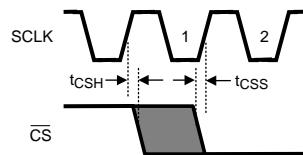
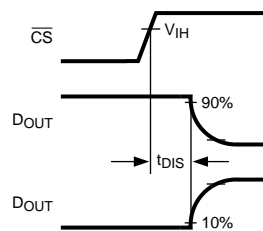

Figure 3.  $D_{OUT}$  Rise and Fall Times

**Figure 4. D<sub>OUT</sub> Hold and Access Times**

**Figure 5. Valid  $\overline{CS}$  Assertion Times**

**Figure 6. Voltage Waveform for t<sub>DIS</sub>**



## 6.7 Typical Characteristics

$V_A = V_{IO} = V_{REF} = 5\text{ V}$ ,  $f_{SCLK} = 5\text{ MHz}$ ,  $f_{SAMPLE} = 250\text{ kSPS}$ ,  $T_A = +25^\circ\text{C}$ , and  $f_{IN} = 20\text{ kHz}$  unless otherwise stated.

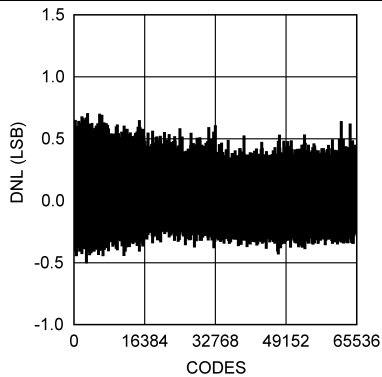

Figure 7. DNL - 250 kSPS

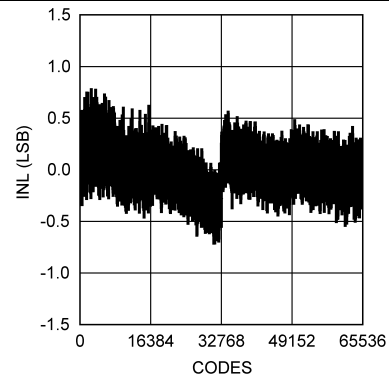

Figure 8. INL - 250 kSPS

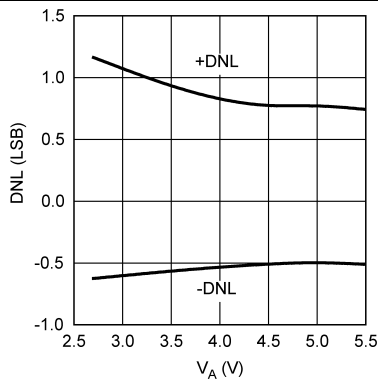

Figure 9. DNL vs.  $V_A$

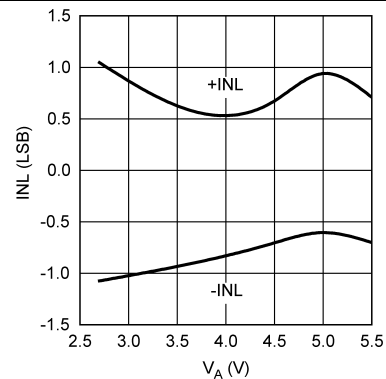

Figure 10. INL vs.  $V_A$

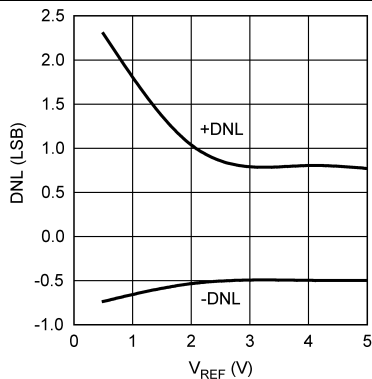

Figure 11. DNL vs.  $V_{REF}$

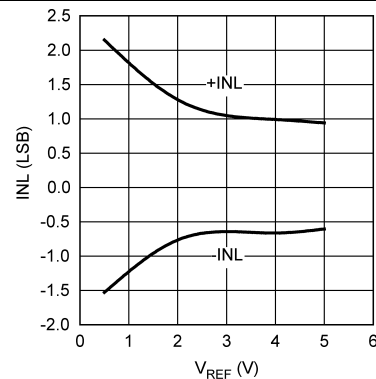

Figure 12. INL vs.  $V_{REF}$

Typical Characteristics (continued)

$V_A = V_{IO} = V_{REF} = 5\text{ V}$ ,  $f_{SCLK} = 5\text{ MHz}$ ,  $f_{SAMPLE} = 250\text{ kSPS}$ ,  $T_A = +25^\circ\text{C}$ , and  $f_{IN} = 20\text{ kHz}$  unless otherwise stated.

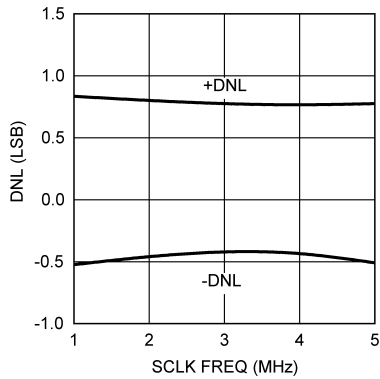

Figure 13. DNL vs. SCLK Frequency

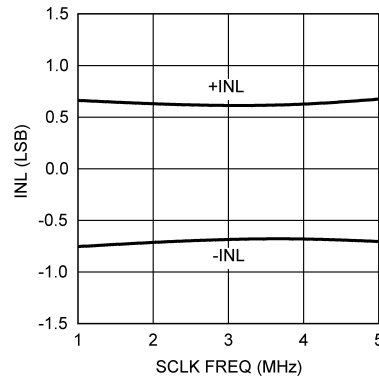

Figure 14. INL vs. SCLK Frequency

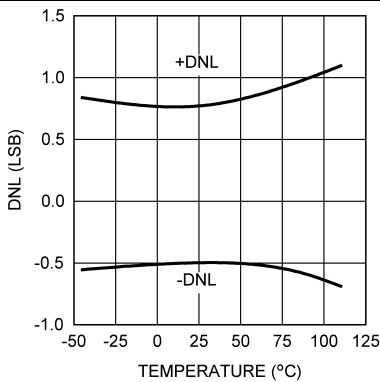

Figure 15. DNL vs. Temperature

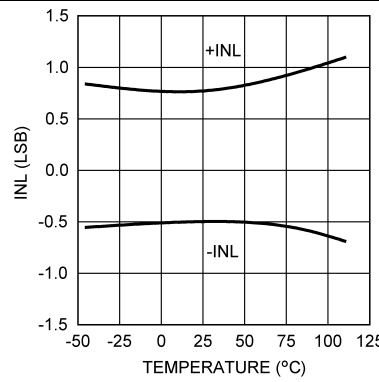

Figure 16. INL vs. Temperature

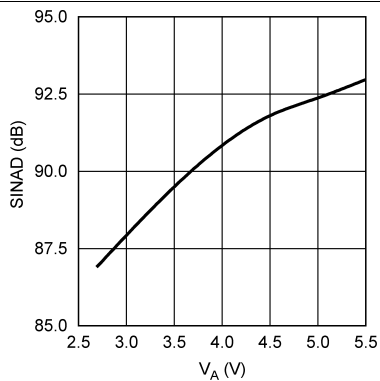

Figure 17. SINAD vs.  $V_A$

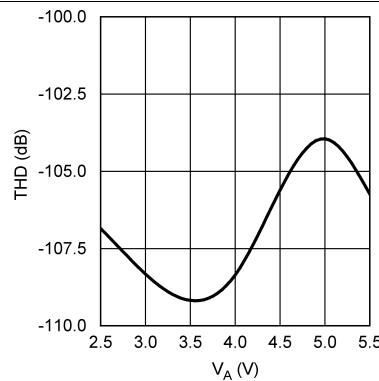

Figure 18. THD vs.  $V_A$

Typical Characteristics (continued)

$V_A = V_{IO} = V_{REF} = 5\text{ V}$ ,  $f_{SCLK} = 5\text{ MHz}$ ,  $f_{SAMPLE} = 250\text{ kSPS}$ ,  $T_A = +25^\circ\text{C}$ , and  $f_{IN} = 20\text{ kHz}$  unless otherwise stated.

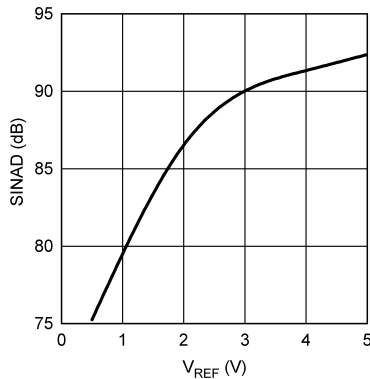

Figure 19. SINAD vs. VREF

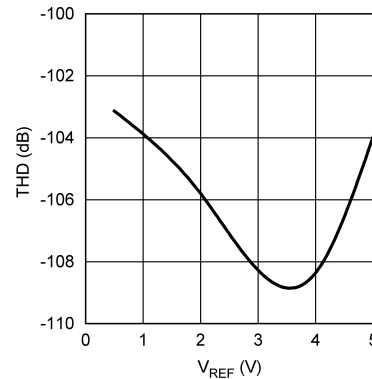

Figure 20. THD vs. VREF

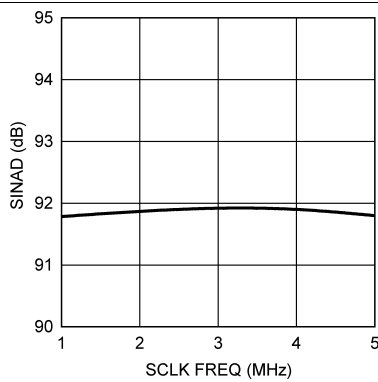

Figure 21. SINAD vs. SCLK Frequency

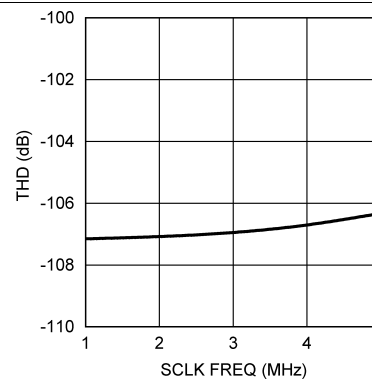

Figure 22. THD vs. SCLK Frequency

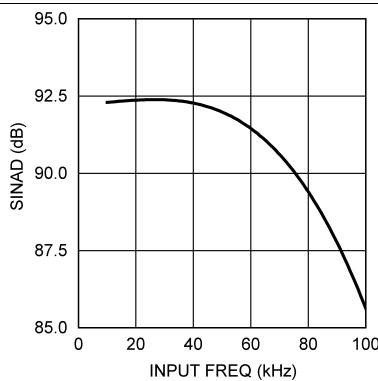

Figure 23. SINAD vs. INPUT Frequency

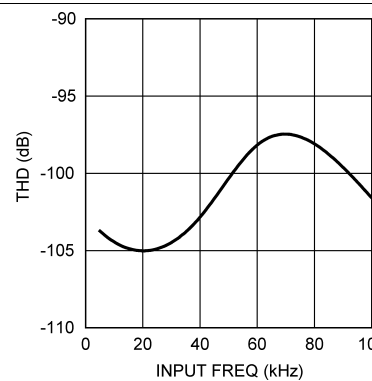
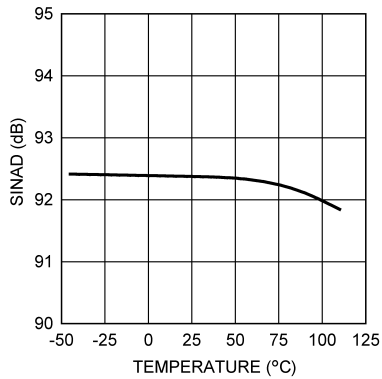
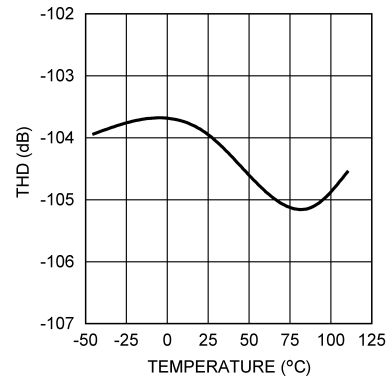
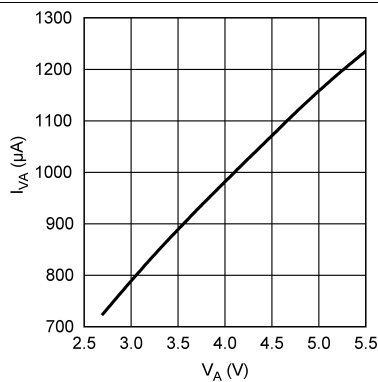
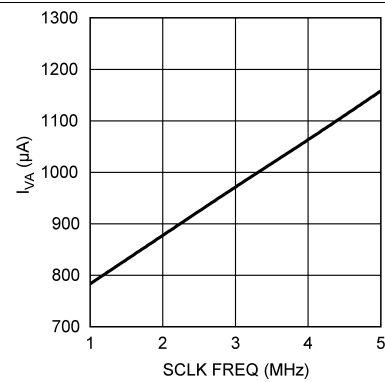
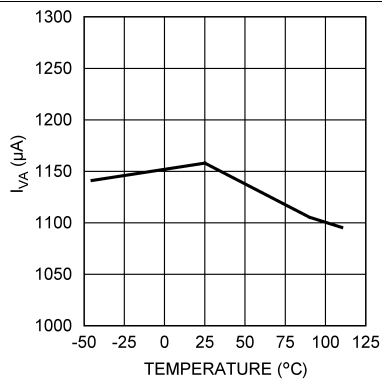
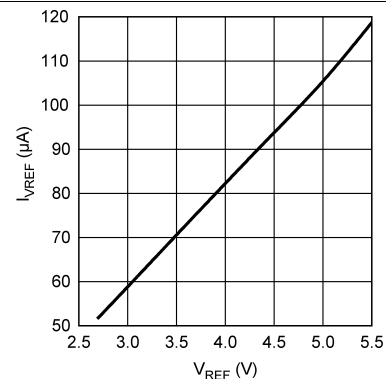

Figure 24. THD vs. INPUT Frequency

**Typical Characteristics (continued)**
 $V_A = V_{IO} = V_{REF} = 5\text{ V}$ ,  $f_{SCLK} = 5\text{ MHz}$ ,  $f_{SAMPLE} = 250\text{ kSPS}$ ,  $T_A = +25^\circ\text{C}$ , and  $f_{IN} = 20\text{ kHz}$  unless otherwise stated.

**Figure 25. SINAD vs. Temperature**

**Figure 26. THD vs. Temperature**

**Figure 27.  $V_A$  Current vs.  $V_A$** 

**Figure 28.  $V_A$  Current vs. SCLK Frequency**

**Figure 29.  $V_A$  Current vs. Temperature**

**Figure 30.  $V_{REF}$  Current vs.  $V_{REF}$**

Typical Characteristics (continued)

$V_A = V_{IO} = V_{REF} = 5\text{ V}$ ,  $f_{SCLK} = 5\text{ MHz}$ ,  $f_{SAMPLE} = 250\text{ kSPS}$ ,  $T_A = +25^\circ\text{C}$ , and  $f_{IN} = 20\text{ kHz}$  unless otherwise stated.

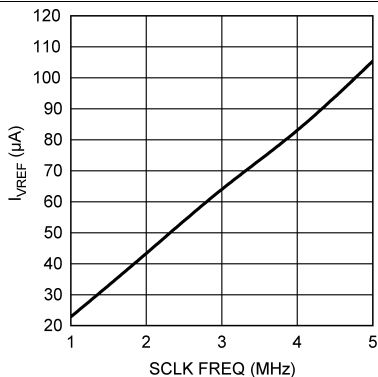

Figure 31.  $V_{REF}$  Current vs. SCLK Frequency

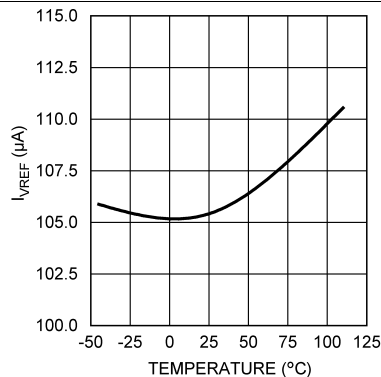

Figure 32.  $V_{REF}$  Current vs. Temperature

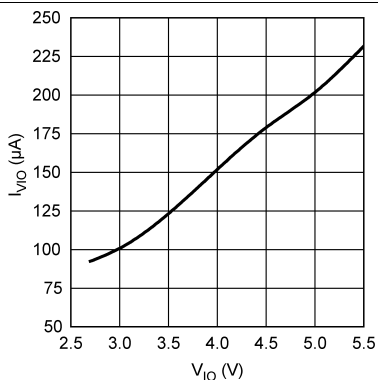

Figure 33.  $V_{IO}$  Current vs.  $V_{IO}$

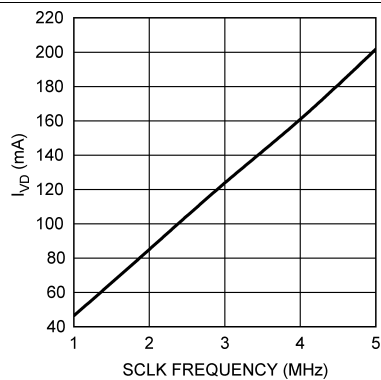

Figure 34.  $V_{IO}$  Current vs. SCLK Frequency

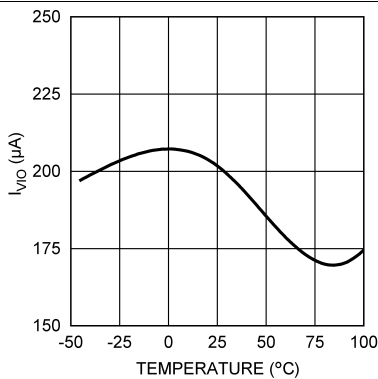

Figure 35.  $V_{IO}$  Current vs. Temperature

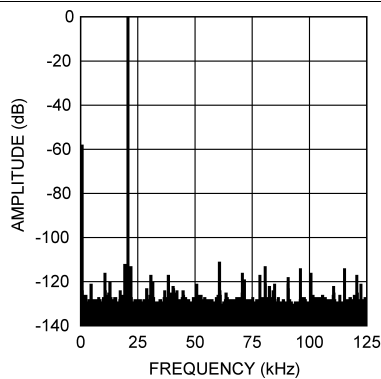

Figure 36. Spectral Response - 250 kSPS

# ADC161S626

SNAS468D – SEPTEMBER 2008 – REVISED DECEMBER 2014

www.ti.com

## Typical Characteristics (continued)

$V_A = V_{IO} = V_{REF} = 5\text{ V}$ ,  $f_{SCLK} = 5\text{ MHz}$ ,  $f_{SAMPLE} = 250\text{ kSPS}$ ,  $T_A = +25^\circ\text{C}$ , and  $f_{IN} = 20\text{ kHz}$  unless otherwise stated.

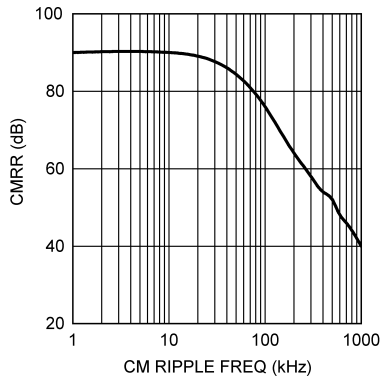

Figure 37. Analog Input CMRR vs. Frequency

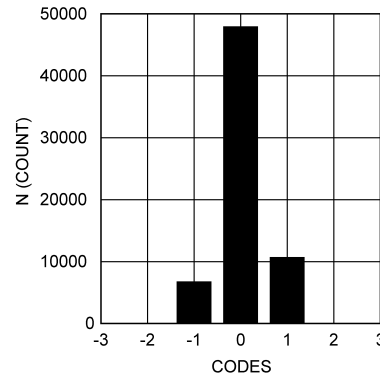

Figure 38. Noise Histogram at Code Center

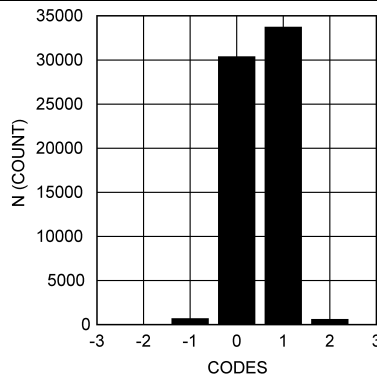

Figure 39. Noise Histogram at Code Transition

## 7 Detailed Description

### 7.1 Overview

The ADC161S626 is a 16-bit, 50 kSPS to 250 kSPS sampling Analog-to-Digital (A/D) converter. The converter uses a successive approximation register (SAR) architecture based upon capacitive redistribution containing an inherent sample-and-hold function. The differential nature of the analog inputs is maintained from the internal sample-and-hold circuits throughout the A/D converter to provide excellent common-mode signal rejection.

The ADC161S626 operates from independent analog and digital supplies. The analog supply ( $V_A$ ) can range from 4.5 V to 5.5 V and the digital input/output supply ( $V_{IO}$ ) can range from 2.7 V to 5.5 V. The ADC161S626 utilizes an external reference ( $V_{REF}$ ), which can be any voltage between 0.5 V and  $V_A$ . The value of  $V_{REF}$  determines the range of the analog input, while the reference input current ( $I_{REF}$ ) depends upon the conversion rate.

The analog input is presented to two input pins: +IN and –IN. Upon initiation of a conversion, the differential input at these pins is sampled on the internal capacitor array. The inputs are disconnected from the internal circuitry while a conversion is in progress. The ADC161S626 features a zero-power track mode (ZPTM) where the ADC is consuming the minimum amount of power (Power-Down Mode) while the internal sampling capacitor array is tracking the applied analog input voltage. The converter enters ZPTM at the end of each conversion window and experiences no delay when the ADC enters into Conversion Mode. This feature allows the user an easy means for optimizing system performance based on the settling capability of the analog source while minimizing power consumption. ZPTM is exercised by bringing chip select bar ( $\overline{CS}$ ) high or when  $\overline{CS}$  is held low after the conversion is complete (after the 18<sup>th</sup> falling edge of the serial clock).

The ADC161S626 communicates with other devices via a Serial Peripheral Interface (SPI), a synchronous serial interface that operates using three pins: chip select bar ( $\overline{CS}$ ), serial clock (SCLK), and serial data out ( $D_{OUT}$ ). The external SCLK controls data transfer and serves as the conversion clock. The duty cycle of SCLK is essentially unimportant, provided the minimum clock high and low times are met. The minimum SCLK frequency is set by internal capacitor leakage. Each conversion requires a minimum of 18 SCLK cycles to complete. If less than 16 bits of conversion data are required,  $\overline{CS}$  can be brought high at any point during the conversion. This procedure of terminating a conversion prior to completion is commonly referred to as short cycling.

The digital conversion result is clocked out by the SCLK input and is provided serially, most significant bit (MSB) first, at the  $D_{OUT}$  pin. The digital data that is provided at the  $D_{OUT}$  pin is that of the conversion currently in progress and thus there is no pipe line delay or latency.

### 7.2 Functional Block Diagram

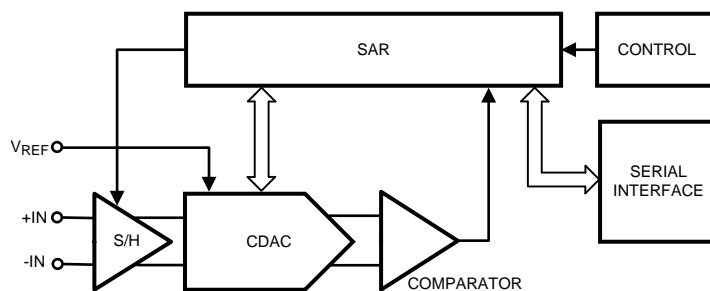

### 7.3 Feature Description

#### 7.3.1 Reference Input ( $V_{REF}$ )

The externally supplied reference voltage ( $V_{REF}$ ) sets the analog input range. The ADC161S626 will operate with  $V_{REF}$  in the range of 0.5 V to  $V_A$ .

Operation with  $V_{REF}$  below 2.5V is possible with slightly diminished performance. As  $V_{REF}$  is reduced, the range of acceptable analog input voltages is reduced. Assuming a proper common-mode input voltage ( $V_{CM}$ ), the differential peak-to-peak input range is limited to  $(2 \times V_{REF})$ .

## Feature Description (continued)

Reducing  $V_{REF}$  also reduces the size of the least significant bit (LSB). For example, the size of one LSB is equal to  $[(2 \times V_{REF}) / 2^n]$ , which is  $152.6 \mu\text{V}$  where  $n$  is 16 bits and  $V_{REF}$  is 5V. When the LSB size goes below the noise floor of the ADC161S626, the noise will span an increasing number of codes and overall performance will suffer. Dynamic signals will have their SNR degrade; while, D.C. measurements will have their code uncertainty increase. Since the noise is Gaussian in nature, the effects of this noise can be reduced by averaging the results of a number of consecutive conversions.

$V_{REF}$  and analog inputs (+IN and -IN) are connected to the capacitor array through a switch matrix when the input is sampled. Hence,  $I_{REF}$ ,  $I_{+IN}$ , and  $I_{-IN}$  are a series of transient spikes that occur at a frequency dependent on the operating sample rate of the ADC161S626.

$I_{REF}$  changes only slightly with temperature. See the curves, “Reference Current vs. SCLK Frequency” and “Reference Current vs. Temperature” in the [Typical Characteristics](#) section for additional details.

### 7.3.2 Sample and Hold

The ADC161S626 has a differential input where the effective input voltage that is digitized is (+IN) – (–IN).

#### 7.3.2.1 Input Settling

When the ADC161S626 enters acquisition ( $t_{ACQ}$ ) mode at the end of the conversion window, the internal sampling capacitor ( $C_{SAMPLE}$ ) is connected to the ADC input via an internal switch and a series resistor ( $R_{SAMPLE}$ ), as shown in [Figure 40](#). Typical values for  $C_{SAMPLE}$  and  $R_{SAMPLE}$  are 20 pF and 200 ohms respectively. If there is not a large external capacitor ( $C_{EXT}$ ) at the analog input of the ADC, a voltage spike will be observed at the input pins. This is a result of  $C_{SAMPLE}$  and  $C_{EXT}$  being at different voltage potentials. The magnitude and direction of the voltage spike depend on the difference between the voltage of  $C_{SAMPLE}$  and  $C_{EXT}$ . If the voltage at  $C_{SAMPLE}$  is greater than the voltage at  $C_{EXT}$ , a positive voltage spike will occur. If the opposite is true, a negative voltage spike will occur. It is not critical for the performance of the ADC161S626 to filter out the voltage spike. Rather, ensure that the transient of the spike settles out within  $t_{ACQ}$ .

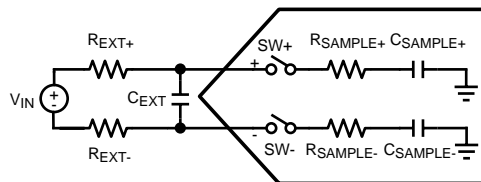

**Figure 40. ADC Input Capacitors**

### 7.3.3 Serial Digital Interface

The ADC161S626 communicates via a synchronous 3-wire serial interface as shown in [Figure 1](#) or re-shown in [Figure 41](#) for convenience.  $\overline{CS}$ , chip select bar, initiates conversions and frames the serial data transfers. SCLK (serial clock) controls both the conversion process and the timing of the serial data.  $D_{OUT}$  is the serial data output pin, where a conversion result is sent as a serial data stream, MSB first.

A serial frame is initiated on the falling edge of  $\overline{CS}$  and ends on the rising edge of  $\overline{CS}$ . The ADC161S626's  $D_{OUT}$  pin is in a high impedance state when  $\overline{CS}$  is high and for the first clock period after  $\overline{CS}$  is asserted;  $D_{OUT}$  is active for the remainder of time when  $\overline{CS}$  is asserted.

The ADC161S626 samples the differential input upon the assertion of  $\overline{CS}$ . Assertion is defined as bringing the  $\overline{CS}$  pin to a logic low state. For the first 17 periods of the SCLK following the assertion of  $\overline{CS}$ , the ADC161S626 is converting the analog input voltage. On the 18<sup>th</sup> falling edge of SCLK, the ADC161S626 enters acquisition ( $t_{ACQ}$ ) mode. For the next three periods of SCLK, the ADC161S626 is operating in acquisition mode where the ADC input is tracking the analog input signal applied across +IN and -IN. During acquisition mode, the ADC161S626 is consuming a minimal amount of power.



## Feature Description (continued)

The ADC161S626 can enter conversion mode ( $t_{CONV}$ ) under three different conditions. The first condition involves  $\overline{CS}$  going low (asserted) with SCLK high. In this case, the ADC161S626 enters conversion mode on the first falling edge of SCLK after  $\overline{CS}$  is asserted. In the second condition,  $\overline{CS}$  goes low with SCLK low. Under this condition, the ADC161S626 automatically enters conversion mode and the falling edge of  $\overline{CS}$  is seen as the first falling edge of SCLK. In the third condition,  $\overline{CS}$  and SCLK go low simultaneously and the ADC161S626 enters conversion mode. While there is no timing restriction with respect to the falling edges of  $\overline{CS}$  and SCLK, there are minimum setup and hold time requirements for the falling edge of  $\overline{CS}$  with respect to the rising edge of SCLK. See [Figure 5](#) in the *Timing Requirements* section for more information.

### 7.3.3.1 $\overline{CS}$ Input

The  $\overline{CS}$  (chip select bar) input is active low and is CMOS compatible. The ADC161S626 enters conversion mode when  $\overline{CS}$  is asserted and the SCLK pin is in a logic low state. When  $\overline{CS}$  is high, the ADC161S626 is always in acquisition mode and thus consuming the minimum amount of power. Since  $\overline{CS}$  must be asserted to begin a conversion, the sample rate of the ADC161S626 is equal to the assertion rate of  $\overline{CS}$ .

Proper operation requires that the fall of  $\overline{CS}$  not occur simultaneously with a rising edge of SCLK. If the fall of  $\overline{CS}$  occurs during the rising edge of SCLK, the data might be clocked out one bit early. Whether or not the data is clocked out early depends upon how close the  $\overline{CS}$  transition is to the SCLK transition, the device temperature, and the characteristics of the individual device. To ensure that the MSB is always clocked out at a given time (the 3<sup>rd</sup> falling edge of SCLK), it is essential that the fall of  $\overline{CS}$  always meet the timing requirement specified in the *Timing Requirements* table.

### 7.3.3.2 SCLK Input

The SCLK (serial clock) is used as the conversion clock to shift out the conversion result. SCLK is CMOS compatible. Internal settling time requirements limit the maximum clock frequency while internal capacitor leakage limits the minimum clock frequency. The ADC161S626 offers ensured performance with the clock rates indicated in the electrical table.

The ADC161S626 enters acquisition mode on the 18<sup>th</sup> falling edge of SCLK during a conversion frame. Assuming that the LSB is clocked into a controller on the 18<sup>th</sup> rising edge of SCLK, there is a minimum acquisition time period that must be met before a new conversion frame can begin. Other than the 18<sup>th</sup> rising edge of SCLK that was used to latch the LSB into a controller, there is no requirement for the SCLK to transition during acquisition mode. Therefore, it is acceptable to idle SCLK after the LSB has been latched into the controller.

### 7.3.3.3 Data Output

The data output format of the ADC161S626 is two's complement as shown in [Figure 42](#). This figure indicates the ideal output code for a given input voltage and does not include the effects of offset, gain error, linearity errors, or noise. Each data output bit is output on the falling edges of SCLK.  $D_{OUT}$  is in a high impedance state for the 1<sup>st</sup> falling edge of SCLK while the 2<sup>nd</sup> SCLK falling edge clocks out a leading zero. The 3<sup>rd</sup> to 18<sup>th</sup> SCLK falling edges clock out the conversion result, MSB first.

While most receiving systems will capture the digital output bits on the rising edges of SCLK, the falling edges of SCLK may be used to capture the conversion result if the minimum hold time for  $D_{OUT}$  is acceptable. See [Figure 4](#) for  $D_{OUT}$  hold ( $t_{DH}$ ) and access ( $t_{DA}$ ) times.

$D_{OUT}$  is enabled on the second falling edge of SCLK after the assertion of  $\overline{CS}$  and is disabled on the rising edge of  $\overline{CS}$ . If  $\overline{CS}$  is raised prior to the 18<sup>th</sup> falling edge of SCLK, the current conversion is aborted and  $D_{OUT}$  will go into its high impedance state. A new conversion will begin when  $\overline{CS}$  is driven LOW.

## Feature Description (continued)

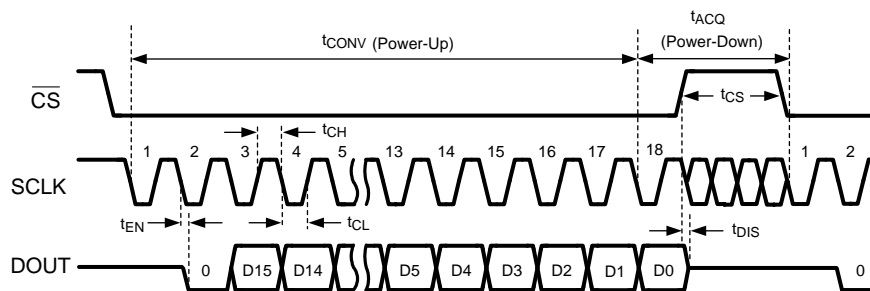

Figure 41. ADC161S626 Single Conversion Timing Diagram

## 7.4 Device Functional Modes

### 7.4.1 Differential Input Operation

The transfer curve of the ADC161S626 for a fully differential input signal is shown in Figure 42. A positive full scale output code (0111 1111 1111 1111b or 7FFFh or 32,767d) will be obtained when  $(+IN) - (-IN)$  is greater than or equal to  $(V_{REF} - 1 \text{ LSB})$ . A negative full scale code (1000 0000 0000 0000b or 8000h or -32,768d) will be obtained when  $[(+IN) - (-IN)]$  is less than or equal to  $(-V_{REF} + 1 \text{ LSB})$ . This ignores gain, offset and linearity errors, which will affect the exact differential input voltage that will determine any given output code.

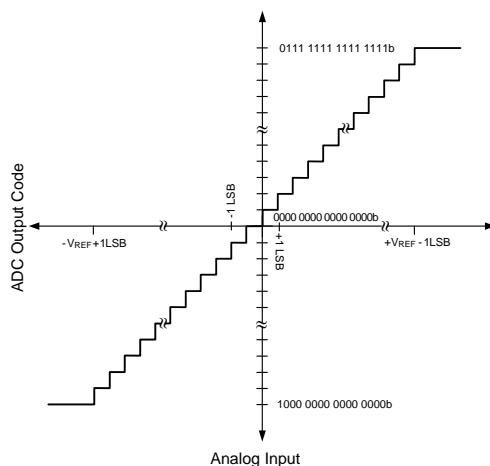

Figure 42. ADC Transfer Curve

Both inputs should be biased at a common mode voltage ( $V_{CM}$ ), which will be thoroughly discussed in Figure 43 shows the ADC161S626 being driven by a full-scale differential source.

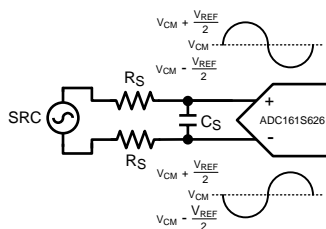

Figure 43. Differential Input

## Device Functional Modes (continued)

The allowable input common mode voltage ( $V_{CM}$ ) range depends upon  $V_A$  and  $V_{REF}$  used for the ADC161S626. The ranges of  $V_{CM}$  are depicted in Figure 44 and Figure 46. Note that these figures only apply to a  $V_A$  of 5V. Equations for calculating the minimum and maximum  $V_{CM}$  for differential and single-ended operations are shown in Figure 44.

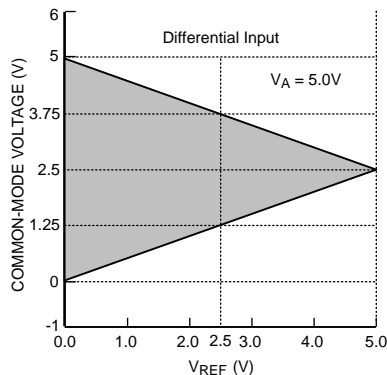

Figure 44.  $V_{CM}$  range for Differential Input operation

### 7.4.2 Single-Ended Input Operation

For single-ended operation, the non-inverting input (+IN) of the ADC161S626 can be driven with a signal that has a peak-to-peak range that is equal to or less than  $(2 \times V_{REF})$ . The inverting input (-IN) should be biased at a stable  $V_{CM}$  that is halfway between these maximum and minimum values. In order to utilize the entire dynamic range of the ADC161S626,  $V_{REF}$  is limited to  $(V_A / 2)$ . This allows +IN a maximum swing range of ground to  $V_A$ . Figure 45 shows the ADC161S626 being driven by a full-scale single-ended source.

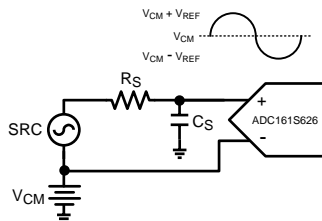

Figure 45. Single-Ended Input

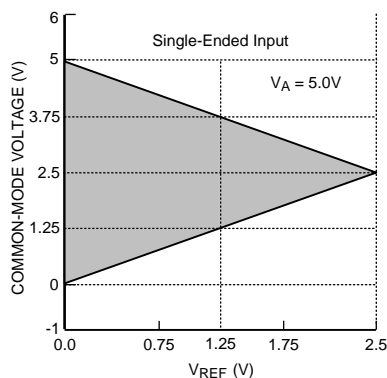
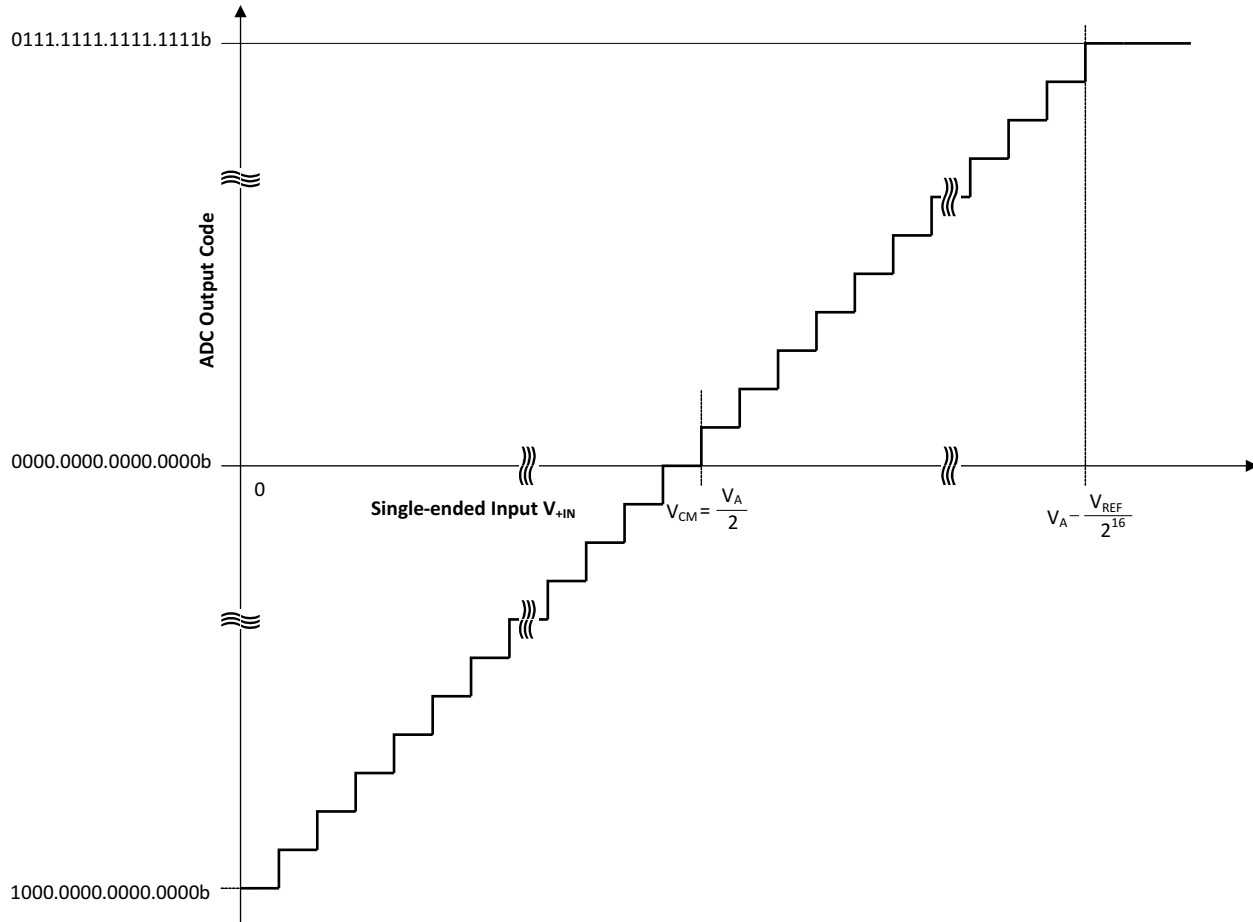

Figure 46.  $V_{CM}$  Range for single-Ended Operation

## Device Functional Modes (continued)

Since the design of the ADC161S626 is optimized for a differential input, the performance degrades slightly when driven with a single-ended input. Linearity characteristics such as INL and DNL typically degrade by 0.1 LSB and dynamic characteristics such as SINAD typically degrade by 2 dB. Note that single-ended operation should only be used if the performance degradation (compared with differential operation) is acceptable.



**Figure 47. Single-Ended Transfer Characteristic**

### 7.4.3 Short Cycling

Short cycling refers to the process of halting a conversion after the last needed bit is outputted. Short cycling can be used to lower the power consumption in those applications that do not need a full 16-bit resolution, or where an analog signal is being monitored until some condition occurs. In some circumstances, the conversion could be terminated after the first few bits. This will lower power consumption in the converter since the ADC161S626 spends more time in acquisition mode and less time in conversion mode.

Short cycling is accomplished by pulling  $\overline{CS}$  high after the last required bit is received from the ADC161S626 output. This is possible because the ADC161S626 places the latest converted data bit on  $D_{OUT}$  as it is generated. If only 10-bits of the conversion result are needed, for example, the conversion can be terminated by pulling  $\overline{CS}$  high after the 10<sup>th</sup> bit has been clocked out.

## Device Functional Modes (continued)

### 7.4.4 Burst Mode Operation

Normal operation of the ADC161S626 requires the SCLK frequency to be 20 times the sample rate and the  $\overline{CS}$  rate to be the same as the sample rate. However, in order to minimize power consumption in applications requiring sample rates below 250 kSPS, the ADC161S626 should be run with an SCLK frequency of 5 MHz and a  $\overline{CS}$  rate as slow as the system requires. When this is accomplished, the ADC161S626 is operating in burst mode. The ADC161S626 enters into acquisition mode at the end of each conversion, minimizing power consumption. This causes the converter to spend the longest possible time in acquisition mode. Since power consumption scales directly with conversion rate, minimizing power consumption requires determining the lowest conversion rate that will satisfy the requirements of the system.



**Typical Application (continued)**

$$\frac{1}{2\pi \times R \times C} \leq \frac{F_s}{2} \tag{2}$$

$$R \times C \geq \frac{1}{\pi \times F_s} \tag{3}$$

With  $F_s = 250$  kHz, a good choice for the single pole filter is:

$R = 100$

$C = 33$  nF

This reduces the input  $BW_{\text{signal}} = 48$  kHz.

The capacitor at the inputs of the device provides not only the filtering of the input signal, but it also absorbs the charge kick-back from the ADC. The kick-back is the result of the internal switches opening at the end of the acquisition period.

The common mode level of the ADC inputs has to be set by the external bias source. The VCM bias has to be isolated from the inputs by a large resistance in order to avoid input signal attenuation.

The VA and VIO sources are already separated in this example, due to the design requirements. This also benefits the overall performance of the ADC, as the potentially noisy VIO supply does not contaminate the VA. In the same vein, further consideration could be given to the SPI interface, especially when the master MCU is capable of producing fast rising edges on the digital bus signals. Inserting small resistances in the digital signal path may help in reducing the ground bounce, and thus improve the overall noise performance of the system.

**8.2.3 Application Curve**

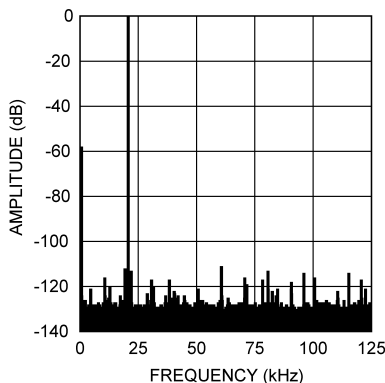

**Figure 49. Spectral Response**

## 9 Power Supply Recommendations

### 9.1 Analog and Digital Power Supplies

Any ADC architecture is sensitive to spikes on the power supply, reference, and ground pins. These spikes may originate from switching power supplies, digital logic, high power devices, and other sources. Power to the ADC161S626 should be clean and well bypassed. A 0.1  $\mu\text{F}$  ceramic bypass capacitor and a 1  $\mu\text{F}$  to 10  $\mu\text{F}$  capacitor should be used to bypass the ADC161S626 supply, with the 0.1  $\mu\text{F}$  capacitor placed as close to the ADC161S626 package as possible.

Since the ADC161S626 has both the  $V_A$  and  $V_{IO}$  pins, the user has three options on how to connect these pins. The first option is to tie  $V_A$  and  $V_{IO}$  together and power them with the same power supply. This is the most cost effective way of powering the ADC161S626 but is also the least ideal. As stated previously, noise from  $V_{IO}$  can couple into  $V_A$  and adversely affect performance. The other two options involve the user powering  $V_A$  and  $V_{IO}$  with separate supply voltages. These supply voltages can have the same amplitude or they can be different.  $V_A$  can be set to any value between +4.5V and +5.5V; while  $V_{IO}$  can be set to any value between +2.7V and +5.5V.

Best performance will typically be achieved with  $V_A$  operating at 5V and  $V_{IO}$  at 3V. Operating  $V_A$  at 5V offers the best linearity and dynamic performance when  $V_{REF}$  is also set to 5V; while operating  $V_{IO}$  at 3V reduces the power consumption of the digital logic. Operating the digital interface at 3V also has the added benefit of decreasing the noise created by charging and discharging the capacitance of the digital interface pins.

### 9.2 Voltage Reference

The reference source must have a low output impedance and needs to be bypassed with a minimum capacitor value of 0.1  $\mu\text{F}$ . A larger capacitor value of 1  $\mu\text{F}$  to 10  $\mu\text{F}$  placed in parallel with the 0.1  $\mu\text{F}$  is preferred. While the ADC161S626 draws very little current from the reference on average, there are higher instantaneous current spikes at the reference.

$V_{REF}$  of the ADC161S626, like all A/D converters, does not reject noise or voltage variations. Keep this in mind if  $V_{REF}$  is derived from the power supply. Any noise and/or ripple from the supply that is not rejected by the external reference circuitry will appear in the digital results. The use of an active reference source is recommended. The LM4040 and LM4050 shunt reference families and the LM4120 and LM4140 series reference families are excellent choices for a reference source.

## 10 Layout

### 10.1 Layout Guidelines

Capacitive coupling between the noisy digital circuitry and the sensitive analog circuitry can lead to poor performance. The solution is to keep the analog circuitry separated from the digital circuitry and the clock line as short as possible. Digital circuits create substantial supply and ground current transients. The logic noise generated could have significant impact upon system noise performance. To avoid performance degradation of the ADC161S626 due to supply noise, avoid using the same supply for the  $V_A$  and  $V_{REF}$  of the ADC161S626 that is used for digital circuitry on the board.

Generally, analog and digital lines should cross each other at 90° to avoid crosstalk. However, to maximize accuracy in high resolution systems, avoid crossing analog and digital lines altogether. It is important to keep clock lines as short as possible and isolated from ALL other lines, including other digital lines. In addition, the clock line should also be treated as a transmission line and be properly terminated. The analog input should be isolated from noisy signal traces to avoid coupling of spurious signals into the input. Any external component (e.g., a filter capacitor) connected between the converter's input pins and ground or to the reference input pin and ground should be connected to a very clean point in the ground plane.

A single, uniform ground plane and the use of split power planes are recommended. The power planes should be located within the same board layer. All analog circuitry (input amplifiers, filters, reference components, etc.) should be placed over the analog power plane. All digital circuitry should be placed over the digital power plane. Furthermore, the GND pins on the ADC161S626 and all the components in the reference circuitry and input signal chain that are connected to ground should be connected to the ground plane at a quiet point. Avoid connecting these points too close to the ground point of a microprocessor, microcontroller, digital signal processor, or other high power digital device.



## Layout Guidelines (continued)

For best performance, care should be taken with the physical layout of the printed circuit board. This is especially true with a low  $V_{REF}$  or when the conversion rate is high. At high clock rates there is less time for settling, so it is important that any noise settles out before the conversion begins.

### 10.2 Layout Example

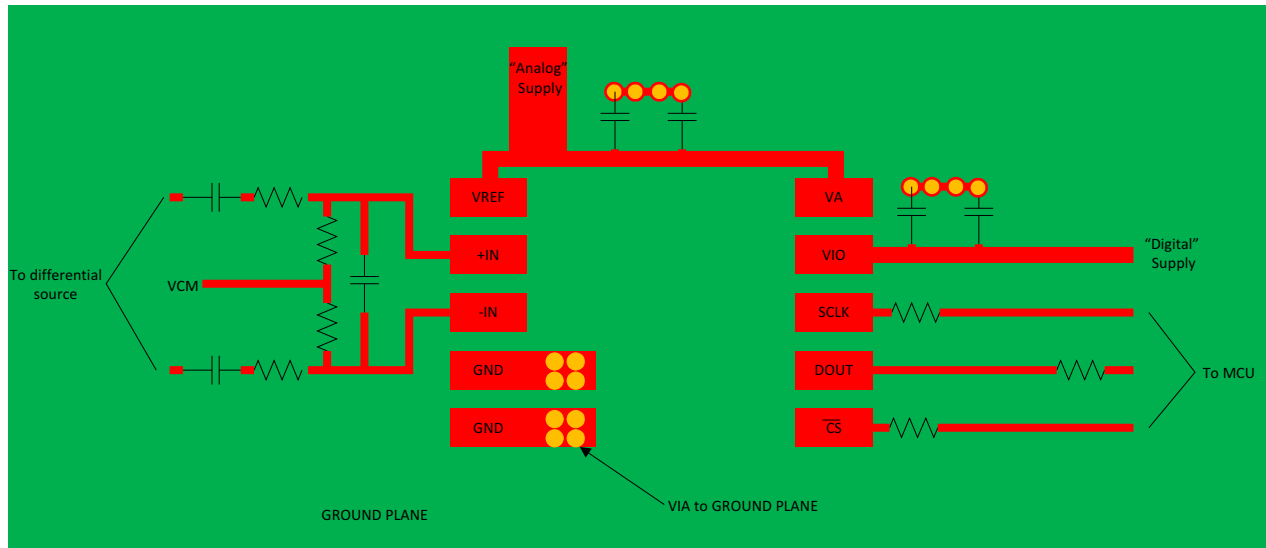

Figure 50. PCB Layout Example

## 11 Device and Documentation Support

### 11.1 Device Support

#### 11.1.1 Specification Definitions

**APERTURE DELAY** is the time between the first falling edge of SCLK and the time when the input signal is sampled for conversion.

**COMMON MODE REJECTION RATIO (CMRR)** is a measure of how well in-phase signals common to both input pins are rejected.

To calculate CMRR, the change in output offset is measured while the common mode input voltage is changed from 2V to 3V.

$$\text{CMRR} = 20 \text{ LOG} (\Delta \text{ Common Input} / \Delta \text{ Output Offset}) \quad (4)$$

**CONVERSION TIME** is the time required, after the input voltage is acquired, for the ADC to convert the input voltage to a digital word.

**DIFFERENTIAL NON-LINEARITY (DNL)** is the measure of the maximum deviation from the ideal step size of 1 LSB.

**DUTY CYCLE** is the ratio of the time that a repetitive digital waveform is high to the total time of one period. The specification here refers to the SCLK.

**EFFECTIVE NUMBER OF BITS (ENOB, or EFFECTIVE BITS)** is another method of specifying Signal-to-Noise and Distortion or SINAD. ENOB is defined as  $(\text{SINAD} - 1.76) / 6.02$  and says that the converter is equivalent to a perfect ADC of this (ENOB) number of bits.

**FULL POWER BANDWIDTH** is a measure of the frequency at which the reconstructed output fundamental drops 3 dB below its low frequency value for a full scale input.

**GAIN ERROR** is the deviation from the ideal slope of the transfer function. It is the difference between Positive Full-Scale Error and Negative Full-Scale Error and can be calculated as:

$$\text{Gain Error} = \text{Positive Full-Scale Error} - \text{Negative Full-Scale Error} \quad (5)$$

**INTEGRAL NON-LINEARITY (INL)** is a measure of the deviation of each individual code from a line drawn from  $\frac{1}{2}$  LSB below the first code transition through  $\frac{1}{2}$  LSB above the last code transition. The deviation of any given code from this straight line is measured from the center of that code value.

**MISSING CODES** are those output codes that will never appear at the ADC outputs. The ADC161S626 is ensured not to have any missing codes.

**NEGATIVE FULL-SCALE ERROR** is the difference between the differential input voltage at which the output code transitions from code 0x8001h to 0x8000h and  $-V_{\text{REF}} + 1 \text{ LSB}$ .

**NEGATIVE GAIN ERROR** is the difference between the negative full-scale error and the offset error.

**OFFSET ERROR** is the difference between the differential input voltage at which the output code transitions from code 0x0000h to 0x0001h and 1 LSB.

**POSITIVE FULL-SCALE ERROR** is the difference between the differential input voltage at which the output code transitions from code 0xFFFFh to 0xFFFEh and  $V_{\text{REF}} - 1 \text{ LSB}$ .

**POSITIVE GAIN ERROR** is the difference between the positive full-scale error and the offset error.

**POWER SUPPLY REJECTION RATIO (PSRR)** is a measure of how well a change in the analog supply voltage is rejected. PSRR is calculated from the ratio of the change in offset error for a given change in supply voltage, expressed in dB. For the ADC161S626,  $V_A$  is changed from 4.5V to 5.5V.

$$\text{PSRR} = 20 \text{ LOG} (\Delta \text{Output Offset} / \Delta V_A) \quad (6)$$

**SIGNAL TO NOISE PLUS DISTORTION (S/N+D or SINAD)** is the ratio, expressed in dB, of the rms value of the input signal to the rms value of all of the other spectral components below one-half the sampling frequency, including harmonics but excluding d.c.

**SIGNAL TO NOISE RATIO (SNR)** is the ratio, expressed in dB, of the rms value of the input signal to the rms value of the sum of all other spectral components below one-half the sampling frequency, not

## Device Support (continued)

including harmonics or d.c.

**SPURIOUS FREE DYNAMIC RANGE (SFDR)** is the difference, expressed in dB, between the desired signal amplitude to the amplitude of the peak spurious spectral component below one-half the sampling frequency, where a spurious spectral component is any signal present in the output spectrum that is not present at the input and may or may not be a harmonic.

**THROUGHPUT TIME** is the minimum time required between the start of two successive conversion.

**TOTAL HARMONIC DISTORTION (THD)** is the ratio of the rms total of the first five harmonic components at the output to the rms level of the input signal frequency as seen at the output, expressed in dB. THD is calculated as

$$\text{THD} = 20 \times \log_{10} \sqrt{\frac{A_{f_2}^2 + \dots + A_{f_6}^2}{A_{f_1}^2}}$$

where

- $A_{f_1}$  is the RMS power of the input frequency at the output
- $A_{f_2}$  through  $A_{f_6}$  are the RMS power in the first 5 harmonic frequencies. (7)

## 11.2 Trademarks

QSPI is a trademark of Motorola.

MICROWIRE is a trademark of National Semiconductor Corp.

All other trademarks are the property of their respective owners.

## 11.3 Electrostatic Discharge Caution



These devices have limited built-in ESD protection. The leads should be shorted together or the device placed in conductive foam during storage or handling to prevent electrostatic damage to the MOS gates.

## 11.4 Glossary

[SLYZ022](#) — *TI Glossary*.

This glossary lists and explains terms, acronyms, and definitions.

## 12 Mechanical, Packaging, and Orderable Information

The following pages include mechanical, packaging, and orderable information. This information is the most current data available for the designated devices. This data is subject to change without notice and revision of this document. For browser-based versions of this data sheet, refer to the left-hand navigation.

## PACKAGING INFORMATION

Orderable Device	Status (1)	Package Type	Package Drawing	Pins	Package Qty	Eco Plan (2)	Lead/Ball Finish (6)	MSL Peak Temp (3)	Op Temp (°C)	Device Marking (4/5)	Samples
ADC161S626CIMM/NOPB	ACTIVE	VSSOP	DGS	10	1000	Green (RoHS & no Sb/Br)	CU SN	Level-1-260C-UNLIM	-40 to 85	X98C	<a href="#">Samples</a>
ADC161S626CIMME/NOPB	ACTIVE	VSSOP	DGS	10	250	Green (RoHS & no Sb/Br)	CU SN	Level-1-260C-UNLIM	-40 to 85	X98C	<a href="#">Samples</a>
ADC161S626CIMMX/NOPB	ACTIVE	VSSOP	DGS	10	3500	Green (RoHS & no Sb/Br)	CU SN	Level-1-260C-UNLIM	-40 to 85	X98C	<a href="#">Samples</a>

(1) The marketing status values are defined as follows:

**ACTIVE:** Product device recommended for new designs.

**LIFEBUY:** TI has announced that the device will be discontinued, and a lifetime-buy period is in effect.

**NRND:** Not recommended for new designs. Device is in production to support existing customers, but TI does not recommend using this part in a new design.

**PREVIEW:** Device has been announced but is not in production. Samples may or may not be available.

**OBSOLETE:** TI has discontinued the production of the device.

(2) Eco Plan - The planned eco-friendly classification: Pb-Free (RoHS), Pb-Free (RoHS Exempt), or Green (RoHS & no Sb/Br) - please check <http://www.ti.com/productcontent> for the latest availability information and additional product content details.

**TBD:** The Pb-Free/Green conversion plan has not been defined.

**Pb-Free (RoHS):** TI's terms "Lead-Free" or "Pb-Free" mean semiconductor products that are compatible with the current RoHS requirements for all 6 substances, including the requirement that lead not exceed 0.1% by weight in homogeneous materials. Where designed to be soldered at high temperatures, TI Pb-Free products are suitable for use in specified lead-free processes.

**Pb-Free (RoHS Exempt):** This component has a RoHS exemption for either 1) lead-based flip-chip solder bumps used between the die and package, or 2) lead-based die adhesive used between the die and leadframe. The component is otherwise considered Pb-Free (RoHS compatible) as defined above.

**Green (RoHS & no Sb/Br):** TI defines "Green" to mean Pb-Free (RoHS compatible), and free of Bromine (Br) and Antimony (Sb) based flame retardants (Br or Sb do not exceed 0.1% by weight in homogeneous material)

(3) MSL, Peak Temp. - The Moisture Sensitivity Level rating according to the JEDEC industry standard classifications, and peak solder temperature.

(4) There may be additional marking, which relates to the logo, the lot trace code information, or the environmental category on the device.

(5) Multiple Device Markings will be inside parentheses. Only one Device Marking contained in parentheses and separated by a "~" will appear on a device. If a line is indented then it is a continuation of the previous line and the two combined represent the entire Device Marking for that device.

(6) Lead/Ball Finish - Orderable Devices may have multiple material finish options. Finish options are separated by a vertical ruled line. Lead/Ball Finish values may wrap to two lines if the finish value exceeds the maximum column width.

**Important Information and Disclaimer:** The information provided on this page represents TI's knowledge and belief as of the date that it is provided. TI bases its knowledge and belief on information provided by third parties, and makes no representation or warranty as to the accuracy of such information. Efforts are underway to better integrate information from third parties. TI has taken and

continues to take reasonable steps to provide representative and accurate information but may not have conducted destructive testing or chemical analysis on incoming materials and chemicals. TI and TI suppliers consider certain information to be proprietary, and thus CAS numbers and other limited information may not be available for release.

In no event shall TI's liability arising out of such information exceed the total purchase price of the TI part(s) at issue in this document sold by TI to Customer on an annual basis.

## TAPE AND REEL INFORMATION



### QUADRANT ASSIGNMENTS FOR PIN 1 ORIENTATION IN TAPE



\*All dimensions are nominal

Device	Package Type	Package Drawing	Pins	SPQ	Reel Diameter (mm)	Reel Width W1 (mm)	A0 (mm)	B0 (mm)	K0 (mm)	P1 (mm)	W (mm)	Pin1 Quadrant
ADC161S626CIMM/NOPB	VSSOP	DGS	10	1000	178.0	12.4	5.3	3.4	1.4	8.0	12.0	Q1
ADC161S626CIMME/NOPB	VSSOP	DGS	10	250	178.0	12.4	5.3	3.4	1.4	8.0	12.0	Q1
ADC161S626CIMMX/NOPB	VSSOP	DGS	10	3500	330.0	12.4	5.3	3.4	1.4	8.0	12.0	Q1

**TAPE AND REEL BOX DIMENSIONS**

\*All dimensions are nominal

Device	Package Type	Package Drawing	Pins	SPQ	Length (mm)	Width (mm)	Height (mm)
ADC161S626CIMM/NOPB	VSSOP	DGS	10	1000	210.0	185.0	35.0
ADC161S626CIMME/NOPB	VSSOP	DGS	10	250	210.0	185.0	35.0
ADC161S626CIMMX/NOPB	VSSOP	DGS	10	3500	367.0	367.0	35.0

DGS (S-PDSO-G10)

PLASTIC SMALL-OUTLINE PACKAGE



- NOTES:
- A. All linear dimensions are in millimeters.
  - B. This drawing is subject to change without notice.
  - C. Body dimensions do not include mold flash or protrusion.
  - D. Falls within JEDEC MO-187 variation BA.



## IMPORTANT NOTICE

Texas Instruments Incorporated and its subsidiaries (TI) reserve the right to make corrections, enhancements, improvements and other changes to its semiconductor products and services per JESD46, latest issue, and to discontinue any product or service per JESD48, latest issue. Buyers should obtain the latest relevant information before placing orders and should verify that such information is current and complete. All semiconductor products (also referred to herein as "components") are sold subject to TI's terms and conditions of sale supplied at the time of order acknowledgment.

TI warrants performance of its components to the specifications applicable at the time of sale, in accordance with the warranty in TI's terms and conditions of sale of semiconductor products. Testing and other quality control techniques are used to the extent TI deems necessary to support this warranty. Except where mandated by applicable law, testing of all parameters of each component is not necessarily performed.

TI assumes no liability for applications assistance or the design of Buyers' products. Buyers are responsible for their products and applications using TI components. To minimize the risks associated with Buyers' products and applications, Buyers should provide adequate design and operating safeguards.

TI does not warrant or represent that any license, either express or implied, is granted under any patent right, copyright, mask work right, or other intellectual property right relating to any combination, machine, or process in which TI components or services are used. Information published by TI regarding third-party products or services does not constitute a license to use such products or services or a warranty or endorsement thereof. Use of such information may require a license from a third party under the patents or other intellectual property of the third party, or a license from TI under the patents or other intellectual property of TI.

Reproduction of significant portions of TI information in TI data books or data sheets is permissible only if reproduction is without alteration and is accompanied by all associated warranties, conditions, limitations, and notices. TI is not responsible or liable for such altered documentation. Information of third parties may be subject to additional restrictions.

Resale of TI components or services with statements different from or beyond the parameters stated by TI for that component or service voids all express and any implied warranties for the associated TI component or service and is an unfair and deceptive business practice. TI is not responsible or liable for any such statements.

Buyer acknowledges and agrees that it is solely responsible for compliance with all legal, regulatory and safety-related requirements concerning its products, and any use of TI components in its applications, notwithstanding any applications-related information or support that may be provided by TI. Buyer represents and agrees that it has all the necessary expertise to create and implement safeguards which anticipate dangerous consequences of failures, monitor failures and their consequences, lessen the likelihood of failures that might cause harm and take appropriate remedial actions. Buyer will fully indemnify TI and its representatives against any damages arising out of the use of any TI components in safety-critical applications.

In some cases, TI components may be promoted specifically to facilitate safety-related applications. With such components, TI's goal is to help enable customers to design and create their own end-product solutions that meet applicable functional safety standards and requirements. Nonetheless, such components are subject to these terms.

No TI components are authorized for use in FDA Class III (or similar life-critical medical equipment) unless authorized officers of the parties have executed a special agreement specifically governing such use.

Only those TI components which TI has specifically designated as military grade or "enhanced plastic" are designed and intended for use in military/aerospace applications or environments. Buyer acknowledges and agrees that any military or aerospace use of TI components which have **not** been so designated is solely at the Buyer's risk, and that Buyer is solely responsible for compliance with all legal and regulatory requirements in connection with such use.

TI has specifically designated certain components as meeting ISO/TS16949 requirements, mainly for automotive use. In any case of use of non-designated products, TI will not be responsible for any failure to meet ISO/TS16949.

### Products

Audio	<a href="http://www.ti.com/audio">www.ti.com/audio</a>
Amplifiers	<a href="http://amplifier.ti.com">amplifier.ti.com</a>
Data Converters	<a href="http://dataconverter.ti.com">dataconverter.ti.com</a>
DLP® Products	<a href="http://www.dlp.com">www.dlp.com</a>
DSP	<a href="http://dsp.ti.com">dsp.ti.com</a>
Clocks and Timers	<a href="http://www.ti.com/clocks">www.ti.com/clocks</a>
Interface	<a href="http://interface.ti.com">interface.ti.com</a>
Logic	<a href="http://logic.ti.com">logic.ti.com</a>
Power Mgmt	<a href="http://power.ti.com">power.ti.com</a>
Microcontrollers	<a href="http://microcontroller.ti.com">microcontroller.ti.com</a>
RFID	<a href="http://www.ti-rfid.com">www.ti-rfid.com</a>
OMAP Applications Processors	<a href="http://www.ti.com/omap">www.ti.com/omap</a>
Wireless Connectivity	<a href="http://www.ti.com/wirelessconnectivity">www.ti.com/wirelessconnectivity</a>

### Applications

Automotive and Transportation	<a href="http://www.ti.com/automotive">www.ti.com/automotive</a>
Communications and Telecom	<a href="http://www.ti.com/communications">www.ti.com/communications</a>
Computers and Peripherals	<a href="http://www.ti.com/computers">www.ti.com/computers</a>
Consumer Electronics	<a href="http://www.ti.com/consumer-apps">www.ti.com/consumer-apps</a>
Energy and Lighting	<a href="http://www.ti.com/energy">www.ti.com/energy</a>
Industrial	<a href="http://www.ti.com/industrial">www.ti.com/industrial</a>
Medical	<a href="http://www.ti.com/medical">www.ti.com/medical</a>
Security	<a href="http://www.ti.com/security">www.ti.com/security</a>
Space, Avionics and Defense	<a href="http://www.ti.com/space-avionics-defense">www.ti.com/space-avionics-defense</a>
Video and Imaging	<a href="http://www.ti.com/video">www.ti.com/video</a>

### TI E2E Community

[e2e.ti.com](http://e2e.ti.com)

Компания «Океан Электроники» предлагает заключение долгосрочных отношений при поставках импортных электронных компонентов на взаимовыгодных условиях!

Наши преимущества:

- Поставка оригинальных импортных электронных компонентов напрямую с производств Америки, Европы и Азии, а так же с крупнейших складов мира;
- Широкая линейка поставок активных и пассивных импортных электронных компонентов (более 30 млн. наименований);
- Поставка сложных, дефицитных, либо снятых с производства позиций;
- Оперативные сроки поставки под заказ (от 5 рабочих дней);
- Экспресс доставка в любую точку России;
- Помощь Конструкторского Отдела и консультации квалифицированных инженеров;
- Техническая поддержка проекта, помощь в подборе аналогов, поставка прототипов;
- Поставка электронных компонентов под контролем ВП;
- Система менеджмента качества сертифицирована по Международному стандарту ISO 9001;
- При необходимости вся продукция военного и аэрокосмического назначения проходит испытания и сертификацию в лаборатории (по согласованию с заказчиком);
- Поставка специализированных компонентов военного и аэрокосмического уровня качества (Xilinx, Altera, Analog Devices, Intersil, Interpoint, Microsemi, Actel, Aeroflex, Peregrine, VPT, Syfer, Eurofarad, Texas Instruments, MS Kennedy, Miteq, Cobham, E2V, MA-COM, Hittite, Mini-Circuits, General Dynamics и др.);

Компания «Океан Электроники» является официальным дистрибьютором и эксклюзивным представителем в России одного из крупнейших производителей разъемов военного и аэрокосмического назначения «JONHON», а так же официальным дистрибьютором и эксклюзивным представителем в России производителя высокотехнологичных и надежных решений для передачи СВЧ сигналов «FORSTAR».



## JONHON

«JONHON» (основан в 1970 г.)

Разъемы специального, военного и аэрокосмического назначения:

(Применяются в военной, авиационной, аэрокосмической, морской, железнодорожной, горно- и нефтедобывающей отраслях промышленности)

«FORSTAR» (основан в 1998 г.)

ВЧ соединители, коаксиальные кабели, кабельные сборки и микроволновые компоненты:

(Применяются в телекоммуникациях гражданского и специального назначения, в средствах связи, РЛС, а так же военной, авиационной и аэрокосмической отраслях промышленности).



Телефон: 8 (812) 309-75-97 (многоканальный)

Факс: 8 (812) 320-03-32

Электронная почта: [ocean@oceanchips.ru](mailto:ocean@oceanchips.ru)

Web: <http://oceanchips.ru/>

Адрес: 198099, г. Санкт-Петербург, ул. Калинина, д. 2, корп. 4, лит. А