

Improved Quad CMOS Analog Switches

DESCRIPTION

The DG211B, DG212B analog switches are highly improved versions of the industry-standard DG211, DG212. These devices are fabricated in Vishay Siliconix' proprietary silicon gate CMOS process, resulting in lower on-resistance, lower leakage, higher speed, and lower power consumption.

These quad single-pole single-throw switches are designed for a wide variety of applications in telecommunications, instrumentation, process control, computer peripherals, etc. An improved charge injection compensation design minimizes switching transients. The DG211B and DG212B can handle up to ± 22 V, and have an improved continuous current rating of 30 mA. An epitaxial layer prevents latchup.

All devices feature true bi-directional performance in the on condition, and will block signals to the supply levels in the off condition.

The DG211B is a normally closed switch and the DG212B is a normally open switch. (see Truth Table.)

FEATURES

- ± 22 V supply voltage rating
- TTL and CMOS compatible logic
- Low on-resistance - $R_{DS(on)}$: 50 Ω
- Low leakage - $I_{D(on)}$: 20 pA
- Single supply operation possible
- Extended temperature range
- Fast switching - t_{ON} : 120 ns
- Low charge injection - Q: 1 pC

BENEFITS

- Wide analog signal range
- Simple logic interface
- Higher accuracy
- Minimum transients
- Reduced power consumption
- Superior to DG211, DG212
- Space savings (TSSOP)

APPLICATIONS

- Industrial instrumentation
- Test equipment
- Communications systems
- Disk drives
- Computer peripherals
- Portable instruments
- Sample-and-hold circuits



RoHS*
COMPLIANT

FUNCTIONAL BLOCK DIAGRAM AND PIN CONFIGURATION

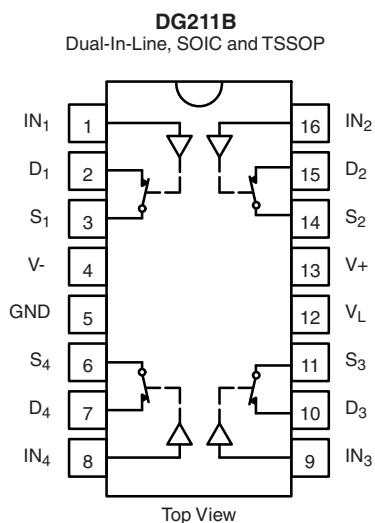

TRUTH TABLE		
Logic	DG211B	DG212B
0	ON	OFF
1	OFF	ON

Logic "0" ≤ 0.8 V
Logic "1" ≥ 2.4 V

* Pb containing terminations are not RoHS compliant, exemptions may apply.

ORDERING INFORMATION			
Temp. Range	Package	Standard Part Number	Lead (Pb)-free Part Number
- 40 °C to 85 °C	16-Pin Plastic DIP	DG211BDJ	DG211BDJ-E3
		DG212BDJ	DG212BDJ-E3
	16-Pin Narrow SOIC	DG211BDY DG211BDY-T1	DG211BDY-E3 DG211BDY-T1-E3
		DG212BDY DG212BDY-T1	DG212BDY-E3 DG212BDY-T1-E3
	16-Pin TSSOP	DG211BDQ DG211BDQ-T1	DG211BDQ-E3 DG211BDQ-T1-E3
		DG212BDQ DG212BDQ-T1	DG212BDQ-E3 DG212BDQ-T1-E3

ABSOLUTE MAXIMUM RATINGS (T _A = 25 °C, unless otherwise noted)			
Parameter		Limit	Unit
Voltages Referenced, V ₊ to V ₋		44	V
GND		25	
Digital Inputs ^a , V _S , V _D		(V ₋ - 2 to (V ₊) + 2 or 30 mA, whichever occurs first	
Current (Any terminal)		30	mA
Peak Current, S or D (Pulsed at 1 ms, 10 % duty cycle max.)		100	
Storage Temperature		- 65 to 125	°C
Power Dissipation (Package) ^b	16-Pin Plastic DIP ^c	470	mW
	16-Pin Narrow SOIC and TSSOP ^d	640	

Notes:

- a. Signals on S_x, D_x, or IN_x exceeding V₊ or V₋ will be clamped by internal diodes. Limit forward diode current to maximum current ratings.
- b. All leads welded or soldered to PC board.
- c. Derate 6.5 mW/°C above 75 °C.
- d. Derate 7.6 mW/°C above 75 °C.

SCHEMATIC DIAGRAM (Typical Channel)

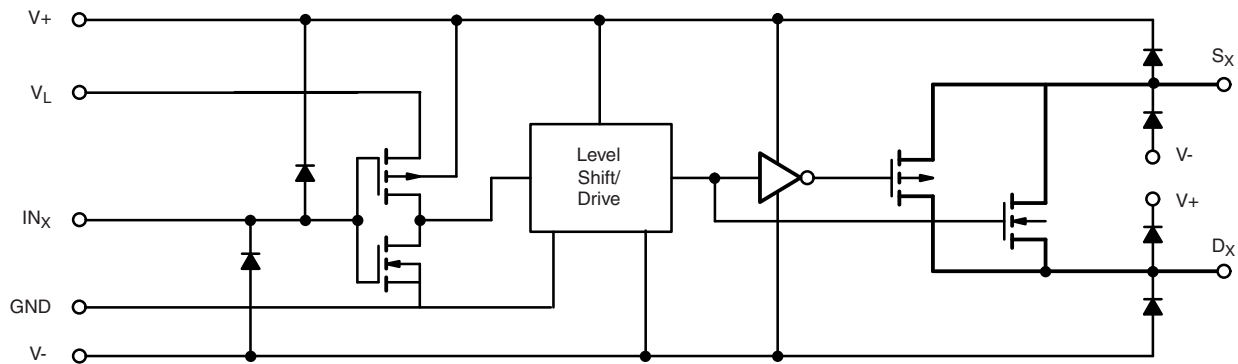

Figure 1.



SPECIFICATIONS							
Parameter	Symbol	Test Conditions Unless Otherwise Specified $V_+ = 15\text{ V}$, $V_- = -15\text{ V}$ $V_L = 5\text{ V}$, $V_{IN} = 2.4\text{ V}$, 0.8 V^e	Temp. ^a	D Suffix - 40 °C to 85 °C			Unit
				Min. ^b	Typ. ^c	Max. ^b	
Analog Switch							
Analog Signal Range ^d	V_{ANALOG}		Full	- 15		15	V
Drain-Source On-Resistance	$R_{DS(on)}$	$V_D = \pm 10\text{ V}$, $I_S = 1\text{ mA}$	Room		45	85	Ω
$R_{DS(on)}$ Match	$\Delta R_{DS(on)}$		Full		2	100	
Source Off Leakage Current	$I_{S(off)}$	$V_S = \pm 14\text{ V}$, $V_D = \pm 14\text{ V}$	Room	- 0.5	± 0.01	0.5	nA
Drain Off Leakage Current	$I_{D(off)}$	$V_D = \pm 14\text{ V}$, $V_S = \pm 14\text{ V}$	Full	- 5		5	
Drain On Leakage Current	$I_{D(on)}$	$V_S = V_D = \pm 14\text{ V}$	Room	- 0.5	± 0.01	0.5	
			Full	- 10	± 0.02	10	
Digital Control							
Input Voltage High	V_{INH}		Full	2.4			V
Input Voltage Low	V_{INL}		Full			0.8	
Input Current	I_{INH} or I_{INL}	V_{INH} or V_{INL}	Full	- 1		1	μA
Input Capacitance	C_{IN}		Room		5		pF
Dynamic Characteristics							
Turn-On Time	t_{ON}	$V_S = 10\text{ V}$ see figure 2	Room			300	ns
Turn-Off Time	t_{OFF}		Room			200	
Charge Injection	Q	$C_L = 1000\text{ pF}$, $V_{gen} = 0\text{ V}$, $R_{gen} = 0\ \Omega$	Room		1		pC
Source-Off Capacitance	$C_{S(off)}$	$V_S = 0\text{ V}$, $f = 1\text{ MHz}$	Room		5		pF
Drain-Off Capacitance	$C_{D(off)}$		Room		5		
Channel-On Capacitance	$C_{D(on)}$	$V_D = V_S = 0\text{ V}$, $f = 1\text{ MHz}$	Room		16		dB
Off Isolation	OIRR	$C_L = 15\text{ pF}$, $R_L = 50\ \Omega$, $V_S = 1\text{ V}_{RMS}$, $f = 100\text{ kHz}$	Room		90		
Channel-to-Channel Crosstalk	X_{TALK}		Room		95		
Power Supply							
Positive Supply Current	I_+	$V_{IN} = 0$ or 5 V	Room			10	μA
Negative Supply Current	I_-		Full	- 10		50	
Logic Supply Current	I_L		Full	- 50			
Power Supply Range for Continuous Operation	V_{OP}		Room			10	V
			Full	± 4.5		50	
			Full			± 22	



SPECIFICATIONS (for Single Supply)							
Parameter	Symbol	Test Conditions Unless Otherwise Specified $V_+ = 12\text{ V}$, $V_- = 0\text{ V}$ $V_L = 5\text{ V}$, $V_{IN} = 2.4\text{ V}$, 0.8 V^e	Temp. ^a	D Suffix -40 °C to 85 °C			Unit
				Min. ^b	Typ. ^c	Max. ^b	
Analog Switch							
Analog Signal Range ^d	V_{ANALOG}		Full	0		12	V
Drain-Source On-Resistance	$R_{DS(on)}$	$V_D = 3\text{ V}$, 8 V , $I_S = 1\text{ mA}$	Room Full		90	160 200	Ω
Dynamic Characteristics							
Turn-On Time	t_{ON}	$V_S = 8\text{ V}$ see figure 1	Room			300	ns
Turn-Off Time	t_{OFF}		Room			200	
Charge Injection	Q	$C_L = 1\text{ nF}$, $V_{gen} = 6\text{ V}$, $R_{gen} = 0\ \Omega$	Room		4		pC
Power Supply							
Positive Supply Current	I_+	$V_{IN} = 0\text{ or }5\text{ V}$	Room Full			10 50	μA
Negative Supply Current	I_-		Room Full	-10 -50			
Logic Supply Current	I_L		Room Full			10 50	
Power Supply Range for Continuous Operation	V_{OP}		Full	+4.5		+25	V

Notes:

- a. Room = 25 °C, Full = as determined by the operating temperature suffix.
- b. The algebraic convention whereby the most negative value is a minimum and the most positive a maximum, is used in this data sheet.
- c. Typical values are for DESIGN AID ONLY, not guaranteed nor subject to production testing.
- d. Guaranteed by design, not subject to production test.
- e. V_{IN} = input voltage to perform proper function.

Stresses beyond those listed under "Absolute Maximum Ratings" may cause permanent damage to the device. These are stress ratings only, and functional operation of the device at these or any other conditions beyond those indicated in the operational sections of the specifications is not implied. Exposure to absolute maximum rating conditions for extended periods may affect device reliability.

TYPICAL CHARACTERISTICS (T_A = 25 °C, unless otherwise noted)

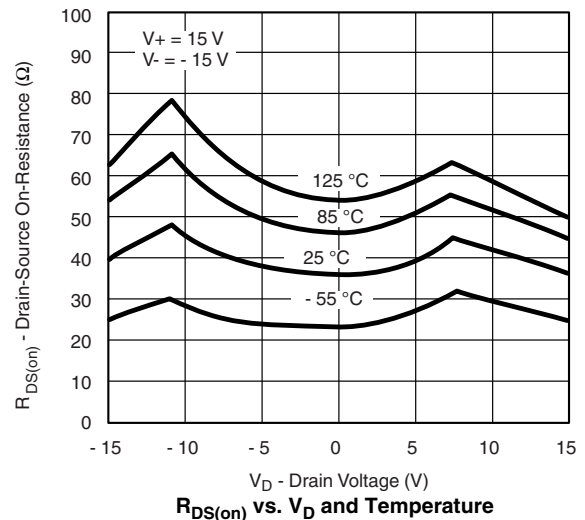
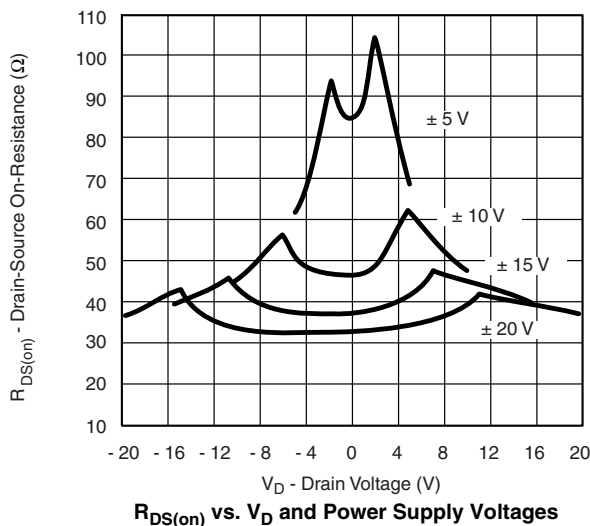

TYPICAL CHARACTERISTICS (T_A = 25 °C, unless otherwise noted)



$R_{DS(on)}$ vs. V_D and Single Power Supply Voltages

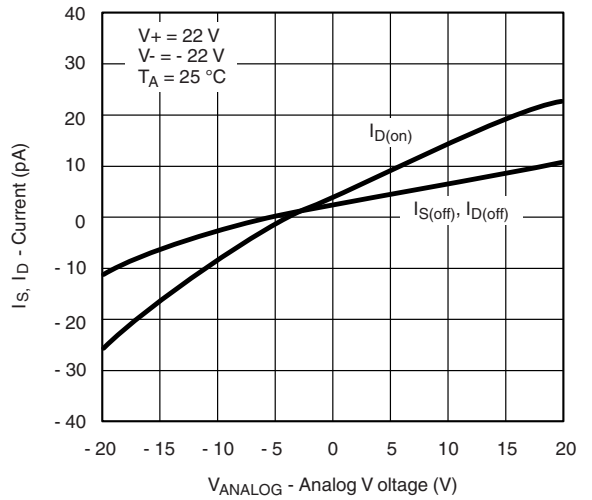

Leakage Currents vs. Analog Voltage



Leakage Current vs. Temperature

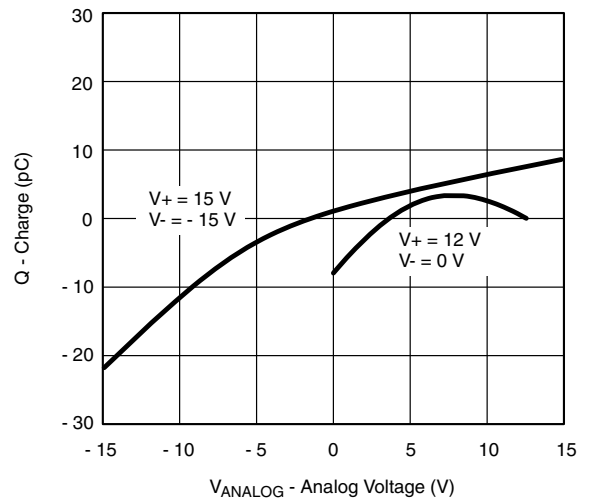

Q_S, Q_D - Charge Injection vs. Analog Voltage

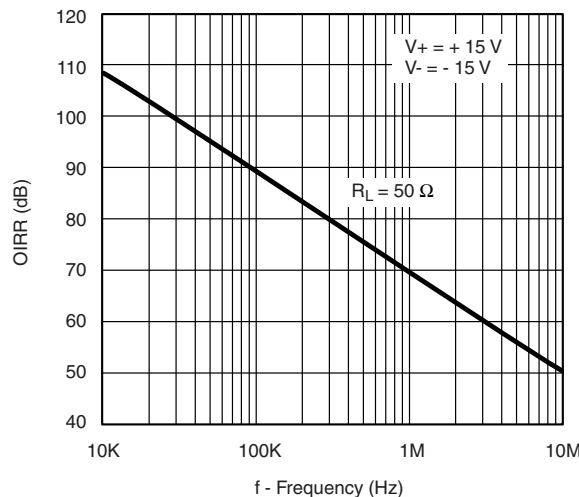

Off Isolation vs. Frequency

TEST CIRCUITS



Figure 2. Switching Time

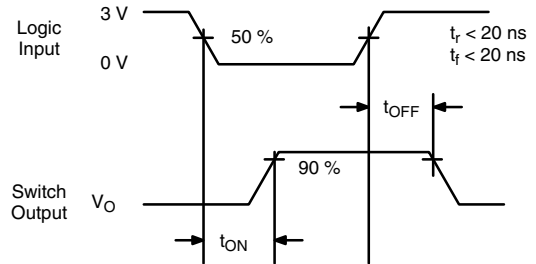

Figure 3. Off Isolation

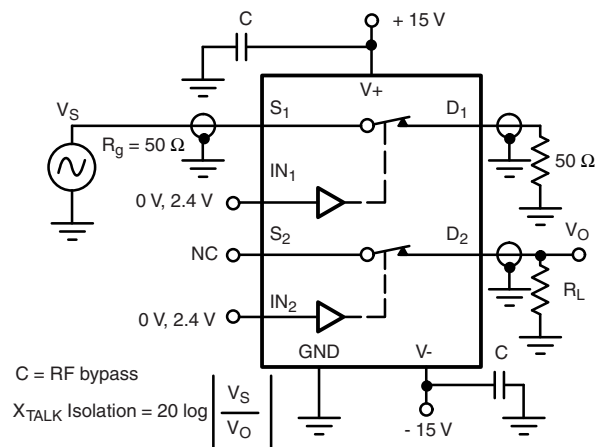

Figure 4. Channel-to-Channel Crosstalk

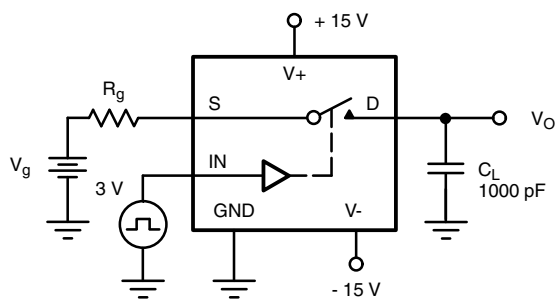
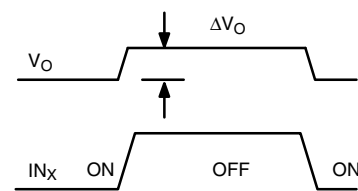

Figure 5. Charge Injection



ΔV_O = measured voltage error due to charge injection
The charge injection in coulombs is $Q = C_L \times \Delta V_O$

APPLICATIONS

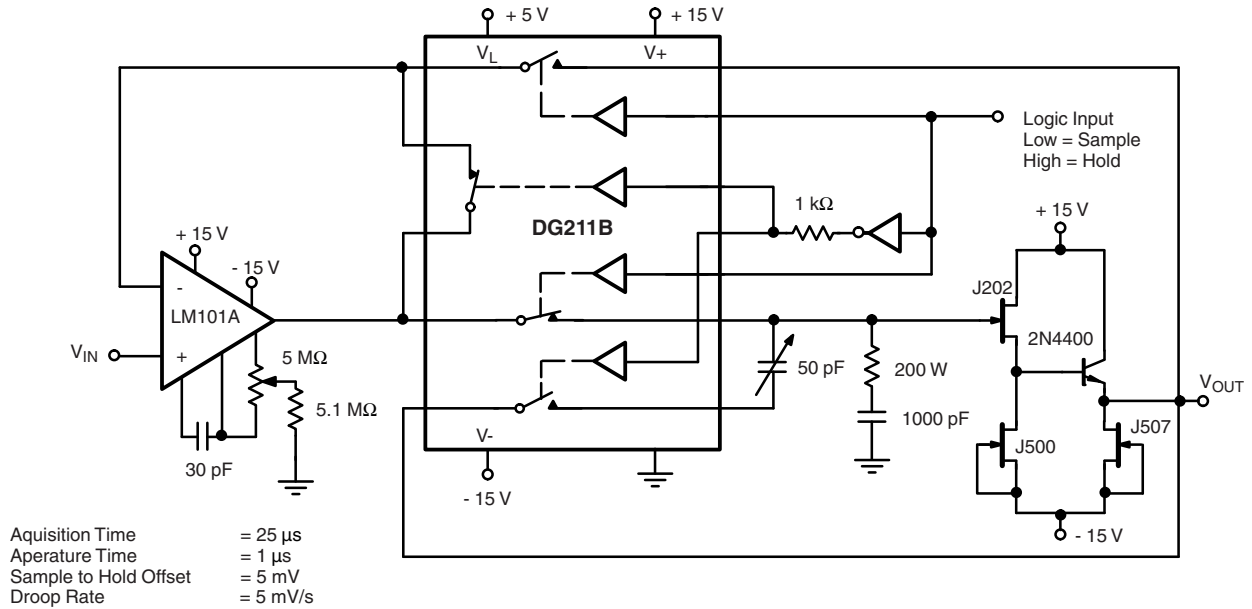

Figure 6. Sample-and-Hold

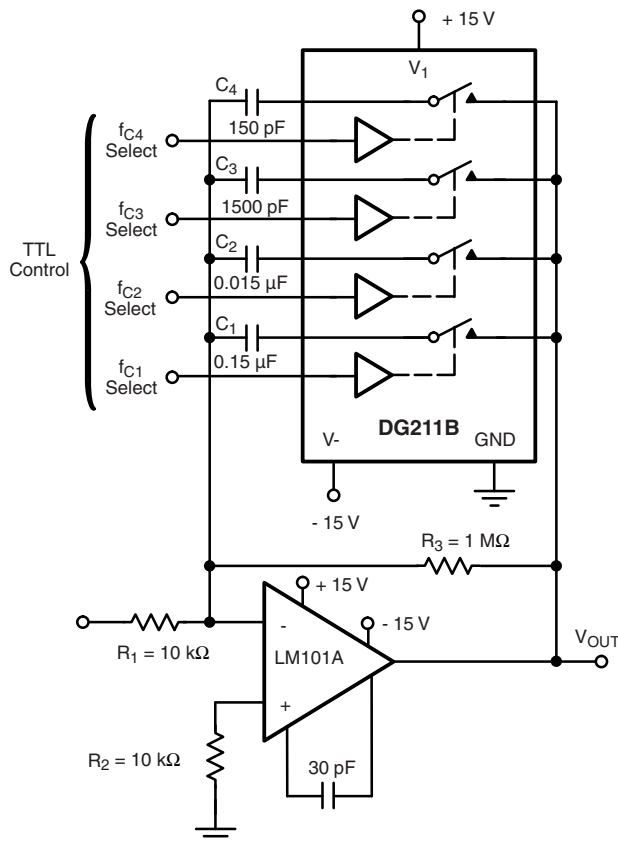
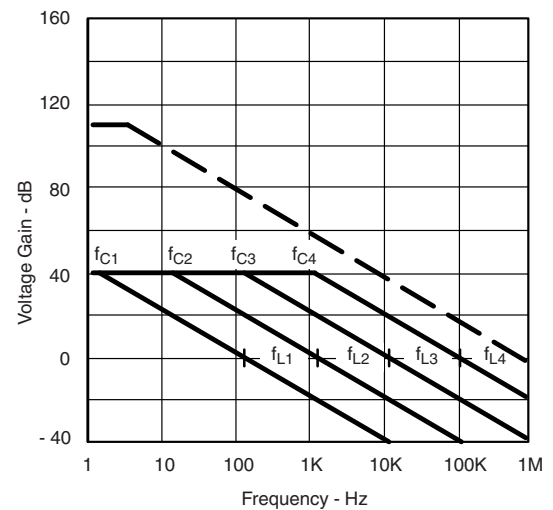

Figure 7. Active Low Pass Filter with Digitally Selected Break Frequency



$$A_L \text{ (Voltage Gain Below Break Frequency)} = \frac{R_3}{R_1} = 100 \text{ (40 dB)}$$

$$f_C \text{ (Break Frequency)} = \frac{1}{2\pi R_3 C_X}$$

$$f_L \text{ (Unity Gain Frequency)} = \frac{1}{2\pi R_1 C_X}$$

$$\text{Max. Attenuation} = \frac{R_{DS(on)}}{10 \text{ k}\Omega} \approx -47 \text{ dB}$$

APPLICATIONS



Figure 8. A Precision Amplifier with Digitally Programmable Input and Gains

Vishay Siliconix maintains worldwide manufacturing capability. Products may be manufactured at one of several qualified locations. Reliability data for Silicon Technology and Package Reliability represent a composite of all qualified locations. For related documents such as package/tape drawings, part marking, and reliability data, see www.vishay.com/ppg?70040.



SOIC (NARROW): 16-LEAD
JEDEC Part Number: MS-012



Dim	MILLIMETERS		INCHES	
	Min	Max	Min	Max
A	1.35	1.75	0.053	0.069
A ₁	0.10	0.20	0.004	0.008
B	0.38	0.51	0.015	0.020
C	0.18	0.23	0.007	0.009
D	9.80	10.00	0.385	0.393
E	3.80	4.00	0.149	0.157
e	1.27 BSC		0.050 BSC	
H	5.80	6.20	0.228	0.244
L	0.50	0.93	0.020	0.037
∅	0°	8°	0°	8°

ECN: S-03946—Rev. F, 09-Jul-01
DWG: 5300

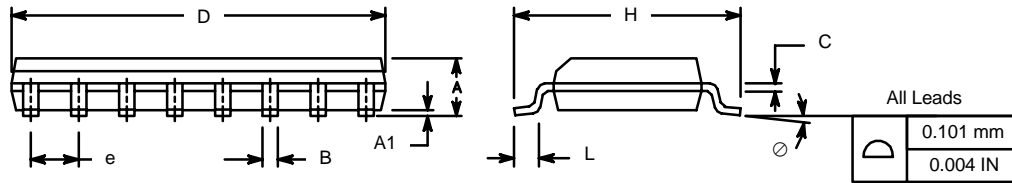

PDIP: 16-LEAD



Dim	MILLIMETERS		INCHES	
	Min	Max	Min	Max
A	3.81	5.08	0.150	0.200
A₁	0.38	1.27	0.015	0.050
B	0.38	0.51	0.015	0.020
B₁	0.89	1.65	0.035	0.065
C	0.20	0.30	0.008	0.012
D	18.93	21.33	0.745	0.840
E	7.62	8.26	0.300	0.325
E₁	5.59	7.11	0.220	0.280
e₁	2.29	2.79	0.090	0.110
e_A	7.37	7.87	0.290	0.310
L	2.79	3.81	0.110	0.150
Q₁	1.27	2.03	0.050	0.080
S	0.38	1.52	.015	0.060

ECN: S-03946—Rev. D, 09-Jul-01
DWG: 5482

TSSOP: 16-LEAD

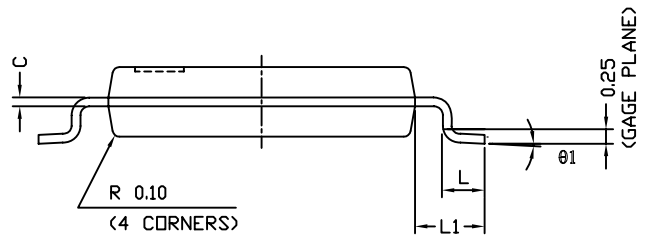
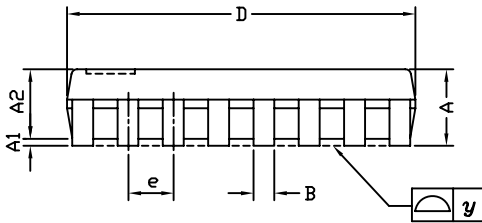

Symbols	DIMENSIONS IN MILLIMETERS		
	Min	Nom	Max
A	-	1.10	1.20
A1	0.05	0.10	0.15
A2	-	1.00	1.05
B	0.22	0.28	0.38
C	-	0.127	-
D	4.90	5.00	5.10
E	6.10	6.40	6.70
E1	4.30	4.40	4.50
e	-	0.65	-
L	0.50	0.60	0.70
L1	0.90	1.00	1.10
y	-	-	0.10
theta 1	0°	3°	6°

ECN: S-61920-Rev. D, 23-Oct-06
DWG: 5624



RECOMMENDED MINIMUM PAD FOR TSSOP-16



Recommended Minimum Pads
Dimensions in inches (mm)

RECOMMENDED MINIMUM PADS FOR SO-16

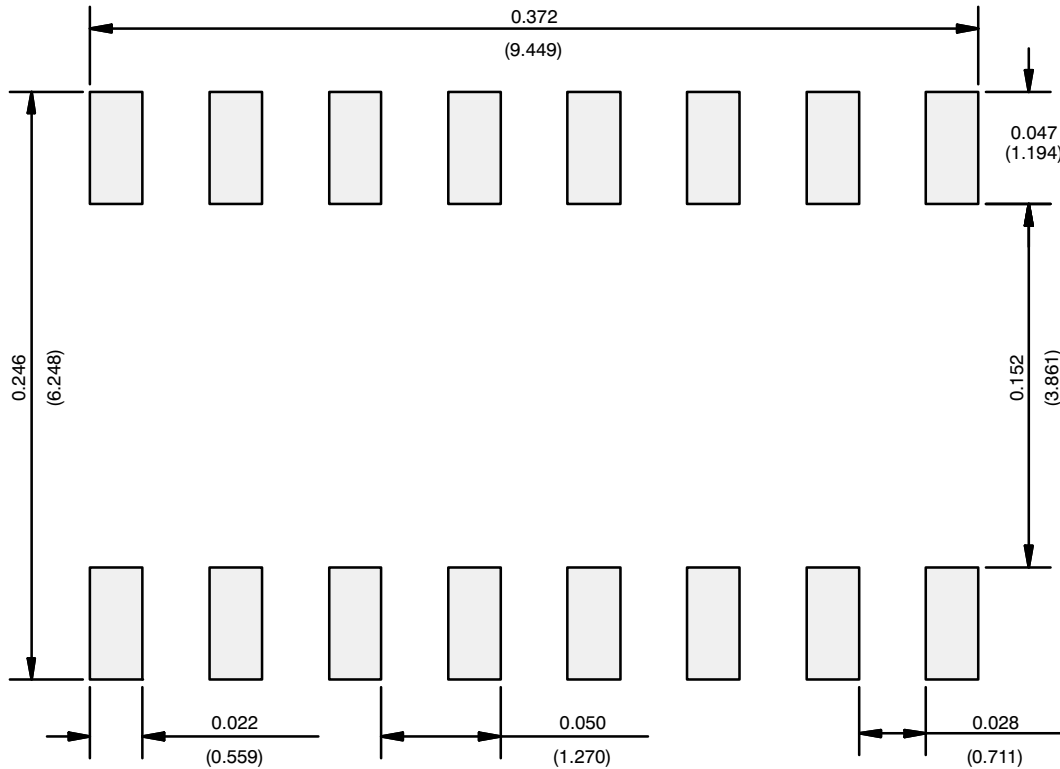

Recommended Minimum Pads
Dimensions in Inches/(mm)

[Return to Index](#)



Disclaimer

ALL PRODUCT, PRODUCT SPECIFICATIONS AND DATA ARE SUBJECT TO CHANGE WITHOUT NOTICE TO IMPROVE RELIABILITY, FUNCTION OR DESIGN OR OTHERWISE.

Vishay Intertechnology, Inc., its affiliates, agents, and employees, and all persons acting on its or their behalf (collectively, "Vishay"), disclaim any and all liability for any errors, inaccuracies or incompleteness contained in any datasheet or in any other disclosure relating to any product.

Vishay makes no warranty, representation or guarantee regarding the suitability of the products for any particular purpose or the continuing production of any product. To the maximum extent permitted by applicable law, Vishay disclaims (i) any and all liability arising out of the application or use of any product, (ii) any and all liability, including without limitation special, consequential or incidental damages, and (iii) any and all implied warranties, including warranties of fitness for particular purpose, non-infringement and merchantability.

Statements regarding the suitability of products for certain types of applications are based on Vishay's knowledge of typical requirements that are often placed on Vishay products in generic applications. Such statements are not binding statements about the suitability of products for a particular application. It is the customer's responsibility to validate that a particular product with the properties described in the product specification is suitable for use in a particular application. Parameters provided in datasheets and/or specifications may vary in different applications and performance may vary over time. All operating parameters, including typical parameters, must be validated for each customer application by the customer's technical experts. Product specifications do not expand or otherwise modify Vishay's terms and conditions of purchase, including but not limited to the warranty expressed therein.

Except as expressly indicated in writing, Vishay products are not designed for use in medical, life-saving, or life-sustaining applications or for any other application in which the failure of the Vishay product could result in personal injury or death. Customers using or selling Vishay products not expressly indicated for use in such applications do so at their own risk. Please contact authorized Vishay personnel to obtain written terms and conditions regarding products designed for such applications.

No license, express or implied, by estoppel or otherwise, to any intellectual property rights is granted by this document or by any conduct of Vishay. Product names and markings noted herein may be trademarks of their respective owners.

Material Category Policy

Vishay Intertechnology, Inc. hereby certifies that all its products that are identified as RoHS-Compliant fulfill the definitions and restrictions defined under Directive 2011/65/EU of The European Parliament and of the Council of June 8, 2011 on the restriction of the use of certain hazardous substances in electrical and electronic equipment (EEE) - recast, unless otherwise specified as non-compliant.

Please note that some Vishay documentation may still make reference to RoHS Directive 2002/95/EC. We confirm that all the products identified as being compliant to Directive 2002/95/EC conform to Directive 2011/65/EU.

Vishay Intertechnology, Inc. hereby certifies that all its products that are identified as Halogen-Free follow Halogen-Free requirements as per JEDEC JS709A standards. Please note that some Vishay documentation may still make reference to the IEC 61249-2-21 definition. We confirm that all the products identified as being compliant to IEC 61249-2-21 conform to JEDEC JS709A standards.

Компания «Океан Электроники» предлагает заключение долгосрочных отношений при поставках импортных электронных компонентов на взаимовыгодных условиях!

Наши преимущества:

- Поставка оригинальных импортных электронных компонентов напрямую с производств Америки, Европы и Азии, а так же с крупнейших складов мира;
- Широкая линейка поставок активных и пассивных импортных электронных компонентов (более 30 млн. наименований);
- Поставка сложных, дефицитных, либо снятых с производства позиций;
- Оперативные сроки поставки под заказ (от 5 рабочих дней);
- Экспресс доставка в любую точку России;
- Помощь Конструкторского Отдела и консультации квалифицированных инженеров;
- Техническая поддержка проекта, помощь в подборе аналогов, поставка прототипов;
- Поставка электронных компонентов под контролем ВП;
- Система менеджмента качества сертифицирована по Международному стандарту ISO 9001;
- При необходимости вся продукция военного и аэрокосмического назначения проходит испытания и сертификацию в лаборатории (по согласованию с заказчиком);
- Поставка специализированных компонентов военного и аэрокосмического уровня качества (Xilinx, Altera, Analog Devices, Intersil, Interpoint, Microsemi, Actel, Aeroflex, Peregrine, VPT, Syfer, Eurofarad, Texas Instruments, MS Kennedy, Miteq, Cobham, E2V, MA-COM, Hittite, Mini-Circuits, General Dynamics и др.);

Компания «Океан Электроники» является официальным дистрибьютором и эксклюзивным представителем в России одного из крупнейших производителей разъемов военного и аэрокосмического назначения «JONHON», а так же официальным дистрибьютором и эксклюзивным представителем в России производителя высокотехнологичных и надежных решений для передачи СВЧ сигналов «FORSTAR».



JONHON

«JONHON» (основан в 1970 г.)

Разъемы специального, военного и аэрокосмического назначения:

(Применяются в военной, авиационной, аэрокосмической, морской, железнодорожной, горно- и нефтедобывающей отраслях промышленности)

«FORSTAR» (основан в 1998 г.)

ВЧ соединители, коаксиальные кабели,
кабельные сборки и микроволновые компоненты:

(Применяются в телекоммуникациях гражданского и специального назначения, в средствах связи, РЛС, а так же военной, авиационной и аэрокосмической отраслях промышленности).



Телефон: 8 (812) 309-75-97 (многоканальный)

Факс: 8 (812) 320-03-32

Электронная почта: ocean@oceanchips.ru

Web: <http://oceanchips.ru/>

Адрес: 198099, г. Санкт-Петербург, ул. Калинина, д. 2, корп. 4, лит. А