

Knobs, Machined Aluminum

KLNS SERIES



KLNS500B1/8



KLNS900B1/4



Tyco Straight Knurl with Indicator Line on Top, Side and Skirt								
Electronics	Alcoswitch	Color	A	B	C	D	E	G
1-1437622-6	KLNS500A1/8	Natural	.500(12.7)	.280(7.11)	.380(9.65)	.750(19.0)	.160(4.07)	.630(16.0)
1-1437622-5	KLNS500A1/4	Natural	.500(12.7)	.280(7.11)	.380(9.65)	.750(19.0)	.160(4.07)	.630(16.0)
1-1437622-8	KLNS500B1/8	Black	.500(12.7)	.280(7.11)	.380(9.65)	.750(19.0)	.160(4.07)	.630(16.0)
1-1437622-7	KLNS500B1/4	Black	.500(12.7)	.280(7.11)	.380(9.65)	.750(19.0)	.160(4.07)	.630(16.0)
2-1437622-0	KLNS700A1/4	Natural	.750(19.0)	.280(7.11)	.590(14.9)	1.13(28.7)	.160(4.07)	.630(16.0)
2-1437622-1	KLNS700B1/4	Black	.750(19.0)	.280(7.11)	.590(14.9)	1.13(28.7)	.160(4.07)	.630(16.0)
2-1437622-2	KLNS900A1/4	Natural	.940(23.9)	.280(7.11)	.710(18.0)	1.40(35.5)	.160(4.07)	.630(16.0)
2-1437622-3	KLNS900B1/4	Black	.940(23.9)	.280(7.11)	.710(18.0)	1.40(35.5)	.160(4.07)	.630(16.0)

KN SERIES



KN501A1/4

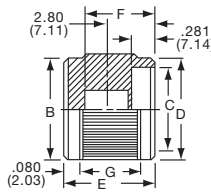

NO. 6-32 SET SCREW 2 PLACES
1/8" SHAFT=.126" (3.20)
1/4" SHAFT=.251" (6.38)

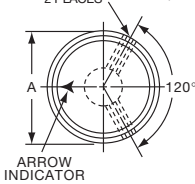

ARROW INDICATOR

Tyco Straight Knurl with Arrowhead Indicator								
Electronics	Alcoswitch	Color	A	B	C	D	E	G
5-1437622-1	KN501A1/8	Natural	.500(12.7)	.445(11.3)	.374(9.50)	.445(11.3)	.625(15.9)	.512(13.0)
5-1437622-0	KN501A1/4	Natural	.500(12.7)	.445(11.3)	.374(9.50)	.445(11.3)	.625(15.9)	.512(13.0)
5-1437622-3	KN501B1/8	Black	.500(12.7)	.445(11.3)	.374(9.50)	.445(11.3)	.625(15.9)	.512(13.0)
5-1437622-2	KN501B1/4	Black	.500(12.7)	.445(11.3)	.374(9.50)	.445(11.3)	.625(15.9)	.512(13.0)
6-1437622-2	KN701A1/4	Natural	.750(19.1)	.695(17.7)	.590(15.0)	.695(17.7)	.625(15.9)	.512(13.0)
6-1437622-3	KN701B1/4	Black	.750(19.1)	.695(17.7)	.590(15.0)	.695(17.7)	.625(15.9)	.512(13.0)
Two Toned			Body-Top					
5-1437622-5	KN501BA1/8	Blk. - Ntl.	.500(12.7)	.445(11.3)	.374(9.50)	.445(11.3)	.625(15.9)	.512(13.0)
5-1437622-4	KN501BA1/4	Blk. - Ntl.	.500(12.7)	.445(11.3)	.374(9.50)	.445(11.3)	.625(15.9)	.512(13.0)
6-1437622-5	KN701BA1/8	Blk. - Ntl.	.750(19.1)	.695(17.7)	.590(15.0)	.695(17.7)	.625(15.9)	.512(13.0)
6-1437622-4	KN701BA1/4	Blk. - Ntl.	.750(19.1)	.695(17.7)	.590(15.0)	.695(17.7)	.625(15.9)	.512(13.0)

KN SERIES



KN1751AS1/4



KN1751B1/4



1/4" SHAFT=.251" (6.38)

Tyco Straight Knurl with & without "Fingertip" Spinner								
Electronics	Alcoswitch	Color	A	B	C	D	E	G
Less Indicator								
3-1437622-2	KN1751A1/4	Natural	1.75(44.5)	1.55(39.4)	1.38(35.1)	1.65(41.9)	.620(15.0)	.508(12.9)
3-1437622-6	KN1751B1/4	Black	1.75(44.5)	1.55(39.4)	1.38(35.1)	1.65(41.9)	.620(15.8)	.508(12.9)
Two Toned								
3-1437622-3	KN1751AB1/4	Ntl. - Blk.	1.75(44.5)	1.55(39.4)	1.38(35.1)	1.65(41.9)	.620(15.8)	.508(12.9)
3-1437622-7	KN1751BA1/4	Blk. - Natural	1.75(44.5)	1.55(39.4)	1.38(35.1)	1.65(41.9)	.620(15.8)	.508(12.9)
With Indicator								
3-1437622-5	KN1750A1/4	Natural	1.75(44.5)	1.55(39.4)	1.38(35.1)	1.65(41.9)	.620(15.8)	.508(12.9)
3-1437622-1	KN1750B1/4	Black	1.75(44.5)	1.55(39.4)	1.38(35.1)	1.65(41.9)	.620(15.8)	.508(12.9)
With Spinner/Less Indicator								
3-1437622-5	KN1751AS1/4	Natural	1.75(44.5)	1.55(39.4)	1.38(35.1)	1.65(41.9)	.620(15.8)	.508(12.9)
3-1437622-8	KN1751BS1/4	Black	1.75(44.5)	1.55(39.4)	1.38(35.1)	1.65(41.9)	.620(15.8)	.508(12.9)

K

K Series

K8

Knobs, Machined Aluminum



KN SERIES



KN5700B1/4

Concentric Set with Straight Knurl with Indicator Lines									
Tyco Electronics	Alcoswitch	Color	A	B	C	D	E	F	G
5-1437622-6	KN5700A1/4	Natural	.750(19.1)	.500(12.7)	.590(15.0)	.700(17.8)	.625(15.9)	1.16(29.5)	.281(7.14)
5-1437622-7	KN5700B1/4	Black	.750(19.1)	.500(12.7)	.590(15.0)	.700(17.8)	.625(15.9)	1.16(29.5)	.281(7.14)

Straight Knurl with & without Indicator Line Diameter Dimensions

Tyco Electronics	Alcoswitch	Color Body-Top	A	B	C	D	E	F	G
4-1437622-3	KN500A1/8	Natural	.500(12.7)	.445(11.3)	.374(9.50)	.445(11.5)	.625(15.9)	.512(13.0)	.456(11.6)
4-1437622-2	KN500A1/4	Natural	.500(12.7)	.445(11.3)	.374(9.50)	.445(11.5)	.625(15.9)	.512(13.0)	.456(11.6)
4-1437622-7	KN500B1/8	Black	.500(12.7)	.445(11.3)	.374(9.50)	.445(11.5)	.625(15.9)	.512(13.0)	.456(11.6)
4-1437622-6	KN500B1/4	Black	.500(12.7)	.445(11.3)	.374(9.50)	.445(11.5)	.625(15.9)	.512(13.0)	.456(11.6)
5-1437622-8	KN700A1/4	Natural	.750(19.1)	.695(17.7)	.590(15.0)	.695(17.7)	.625(15.9)	.512(13.0)	.456(11.6)
6-1437622-0	KN700B1/4	Black	.750(19.1)	.695(17.7)	.590(15.0)	.695(17.7)	.625(15.9)	.512(13.0)	.456(11.6)
6-1437622-6	KN900A1/4	Natural	.949(24.1)	.894(22.7)	.696(17.7)	.894(22.7)	.625(15.9)	.512(13.0)	.456(11.6)
6-1437622-8	KN900B1/4	Black	.949(24.1)	.894(22.7)	.696(17.7)	.894(22.7)	.625(15.9)	.512(13.0)	.456(11.7)
2-1437622-5	KN1250A1/4	Natural	1.25(31.8)	1.20(30.5)	.984(25.0)	1.20(30.5)	.625(15.9)	.512(13.0)	.456(11.6)
2-1437622-7	KN1250B1/4	Black	1.25(31.8)	1.20(30.5)	.984(25.0)	1.20(30.5)	.625(15.9)	.512(13.0)	.456(11.6)
Two-Toned									
4-1437622-5	KN500AB1/8	Ntl - Blk.	.500(12.7)	.445(11.3)	.374(9.50)	.445(11.5)	.625(15.9)	.512(13.0)	.456(11.6)
4-1437622-4	KN500AB1/4	Ntl - Blk.	.500(12.7)	.445(11.3)	.374(9.50)	.445(11.5)	.625(15.9)	.512(13.0)	.456(11.6)
4-1437622-9	KN500BA1/8	Blk - Ntl.	.500(12.7)	.445(11.3)	.374(9.50)	.445(11.5)	.625(15.9)	.512(13.0)	.456(11.6)
4-1437622-8	KN500BA1/4	Blk - Ntl.	.500(12.7)	.445(11.3)	.374(9.50)	.445(11.5)	.625(15.9)	.512(13.0)	.456(11.6)
5-1437622-9	KN700AB1/4	Ntl - Blk.	.750(19.1)	.695(17.7)	.445(11.5)	.695(17.7)	.625(15.9)	.512(13.0)	.456(11.6)
6-1437622-1	KN700BA1/4	Blk - Ntl.	.750(19.1)	.695(17.7)	.445(11.5)	.695(17.7)	.625(15.9)	.512(13.0)	.456(11.6)
6-1437622-7	KN900AB1/4	Ntl - Blk.	.949(24.1)	.894(22.7)	.695(17.7)	.894(22.7)	.625(15.9)	.512(13.0)	.456(11.6)
6-1437622-9	KN900BA1/4	Blk - Ntl.	.949(24.1)	.894(22.7)	.695(17.7)	.894(22.7)	.625(15.9)	.512(13.0)	.456(11.7)
2-1437622-6	KN1250AB1/4	Ntl - Blk.	1.25(31.8)	1.20(30.5)	.984(25.0)	1.20(30.5)	.625(15.9)	.512(13.0)	.456(11.6)
2-1437622-8	KN1250BA1/4	Blk - Ntl.	1.25(31.8)	1.20(30.5)	.984(25.0)	1.20(30.5)	.625(15.9)	.512(13.0)	.456(11.6)
Less Indicator									
2-1437622-9	KN1251A1/4	Natural	1.25(31.8)	1.20(30.5)	.984(25.0)	1.25(31.7)	.625(15.9)	.512(13.0)	.456(11.7)
3-1437622-0	KN1251B1/4	Black	1.25(31.8)	1.20(30.5)	.984(25.0)	1.25(31.7)	.625(15.9)	.512(13.0)	.456(11.7)

KN SERIES



KN500A1/4



KN900BA1/4

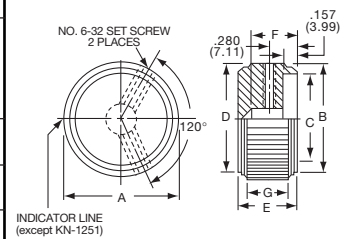

KN SERIES



KN1755BS1/4

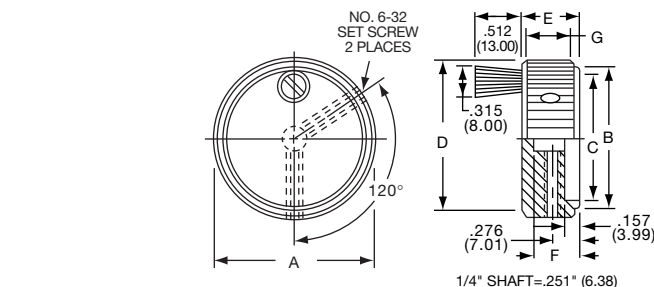

Straight Knurl with "Crank" Spinner									
Tyco Electronics	Alcoswitch	Color Body-Top/Spin	A	B	C	D	E	F	G
4-1437622-1	KN1755AS1/4	Natural	1.76(44.7)	1.56(39.5)	.138(35.0)	1.65(41.8)	.630(16.0)	.512(13.0)	.492(12.5)
4-1437622-1	KN1755BS1/4	Black	1.76(44.7)	1.56(39.5)	.138(35.0)	1.65(41.8)	.630(16.0)	.512(13.0)	.492(12.5)
3-1437622-9	KN1755ABS1/4	Ntl.-Blk./Blk.	1.76(44.7)	1.56(39.5)	1.38(35.0)	1.65(41.8)	.630(16.0)	.512(13.0)	.492(12.5)
4-1437622-0	KN1755BAS1/4	Blk.-Ntl. Blk.	1.76(44.7)	1.56(39.5)	1.38(35.0)	1.65(41.8)	.630(16.0)	.512(13.0)	.492(12.5)

Knobs, Machined Aluminum

KNS SERIES



KNS501A1/4



KNS701B1/4

KNS701BA1/4

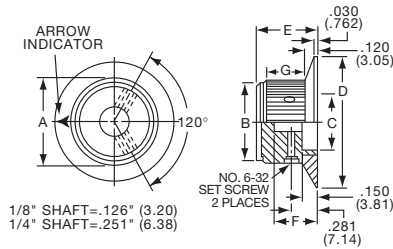

Tyco		Straight Knurl with Arrowhead Indicator on Skirt							
Electronics	Alcoswitch	Color	A	B	C	D	E	F	G
7-1437622-3	KNS501A1/8	Natural	.500(12.7)	.445(11.3)	.370(9.40)	.750(19.1)	.625(15.9)	.512(13.0)	.428(10.9)
7-1437622-2	KNS501A1/4	Natural	.500(12.7)	.445(11.3)	.370(9.40)	.750(19.1)	.625(15.9)	.512(13.0)	.428(10.9)
7-1437622-5	KNS501B1/8	Black	.500(12.7)	.445(11.3)	.370(9.40)	.750(19.1)	.625(15.9)	.512(13.0)	.428(10.9)
7-1437622-4	KNS501B1/4	Black	.500(12.7)	.445(11.3)	.370(9.40)	.750(19.1)	.625(15.9)	.512(13.0)	.428(10.9)
7-1437622-8	KNS701A1/4	Natural	.750(19.1)	.695(17.7)	.590(15.0)	1.12(28.5)	.625(15.9)	.512(13.0)	.428(10.9)
7-1437622-9	KNS701B1/4	Black	.750(19.1)	.695(17.7)	.590(15.0)	1.12(28.5)	.625(15.9)	.512(13.0)	.428(10.9)
Two-Toned Body-Top/Skirt									
7-1437622-7	KNS501BA1/8	Blk.- Ntl.	.500(12.7)	.695(17.7)	.370(9.40)	.750(19.1)	.625(15.9)	.512(13.0)	.428(10.9)
7-1437622-6	KNS501BA1/4	Blk.- Ntl.	.500(12.7)	.695(17.7)	.370(9.40)	.750(19.1)	.625(15.9)	.512(13.0)	.428(10.9)
8-1437622-1	KNS701BA1/8	Blk.- Ntl.	.750(19.1)	.695(17.7)	.590(15.0)	1.12(28.5)	.625(15.9)	.512(13.0)	.428(10.9)
8-1437622-0	KNS701BA1/4	Blk.- Ntl.	.750(19.1)	.695(17.7)	.590(15.0)	1.12(28.5)	.625(15.9)	.512(13.0)	.428(10.9)

KPN SERIES



KPN500B1/8



Tyco		Straight Knurl with Pointer and Indicator Line							
Electronics	Alcoswitch	Color	A	B	C	D	E	F	G
9-1437622-1	KPN500A1/8	Natural	.500(12.7)	.445(11.3)	.372(9.45)	.445(11.3)	.368(9.35)	.195(4.95)	.354(8.99)
9-1437622-0	KPN500A1/4	Natural	.500(12.7)	.445(11.3)	.372(9.45)	.445(11.3)	.368(9.35)	.195(4.95)	.354(8.99)
9-1437622-3	KPN500B1/8	Black	.500(12.7)	.445(11.3)	.372(9.45)	.445(11.3)	.368(9.35)	.195(4.95)	.354(8.99)
9-1437622-2	KPN500B1/4	Black	.500(12.7)	.445(11.3)	.372(9.45)	.445(11.3)	.368(9.35)	.195(4.95)	.354(8.99)
9-1437622-5	KPN700A1/4	Natural	.750(19.1)	.695(17.65)	.590(15.0)	.695(17.7)	.515(13.1)	.234(5.94)	.394(10.0)
9-1437622-6	KPN700B1/4	Black	.750(19.1)	.695(17.65)	.590(15.0)	.695(17.7)	.515(13.1)	.234(5.94)	.394(10.0)
9-1437622-7	KPN900A1/4	Natural	.937(23.8)	.882(22.40)	.692(17.6)	.882(22.4)	.630(16.0)	.276(7.01)	.350(8.90)
9-1437622-9	KPN900B1/4	Black	.937(23.8)	.882(22.40)	.692(17.6)	.882(22.4)	.630(16.0)	.276(7.01)	.350(8.90)

KS SERIES



KS500A1/4

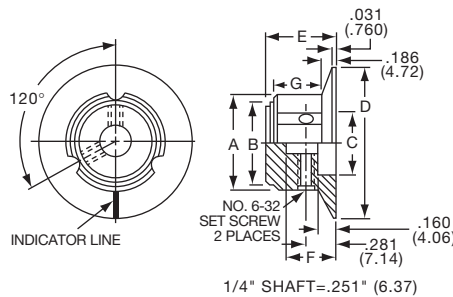

Tyco		3 Flute Design with Aluminum Skirt and Indicator Line							
Electronics	Alcoswitch	Color	A	B	C	D	E	F	G
1437623-3	KS500A1/8	Natural	.500(12.7)	.430(10.9)	.360(9.14)	.750(19.1)	.620(15.8)	.510(13.0)	.430(10.9)
1437623-2	KS500A1/4	Natural	.500(12.7)	.430(10.9)	.360(9.14)	.750(19.1)	.620(15.8)	.510(13.0)	.430(10.9)
1437623-5	KS500B1/8	Black	.500(12.7)	.430(10.9)	.360(9.14)	.750(19.1)	.620(15.8)	.510(13.0)	.430(10.9)
1437623-4	KS500B1/4	Black	.500(12.7)	.430(10.9)	.360(9.14)	.750(19.1)	.620(15.8)	.510(13.0)	.430(10.9)
1437623-6	KS700A1/4	Natural	.750(19.0)	.650(16.5)	.590(14.9)	1.12(28.4)	.620(15.8)	.510(13.0)	.430(10.9)
1437623-7	KS700B1/4	Black	.750(19.0)	.650(16.5)	.590(14.9)	1.12(28.4)	.620(15.8)	.510(13.0)	.430(10.9)
1437623-8	KS900A1/4	Natural	.940(23.9)	.820(20.8)	.710(18.0)	1.40(35.6)	.620(15.8)	.510(13.0)	.430(10.9)
1437623-9	KS900B1/4	Black	.940(23.9)	.820(20.8)	.710(18.0)	1.40(35.6)	.620(15.8)	.510(13.0)	.430(10.9)



KS900B1/4

K Series

K10

Knobs, Machined Aluminum



KT SERIES



KT500A1/4



KT700A1/4

Tyco		Square Serration with Indicator Line							
Electronics	Alcoswitch	Color	A	B	C	D	E	F	G
1-1437623-2	KT500A1/4	Natural	.500(12.7)	.430(10.9)	.375(9.53)	.430(10.9)	.280(7.11)	.510(13.0)	.630(16.0)
1-1437623-4	KT500B1/8	Black	.500(12.7)	.430(10.9)	.375(9.53)	.430(10.9)	.280(7.11)	.510(13.0)	.630(16.0)
1-1437623-3	KT500B1/4	Black	.500(12.7)	.430(10.9)	.375(9.53)	.430(10.9)	.280(7.11)	.510(13.0)	.630(16.0)
1-1437623-6	KT700A1/4	Natural	.740(18.8)	.650(16.5)	.590(15.0)	.650(16.5)	.280(7.11)	.510(13.0)	.630(16.0)
1-1437623-7	KT700B1/4	Black	.740(18.8)	.650(16.5)	.590(15.0)	.650(16.5)	.280(7.11)	.510(13.0)	.630(16.0)
1-1437623-8	KT900A1/4	Natural	.940(23.9)	.816(20.7)	.710(18.0)	.816(20.7)	.280(7.11)	.510(13.0)	.630(16.0)
1-1437623-9	KT900B1/4	Black	.940(23.9)	.816(20.7)	.710(18.0)	.816(20.7)	.280(7.11)	.510(13.0)	.630(16.0)

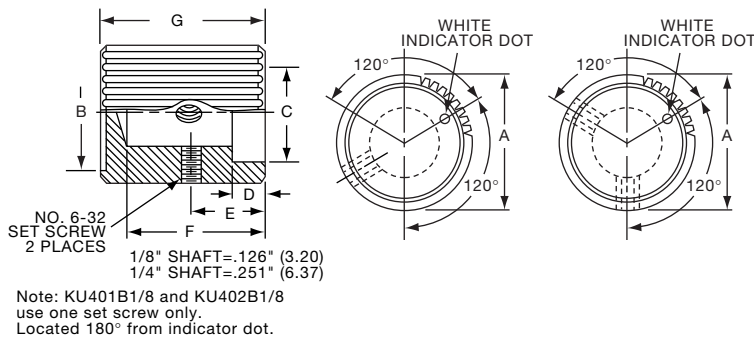

KU SERIES



KU402B1/8

Tyco		Serrated Diamond Trim Cut with Dot Indicator							
Electronics	Alcoswitch	Color	A	B	C	D	E	F	G
2-1437623-1	KU401B1/8	Black	.374(9.50)	.283(7.19)	.276(7.01)	.098(2.49)	.177(4.50)	.236(5.99)	.299(7.60)
2-1437623-2	KU402B1/8	Black	.374(9.50)	.283(7.19)	.276(7.01)	.098(2.49)	.197(5.00)	.354(8.99)	.449(11.40)
2-1437623-3	KU500B1/8	Black	.500(12.7)	.409(10.4)	.374(9.50)	.118(3.00)	.276(7.01)	.512(13.0)	.598(15.2)
	KU500B1/4	Black	.500(12.7)	.409(10.4)	.374(9.50)	.118(3.00)	.276(7.01)	.512(13.0)	.598(15.2)
2-1437623-4	KU700B1/4	Black	.740(18.8)	.650(16.5)	.591(15.0)	.118(3.00)	.276(7.01)	.512(13.0)	.598(15.2)

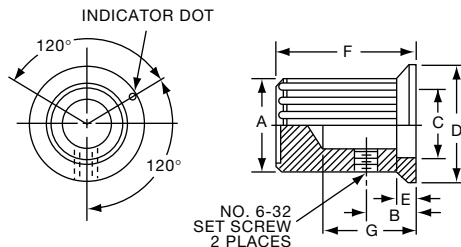

KUS SERIES



KUS402B1/8



KUS700B1/4

Tyco		Serrated Diamond Trim Cut with Dot Indicator							
Electronics	Alcoswitch	Color	A	B	C	D	E	F	G
2-1437623-9	KUS402B1/8	Black	.374(9.50)	.197(5.00)	.276(7.01)	.520(13.2)	.098(2.49)	.450(11.4)	.354(8.99)
3-1437623-0	KUS500B1/8	Black	.500(12.7)	.276(7.01)	.374(9.50)	.700(17.8)	.118(3.00)	.600(15.2)	.512(13.0)
	KUS500B1/4	Black	.500(12.7)	.276(7.01)	.374(9.50)	.700(17.8)	.118(3.00)	.600(15.2)	.512(13.0)
3-1437623-1	KUS700B1/4	Black	.740(18.8)	.276(7.01)	.591(15.0)	1.03(26.2)	.118(3.00)	.600(15.2)	.512(13.0)

Note: KUS402B1/8 has #4.40 setscrew

Компания «Океан Электроники» предлагает заключение долгосрочных отношений при поставках импортных электронных компонентов на взаимовыгодных условиях!

Наши преимущества:

- Поставка оригинальных импортных электронных компонентов напрямую с производств Америки, Европы и Азии, а так же с крупнейших складов мира;
- Широкая линейка поставок активных и пассивных импортных электронных компонентов (более 30 млн. наименований);
- Поставка сложных, дефицитных, либо снятых с производства позиций;
- Оперативные сроки поставки под заказ (от 5 рабочих дней);
- Экспресс доставка в любую точку России;
- Помощь Конструкторского Отдела и консультации квалифицированных инженеров;
- Техническая поддержка проекта, помощь в подборе аналогов, поставка прототипов;
- Поставка электронных компонентов под контролем ВП;
- Система менеджмента качества сертифицирована по Международному стандарту ISO 9001;
- При необходимости вся продукция военного и аэрокосмического назначения проходит испытания и сертификацию в лаборатории (по согласованию с заказчиком);
- Поставка специализированных компонентов военного и аэрокосмического уровня качества (Xilinx, Altera, Analog Devices, Intersil, Interpoint, Microsemi, Actel, Aeroflex, Peregrine, VPT, Syfer, Eurofarad, Texas Instruments, MS Kennedy, Miteq, Cobham, E2V, MA-COM, Hittite, Mini-Circuits, General Dynamics и др.);

Компания «Океан Электроники» является официальным дистрибьютором и эксклюзивным представителем в России одного из крупнейших производителей разъемов военного и аэрокосмического назначения «JONHON», а так же официальным дистрибьютором и эксклюзивным представителем в России производителя высокотехнологичных и надежных решений для передачи СВЧ сигналов «FORSTAR».



JONHON

«JONHON» (основан в 1970 г.)

Разъемы специального, военного и аэрокосмического назначения:

(Применяются в военной, авиационной, аэрокосмической, морской, железнодорожной, горно- и нефтедобывающей отраслях промышленности)

«FORSTAR» (основан в 1998 г.)

ВЧ соединители, коаксиальные кабели,
кабельные сборки и микроволновые компоненты:

(Применяются в телекоммуникациях гражданского и специального назначения, в средствах связи, РЛС, а так же военной, авиационной и аэрокосмической отраслях промышленности).



Телефон: 8 (812) 309-75-97 (многоканальный)

Факс: 8 (812) 320-03-32

Электронная почта: ocean@oceanchips.ru

Web: <http://oceanchips.ru/>

Адрес: 198099, г. Санкт-Петербург, ул. Калинина, д. 2, корп. 4, лит. А