

A new series of easy-to-use models for standard- and double-distance

- Stainless steel and brass housing
- Two housing length for each type
- Pre-wired and Plug-in connector types
- Short-circuit protection and reverse polarity protection



### Ordering Information

#### ■ Cable types

##### Brass housing

| Diameter | Length | Mounting     | Sensing Distance | Output           |                  |                  |                  |
|----------|--------|--------------|------------------|------------------|------------------|------------------|------------------|
|          |        |              |                  | NPN / NO         | NPN / NC         | PNP / NO         | PNP / NC         |
| Ø6,5     | 30 mm  | Shielded     | 1,5 mm           | E2EL-C1R5E1 2M   | E2EL-C1R5E2 2M   | E2EL-C1R5F1 2M   | E2EL-C1R5F2 2M   |
|          | 32 mm  | Non-shielded | 2,0 mm           | E2EL-C2ME1 2M    | E2EL-C2ME2 2M    | E2EL-C2MF1 2M    | E2EL-C2MF2 2M    |
|          | 45 mm  | Shielded     | 1,5 mm           | E2EL-C1R5E1-L 2M | E2EL-C1R5E2-L 2M | E2EL-C1R5F1-L 2M | E2EL-C1R5F2-L 2M |
|          | 47 mm  | Non-shielded | 2,0 mm           | E2EL-C2ME1-L 2M  | E2EL-C2ME2-L 2M  | E2EL-C2MF1-L 2M  | E2EL-C2MF2-L 2M  |
| M8       | 30 mm  | Shielded     | 1,5 mm           | E2EL-X1R5E1 2M   | E2EL-X1R5E2 2M   | E2EL-X1R5F1 2M   | E2EL-X1R5F2 2M   |
|          | 32 mm  | Non-shielded | 2,0 mm           | E2EL-X2ME1 2M    | E2EL-X2ME2 2M    | E2EL-X2MF1 2M    | E2EL-X2MF2 2M    |
|          | 45 mm  | Shielded     | 1,5 mm           | E2EL-X1R5E1-L 2M | E2EL-X1R5E2-L 2M | E2EL-X1R5F1-L 2M | E2EL-X1R5F2-L 2M |
|          | 47 mm  | Non-shielded | 2,0 mm           | E2EL-X2ME1-L 2M  | E2EL-X2ME2-L 2M  | E2EL-X2MF1-L 2M  | E2EL-X2MF2-L 2M  |
| M12      | 41 mm  | Shielded     | 2,0 mm           | E2EL-X2E1 2M     | E2EL-X2E2 2M     | E2EL-X2F1 2M     | E2EL-X2F2 2M     |
|          |        | Shielded     | 4,0 mm           | E2EL-X4E1-D 2M   | E2EL-X4E2-D 2M   | E2EL-X4F1-D 2M   | E2EL-X4F2-D 2M   |
|          |        | Non-shielded | 4,0 mm           | E2EL-X4ME1 2M    | E2EL-X4ME2 2M    | E2EL-X4MF1 2M    | E2EL-X4MF2 2M    |
|          | 53 mm  | Shielded     | 2,0 mm           | E2EL-X2E1-L 2M   | E2EL-X2E2-L 2M   | E2EL-X2F1-L 2M   | E2EL-X2F2-L 2M   |
|          |        | Shielded     | 4,0 mm           | E2EL-X4E1-DL 2M  | E2EL-X4E2-DL 2M  | E2EL-X4F1-DL 2M  | E2EL-X4F2-DL 2M  |
|          |        | Non-shielded | 4,0 mm           | E2EL-X4ME1-L 2M  | E2EL-X4ME2-L 2M  | E2EL-X4MF1-L 2M  | E2EL-X4MF2-L 2M  |
| M18      | 40 mm  | Shielded     | 5,0 mm           | E2EL-X5E1 2M     | E2EL-X5E2 2M     | E2EL-X5F1 2M     | E2EL-X5F2 2M     |
|          |        | Shielded     | 8,0 mm           | E2EL-X8E1-D 2M   | E2EL-X8E2-D 2M   | E2EL-X8F1-D 2M   | E2EL-X8F2-D 2M   |
|          |        | Non-shielded | 8,0 mm           | E2EL-X8ME1 2M    | E2EL-X8ME2 2M    | E2EL-X8MF1 2M    | E2EL-X8MF2 2M    |
|          | 73 mm  | Shielded     | 5,0 mm           | E2EL-X5E1-L 2M   | E2EL-X5E2-L 2M   | E2EL-X5F1-L 2M   | E2EL-X5F2-L 2M   |
|          |        | Shielded     | 8,0 mm           | E2EL-X8E1-DL 2M  | E2EL-X8E2-DL 2M  | E2EL-X8F1-DL 2M  | E2EL-X8F2-DL 2M  |
|          |        | Non-shielded | 8,0 mm           | E2EL-X8ME1-L 2M  | E2EL-X8ME2-L 2M  | E2EL-X8MF1-L 2M  | E2EL-X8MF2-L 2M  |
| M30      | 40 mm  | Shielded     | 10,0 mm          | E2EL-X10E1 2M    | E2EL-X10E2 2M    | E2EL-X10F1 2M    | E2EL-X10F2 2M    |
|          |        | Non-shielded | 15,0 mm          | E2EL-X15ME1 2M   | E2EL-X15ME2 2M   | E2EL-X15MF1 2M   | E2EL-X15MF2 2M   |
|          | 80 mm  | Shielded     | 10,0 mm          | E2EL-X10E1-L 2M  | E2EL-X10E2-L 2M  | E2EL-X10F1-L 2M  | E2EL-X10F2-L 2M  |
|          |        | Non-shielded | 15,0 mm          | E2EL-X15ME1-L 2M | E2EL-X15ME2-L 2M | E2EL-X15MF1-L 2M | E2EL-X15MF2-L 2M |

## Stainless steel housing

| Diameter | Length | Mounting | Sensing Distance | Output           |                  |                  |                  |
|----------|--------|----------|------------------|------------------|------------------|------------------|------------------|
|          |        |          |                  | NPN / NO         | NPN / NC         | PNP / NO         | PNP / NC         |
| Ø6,5     | 30 mm  | Shielded | 2,0 mm           | E2EL-C2E1-DS 2M  | E2EL-C2E2-DS 2M  | E2EL-C2F1-DS 2M  | E2EL-C2F2-DS 2M  |
|          | 45 mm  | Shielded | 2,0 mm           | E2EL-C2E1-DSL 2M | E2EL-C2E2-DSL 2M | E2EL-C2F1-DSL 2M | E2EL-C2F2-DSL 2M |
| M8       | 30 mm  | Shielded | 2,0 mm           | E2EL-X2E1-DS 2M  | E2EL-X2E2-DS 2M  | E2EL-X2F1-DS 2M  | E2EL-X2F2-DS 2M  |
|          | 45 mm  | Shielded | 2,0 mm           | E2EL-X2E1-DSL 2M | E2EL-X2E2-DSL 2M | E2EL-X2F1-DSL 2M | E2EL-X2F2-DSL 2M |
| M12      | 41 mm  | Shielded | 4,0 mm           | E2EL-X4E1-DS 2M  | E2EL-X4E2-DS 2M  | E2EL-X4F1-DS 2M  | E2EL-X4F2-DS 2M  |
|          | 53 mm  | Shielded | 4,0 mm           | E2EL-X4E1-DSL 2M | E2EL-X4E2-DSL 2M | E2EL-X4F1-DSL 2M | E2EL-X4F2-DSL 2M |
| M18      | 40 mm  | Shielded | 8,0 mm           | E2EL-X8E1-DS 2M  | E2EL-X8E2-DS 2M  | E2EL-X8F1-DS 2M  | E2EL-X8F2-DS 2M  |
|          | 73 mm  | Shielded | 8,0 mm           | E2EL-X8E1-DSL 2M | E2EL-X8E2-DSL 2M | E2EL-X8F1-DSL 2M | E2EL-X8F2-DSL 2M |

## ■ Plug types

## Brass housing

| Diameter / Connection | Length | Mounting     | Sensing Distance | Output          |                 |                 |                 |
|-----------------------|--------|--------------|------------------|-----------------|-----------------|-----------------|-----------------|
|                       |        |              |                  | NPN / NO        | NPN / NC        | PNP / NO        | PNP / NC        |
| Ø6,5 / Plug M8        | 45 mm  | Shielded     | 1,5 mm           | E2EL-C1R5E1-M3  | E2EL-C1R5E2-M3  | E2EL-C1R5F1-M3  | E2EL-C1R5F2-M3  |
|                       | 47 mm  | Non-shielded | 2,0 mm           | E2EL-C2ME1-M3   | E2EL-C2ME2-M3   | E2EL-C2MF1-M3   | E2EL-C2MF2-M3   |
|                       | 54 mm  | Shielded     | 1,5 mm           | E2EL-C1R5E1-M3L | E2EL-C1R5E2-M3L | E2EL-C1R5F1-M3L | E2EL-C1R5F2-M3L |
|                       | 56 mm  | Non-shielded | 2,0 mm           | E2EL-C2ME1-M3L  | E2EL-C2ME2-M3L  | E2EL-C2MF1-M3L  | E2EL-C2MF2-M3L  |
| M8 / Plug M8          | 45 mm  | Shielded     | 1,5 mm           | E2EL-X1R5E1-M3  | E2EL-X1R5E2-M3  | E2EL-X1R5F1-M3  | E2EL-X1R5F2-M3  |
|                       | 47 mm  | Non-shielded | 2,0 mm           | E2EL-X2ME1-M3   | E2EL-X2ME2-M3   | E2EL-X2MF1-M3   | E2EL-X2MF2-M3   |
|                       | 54 mm  | Shielded     | 1,5 mm           | E2EL-X1R5E1-M3L | E2EL-X1R5E2-M3L | E2EL-X1R5F1-M3L | E2EL-X1R5F2-M3L |
|                       | 56 mm  | Non-shielded | 2,0 mm           | E2EL-X2ME1-M3L  | E2EL-X2ME2-M3L  | E2EL-X2MF1-M3L  | E2EL-X2MF2-M3L  |
| M8 / Plug M12         | 44 mm  | Shielded     | 1,5 mm           | E2EL-X1R5E1-M1  | E2EL-X1R5E2-M1  | E2EL-X1R5F1-M1  | E2EL-X1R5F2-M1  |
|                       | 46 mm  | Non-shielded | 2,0 mm           | E2EL-X2ME1-M1   | E2EL-X2ME2-M1   | E2EL-X2MF1-M1   | E2EL-X2MF2-M1   |
|                       | 60 mm  | Shielded     | 1,5 mm           | E2EL-X1R5E1-M1L | E2EL-X1R5E2-M1L | E2EL-X1R5F1-M1L | E2EL-X1R5F2-M1L |
|                       | 62 mm  | Non-shielded | 2,0 mm           | E2EL-X2ME1-M1L  | E2EL-X2ME2-M1L  | E2EL-X2MF1-M1L  | E2EL-X2MF2-M1L  |
| M12 / Plug M12        | 49 mm  | Shielded     | 2,0 mm           | E2EL-X2E1-M1    | E2EL-X2E2-M1    | E2EL-X2F1-M1    | E2EL-X2F2-M1    |
|                       |        | Shielded     | 4,0 mm           | E2EL-X4E1-DM1   | E2EL-X4E2-DM1   | E2EL-X4F1-DM1   | E2EL-X4F2-DM1   |
|                       |        | Non-shielded | 4,0 mm           | E2EL-X4ME1-M1   | E2EL-X4ME2-M1   | E2EL-X4MF1-M1   | E2EL-X4MF2-M1   |
|                       | 60 mm  | Shielded     | 2,0 mm           | E2EL-X2E1-M1L   | E2EL-X2E2-M1L   | E2EL-X2F1-M1L   | E2EL-X2F2-M1L   |
|                       |        | Shielded     | 4,0 mm           | E2EL-X4E1-DM1L  | E2EL-X4E2-DM1L  | E2EL-X4F1-DM1L  | E2EL-X4F2-DM1L  |
|                       |        | Non-shielded | 4,0 mm           | E2EL-X4ME1-M1L  | E2EL-X4ME2-M1L  | E2EL-X4MF1-M1L  | E2EL-X4MF2-M1L  |
| M18 / Plug M12        | 53 mm  | Shielded     | 5,0 mm           | E2EL-X5E1-M1    | E2EL-X5E2-M1    | E2EL-X5F1-M1    | E2EL-X5F2-M1    |
|                       |        | Shielded     | 8,0 mm           | E2EL-X8E1-DM1   | E2EL-X8E2-DM1   | E2EL-X8F1-DM1   | E2EL-X8F2-DM1   |
|                       |        | Non-shielded | 8,0 mm           | E2EL-X8ME1-M1   | E2EL-X8ME2-M1   | E2EL-X8MF1-M1   | E2EL-X8MF2-M1   |
|                       | 80 mm  | Shielded     | 5,0 mm           | E2EL-X5E1-M1L   | E2EL-X5E2-M1L   | E2EL-X5F1-M1L   | E2EL-X5F2-M1L   |
|                       |        | Shielded     | 8,0 mm           | E2EL-X8E1-DM1L  | E2EL-X8E2-DM1L  | E2EL-X8F1-DM1L  | E2EL-X8F2-DM1L  |
|                       |        | Non-shielded | 8,0 mm           | E2EL-X8ME1-M1L  | E2EL-X8ME2-M1L  | E2EL-X8MF1-M1L  | E2EL-X8MF2-M1L  |
| M30 / Plug M12        | 55 mm  | Shielded     | 10,0 mm          | E2EL-X10E1-M1   | E2EL-X10E2-M1   | E2EL-X10F1-M1   | E2EL-X10F2-M1   |
|                       |        | Non-shielded | 15,0 mm          | E2EL-X15ME1-M1  | E2EL-X15ME2-M1  | E2EL-X15MF1-M1  | E2EL-X15MF2-M1  |
|                       | 80 mm  | Shielded     | 10,0 mm          | E2EL-X10E1-M1L  | E2EL-X10E2-M1L  | E2EL-X10F1-M1L  | E2EL-X10F2-M1L  |
|                       |        | Non-shielded | 15,0 mm          | E2EL-X15ME1-M1L | E2EL-X15ME2-M1L | E2EL-X15MF1-M1L | E2EL-X15MF2-M1L |

## Stainless steel housing

| Diameter / Connection | Length | Mounting | Sensing Distance | Output          |                 |                 |                 |
|-----------------------|--------|----------|------------------|-----------------|-----------------|-----------------|-----------------|
|                       |        |          |                  | NPN / NO        | NPN / NC        | PNP / NO        | PNP / NC        |
| M8 / Plug M8          | 54 mm  | Shielded | 2,0 mm           | E2EL-X2E1-DM3SL | E2EL-X2E2-DM3SL | E2EL-X2F1-DM3SL | E2EL-X2F2-DM3SL |
| M12 / Plug M12        | 49 mm  | Shielded | 4,0 mm           | E2EL-X4E1-DM1S  | E2EL-X4E2-DM1S  | E2EL-X4F1-DM1S  | E2EL-X4F2-DM1S  |
|                       | 60 mm  | Shielded | 4,0 mm           | E2EL-X4E1-DM1SL | E2EL-X4E2-DM1SL | E2EL-X4F1-DM1SL | E2EL-X4F2-DM1SL |
| M18 / Plug M12        | 53 mm  | Shielded | 8,0 mm           | E2EL-X8E1-DM1S  | E2EL-X8E2-DM1S  | E2EL-X8F1-DM1S  | E2EL-X8F2-DM1S  |
|                       | 80 mm  | Shielded | 8,0 mm           | E2EL-X8E1-DM1SL | E2EL-X8E2-DM1SL | E2EL-X8F1-DM1SL | E2EL-X8F2-DM1SL |

# Specifications

## ■ Brass type

| Type  | Ø6,5   |   | M8    |                     | M12     |   | M18     |     | M30     |                                       |         |      |         |  |
|---|--|---|-------|---------------------|---------|---|---------|-----|---------|---------------------------------------|---------|------|---------|--|
| Operating voltage                                   | 10 to 35 VDC   |   |       |                     |         |   |         |     |         |                                       |         |      |         |  |
| Rated supply voltage                                | 24 VDC   |   |       |                     |         |   |         |     |         |                                       |         |      |         |  |
| Current consumption                                 | max. 15 mA at 24 VDC   |   |       |                     |         |   |         |     |         |                                       |         |      |         |  |
| Sensing object                                      | Ferrous metals   |   |       |                     |         |   |         |     |         |                                       |         |      |         |  |
| Mounting ((s)hielded, (n)on-shielded) (see note 1)  | s  | n                                       | s     | n                   | s       | s                                       | n       | s   | s       | n                                     | s       | n    |         |  |
| Operating distance in mm                            | 1,5  | 2,0                                     | 1,5   | 2,0                 | 2,0     | 4,0                                     | 4,0     | 5,0 | 8,0     | 8,0                                   | 10,0    | 15,0 |         |  |
| Tolerance of operating distance                     | ±10%   |   |       |                     |         |   |         |     |         |                                       |         |      |         |  |
| Standard target size in mm (L x W x H in mm, FE 37) | 6,5x6,5x1  |   | 8x8x1 |                     | 12x12x1 |   | 18x18x1 |     | 24x24x1 |                                       | 30x30x1 |      | 45x45x1 |  |
| Differential travel                                 | 1 % ... 15 % of operating distance   |   |       |                     |         |   |         |     |         |                                       |         |      |         |  |
| Max. response frequency in kHz                      | 5,0  |   | 5,0   |                     | 2,0     | 0,6                                     | 1,0     | 0,5 | 0,3     | 0,5                                   | 0,25    | 0,15 |         |  |
| Control output Type                                 | E2EL-... E1 type: NPN-NO<br>E2 type: NPN-NC<br>F1 type: PNP-NO<br>F2 type: PNP-NC          |   |       |                     |         |   |         |     |         |                                       |         |      |         |  |
| Max-Load  | 200 mA   |   |       |                     |         |   |         |     |         |                                       |         |      |         |  |
| Max-on-state Voltage drop                           | 2,5 VDC (at 200mA load current and with 2 m cable)   |   |       |                     |         |   |         |     |         |                                       |         |      |         |  |
| Circuit protection                                  | Reverse polarity, output short-circuit   |   |       |                     |         |   |         |     |         |                                       |         |      |         |  |
| Indicator   | Operating indicator (yellow LED)   |   |       |                     |         |   |         |     |         |                                       |         |      |         |  |
| Ambient temperature                                 | Operating: -25° to 70°C  |   |       |                     |         |   |         |     |         |                                       |         |      |         |  |
| Humidity  | 35 to 95 % RH  |   |       |                     |         |   |         |     |         |                                       |         |      |         |  |
| Influence of temperature                            | ± 10 % max. of Sn at 23°C in temperature range of -25° to 70°C                             |   |       |                     |         |   |         |     |         |                                       |         |      |         |  |
| Dielectric strength                                 | 1.500 VAC, 50/60 Hz for 1 min. between current carry parts and case                        |   |       |                     |         |   |         |     |         |                                       |         |      |         |  |
| Electromagnetic compatibility EMC                   | EN 60947-5-2   |   |       |                     |         |   |         |     |         |                                       |         |      |         |  |
| Vibration resistance                                | Destruction: 10 to 70 Hz, 1,5 mm double amplitude for 1 hour each in X, Y and Z directions |   |       |                     |         |   |         |     |         |                                       |         |      |         |  |
| Shock resistance                                    | Destruction: 300 m/s <sup>2</sup> (approx. 30 G) for 6 times each in X, Y and Z directions |   |       |                     |         |   |         |     |         |                                       |         |      |         |  |
| Enclosure rating                                    | IP 67 (EN 60947-1)   |   |       |                     |         |   |         |     |         |                                       |         |      |         |  |
| Connection (see note 2)                             | Pre-wired  | 2 m PVC-cable, 3 x 0,14 mm <sup>2</sup> |       |                     |         | 2 m PVC-cable, 3 x 0,25 mm <sup>2</sup> |         |     |         | 2m PVC-cable, 3 x 0,5 mm <sup>2</sup> |         |      |         |  |
|   | Connector  | M8 plug                                 |       | M8 plug<br>M12 plug |         | M12 plug                                |         |     |         |                                       |         |      |         |  |
| Weight in g   | Pre-wired  | long                                    | 45    | 50                  | 75      | 115                                     |         | 260 |         |                                       |         |      |         |  |
|   |  | short                                   | 43    | 48                  | 70      | 100                                     |         | 200 |         |                                       |         |      |         |  |
|   | Connector  | long                                    | 10    | 15                  | 25      | 60                                      |         | 155 |         |                                       |         |      |         |  |
|   |  | short                                   | 8     | 13                  | 20      | 50                                      |         | 110 |         |                                       |         |      |         |  |
| Material  | Case   | Brass                                   |       |                     |         |   |         |     |         |                                       |         |      |         |  |
|   | Sensing face   | PBTP                                    |       |                     |         |   |         |     |         |                                       |         |      |         |  |

- Note:** 1. For detailed mounting instruction please refer to page 11.  
2. PUR cable and different length on request.

## ■ Stainless steel type

| Type   | Ø6,5   | M8                                      | M12     | M18                                     |    |     |
|--|--|---|---------|---|----|-----|
| Operating voltage                                | 10 to 35 VDC   |   |         |   |    |     |
| Rated supply voltage                             | 24 VDC   |   |         |   |    |     |
| Current consumption                              | max. 15 mA at 24 VDC   |   |         |   |    |     |
| Mounting (see note 1)                            | Shielded   |   |         |   |    |     |
| Sensing object                                   | Ferrous metals   |   |         |   |    |     |
| Operating distance in mm                         | 2,0  | 2,0                                     | 4,0     | 8,0                                     |    |     |
| Tolerance of operating distance                  | ±10%   |   |         |   |    |     |
| Standard target size<br>(L x W x H in mm, FE 37) | 6,5x6,5x1  | 8x8x1                                   | 12x12x1 | 24x24x1                                 |    |     |
| Differential travel                              | 1 % ... 15 % of operating distance   |   |         |   |    |     |
| Max. response frequency in kHz                   | 4,0  | 4,0                                     | 0,6     | 0,25                                    |    |     |
| Control output Type                              | E2EL-... E1 type: NPN-NO<br>E2 type: NPN-NC<br>F1 type: PNP-NO<br>F2 type: PNP-NC          |   |         |   |    |     |
| Max-Load   | 200 mA   |   |         |   |    |     |
| Max-on-state Voltage drop                        | 2,5 VDC (at 200mA load current and with 2 m cable)   |   |         |   |    |     |
| Circuit protection                               | Reverse polarity, output short-circuit   |   |         |   |    |     |
| Indicator  | Operating indicator (yellow LED)   |   |         |   |    |     |
| Ambient temperature                              | Operating: -25° to 70°C  |   |         |   |    |     |
| Humidity   | 35 to 95 % RH  |   |         |   |    |     |
| Influence of temperature                         | ± 10 % max. of Sn at 23°C in temperature range of -25° to 70°C                             |   |         |   |    |     |
| Dielectric strength                              | 1.500 VAC, 50/60 Hz for 1 min. between current carry parts and case                        |   |         |   |    |     |
| Electromagnetic compatibility EMC                | EN 60947-5-2   |   |         |   |    |     |
| Vibration resistance                             | Destruction: 10 to 70 Hz, 1,5 mm double amplitude for 1 hour each in X, Y and Z directions |   |         |   |    |     |
| Shock resistance                                 | Destruction: 300 m/s <sup>2</sup> (approx. 30 G) for 6 times each in X, Y and Z directions |   |         |   |    |     |
| Enclosure rating                                 | IP 67 (EN 60947-1)   |   |         |   |    |     |
| Connection<br>(see note 2)                       | Pre-wired  | 2 m PVC-cable, 3 x 0,14 mm <sup>2</sup> |         | 2 m PVC-cable, 3 x 0,25 mm <sup>2</sup> |    |     |
|  | Connector  | -                                       | M8 plug | M12 plug                                |    |     |
| Weight in g                                      | Pre-wired  | long                                    | 45      | 50                                      | 75 | 120 |
|  |  | short                                   | 43      | 48                                      | 70 | 105 |
|  | Connector  | long                                    | -       | 10                                      | 25 | 65  |
|  |  | short                                   | -       | -                                       | 20 | 55  |
| Material   | Case   | stainless steel 1.4305 / AISI 303       |         |   |    |     |
|  | Sensing face   | PBTP                                    |         |   |    |     |

- Note:** 1. For detailed mounting instruction please refer to page 11.  
2. PUR cable and different length on request.

# Engineering Data

## Standardized characteristic for lateral approach

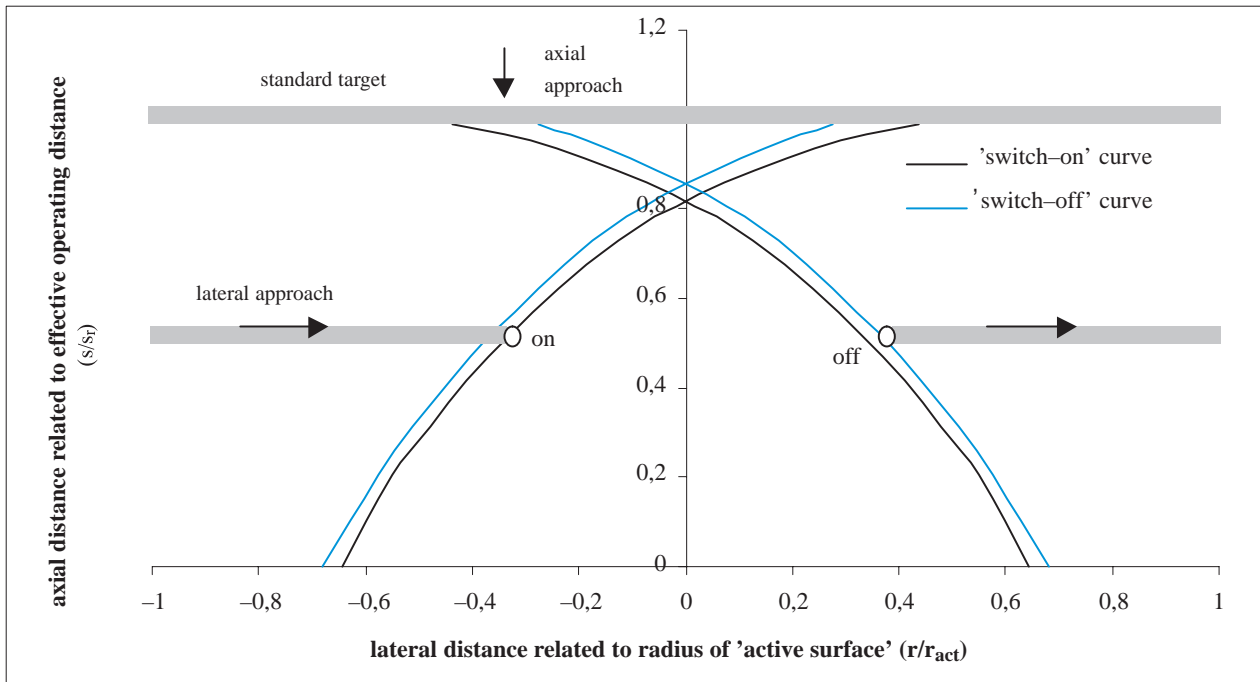

## Output Circuit Diagram and Timing Chart

**E2EL-X□E□**  
NPN Output

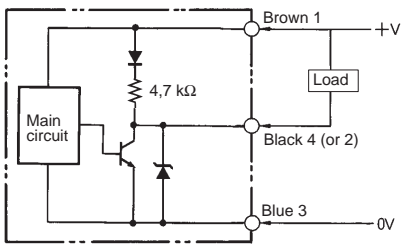

**E2EL-X□F□**  
PNP Output

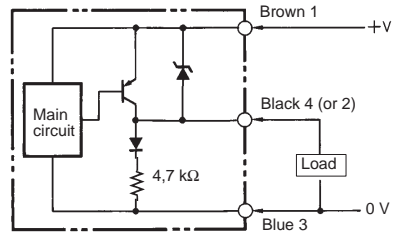

**E2EL-X□E□**  
NPN Output

|                  | NO  | NC      |
|------------------|-----|---------|
| Sensing object   | Yes | No      |
| Yellow indicator | Lit | Not lit |
| Control output   | ON  | OFF     |

**E2EL-X□F□**  
PNP Output

|                  | NO  | NC      |
|------------------|-----|---------|
| Sensing object   | Yes | No      |
| Yellow indicator | Lit | Not lit |
| Control output   | ON  | OFF     |

### Pin Arrangement at Connector Types

#### 1. Connector M8 (viewed to plug pins)

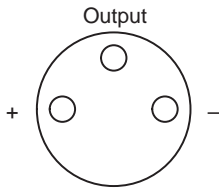

#### 2. Connector M12 (viewed to plug pins)

**NO**

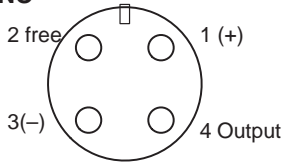

**NC**

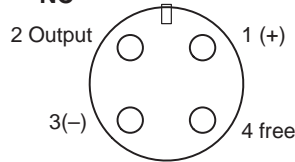

## Dimensions

- Note:**
- All units are in millimeters unless otherwise indicated.
  - Unless otherwise specified, a tolerance of  $\pm 0.4$  mm applies to all dimensions. Values in parentheses () are cumulative values and may exceed tolerance of  $\pm 0.4$  mm.
  - The square  $\square$  in the models represents the output configuration. Refer to *Ordering Information*.

### Cable Types

**E2EL-C1□R5 2M, E2EL-C2□-DS 2M**

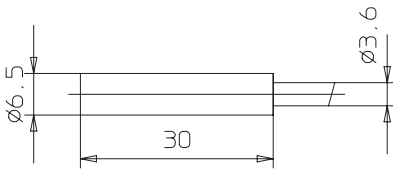

**E2EL-C2M□ 2M**

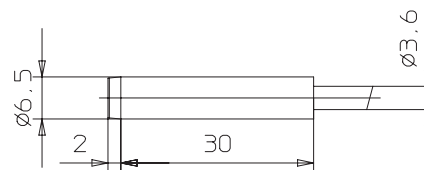

**E2EL-C1R5□-L 2M, E2EL-C2□-DSL 2M**

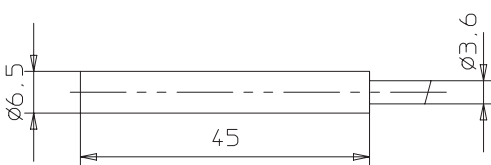

**E2EL-C2M□-L 2M**

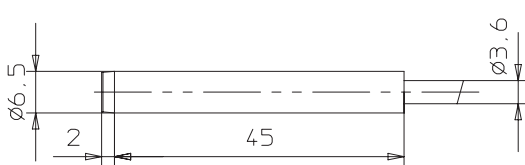

**E2EL-X1R5□ 2M, E2EL-X2□-DS 2M**

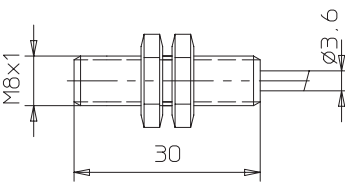

**E2EL-X2M□ 2M**

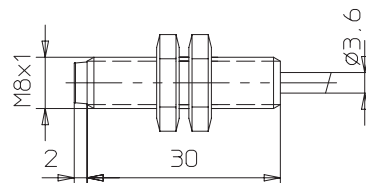

**E2EL-X1R5□-L 2M, E2EL-X2□-DSL 2M**

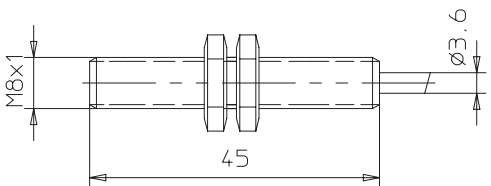

**E2EL-X2M□-L 2M**

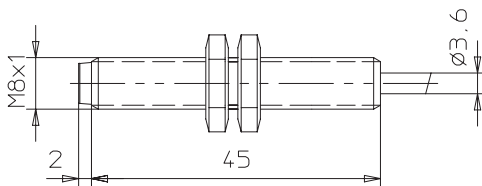

E2EL-X2□ 2M, E2EL-X4□-D 2M, E2EL-X4□-DS 2M

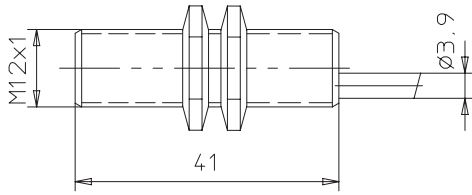

E2EL-X4M□ 2M

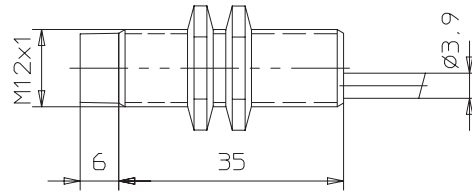

E2EL-X2□-L 2M, E2EL-X4□-DL 2M, E2EL-X4□-DSL 2M

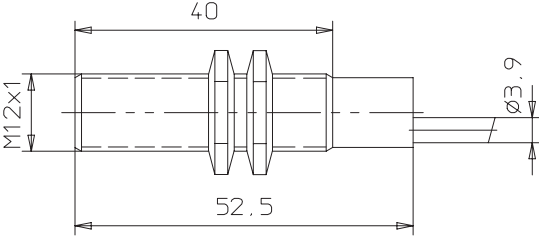

E2EL-X4M□-L 2M

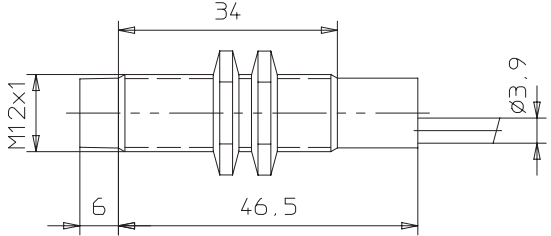

E2EL-X5□ 2M, E2EL-X8□-D 2M, E2EL-X8□-DS 2M

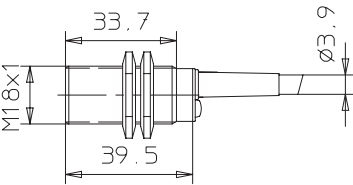

E2EL-X8M□ 2M

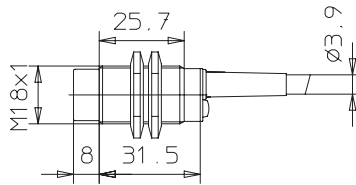

E2EL-X5□-L 2M, E2EL-X8□-DL 2M, E2EL-X8□-DSL 2M

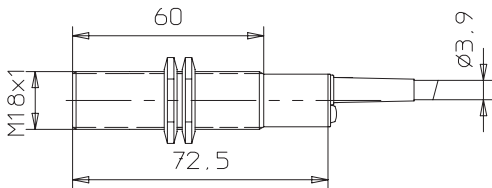

E2EL-X8M□-L 2M

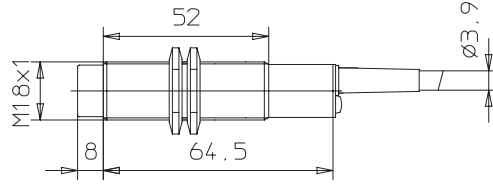

E2EL-X10□ 2M

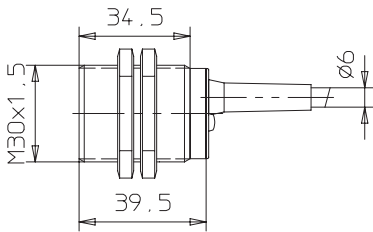

E2EL-X15M□ 2M

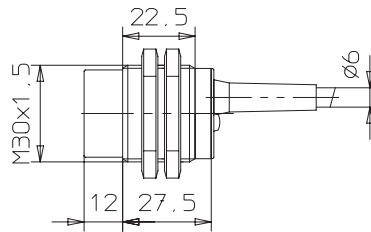

E2EL-X10□-L 2M

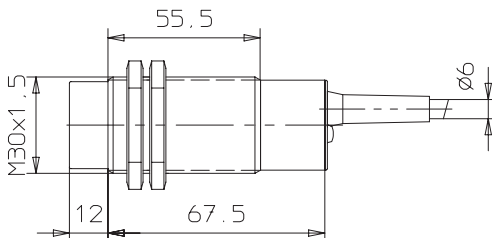

E2EL-X15M□-L 2M

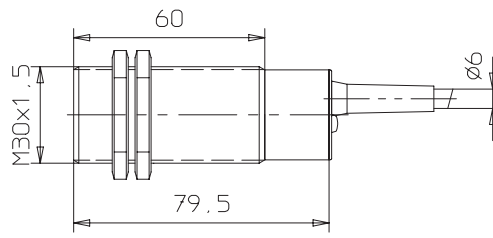

Plug Types

E2EL-C1R5□-M3

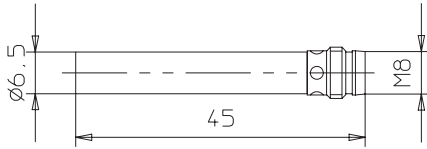

E2EL-C2M□-M3

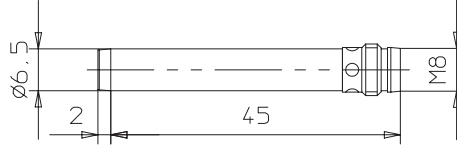

E2EL-C1R5□-M3L

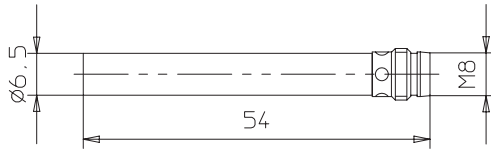

E2EL-C2M□-M3L

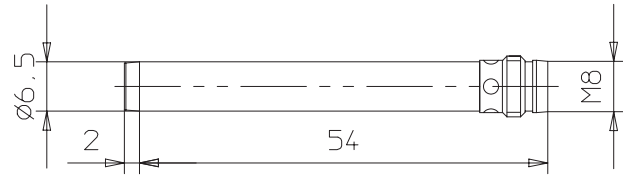

E2EL-X1R5□-M3

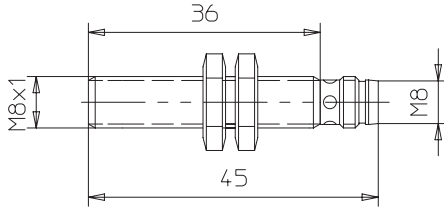

E2EL-X2M□-M3

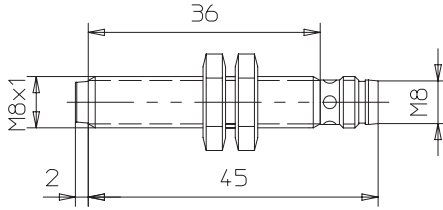

E2EL-X1R5□-M3L, E2EL-X2□DM3S

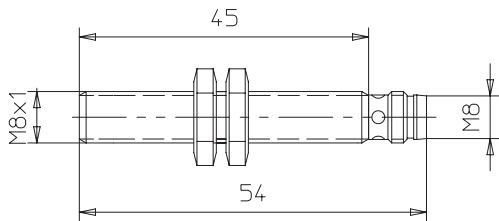

E2EL-X2M□-M3L

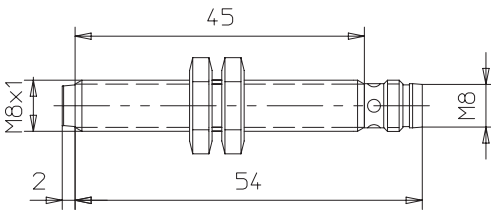

E2EL-X1R5□-M1

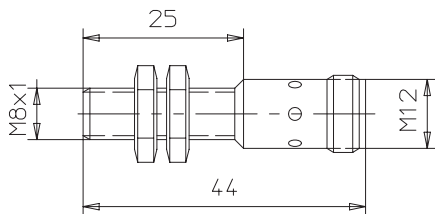

E2EL-X2M□-M1

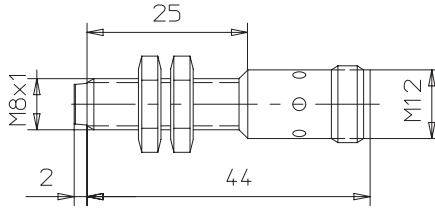

E2EL-X1R5□-M1L

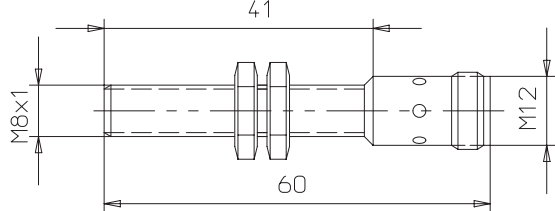

E2EL-X2M□-M1L

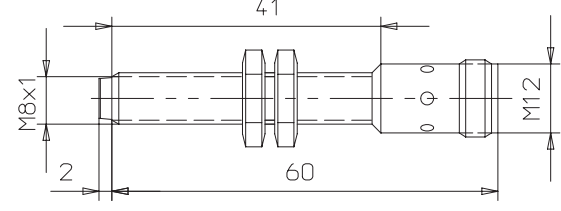

E2EL-X2□-M1, E2EL-X4□-DM1, E2EL-X4□-DM1S

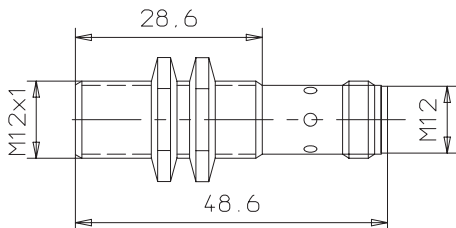

E2EL-X4M□-M1

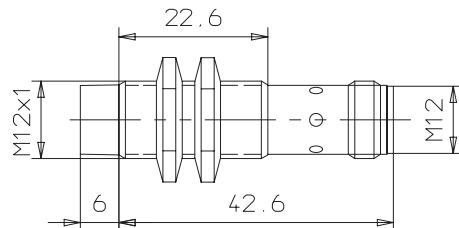



E2EL-X2□-M1L, E2EL-X4□-DM1L, E2EL-X4□-DM1SL

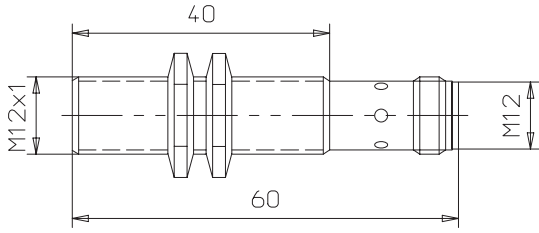

E2EL-X4M□-M1L

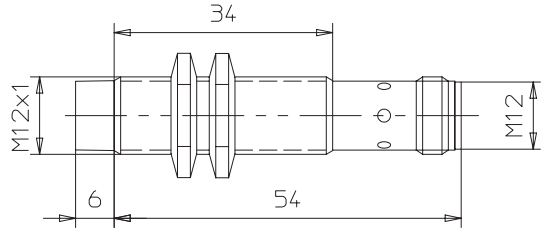

E2EL-X5□-M1, E2EL-X8□-DM1, E2EL-X8□-DM1S

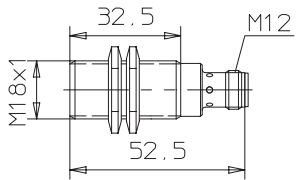

E2EL-X8M□-M1

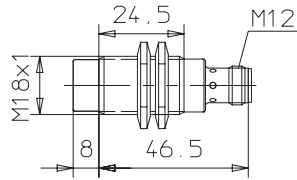

E2EL-X5□-M1L, E2EL-X8□-DM1L, E2EL-X8□-DM1SL

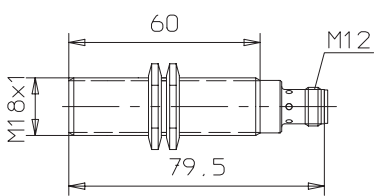

E2EL-X8M□-M1L

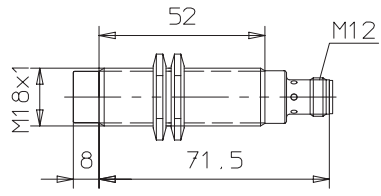

E2EL-X10□-M1

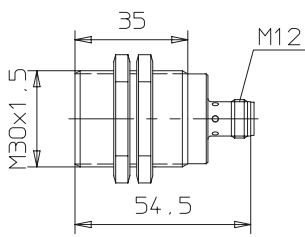

E2EL-X15M□-M1

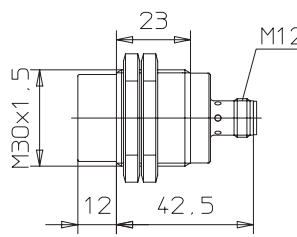

E2EL-X10□-M1L

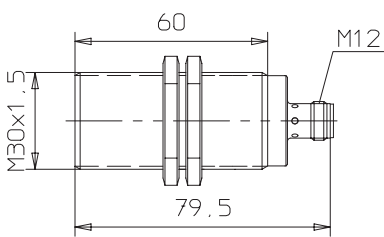

E2EL-X15M□-M1L

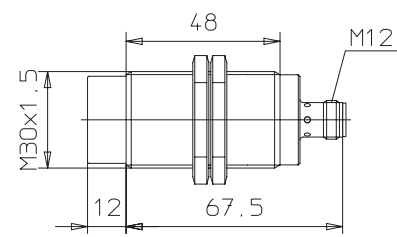

# Installation

## ■ Caution

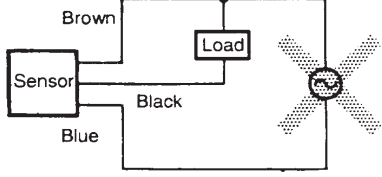
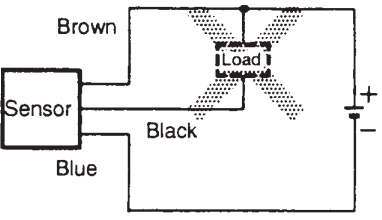
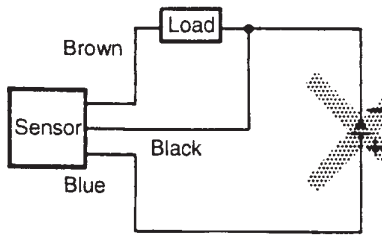
| Item   | Examples   |
|--|--|
| <p><b>Power Supply</b></p> <p>Do not impose an excessive voltage on the E2EL, otherwise it may explode or burn.</p> <p>Do not impose 24 VAC on any E2EL model, otherwise it may explode or burn.</p>   |  |
| <p><b>Load short-circuit</b></p> <p>Do not short-circuit the load, or the E2EL may explode or burn.</p> <p>The E2EL's short-circuit protection function is valid, if the polarity of the supply voltage imposed is incorrect and within the rated voltage range.</p> |  |
| <p><b>Wiring</b></p> <p>Be sure to wire the E2EL and load correctly, otherwise it may explode or burn.</p>   |  |

## ■ Correct Use

### Installation

#### Power Reset Time

The Proximity Sensor is ready to operate within 100 ms after power is supplied. If power supplies are connected to the Proximity Sensor and load respectively, be sure to supply power to the Proximity Sensor before supplying power to the load.

#### Power OFF

The Proximity Sensor may output a pulse signal when it is turned off. Therefore, it is recommended to turn off the load before turning off the Proximity Sensor.

#### Power Supply Transformer

When using a DC power supply, make sure that the DC power supply has an insulated transformer. Do not use a DC power supply with an auto-transformer.

#### Sensing Object

Metal Coating:

The sensing distance of the Proximity Sensor vary with the metal coating on sensing objects.

### Wiring

#### High-tension Lines

Wiring through Metal Conduit

If there a power or high-tension line near the cord of the Proximity Sensor, wire the cord through an independent metal conduit to prevent against Proximity Sensor damage or malfunctioning.

#### Core Tractive Force

Do not pull cords with the tractive force exceeding the following:  
pull force (N) = 20 x cable diameter ( mm)

#### Mounting

The Proximity Sensor must not be subjected to excessive shock with a hammer when it is installed, otherwise the Proximity Sensor may be damaged or lose the water-resistivity.

### Environment

#### Water-Resistivity

Do not use the Proximity Sensor underwater, outdoors or in the rain.

#### Operating Environment

Be sure to use the Proximity Sensor within operating ambient temperature range and do not use the Proximity Sensor outdoors so that its reliability and life expectancy can be maintained. Although the Proximity Sensor is water resistive, a cover to protect the Proximity Sensor from water or soluble machining oil is recommended so that its reliability and life expectancy can be maintained. Do not use the Proximity Sensor in an environment with chemical gas (e. G., strong alkaline or acid gases including nitric, chromic, and concentrated sulfuric acid gases).

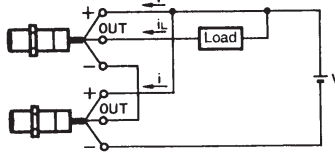
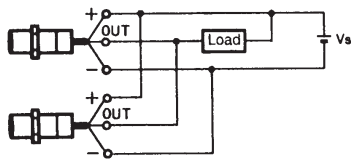
| Item                               | Examples  | Item   |
|------------------------------------|---|--|
| <b>AND</b><br>(serial connection)  | <p style="text-align: center;"><b>Correct</b></p>  | <p>The Sensors connected together must satisfy the following conditions:</p> $i_L + (N-1) \times i = \text{Upper-limit of control output of each Sensor}$ $V_S - N \times V_R = \text{Load operating voltage}$ <p> <math>N =</math> No. of Sensors<br/> <math>V_R =</math> Residual voltage of each Sensor<br/> <math>V_S =</math> Supply voltage<br/> <math>i =</math> Current consumption of the Sensor<br/> <math>i_L =</math> Load current                 </p> <p>If the MY Relay, which operate at 24 VDC, is used as a load for example, a maximum of two Proximity Sensors can be connected to the load.</p> |
| <b>OR</b><br>(parallel connection) | <p style="text-align: center;"><b>Correct</b></p>  | <p>The number of Sensors connected in parallel varies with the Proximity Sensor model.</p>   |

**Effects of Surrounding Metal**

**Shielded types:**

Shielded types allow direct installation on metal plates in an embedded manner without performance change. A minimum distance of  $3s_n$  is required between the active surface and a metallic surface in front of the device. (Fig. 1).

For SUS shielded types the following minimum distances are required to avoid performance change (see Fig.2 and table below):

| Shielded SUS Types | Free zone |
|--------------------|-----------|
| E2EL-C2□-DS        | 0,5 mm    |
| E2EL-X2□-DS        | 0,5 mm    |
| E2EL-X4□-D□S       | 1,0 mm    |
| E2EL-X8□-D□S       | 2,0 mm    |

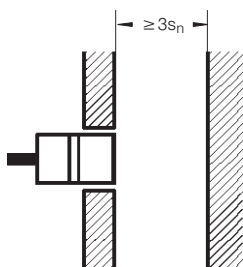

**Fig.1: Shielded type (except SUS)**

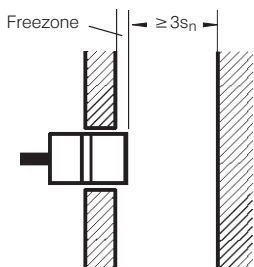

**Fig.2: Shielded SUS type**

**Non-shielded types:**

Installation of non-shielded types in metal require the minimum distances according to Fig. 3.

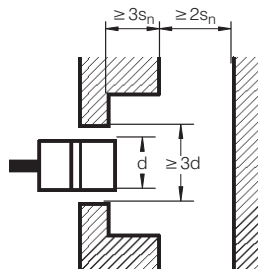

**Fig.3: Non-shielded type**

**In the interest of product improvement, specifications are subject to change without notice.**

**ALL DIMENSIONS SHOWN ARE IN MILLIMETERS.**

To convert millimeters into inches, multiply by 0.03937. To convert grams into ounces, multiply by 0.03527.

OMRON EUROPE B.V.  
Sensor Business Unit  
Carl-Benz-Straße 4  
D-71154 NUFRINGEN (GERMANY)  
Phone: +49-70 32-811-0  
Fax: +49-70 32-811-199

Cat. No. D093-E2-1

Компания «Океан Электроники» предлагает заключение долгосрочных отношений при поставках импортных электронных компонентов на взаимовыгодных условиях!

Наши преимущества:

- Поставка оригинальных импортных электронных компонентов напрямую с производств Америки, Европы и Азии, а так же с крупнейших складов мира;
- Широкая линейка поставок активных и пассивных импортных электронных компонентов (более 30 млн. наименований);
- Поставка сложных, дефицитных, либо снятых с производства позиций;
- Оперативные сроки поставки под заказ (от 5 рабочих дней);
- Экспресс доставка в любую точку России;
- Помощь Конструкторского Отдела и консультации квалифицированных инженеров;
- Техническая поддержка проекта, помощь в подборе аналогов, поставка прототипов;
- Поставка электронных компонентов под контролем ВП;
- Система менеджмента качества сертифицирована по Международному стандарту ISO 9001;
- При необходимости вся продукция военного и аэрокосмического назначения проходит испытания и сертификацию в лаборатории (по согласованию с заказчиком);
- Поставка специализированных компонентов военного и аэрокосмического уровня качества (Xilinx, Altera, Analog Devices, Intersil, Interpoint, Microsemi, Actel, Aeroflex, Peregrine, VPT, Syfer, Eurofarad, Texas Instruments, MS Kennedy, Miteq, Cobham, E2V, MA-COM, Hittite, Mini-Circuits, General Dynamics и др.);

Компания «Океан Электроники» является официальным дистрибьютором и эксклюзивным представителем в России одного из крупнейших производителей разъемов военного и аэрокосмического назначения «JONHON», а так же официальным дистрибьютором и эксклюзивным представителем в России производителя высокотехнологичных и надежных решений для передачи СВЧ сигналов «FORSTAR».



## JONHON

«JONHON» (основан в 1970 г.)

Разъемы специального, военного и аэрокосмического назначения:

(Применяются в военной, авиационной, аэрокосмической, морской, железнодорожной, горно- и нефтедобывающей отраслях промышленности)

«FORSTAR» (основан в 1998 г.)

ВЧ соединители, коаксиальные кабели, кабельные сборки и микроволновые компоненты:

(Применяются в телекоммуникациях гражданского и специального назначения, в средствах связи, РЛС, а так же военной, авиационной и аэрокосмической отраслях промышленности).



Телефон: 8 (812) 309-75-97 (многоканальный)

Факс: 8 (812) 320-03-32

Электронная почта: [ocean@oceanchips.ru](mailto:ocean@oceanchips.ru)

Web: <http://oceanchips.ru/>

Адрес: 198099, г. Санкт-Петербург, ул. Калинина, д. 2, корп. 4, лит. А