

A new series of easy-to-use models for standard- and double-distance

- Stainless steel and brass housing
- Two housing length for each type
- Pre-wired and Plug-in connector types
- Short-circuit protection and reverse polarity protection



Ordering Information

■ Cable types

Brass housing

Diameter	Length	Mounting	Sensing Distance	Output			
				NPN / NO	NPN / NC	PNP / NO	PNP / NC
Ø6,5	30 mm	Shielded	1,5 mm	E2EL-C1R5E1 2M	E2EL-C1R5E2 2M	E2EL-C1R5F1 2M	E2EL-C1R5F2 2M
	32 mm	Non-shielded	2,0 mm	E2EL-C2ME1 2M	E2EL-C2ME2 2M	E2EL-C2MF1 2M	E2EL-C2MF2 2M
	45 mm	Shielded	1,5 mm	E2EL-C1R5E1-L 2M	E2EL-C1R5E2-L 2M	E2EL-C1R5F1-L 2M	E2EL-C1R5F2-L 2M
	47 mm	Non-shielded	2,0 mm	E2EL-C2ME1-L 2M	E2EL-C2ME2-L 2M	E2EL-C2MF1-L 2M	E2EL-C2MF2-L 2M
M8	30 mm	Shielded	1,5 mm	E2EL-X1R5E1 2M	E2EL-X1R5E2 2M	E2EL-X1R5F1 2M	E2EL-X1R5F2 2M
	32 mm	Non-shielded	2,0 mm	E2EL-X2ME1 2M	E2EL-X2ME2 2M	E2EL-X2MF1 2M	E2EL-X2MF2 2M
	45 mm	Shielded	1,5 mm	E2EL-X1R5E1-L 2M	E2EL-X1R5E2-L 2M	E2EL-X1R5F1-L 2M	E2EL-X1R5F2-L 2M
	47 mm	Non-shielded	2,0 mm	E2EL-X2ME1-L 2M	E2EL-X2ME2-L 2M	E2EL-X2MF1-L 2M	E2EL-X2MF2-L 2M
M12	41 mm	Shielded	2,0 mm	E2EL-X2E1 2M	E2EL-X2E2 2M	E2EL-X2F1 2M	E2EL-X2F2 2M
		Shielded	4,0 mm	E2EL-X4E1-D 2M	E2EL-X4E2-D 2M	E2EL-X4F1-D 2M	E2EL-X4F2-D 2M
		Non-shielded	4,0 mm	E2EL-X4ME1 2M	E2EL-X4ME2 2M	E2EL-X4MF1 2M	E2EL-X4MF2 2M
	53 mm	Shielded	2,0 mm	E2EL-X2E1-L 2M	E2EL-X2E2-L 2M	E2EL-X2F1-L 2M	E2EL-X2F2-L 2M
		Shielded	4,0 mm	E2EL-X4E1-DL 2M	E2EL-X4E2-DL 2M	E2EL-X4F1-DL 2M	E2EL-X4F2-DL 2M
		Non-shielded	4,0 mm	E2EL-X4ME1-L 2M	E2EL-X4ME2-L 2M	E2EL-X4MF1-L 2M	E2EL-X4MF2-L 2M
M18	40 mm	Shielded	5,0 mm	E2EL-X5E1 2M	E2EL-X5E2 2M	E2EL-X5F1 2M	E2EL-X5F2 2M
		Shielded	8,0 mm	E2EL-X8E1-D 2M	E2EL-X8E2-D 2M	E2EL-X8F1-D 2M	E2EL-X8F2-D 2M
		Non-shielded	8,0 mm	E2EL-X8ME1 2M	E2EL-X8ME2 2M	E2EL-X8MF1 2M	E2EL-X8MF2 2M
	73 mm	Shielded	5,0 mm	E2EL-X5E1-L 2M	E2EL-X5E2-L 2M	E2EL-X5F1-L 2M	E2EL-X5F2-L 2M
		Shielded	8,0 mm	E2EL-X8E1-DL 2M	E2EL-X8E2-DL 2M	E2EL-X8F1-DL 2M	E2EL-X8F2-DL 2M
		Non-shielded	8,0 mm	E2EL-X8ME1-L 2M	E2EL-X8ME2-L 2M	E2EL-X8MF1-L 2M	E2EL-X8MF2-L 2M
M30	40 mm	Shielded	10,0 mm	E2EL-X10E1 2M	E2EL-X10E2 2M	E2EL-X10F1 2M	E2EL-X10F2 2M
		Non-shielded	15,0 mm	E2EL-X15ME1 2M	E2EL-X15ME2 2M	E2EL-X15MF1 2M	E2EL-X15MF2 2M
	80 mm	Shielded	10,0 mm	E2EL-X10E1-L 2M	E2EL-X10E2-L 2M	E2EL-X10F1-L 2M	E2EL-X10F2-L 2M
		Non-shielded	15,0 mm	E2EL-X15ME1-L 2M	E2EL-X15ME2-L 2M	E2EL-X15MF1-L 2M	E2EL-X15MF2-L 2M

Stainless steel housing

Diameter	Length	Mounting	Sensing Distance	Output			
				NPN / NO	NPN / NC	PNP / NO	PNP / NC
Ø6,5	30 mm	Shielded	2,0 mm	E2EL-C2E1-DS 2M	E2EL-C2E2-DS 2M	E2EL-C2F1-DS 2M	E2EL-C2F2-DS 2M
	45 mm	Shielded	2,0 mm	E2EL-C2E1-DSL 2M	E2EL-C2E2-DSL 2M	E2EL-C2F1-DSL 2M	E2EL-C2F2-DSL 2M
M8	30 mm	Shielded	2,0 mm	E2EL-X2E1-DS 2M	E2EL-X2E2-DS 2M	E2EL-X2F1-DS 2M	E2EL-X2F2-DS 2M
	45 mm	Shielded	2,0 mm	E2EL-X2E1-DSL 2M	E2EL-X2E2-DSL 2M	E2EL-X2F1-DSL 2M	E2EL-X2F2-DSL 2M
M12	41 mm	Shielded	4,0 mm	E2EL-X4E1-DS 2M	E2EL-X4E2-DS 2M	E2EL-X4F1-DS 2M	E2EL-X4F2-DS 2M
	53 mm	Shielded	4,0 mm	E2EL-X4E1-DSL 2M	E2EL-X4E2-DSL 2M	E2EL-X4F1-DSL 2M	E2EL-X4F2-DSL 2M
M18	40 mm	Shielded	8,0 mm	E2EL-X8E1-DS 2M	E2EL-X8E2-DS 2M	E2EL-X8F1-DS 2M	E2EL-X8F2-DS 2M
	73 mm	Shielded	8,0 mm	E2EL-X8E1-DSL 2M	E2EL-X8E2-DSL 2M	E2EL-X8F1-DSL 2M	E2EL-X8F2-DSL 2M

■ Plug types

Brass housing

Diameter / Connection	Length	Mounting	Sensing Distance	Output			
				NPN / NO	NPN / NC	PNP / NO	PNP / NC
Ø6,5 / Plug M8	45 mm	Shielded	1,5 mm	E2EL-C1R5E1-M3	E2EL-C1R5E2-M3	E2EL-C1R5F1-M3	E2EL-C1R5F2-M3
	47 mm	Non-shielded	2,0 mm	E2EL-C2ME1-M3	E2EL-C2ME2-M3	E2EL-C2MF1-M3	E2EL-C2MF2-M3
	54 mm	Shielded	1,5 mm	E2EL-C1R5E1-M3L	E2EL-C1R5E2-M3L	E2EL-C1R5F1-M3L	E2EL-C1R5F2-M3L
	56 mm	Non-shielded	2,0 mm	E2EL-C2ME1-M3L	E2EL-C2ME2-M3L	E2EL-C2MF1-M3L	E2EL-C2MF2-M3L
M8 / Plug M8	45 mm	Shielded	1,5 mm	E2EL-X1R5E1-M3	E2EL-X1R5E2-M3	E2EL-X1R5F1-M3	E2EL-X1R5F2-M3
	47 mm	Non-shielded	2,0 mm	E2EL-X2ME1-M3	E2EL-X2ME2-M3	E2EL-X2MF1-M3	E2EL-X2MF2-M3
	54 mm	Shielded	1,5 mm	E2EL-X1R5E1-M3L	E2EL-X1R5E2-M3L	E2EL-X1R5F1-M3L	E2EL-X1R5F2-M3L
	56 mm	Non-shielded	2,0 mm	E2EL-X2ME1-M3L	E2EL-X2ME2-M3L	E2EL-X2MF1-M3L	E2EL-X2MF2-M3L
M8 / Plug M12	44 mm	Shielded	1,5 mm	E2EL-X1R5E1-M1	E2EL-X1R5E2-M1	E2EL-X1R5F1-M1	E2EL-X1R5F2-M1
	46 mm	Non-shielded	2,0 mm	E2EL-X2ME1-M1	E2EL-X2ME2-M1	E2EL-X2MF1-M1	E2EL-X2MF2-M1
	60 mm	Shielded	1,5 mm	E2EL-X1R5E1-M1L	E2EL-X1R5E2-M1L	E2EL-X1R5F1-M1L	E2EL-X1R5F2-M1L
	62 mm	Non-shielded	2,0 mm	E2EL-X2ME1-M1L	E2EL-X2ME2-M1L	E2EL-X2MF1-M1L	E2EL-X2MF2-M1L
M12 / Plug M12	49 mm	Shielded	2,0 mm	E2EL-X2E1-M1	E2EL-X2E2-M1	E2EL-X2F1-M1	E2EL-X2F2-M1
		Shielded	4,0 mm	E2EL-X4E1-DM1	E2EL-X4E2-DM1	E2EL-X4F1-DM1	E2EL-X4F2-DM1
		Non-shielded	4,0 mm	E2EL-X4ME1-M1	E2EL-X4ME2-M1	E2EL-X4MF1-M1	E2EL-X4MF2-M1
	60 mm	Shielded	2,0 mm	E2EL-X2E1-M1L	E2EL-X2E2-M1L	E2EL-X2F1-M1L	E2EL-X2F2-M1L
		Shielded	4,0 mm	E2EL-X4E1-DM1L	E2EL-X4E2-DM1L	E2EL-X4F1-DM1L	E2EL-X4F2-DM1L
		Non-shielded	4,0 mm	E2EL-X4ME1-M1L	E2EL-X4ME2-M1L	E2EL-X4MF1-M1L	E2EL-X4MF2-M1L
M18 / Plug M12	53 mm	Shielded	5,0 mm	E2EL-X5E1-M1	E2EL-X5E2-M1	E2EL-X5F1-M1	E2EL-X5F2-M1
		Shielded	8,0 mm	E2EL-X8E1-DM1	E2EL-X8E2-DM1	E2EL-X8F1-DM1	E2EL-X8F2-DM1
		Non-shielded	8,0 mm	E2EL-X8ME1-M1	E2EL-X8ME2-M1	E2EL-X8MF1-M1	E2EL-X8MF2-M1
	80 mm	Shielded	5,0 mm	E2EL-X5E1-M1L	E2EL-X5E2-M1L	E2EL-X5F1-M1L	E2EL-X5F2-M1L
		Shielded	8,0 mm	E2EL-X8E1-DM1L	E2EL-X8E2-DM1L	E2EL-X8F1-DM1L	E2EL-X8F2-DM1L
		Non-shielded	8,0 mm	E2EL-X8ME1-M1L	E2EL-X8ME2-M1L	E2EL-X8MF1-M1L	E2EL-X8MF2-M1L
M30 / Plug M12	55 mm	Shielded	10,0 mm	E2EL-X10E1-M1	E2EL-X10E2-M1	E2EL-X10F1-M1	E2EL-X10F2-M1
		Non-shielded	15,0 mm	E2EL-X15ME1-M1	E2EL-X15ME2-M1	E2EL-X15MF1-M1	E2EL-X15MF2-M1
	80 mm	Shielded	10,0 mm	E2EL-X10E1-M1L	E2EL-X10E2-M1L	E2EL-X10F1-M1L	E2EL-X10F2-M1L
		Non-shielded	15,0 mm	E2EL-X15ME1-M1L	E2EL-X15ME2-M1L	E2EL-X15MF1-M1L	E2EL-X15MF2-M1L

Stainless steel housing

Diameter / Connection	Length	Mounting	Sensing Distance	Output			
				NPN / NO	NPN / NC	PNP / NO	PNP / NC
M8 / Plug M8	54 mm	Shielded	2,0 mm	E2EL-X2E1-DM3SL	E2EL-X2E2-DM3SL	E2EL-X2F1-DM3SL	E2EL-X2F2-DM3SL
M12 / Plug M12	49 mm	Shielded	4,0 mm	E2EL-X4E1-DM1S	E2EL-X4E2-DM1S	E2EL-X4F1-DM1S	E2EL-X4F2-DM1S
	60 mm	Shielded	4,0 mm	E2EL-X4E1-DM1SL	E2EL-X4E2-DM1SL	E2EL-X4F1-DM1SL	E2EL-X4F2-DM1SL
M18 / Plug M12	53 mm	Shielded	8,0 mm	E2EL-X8E1-DM1S	E2EL-X8E2-DM1S	E2EL-X8F1-DM1S	E2EL-X8F2-DM1S
	80 mm	Shielded	8,0 mm	E2EL-X8E1-DM1SL	E2EL-X8E2-DM1SL	E2EL-X8F1-DM1SL	E2EL-X8F2-DM1SL

Specifications

■ Brass type

Type	Ø6,5		M8		M12		M18		M30					
Operating voltage	10 to 35 VDC													
Rated supply voltage	24 VDC													
Current consumption	max. 15 mA at 24 VDC													
Sensing object	Ferrous metals													
Mounting ((s)hielded, (n)on-shielded) (see note 1)	s	n	s	n	s	s	n	s	s	n	s	n		
Operating distance in mm	1,5	2,0	1,5	2,0	2,0	4,0	4,0	5,0	8,0	8,0	10,0	15,0		
Tolerance of operating distance	±10%													
Standard target size in mm (L x W x H in mm, FE 37)	6,5x6,5x1		8x8x1		12x12x1		18x18x1		24x24x1		30x30x1		45x45x1	
Differential travel	1 % ... 15 % of operating distance													
Max. response frequency in kHz	5,0		5,0		2,0	0,6	1,0	0,5	0,3	0,5	0,25	0,15		
Control output Type	E2EL-... E1 type: NPN-NO E2 type: NPN-NC F1 type: PNP-NO F2 type: PNP-NC													
Max-Load	200 mA													
Max-on-state Voltage drop	2,5 VDC (at 200mA load current and with 2 m cable)													
Circuit protection	Reverse polarity, output short-circuit													
Indicator	Operating indicator (yellow LED)													
Ambient temperature	Operating: -25° to 70°C													
Humidity	35 to 95 % RH													
Influence of temperature	± 10 % max. of Sn at 23°C in temperature range of -25° to 70°C													
Dielectric strength	1.500 VAC, 50/60 Hz for 1 min. between current carry parts and case													
Electromagnetic compatibility EMC	EN 60947-5-2													
Vibration resistance	Destruction: 10 to 70 Hz, 1,5 mm double amplitude for 1 hour each in X, Y and Z directions													
Shock resistance	Destruction: 300 m/s ² (approx. 30 G) for 6 times each in X, Y and Z directions													
Enclosure rating	IP 67 (EN 60947-1)													
Connection (see note 2)	Pre-wired	2 m PVC-cable, 3 x 0,14 mm ²				2 m PVC-cable, 3 x 0,25 mm ²				2m PVC-cable, 3 x 0,5 mm ²				
	Connector	M8 plug		M8 plug M12 plug		M12 plug								
Weight in g	Pre-wired	long	45	50	75		115		260					
		short	43	48	70		100		200					
	Connector	long	10	15	25		60		155					
		short	8	13	20		50		110					
Material	Case	Brass												
	Sensing face	PBTP												

- Note:** 1. For detailed mounting instruction please refer to page 11.
2. PUR cable and different length on request.

■ Stainless steel type

Type	Ø6,5	M8	M12	M18		
Operating voltage	10 to 35 VDC					
Rated supply voltage	24 VDC					
Current consumption	max. 15 mA at 24 VDC					
Mounting (see note 1)	Shielded					
Sensing object	Ferrous metals					
Operating distance in mm	2,0	2,0	4,0	8,0		
Tolerance of operating distance	±10%					
Standard target size (L x W x H in mm, FE 37)	6,5x6,5x1	8x8x1	12x12x1	24x24x1		
Differential travel	1 % ... 15 % of operating distance					
Max. response frequency in kHz	4,0	4,0	0,6	0,25		
Control output Type	E2EL-... E1 type: NPN-NO E2 type: NPN-NC F1 type: PNP-NO F2 type: PNP-NC					
Max-Load	200 mA					
Max-on-state Voltage drop	2,5 VDC (at 200mA load current and with 2 m cable)					
Circuit protection	Reverse polarity, output short-circuit					
Indicator	Operating indicator (yellow LED)					
Ambient temperature	Operating: -25° to 70°C					
Humidity	35 to 95 % RH					
Influence of temperature	± 10 % max. of Sn at 23°C in temperature range of -25° to 70°C					
Dielectric strength	1.500 VAC, 50/60 Hz for 1 min. between current carry parts and case					
Electromagnetic compatibility EMC	EN 60947-5-2					
Vibration resistance	Destruction: 10 to 70 Hz, 1,5 mm double amplitude for 1 hour each in X, Y and Z directions					
Shock resistance	Destruction: 300 m/s ² (approx. 30 G) for 6 times each in X, Y and Z directions					
Enclosure rating	IP 67 (EN 60947-1)					
Connection (see note 2)	Pre-wired	2 m PVC-cable, 3 x 0,14 mm ²		2 m PVC-cable, 3 x 0,25 mm ²		
	Connector	-	M8 plug	M12 plug		
Weight in g	Pre-wired	long	45	50	75	120
		short	43	48	70	105
	Connector	long	-	10	25	65
		short	-	-	20	55
Material	Case	stainless steel 1.4305 / AISI 303				
	Sensing face	PBTP				

- Note:** 1. For detailed mounting instruction please refer to page 11.
2. PUR cable and different length on request.

Engineering Data

Standardized characteristic for lateral approach

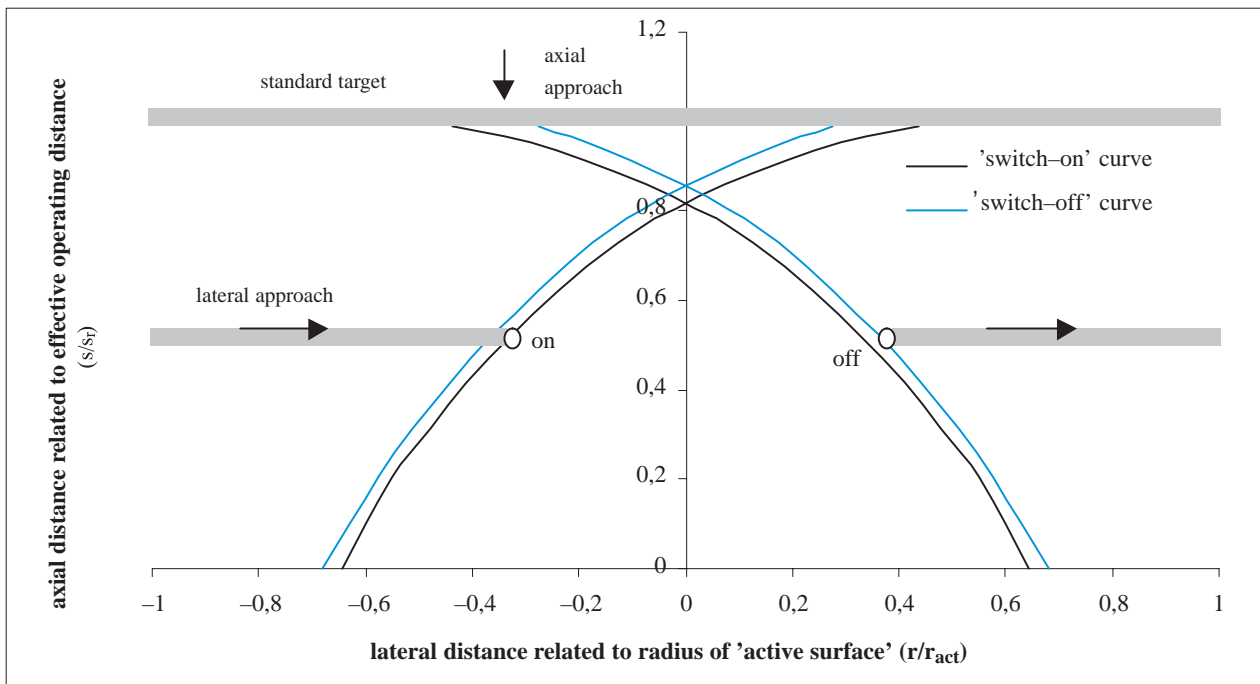

Output Circuit Diagram and Timing Chart

E2EL-X□E□
NPN Output

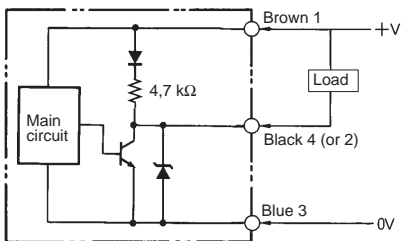

E2EL-X□F□
PNP Output

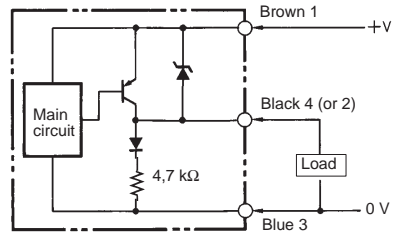

E2EL-X□E□
NPN Output

	NO	NC
Sensing object	Yes	No
Yellow indicator	Lit	Not lit
Control output	ON	OFF

E2EL-X□F□
PNP Output

	NO	NC
Sensing object	Yes	No
Yellow indicator	Lit	Not lit
Control output	ON	OFF

■ Pin Arrangement at Connector Types

1. Connector M8 (viewed to plug pins)

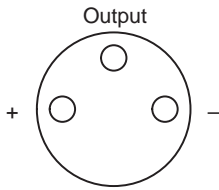

2. Connector M12 (viewed to plug pins)

NO

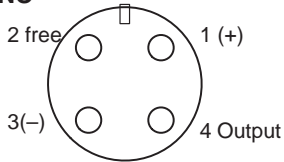

NC

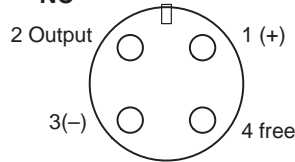

Dimensions

- Note:**
1. All units are in millimeters unless otherwise indicated.
 2. Unless otherwise specified, a tolerance of ± 0.4 mm applies to all dimensions. Values in parentheses () are cumulative values and may exceed tolerance of ± 0.4 mm.
 3. The square □ in the models represents the output configuration. Refer to *Ordering Information*.

Cable Types

E2EL-C1□R5 2M, E2EL-C2□-DS 2M

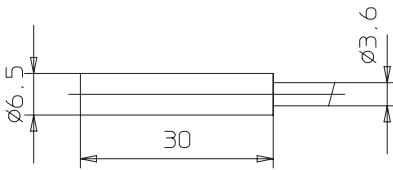

E2EL-C2M□ 2M

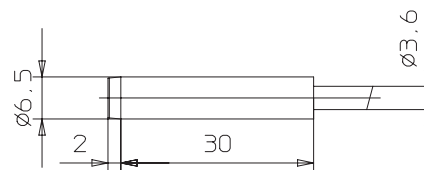

E2EL-C1R5□-L 2M, E2EL-C2□-DSL 2M

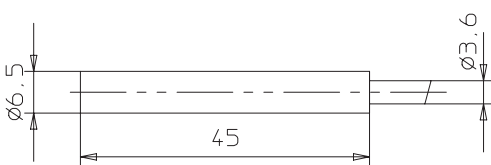

E2EL-C2M□-L 2M

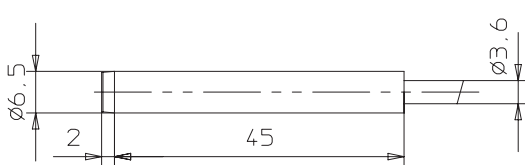

E2EL-X1R5□ 2M, E2EL-X2□-DS 2M

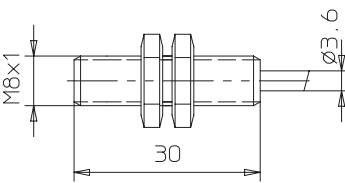

E2EL-X2M□ 2M

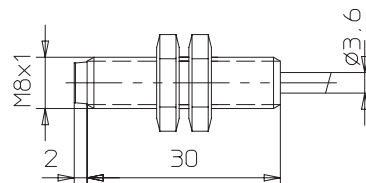

E2EL-X1R5□-L 2M, E2EL-X2□-DSL 2M

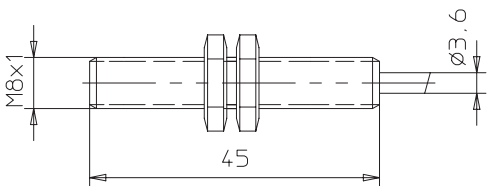

E2EL-X2M□-L 2M

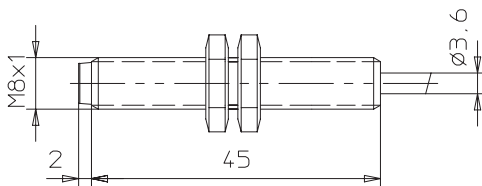

E2EL-X2□ 2M, E2EL-X4□-D 2M, E2EL-X4□-DS 2M

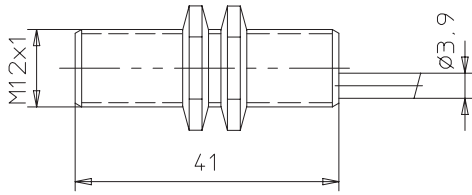

E2EL-X4M□ 2M

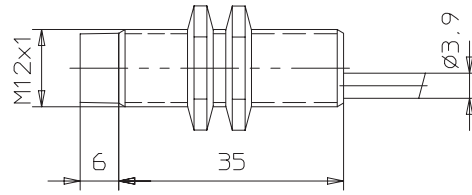

E2EL-X2□-L 2M, E2EL-X4□-DL 2M, E2EL-X4□-DSL 2M

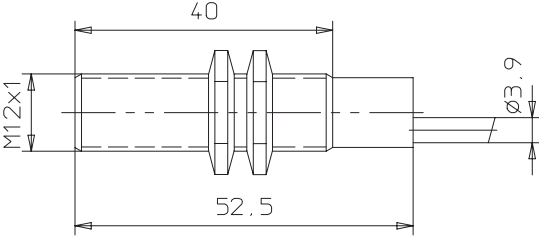

E2EL-X4M□-L 2M

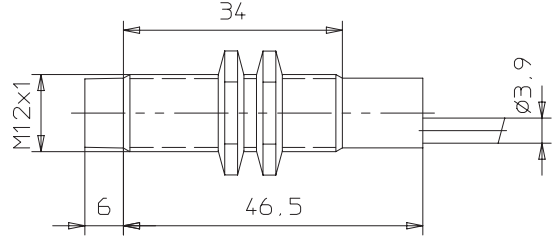

E2EL-X5□ 2M, E2EL-X8□-D 2M, E2EL-X8□-DS 2M

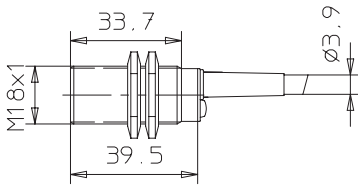

E2EL-X8M□ 2M

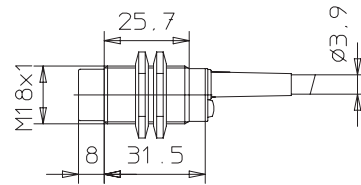

E2EL-X5□-L 2M, E2EL-X8□-DL 2M, E2EL-X8□-DSL 2M

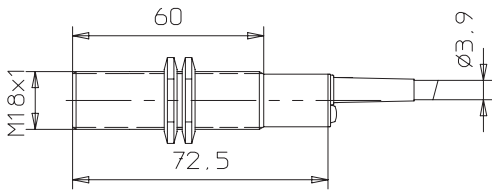

E2EL-X8M□-L 2M

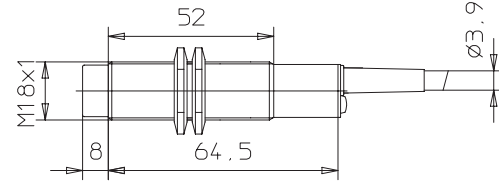

E2EL-X10□ 2M

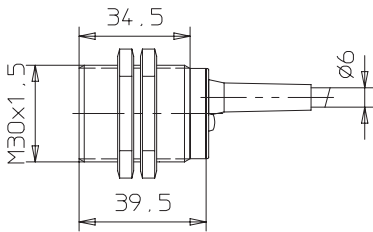

E2EL-X15M□ 2M

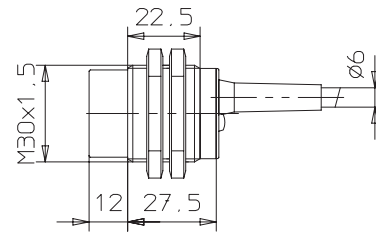

E2EL-X10□-L 2M

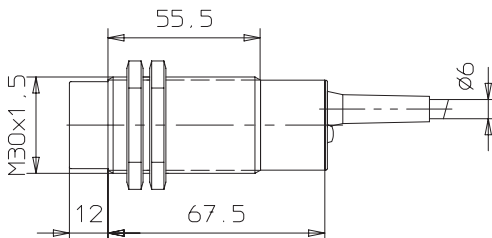

E2EL-X15M□-L 2M

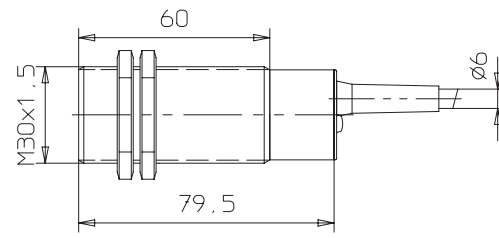

Plug Types

E2EL-C1R5□-M3

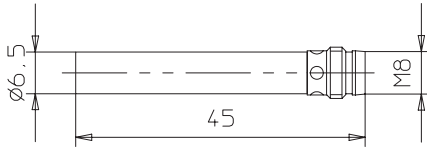

E2EL-C2M□-M3

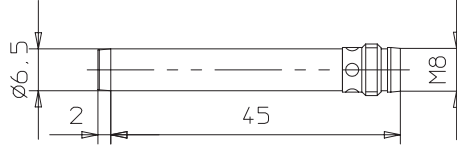

E2EL-C1R5□-M3L

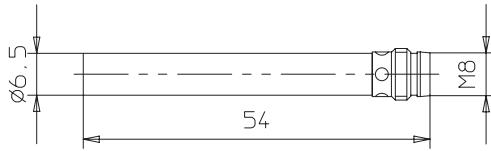

E2EL-C2M□-M3L

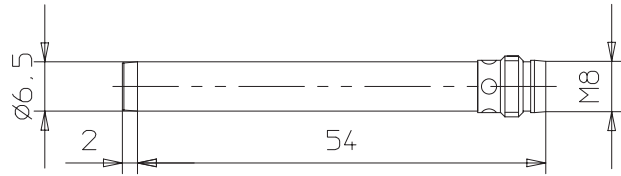

E2EL-X1R5□-M3

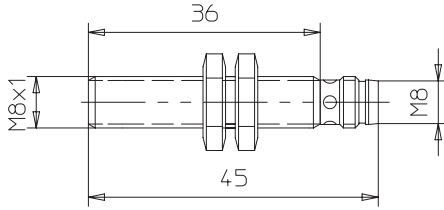

E2EL-X2M□-M3

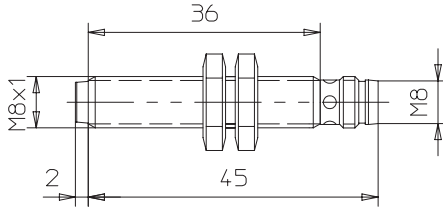

E2EL-X1R5□-M3L, E2EL-X2□DM3S

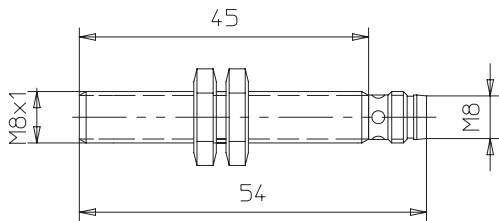

E2EL-X2M□-M3L

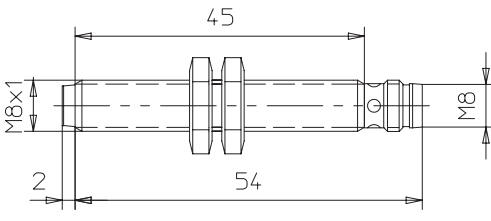

E2EL-X1R5□-M1

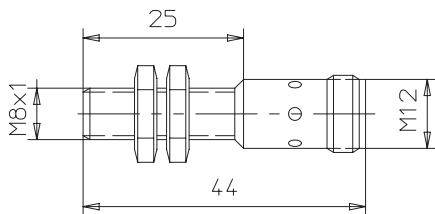

E2EL-X2M□-M1

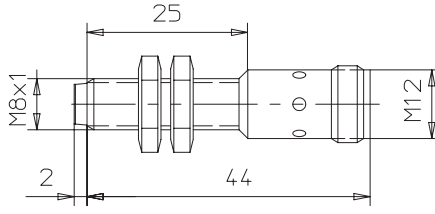

E2EL-X1R5□-M1L

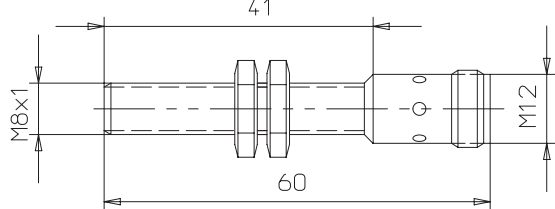

E2EL-X2M□-M1L

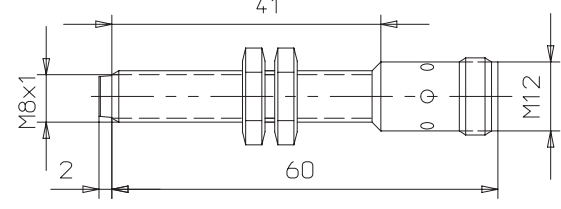

E2EL-X2□-M1, E2EL-X4□-DM1, E2EL-X4□-DM1S

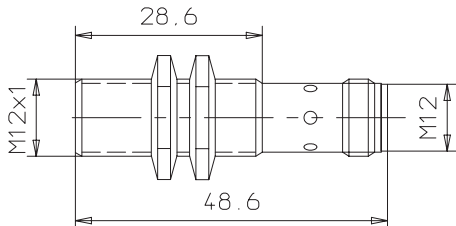

E2EL-X4M□-M1

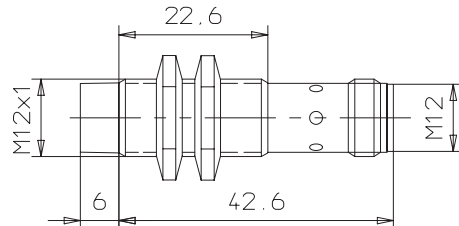

E2EL-X2□-M1L, E2EL-X4□-DM1L, E2EL-X4□-DM1SL

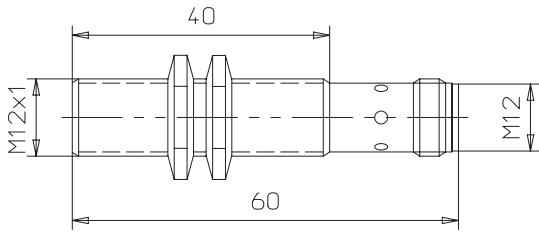

E2EL-X4M□-M1L

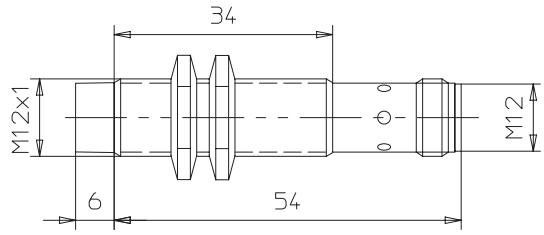

E2EL-X5□-M1, E2EL-X8□-DM1, E2EL-X8□-DM1S

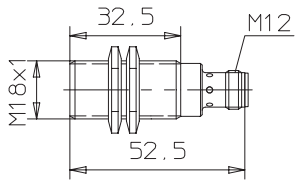

E2EL-X8M□-M1

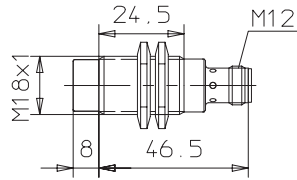

E2EL-X5□-M1L, E2EL-X8□-DM1L, E2EL-X8□-DM1SL

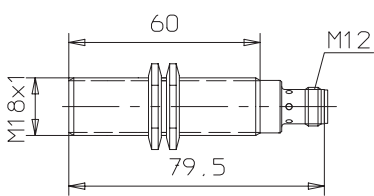

E2EL-X8M□-M1L

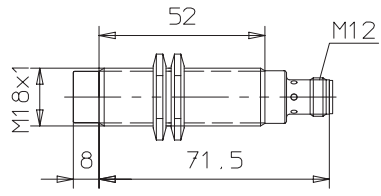

E2EL-X10□-M1

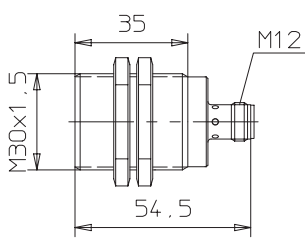

E2EL-X15M□-M1

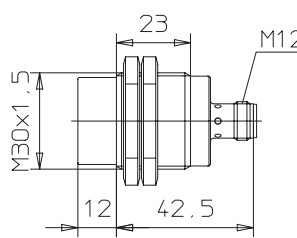

E2EL-X10□-M1L

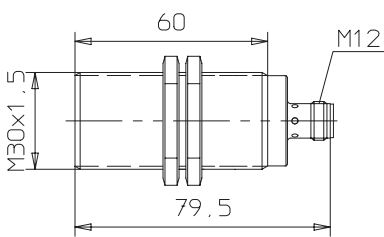

E2EL-X15M□-M1L

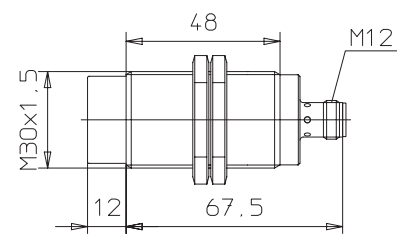

Installation

■ Caution

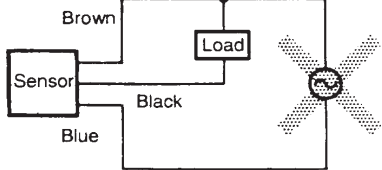
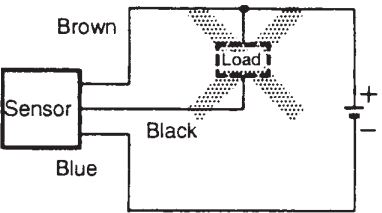
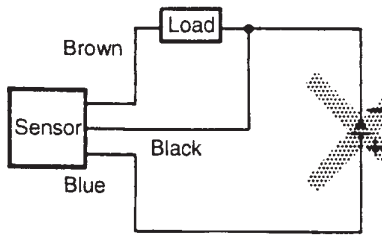
Item	Examples
<p>Power Supply</p> <p>Do not impose an excessive voltage on the E2EL, otherwise it may explode or burn.</p> <p>Do not impose 24 VAC on any E2EL model, otherwise it may explode or burn.</p>	
<p>Load short-circuit</p> <p>Do not short-circuit the load, or the E2EL may explode or burn.</p> <p>The E2EL's short-circuit protection function is valid, if the polarity of the supply voltage imposed is incorrect and within the rated voltage range.</p>	
<p>Wiring</p> <p>Be sure to wire the E2EL and load correctly, otherwise it may explode or burn.</p>	

■ Correct Use

Installation

Power Reset Time

The Proximity Sensor is ready to operate within 100 ms after power is supplied. If power supplies are connected to the Proximity Sensor and load respectively, be sure to supply power to the Proximity Sensor before supplying power to the load.

Power OFF

The Proximity Sensor may output a pulse signal when it is turned off. Therefore, it is recommended to turn off the load before turning off the Proximity Sensor.

Power Supply Transformer

When using a DC power supply, make sure that the DC power supply has an insulated transformer. Do not use a DC power supply with an auto-transformer.

Sensing Object

Metal Coating:

The sensing distance of the Proximity Sensor vary with the metal coating on sensing objects.

Wiring

High-tension Lines

Wiring through Metal Conduit

If there a power or high-tension line near the cord of the Proximity Sensor, wire the cord through an independent metal conduit to prevent against Proximity Sensor damage or malfunctioning.

Core Tractive Force

Do not pull cords with the tractive force exceeding the following:
pull force (N) = 20 x cable diameter (mm)

Mounting

The Proximity Sensor must not be subjected to excessive shock with a hammer when it is installed, otherwise the Proximity Sensor may be damaged or lose the water-resistivity.

Environment

Water-Resistivity

Do not use the Proximity Sensor underwater, outdoors or in the rain.

Operating Environment

Be sure to use the Proximity Sensor within operating ambient temperature range and do not use the Proximity Sensor outdoors so that its reliability and life expectancy can be maintained. Although the Proximity Sensor is water resistive, a cover to protect the Proximity Sensor from water or soluble machining oil is recommended so that its reliability and life expectancy can be maintained. Do not use the Proximity Sensor in an environment with chemical gas (e. G., strong alkaline or acid gases including nitric, chromic, and concentrated sulfuric acid gases).

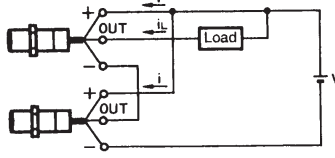
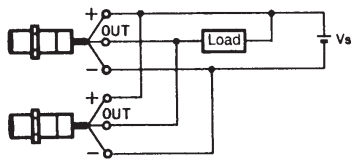
Item	Examples	Item
AND (serial connection)	<p style="text-align: center;">Correct</p> 	<p>The Sensors connected together must satisfy the following conditions:</p> $i_L + (N-1) \times i = \text{Upper-limit of control output of each Sensor}$ $V_S - N \times V_R = \text{Load operating voltage}$ <p> $N =$ No. of Sensors $V_R =$ Residual voltage of each Sensor $V_S =$ Supply voltage $i =$ Current consumption of the Sensor $i_L =$ Load current </p> <p>If the MY Relay, which operate at 24 VDC, is used as a load for example, a maximum of two Proximity Sensors can be connected to the load.</p>
OR (parallel connection)	<p style="text-align: center;">Correct</p> 	<p>The number of Sensors connected in parallel varies with the Proximity Sensor model.</p>

Effects of Surrounding Metal

Shielded types:

Shielded types allow direct installation on metal plates in an embedded manner without performance change. A minimum distance of $3s_n$ is required between the active surface and a metallic surface in front of the device. (Fig. 1).

For SUS shielded types the following minimum distances are required to avoid performance change (see Fig.2 and table below):

Shielded SUS Types	Free zone
E2EL-C2□-DS	0,5 mm
E2EL-X2□-DS	0,5 mm
E2EL-X4□-D□S	1,0 mm
E2EL-X8□-D□S	2,0 mm

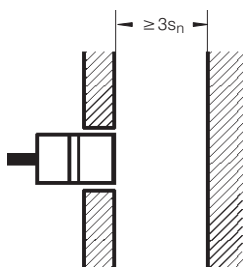

Fig.1: Shielded type (except SUS)

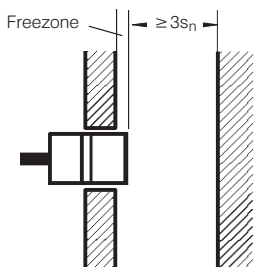

Fig.2: Shielded SUS type

Non-shielded types:

Installation of non-shielded types in metal require the minimum distances according to Fig. 3.

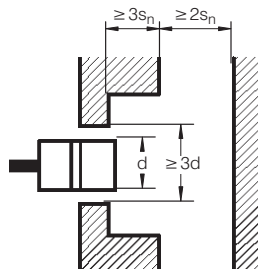

Fig.3: Non-shielded type

In the interest of product improvement, specifications are subject to change without notice.

ALL DIMENSIONS SHOWN ARE IN MILLIMETERS.

To convert millimeters into inches, multiply by 0.03937. To convert grams into ounces, multiply by 0.03527.

OMRON EUROPE B.V.
Sensor Business Unit
Carl-Benz-Straße 4
D-71154 NUFRINGEN (GERMANY)
Phone: +49-70 32-811-0
Fax: +49-70 32-811-199

Cat. No. D093-E2-1

Компания «Океан Электроники» предлагает заключение долгосрочных отношений при поставках импортных электронных компонентов на взаимовыгодных условиях!

Наши преимущества:

- Поставка оригинальных импортных электронных компонентов напрямую с производств Америки, Европы и Азии, а так же с крупнейших складов мира;
- Широкая линейка поставок активных и пассивных импортных электронных компонентов (более 30 млн. наименований);
- Поставка сложных, дефицитных, либо снятых с производства позиций;
- Оперативные сроки поставки под заказ (от 5 рабочих дней);
- Экспресс доставка в любую точку России;
- Помощь Конструкторского Отдела и консультации квалифицированных инженеров;
- Техническая поддержка проекта, помощь в подборе аналогов, поставка прототипов;
- Поставка электронных компонентов под контролем ВП;
- Система менеджмента качества сертифицирована по Международному стандарту ISO 9001;
- При необходимости вся продукция военного и аэрокосмического назначения проходит испытания и сертификацию в лаборатории (по согласованию с заказчиком);
- Поставка специализированных компонентов военного и аэрокосмического уровня качества (Xilinx, Altera, Analog Devices, Intersil, Interpoint, Microsemi, Actel, Aeroflex, Peregrine, VPT, Syfer, Eurofarad, Texas Instruments, MS Kennedy, Miteq, Cobham, E2V, MA-COM, Hittite, Mini-Circuits, General Dynamics и др.);

Компания «Океан Электроники» является официальным дистрибьютором и эксклюзивным представителем в России одного из крупнейших производителей разъемов военного и аэрокосмического назначения «JONHON», а так же официальным дистрибьютором и эксклюзивным представителем в России производителя высокотехнологичных и надежных решений для передачи СВЧ сигналов «FORSTAR».



JONHON

«JONHON» (основан в 1970 г.)

Разъемы специального, военного и аэрокосмического назначения:

(Применяются в военной, авиационной, аэрокосмической, морской, железнодорожной, горно- и нефтедобывающей отраслях промышленности)

«FORSTAR» (основан в 1998 г.)

ВЧ соединители, коаксиальные кабели,
кабельные сборки и микроволновые компоненты:

(Применяются в телекоммуникациях гражданского и специального назначения, в средствах связи, РЛС, а так же военной, авиационной и аэрокосмической отраслях промышленности).



Телефон: 8 (812) 309-75-97 (многоканальный)

Факс: 8 (812) 320-03-32

Электронная почта: ocean@oceanchips.ru

Web: <http://oceanchips.ru/>

Адрес: 198099, г. Санкт-Петербург, ул. Калинина, д. 2, корп. 4, лит. А