

## 2.0A/1.5A LDO REGULATOR

NO. EA-125-111027

### OUTLINE

The R1171x Series are CMOS-based positive voltage regulator ICs. The R1171x Series have features of low dropout voltage, high output voltage accuracy, low consumption current. Each of these ICs consists of a voltage reference unit, an error amplifier, resistor net for setting output voltage, a current limit circuit at short mode, a chip enable circuit, and thermal shutdown circuit. The output voltage of R1171 is fixed in the IC.

Low consumption current by the merit of CMOS process and built-in transistors with low ON-resistance make low dropout voltage and chip enable function prolongs the battery life. These regulators are remarkable improvement on the current regulators in terms of input transient response, and load transient response.

Thus, the R1171x Series are suitable for various power sources.

Since the packages for these ICs are high wattage HSOP-6J package, TO-252-5-P1, high density mounting of the ICs on boards is possible.

### FEATURES

- Supply Current ..... Typ. 130 $\mu$ A
- Standby Current ..... Typ. 0.1 $\mu$ A
- Output Current ..... Min. 1.5A ( $V_{IN}=V_{OUT}+1.0V$ , R1171Sxx1A/B)  
Min. 2.0A ( $V_{IN}=V_{OUT}+1.0V$ , R1171Jxx1C/D)
- Input Voltage ..... 2.1V to 6.0V
- Output Voltage ..... 1.5V to 5.0V (0.1V steps) (R1171Sxx1A/B)  
1.8V to 5.0V (0.1V steps) (R1171Jxx1C/D)  
(For other voltages, please refer to MARK INFORMATIONS.)
- Output Voltage Accuracy.....  $\pm 2.0\%$
- Dropout Voltage ..... Typ. 0.09V ( $V_{OUT}=3.0V$ ,  $I_{OUT}=300mA$ )
- Temperature-drift Coefficient of Output Voltage..... Typ.  $\pm 100ppm/^{\circ}C$
- Line Regulation ..... Typ. 0.05%/V
- Packages ..... HSOP-6J, TO-252-5-P1
- Built-in Current Limit Circuit
- Built-in Thermal Shutdown Circuit
- Ceramic capacitor for phase compensation .....  $C_{IN}=C_{OUT}=\text{Ceramic } 10\mu F$  ( $V_{OUT}<1.8V$ )  
 $C_{IN}=C_{OUT}=\text{Ceramic } 4.7\mu F$  ( $V_{OUT} \geq 1.8V$ )

### APPLICATIONS

- Local Power source for Notebook PC.
- Local Power source for portable appliances, cameras, and videos.
- Local Power source for equipment of battery-use.
- Local Power source for home appliances.

## BLOCK DIAGRAMS

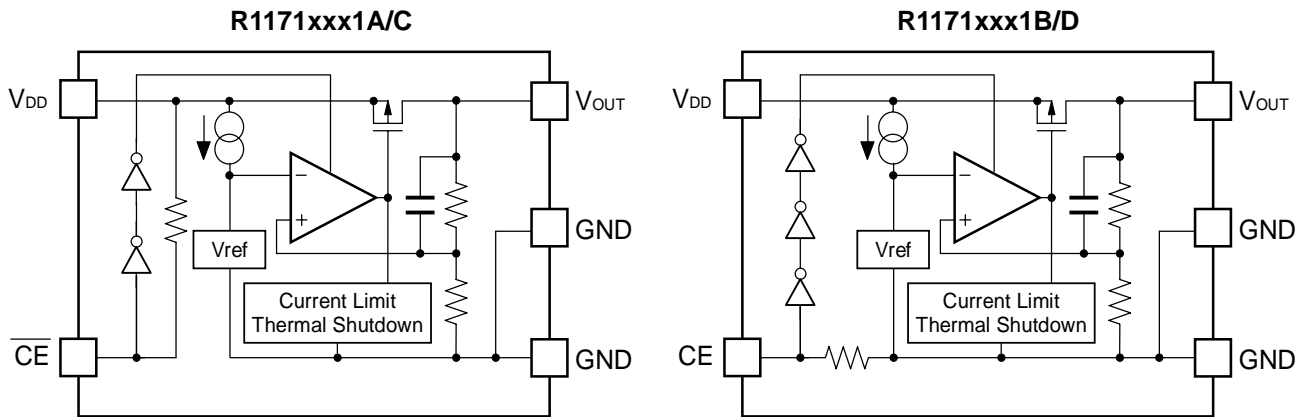

## SELECTION GUIDE

The output voltage, chip enable polarity, package for the ICs can be selected at the user's request.

Product Name	Package	Quantity per Reel	Pb Free	Halogen Free
R1171Sxx1*-E2-FE	HSOP-6J	1,000 pcs	Yes	Yes
R1171Jyy1\$-T1-F	TO-252-5-P1	3,000 pcs	Yes	No

xx: The output voltage can be designated in the range from 1.5V(15) to 5.0V(50) in 0.1V steps.  
(For other voltages, please refer to MARK INFORMATIONS.)

yy: The output voltage can be designated in the range from 1.8V(18) to 5.0V(50) in 0.1V steps.  
(For other voltages, please refer to MARK INFORMATIONS.)

\* : CE pin polarity are options as follows.

- (A) "L" active
- (B) "H" active

\$ : CE pin polarity are options as follows.

- (C) "L" active
- (D) "H" active

## PIN CONFIGURATIONS

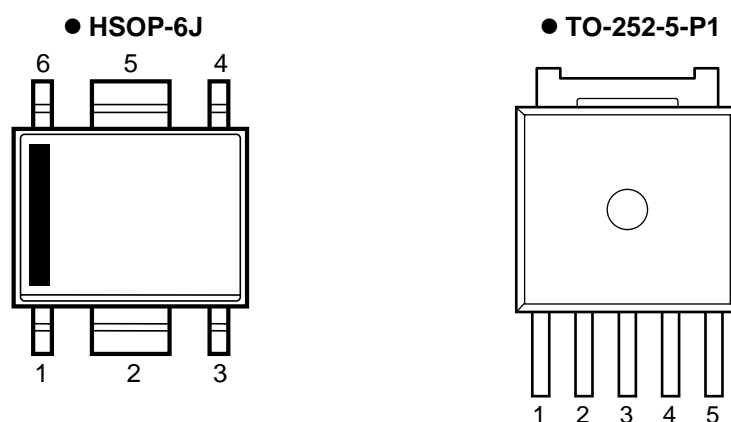

## PIN DESCRIPTIONS

### • HSOP-6J

Pin No	Symbol	Pin Description
1	$V_{OUT}$	Output Pin
2	GND	Ground Pin
3	$\overline{CE}$ or CE	Chip Enable Pin
4	NC	No Connection
5	GND	Ground Pin
6	$V_{DD}$	Input Pin

### • TO-252-5-P1

Pin No	Symbol	Pin Description
1	$V_{OUT}$	Output Pin
2	$\overline{CE}$ or CE	Chip Enable Pin
3	GND	Ground Pin
4	GND	Ground Pin
5	$V_{DD}$	Input Pin

\*) No.3 and No.4 pins must be wired short each other and connected to the GND plane when it is mounted on board.

## ABSOLUTE MAXIMUM RATINGS

Symbol	Item	Rating	Unit
$V_{IN}$	Input Voltage	7.0	V
$V_{CE}$	Input Voltage ( $\overline{CE}$ or CE Input Pin)	-0.3 to $V_{IN}+0.3$	V
$V_{OUT}$	Output Voltage	-0.3 to $V_{IN}+0.3$	V
$P_D$	Power Dissipation (HSOP-6J)* <sup>1</sup>	1700	mW
	Power Dissipation (TO-252-5-P1)* <sup>1</sup>	1900	
$T_{opt}$	Operating Temperature	-40 to 85	°C
$T_{stg}$	Storage Temperature	-55 to 125	°C

\*) For Power Dissipation, please refer to PACKAGE INFORMATION.

### ABSOLUTE MAXIMUM RATINGS

Electronic and mechanical stress momentarily exceeded absolute maximum ratings may cause the permanent damages and may degrade the life time and safety for both device and system using the device in the field.

The functional operation at or over these absolute maximum ratings is not assured.

### RECOMMENDED OPERATING CONDITIONS (ELECTRICAL CHARACTERISTICS)

All of electronic equipment should be designed that the mounted semiconductor devices operate within the recommended operating conditions. The semiconductor devices cannot operate normally over the recommended operating conditions, even if when they are used over such conditions by momentary electronic noise or surge. And the semiconductor devices may receive serious damage when they continue to operate over the recommended operating conditions.

## ELECTRICAL CHARACTERISTICS

### • R1171Sxx1A

T<sub>opt</sub>=25°C

Symbol	Item	Conditions	Min.	Typ.	Max.	Unit
V <sub>OUT</sub>	Output Voltage	V <sub>IN</sub> -V <sub>OUT</sub> =1.0V, I <sub>OUT</sub> =200mA	×0.98		×1.02	V
$\frac{\Delta V_{OUT}}{\Delta I_{OUT}}$	Load Regulation	V <sub>IN</sub> -V <sub>OUT</sub> =1.0V 1mA ≤ I <sub>OUT</sub> ≤ 300mA		10	60	mV
V <sub>DIF</sub>	Dropout Voltage	I <sub>OUT</sub> =300mA		0.16	0.35	V
				0.14	0.32	
				0.13	0.28	
				0.12	0.24	
				0.10	0.21	
				0.09	0.18	
I <sub>SS</sub>	Supply Current	V <sub>IN</sub> -V <sub>OUT</sub> =1.0V, V <sub>CE</sub> =0V		130	320	μA
I <sub>standby</sub>	Standby Current	V <sub>IN</sub> -V <sub>OUT</sub> =1.0V, V <sub>IN</sub> =V <sub>CE</sub>		0.1	2.0	μA
$\frac{\Delta V_{OUT}}{\Delta V_{IN}}$	Line Regulation	I <sub>OUT</sub> =200mA	Refer to the following table			
RR	Ripple Rejection	f=1kHz, Ripple 0.5Vp-p				
V <sub>IN</sub>	Input Voltage		2.1		6.0	V
$\frac{\Delta V_{OUT}}{\Delta T_{opt}}$	Output Voltage Temperature Coefficient	I <sub>OUT</sub> =10mA -40°C ≤ T <sub>opt</sub> ≤ 85°C		±100		ppm/°C
I <sub>LIM</sub>	Output Current	V <sub>IN</sub> -V <sub>OUT</sub> =1.0V	1.5			A
I <sub>SC</sub>	Short Current Limit	V <sub>OUT</sub> =0V		200		mA
R <sub>PU</sub>	Pull-up resistance for $\overline{CE}$ pin		2.5	5.0	10.0	MΩ
V <sub>CEH</sub>	$\overline{CE}$ Input Voltage "H"		1.2		V <sub>IN</sub>	V
V <sub>CEL</sub>	$\overline{CE}$ Input Voltage "L"		0		0.25	V
T <sub>TSD</sub>	Thermal Shutdown Detector Threshold Temperature	Junction Temperature		150		°C
T <sub>TSR</sub>	Thermal Shutdown Released Temperature	Junction Temperature		120		°C

### • Line Regulation by Output Voltage

T<sub>opt</sub>=25°C

Output Voltage V <sub>OUT</sub> (V)	Line Regulation $\Delta V_{OUT}/\Delta V_{IN}$ (%/V)		
	Condition	Typ.	Max.
1.5 ≤ V <sub>OUT</sub> < 1.6	I <sub>OUT</sub> =200mA, 2.1V ≤ V <sub>IN</sub> ≤ 6.0V	0.05	0.30
1.6 ≤ V <sub>OUT</sub> ≤ 5.0			

### • Ripple Rejection by Output Voltage

T<sub>opt</sub>=25°C

Output Voltage V <sub>OUT</sub> (V)	Ripple Rejection RR (dB)	
	Condition	Typ.
1.5 ≤ V <sub>OUT</sub> < 4.7	f=1kHz, Ripple 0.5Vp-p, V <sub>IN</sub> -V <sub>OUT</sub> =1.0V	50
4.7 ≤ V <sub>OUT</sub> ≤ 5.0		

## R1171x

### • R1171Sxx1B

T<sub>opt</sub>=25°C

Symbol	Item	Conditions	Min.	Typ.	Max.	Unit	
V <sub>OUT</sub>	Reference Voltage for Adjustable Voltage Regulator	V <sub>IN</sub> -V <sub>OUT</sub> =1.0V I <sub>OUT</sub> =200mA	×0.98		×1.02	V	
ΔV <sub>OUT</sub> /ΔI <sub>OUT</sub>	Load Regulation	V <sub>IN</sub> -V <sub>OUT</sub> =1.0V 1mA ≤ I <sub>OUT</sub> ≤ 300mA		10	60	mV	
V <sub>DIF</sub>	Dropout Voltage	I <sub>OUT</sub> =300mA		0.16	0.35	V	
			1.5 ≤ V <sub>OUT</sub> <1.6		0.14		0.32
			1.6 ≤ V <sub>OUT</sub> <1.7		0.13		0.28
			1.7 ≤ V <sub>OUT</sub> <1.8		0.12		0.24
			1.8 ≤ V <sub>OUT</sub> <2.0		0.10		0.21
			2.0 ≤ V <sub>OUT</sub> <2.5		0.09		0.18
I <sub>SS</sub>	Supply Current	V <sub>IN</sub> -V <sub>OUT</sub> =1.0V, V <sub>CE</sub> =V <sub>IN</sub>		130	320	μA	
I <sub>standby</sub>	Standby Current	V <sub>IN</sub> -V <sub>OUT</sub> =1.0V, V <sub>CE</sub> =0V		0.1	2.0	μA	
ΔV <sub>OUT</sub> /ΔV <sub>IN</sub>	Line Regulation	I <sub>OUT</sub> =200mA	Refer to the following table				
RR	Ripple Rejection	f=1kHz, Ripple 0.5Vp-p					
V <sub>IN</sub>	Input Voltage		2.1		6.0	V	
ΔV <sub>OUT</sub> /ΔT <sub>opt</sub>	Output Voltage Temperature Coefficient	I <sub>OUT</sub> =10mA -40°C ≤ T <sub>opt</sub> ≤ 85°C		±100		ppm/°C	
I <sub>LIM</sub>	Output Current	V <sub>IN</sub> -V <sub>OUT</sub> =1.0V	1.5			A	
I <sub>SC</sub>	Short Current Limit	V <sub>OUT</sub> =0V		200		mA	
R <sub>PD</sub>	Pull-down resistance for CE pin		2.5	5.0	10.0	MΩ	
V <sub>CEH</sub>	CE Input Voltage "H"		1.2		V <sub>IN</sub>	V	
V <sub>CEL</sub>	CE Input Voltage "L"		0		0.25	V	
T <sub>TSD</sub>	Thermal Shutdown Detector Threshold Temperature	Junction Temperature		150		°C	
T <sub>TSR</sub>	Thermal Shutdown Released Temperature	Junction Temperature		120		°C	

### • Line Regulation by Output Voltage

T<sub>opt</sub>=25°C

Output Voltage V <sub>OUT</sub> (V)	Line Regulation ΔV <sub>OUT</sub> /ΔV <sub>IN</sub> (%/V)		
	Condition	Typ.	Max.
1.5 ≤ V <sub>OUT</sub> < 1.6	I <sub>OUT</sub> =200mA, 2.1V ≤ V <sub>IN</sub> ≤ 6.0V	0.05	0.30
1.6 ≤ V <sub>OUT</sub> ≤ 5.0			

### • Ripple Rejection by Output Voltage

T<sub>opt</sub>=25°C

Output Voltage V <sub>OUT</sub> (V)	Ripple Rejection RR (dB)	
	Condition	Typ.
1.5 ≤ V <sub>OUT</sub> < 4.7	f=1kHz, Ripple 0.5Vp-p, V <sub>IN</sub> -V <sub>OUT</sub> =1.0V	50
4.7 ≤ V <sub>OUT</sub> ≤ 5.0		

- R1171Jxx1C

T<sub>opt</sub>=25°C

Symbol	Item	Conditions	Min.	Typ.	Max.	Unit
V <sub>OUT</sub>	Output Voltage	V <sub>IN</sub> -V <sub>OUT</sub> =1.0V I <sub>OUT</sub> =200mA	×0.98		×1.02	V
ΔV <sub>OUT</sub> / ΔI <sub>OUT</sub>	Load Regulation	V <sub>IN</sub> -V <sub>OUT</sub> =1.0V 1mA ≤ I <sub>OUT</sub> ≤ 300mA		10	60	mV
V <sub>DIF</sub>	Dropout Voltage	I <sub>OUT</sub> =300mA	1.8 ≤ V <sub>OUT</sub> <2.0	0.12	0.24	V
			2.0 ≤ V <sub>OUT</sub> <2.5	0.10	0.21	
			2.5 ≤ V <sub>OUT</sub> ≤ 5.0	0.09	0.18	
I <sub>SS</sub>	Supply Current	V <sub>IN</sub> -V <sub>OUT</sub> =1.0V, V <sub>CE</sub> =0V		130	320	μA
I <sub>standby</sub>	Standby Current	V <sub>IN</sub> -V <sub>OUT</sub> =1.0V, V <sub>IN</sub> =V <sub>CE</sub>		0.1	2.0	μA
ΔV <sub>OUT</sub> / ΔV <sub>IN</sub>	Line Regulation	I <sub>OUT</sub> =200mA V <sub>OUT</sub> +0.5V ≤ V <sub>IN</sub> ≤ 6V		0.05	0.30	%/V
RR	Ripple Rejection	f=1kHz, Ripple 0.5Vp-p	Refer to the following table			
V <sub>IN</sub>	Input Voltage		2.1		6.0	V
ΔV <sub>OUT</sub> / ΔT <sub>opt</sub>	Output Voltage Temperature Coefficient	I <sub>OUT</sub> =10mA -40°C ≤ T <sub>opt</sub> ≤ 85°C		±100		ppm/°C
I <sub>LIM</sub>	Output Current	V <sub>IN</sub> -V <sub>OUT</sub> =1.0V	2.0			A
I <sub>SC</sub>	Short Current Limit	V <sub>OUT</sub> =0V		200		mA
R <sub>PU</sub>	Pull-up resistance for $\overline{CE}$ pin		2.5	5.0	10.0	MΩ
V <sub>CEH</sub>	$\overline{CE}$ Input Voltage "H"		1.2		V <sub>IN</sub>	V
V <sub>CEL</sub>	$\overline{CE}$ Input Voltage "L"		0		0.25	V
T <sub>TSD</sub>	Thermal Shutdown Detector Threshold Temperature	Junction Temperature		150		°C
T <sub>TSR</sub>	Thermal Shutdown Released Temperature	Junction Temperature		120		°C

- Ripple Rejection by Output Voltage

T<sub>opt</sub>=25°C

Output Voltage V <sub>OUT</sub> (V)	Ripple Rejection RR (dB)	
	Condition	Typ.
1.8 ≤ V <sub>OUT</sub> < 4.7	f=1kHz, Ripple 0.5Vp-p, V <sub>IN</sub> -V <sub>OUT</sub> =1.0V	50
4.7 ≤ V <sub>OUT</sub> ≤ 5.0	f=1kHz, Ripple 0.5Vp-p, V <sub>IN</sub> =5.75V	

## R1171x

### • R1171Jxx1D

T<sub>opt</sub>=25°C

Symbol	Item	Conditions	Min.	Typ.	Max.	Unit
V <sub>OUT</sub>	Reference Voltage for Adjustable Voltage Regulator	V <sub>IN</sub> -V <sub>OUT</sub> =1.0V I <sub>OUT</sub> =200mA	×0.98		×1.02	V
ΔV <sub>OUT</sub> / ΔI <sub>OUT</sub>	Load Regulation	V <sub>IN</sub> -V <sub>OUT</sub> =1.0V 1mA ≤ I <sub>OUT</sub> ≤ 300mA		10	60	mV
V <sub>DIF</sub>	Dropout Voltage	I <sub>OUT</sub> =300mA	1.8 ≤ V <sub>OUT</sub> <2.0	0.12	0.24	V
			2.0 ≤ V <sub>OUT</sub> <2.5	0.10	0.21	
			2.5 ≤ V <sub>OUT</sub> ≤ 5.0	0.09	0.18	
I <sub>SS</sub>	Supply Current	V <sub>IN</sub> -V <sub>OUT</sub> =1.0V, V <sub>CE</sub> =V <sub>IN</sub>		130	320	μA
I <sub>standby</sub>	Standby Current	V <sub>IN</sub> -V <sub>OUT</sub> =1.0V, V <sub>CE</sub> =0V		0.1	2.0	μA
ΔV <sub>OUT</sub> / ΔV <sub>IN</sub>	Line Regulation	I <sub>OUT</sub> =200mA V <sub>OUT</sub> +0.5V ≤ V <sub>IN</sub> ≤ 6V		0.05	0.30	%/V
RR	Ripple Rejection	f=1kHz, Ripple 0.5Vp-p	Refer to the following table			
V <sub>IN</sub>	Input Voltage		2.1		6.0	V
ΔV <sub>OUT</sub> / ΔT <sub>opt</sub>	Output Voltage Temperature Coefficient	I <sub>OUT</sub> =10mA -40°C ≤ T <sub>opt</sub> ≤ 85°C		±100		ppm/°C
I <sub>LIM</sub>	Output Current	V <sub>IN</sub> -V <sub>OUT</sub> =1.0V	2.0			A
I <sub>SC</sub>	Short Current Limit	V <sub>OUT</sub> =0V		200		mA
R <sub>PD</sub>	Pull-down resistance for CE pin		2.5	5.0	10.0	MΩ
V <sub>CEH</sub>	CE Input Voltage "H"		1.2		V <sub>IN</sub>	V
V <sub>CEL</sub>	CE Input Voltage "L"		0		0.25	V
T <sub>TSD</sub>	Thermal Shutdown Detector Threshold Temperature	Junction Temperature		150		°C
T <sub>TSR</sub>	Thermal Shutdown Released Temperature	Junction Temperature		120		°C

### • Ripple Rejection by Output Voltage

T<sub>opt</sub>=25°C

Output Voltage V <sub>OUT</sub> (V)	Ripple Rejection RR (dB)	
	Condition	Typ.
1.8 ≤ V <sub>OUT</sub> < 4.7	f=1kHz, Ripple 0.5Vp-p, V <sub>IN</sub> -V <sub>OUT</sub> =1.0V	50
4.7 ≤ V <sub>OUT</sub> ≤ 5.0	f=1kHz, Ripple 0.5Vp-p, V <sub>IN</sub> =5.75V	



## TEST CIRCUITS

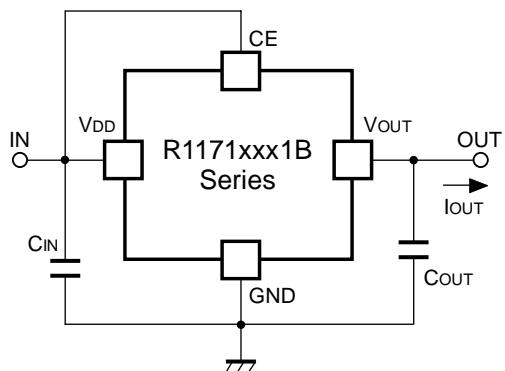

**Standard Test Circuit**

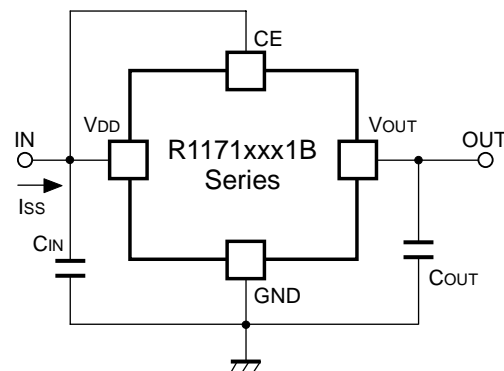

**Supply Current Test Circuit**

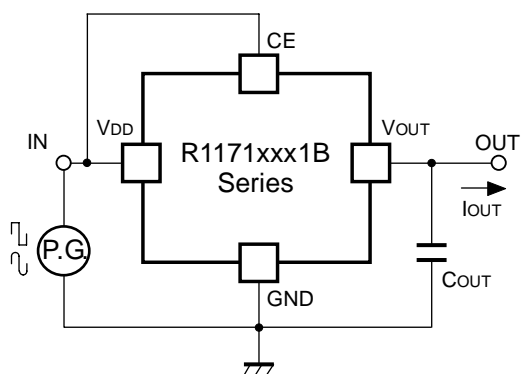

**Test Circuit for Ripple Rejection,  
Input Transient Response**

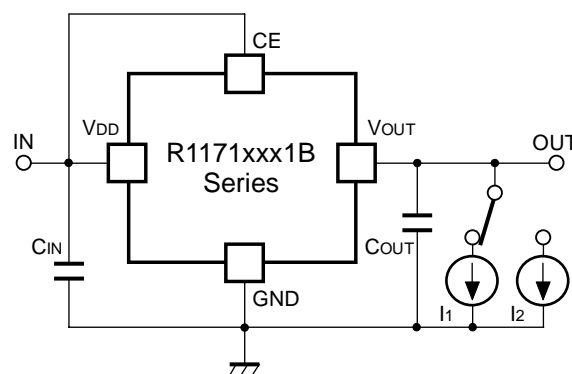

**Test Circuit for Load Transient Response**

## TYPICAL CHARACTERISTICS

### 1) Output Voltage vs. Output Current (Topt=25°C)

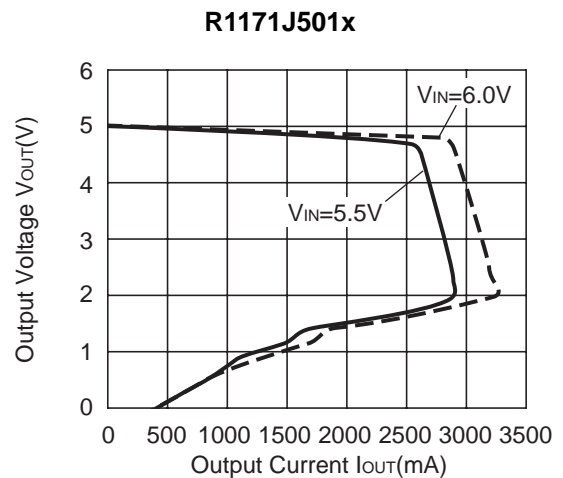
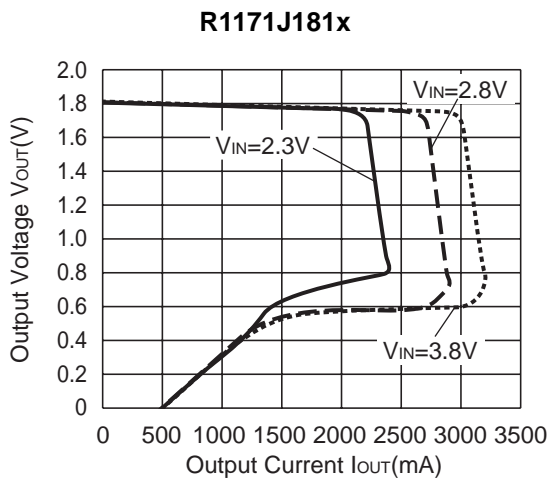
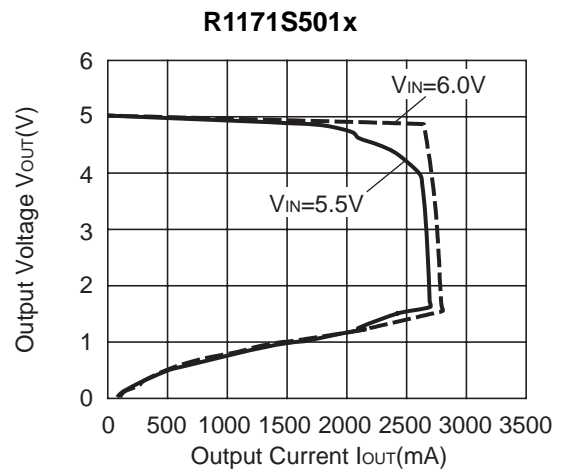
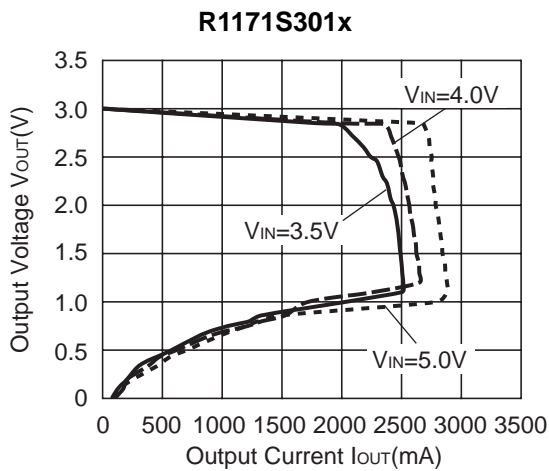
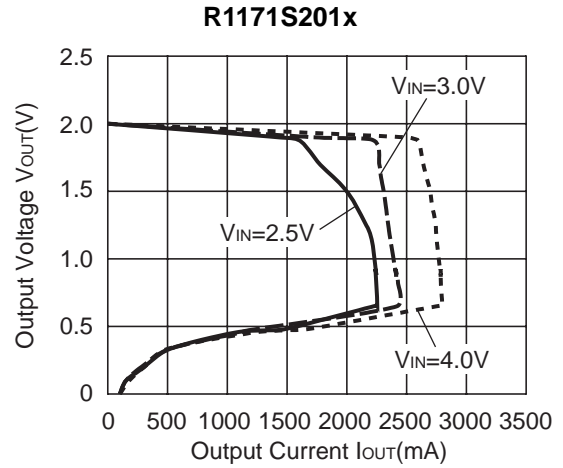
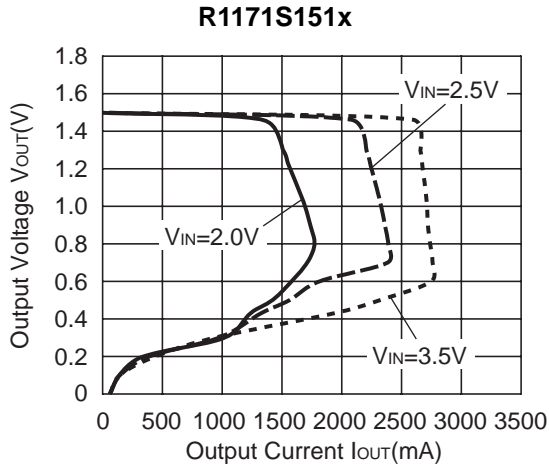

2) Output Voltage vs. Input Voltage ( $T_{opt}=25^{\circ}\text{C}$ )

R1171x151B

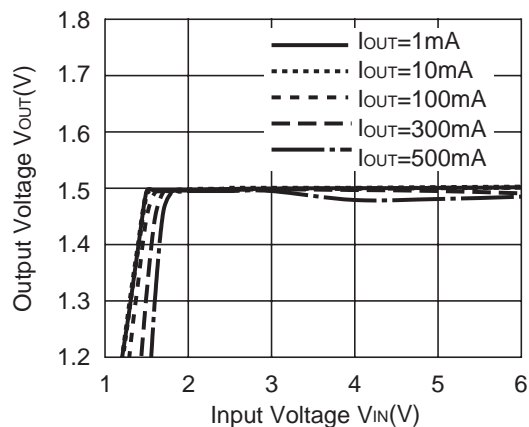

R1171x201B

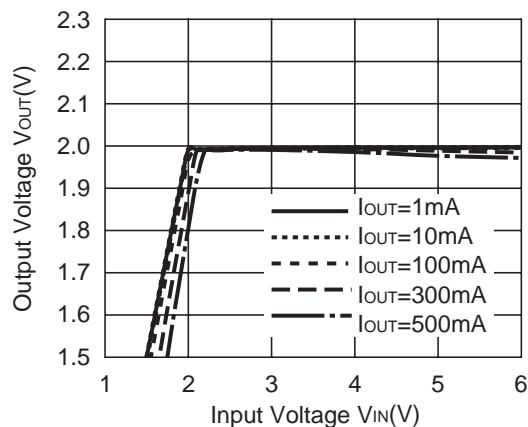

R1171x301B

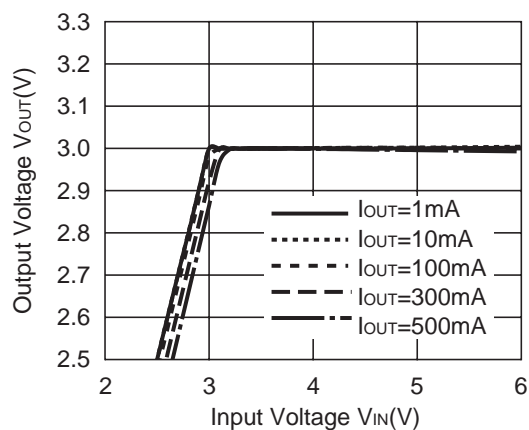

R1171x501B

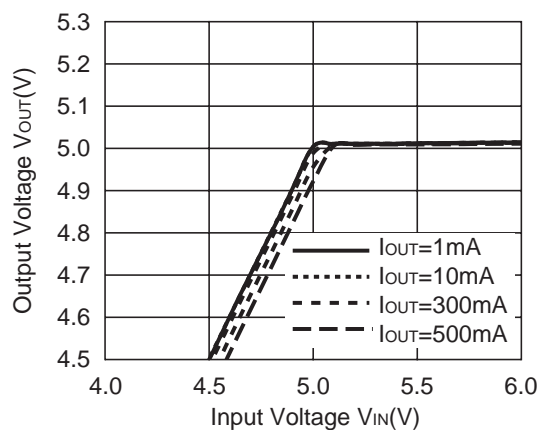

## 3) Dropout Voltage vs. Output Current

R1171S151x

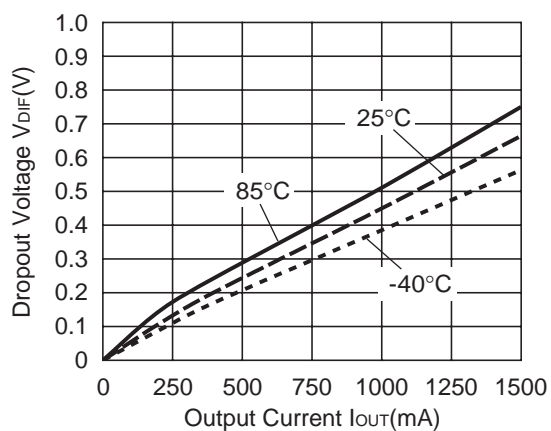

R1171S201x

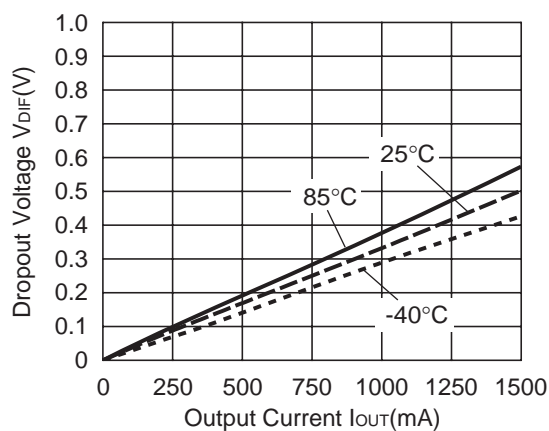

R1171S301x

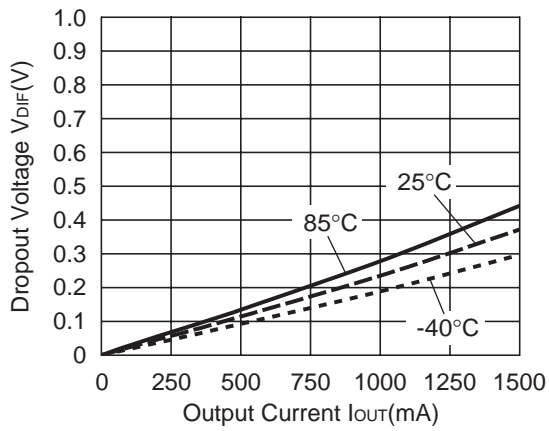

R1171S501x

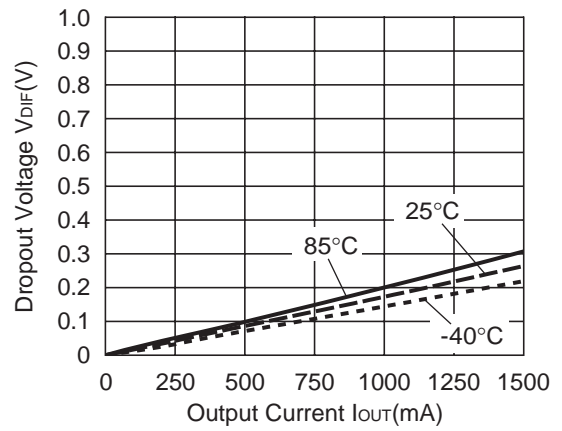

R1171J181x

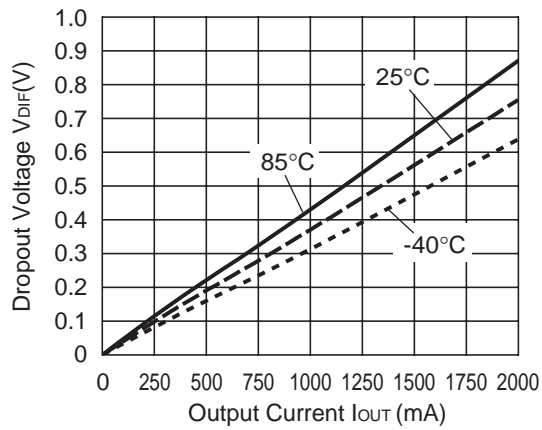

R1171J201x

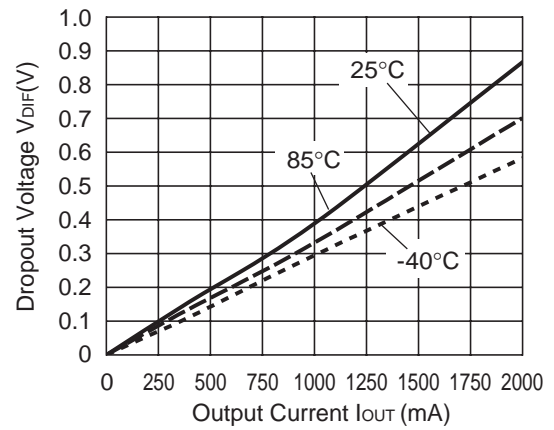

R1171J301x

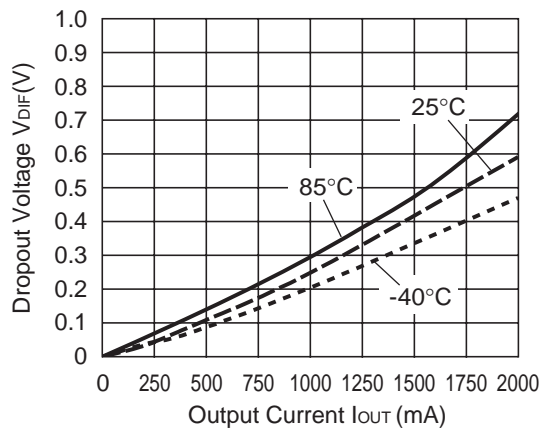

R1171J501x

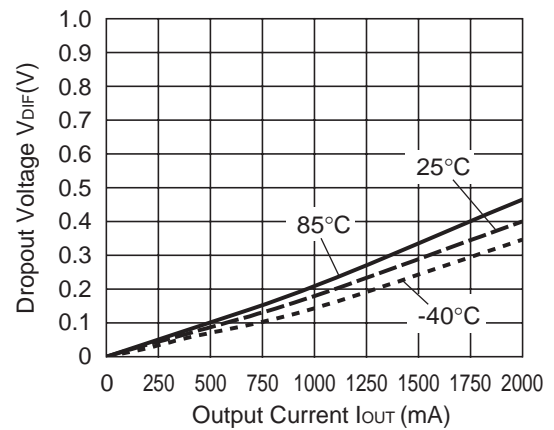

## 4) Output Voltage vs. Temperature

R1171x151B

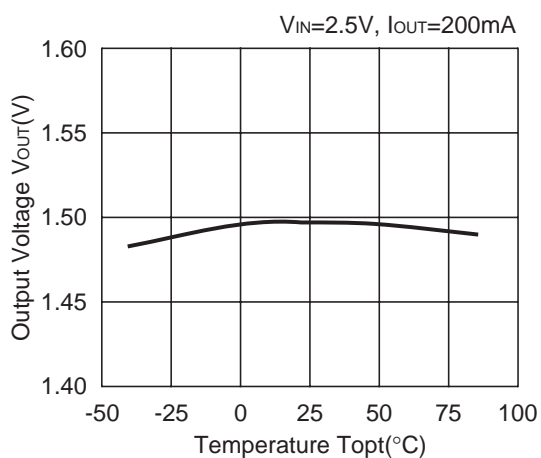

R1171x201B

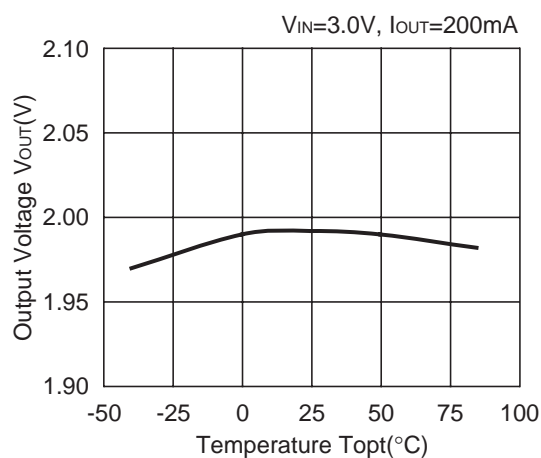

R1171x301B

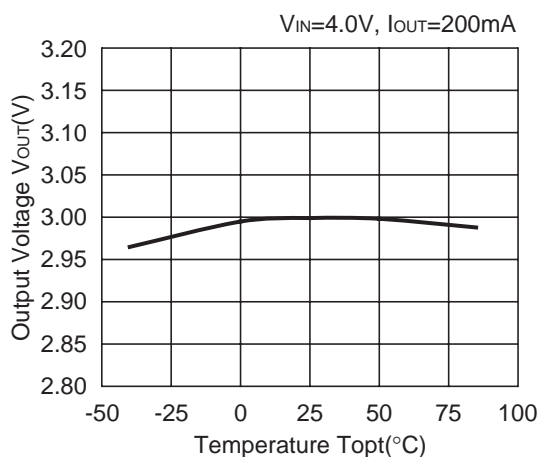

R1171x501B

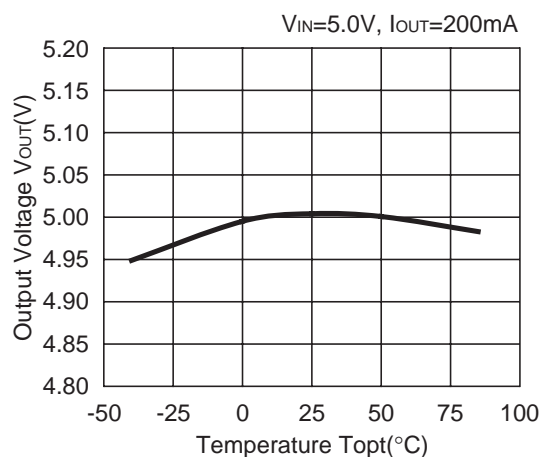
5) Supply Current vs. Input Voltage ( $T_{opt}=25^{\circ}C$ )

R1171x151B

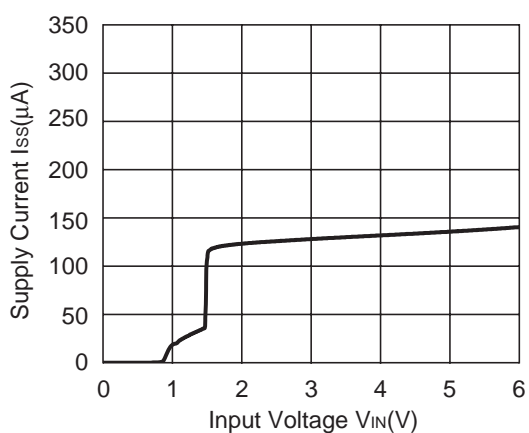

R1171x201B

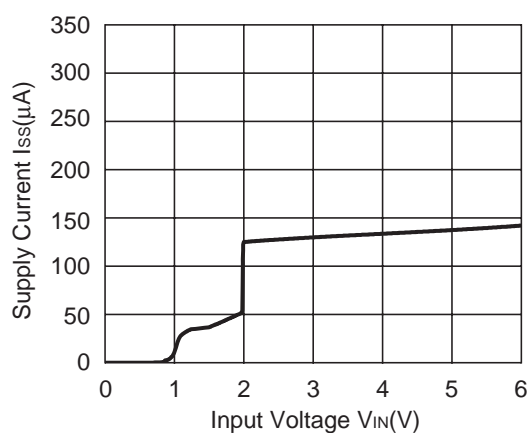

R1171x301B

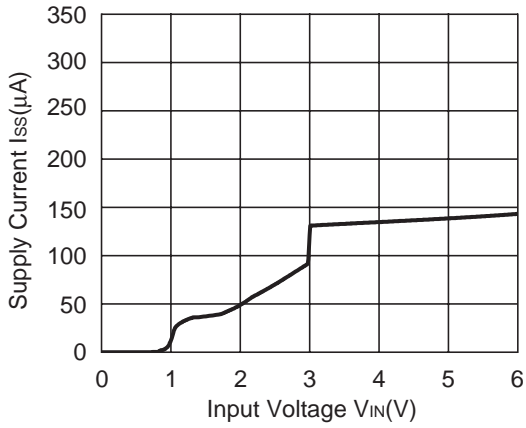

R1171x501B

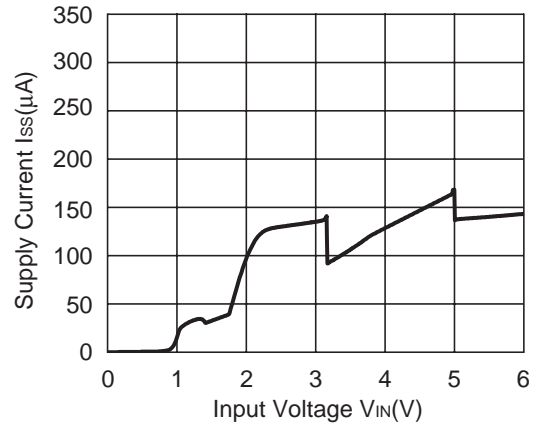

6) Supply Current vs. Temperature

R1171x151B

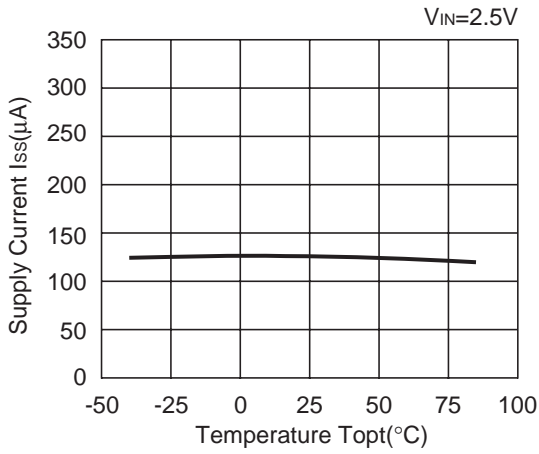

R1171x201B

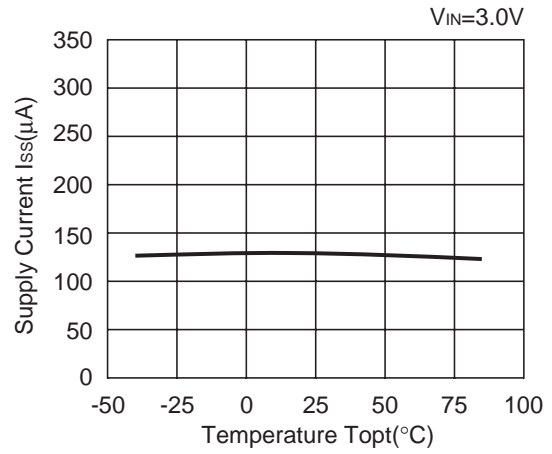

R1171x301B

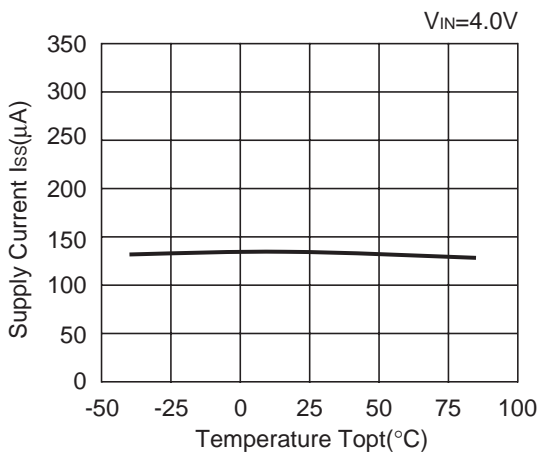

R1171x501B

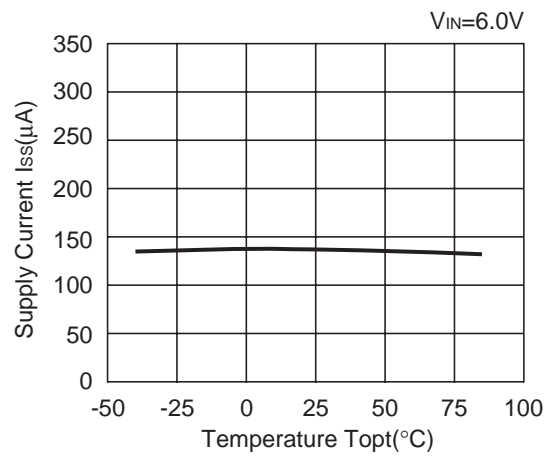

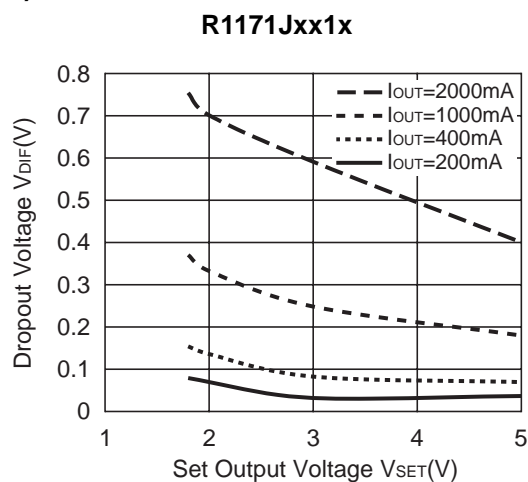
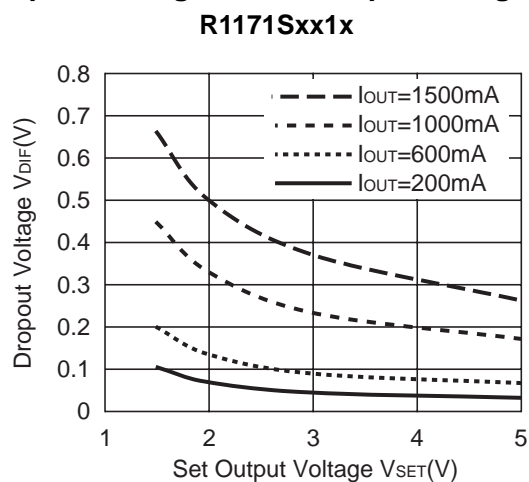
7) Dropout Voltage vs. Set Output Voltage ( $T_{opt}=25^{\circ}\text{C}$ )

## 8) Ripple Rejection vs. Frequency

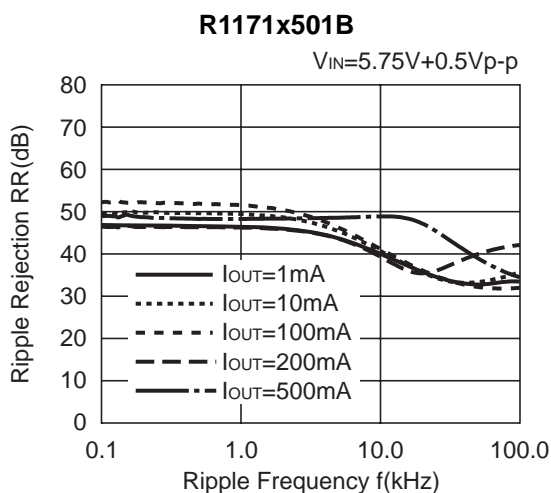
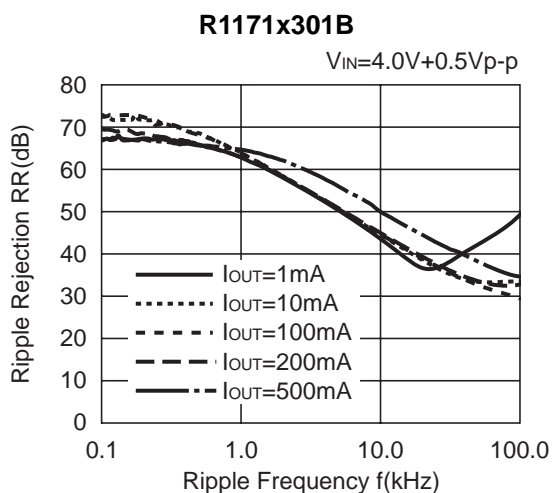
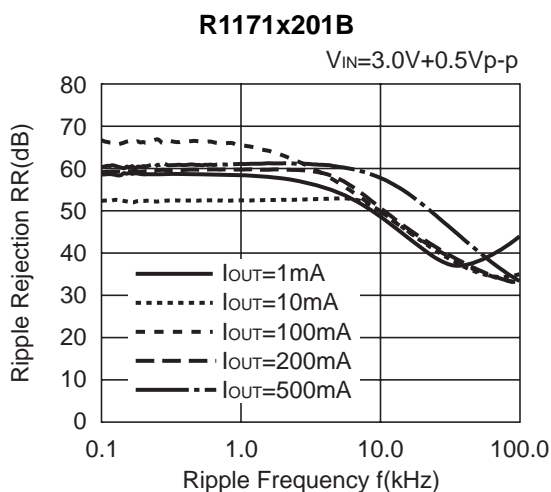
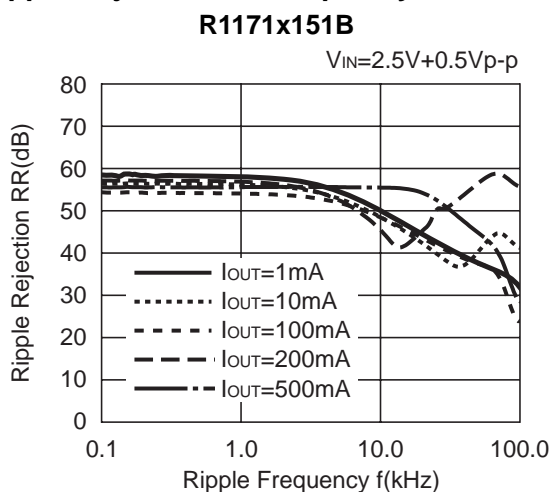

9) Ripple Rejection vs. Input Voltage

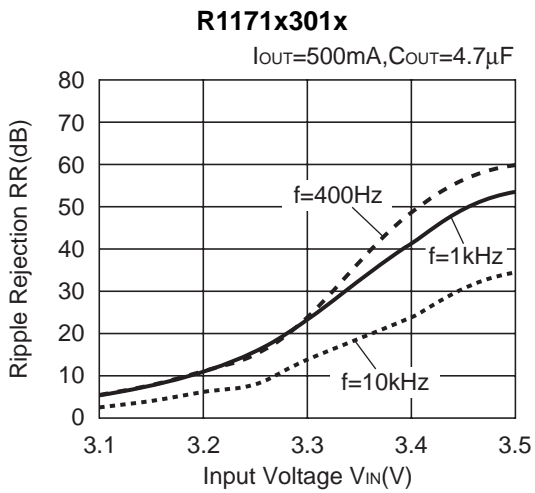
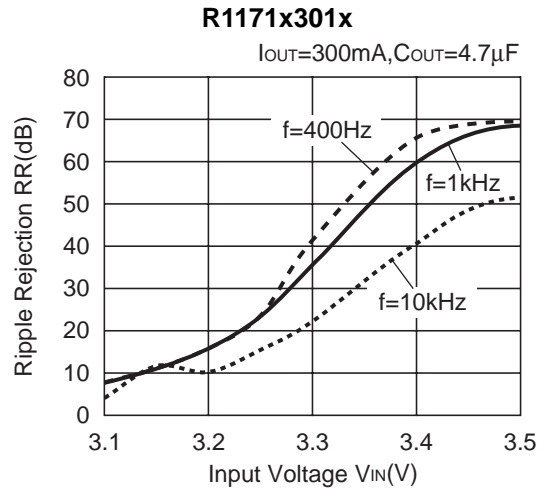
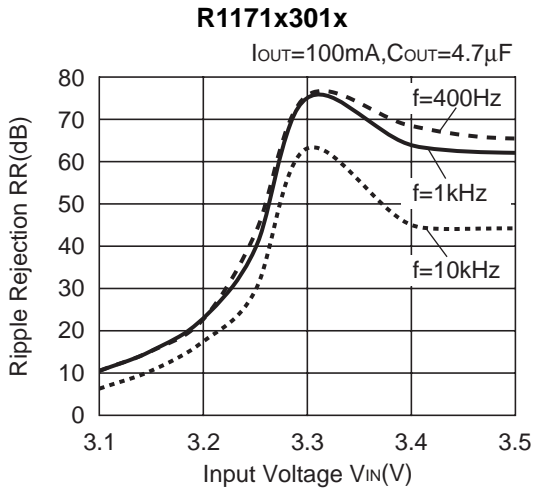
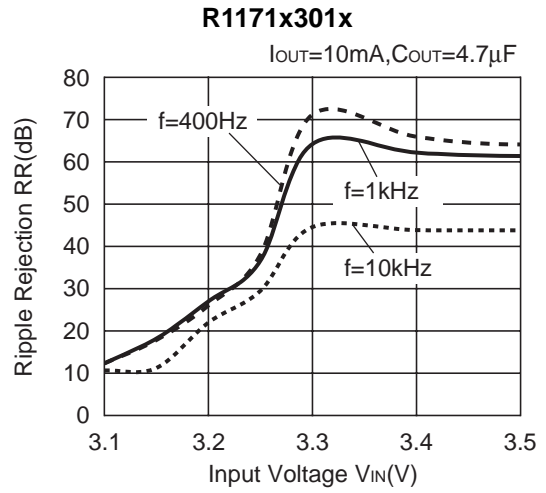
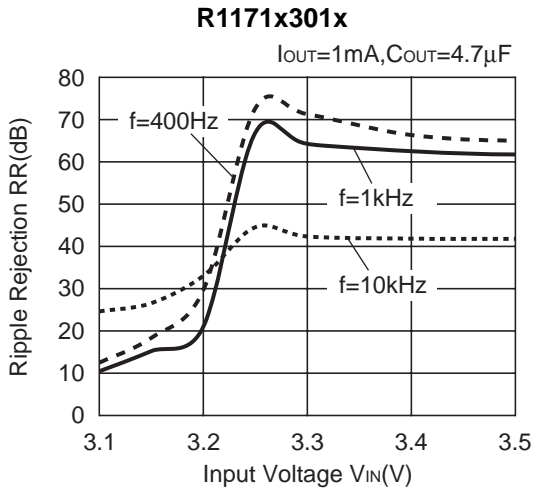



10) Input Transient Response (T<sub>opt</sub>=25°C)

## R1171x151B

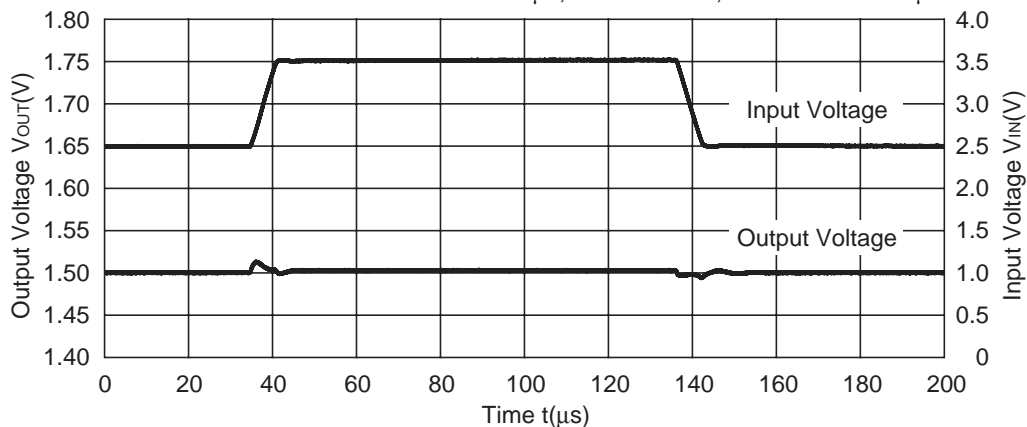
tr=tf=5μs, I<sub>OUT</sub>=1000mA, C<sub>OUT</sub>=Ceramic 10μF

## R1171x201B

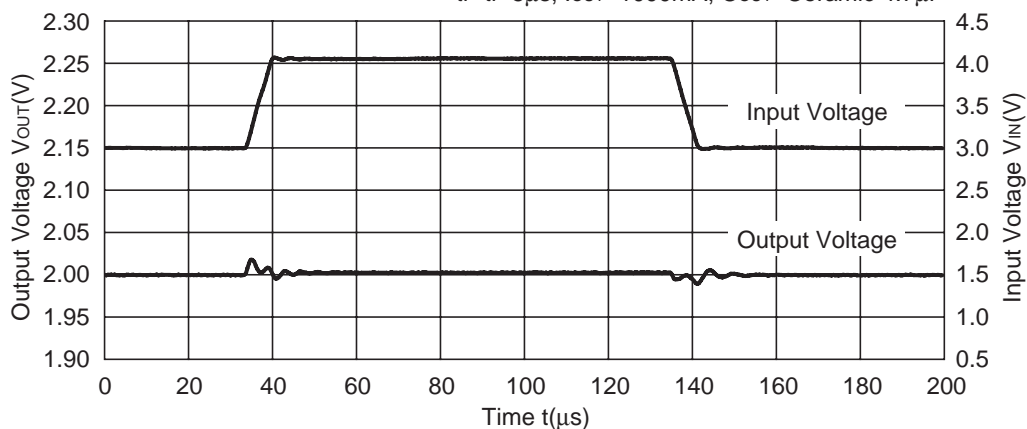
tr=tf=5μs, I<sub>OUT</sub>=1000mA, C<sub>OUT</sub>=Ceramic 4.7μF

## R1171x301B

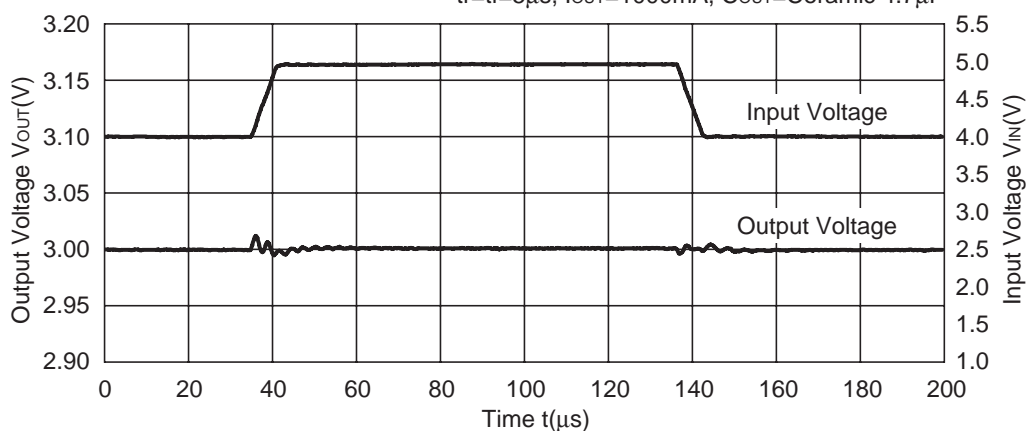
tr=tf=5μs, I<sub>OUT</sub>=1000mA, C<sub>OUT</sub>=Ceramic 4.7μF

**R1171x501B**

$t_r=t_f=5\mu s$ ,  $I_{OUT}=1000mA$ ,  $C_{OUT}=\text{Ceramic } 4.7\mu F$

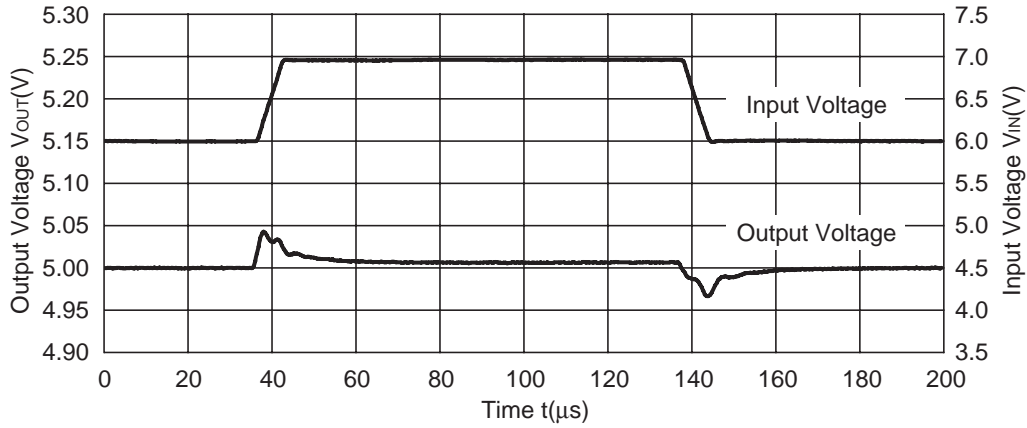

**11) Load Transient Response ( $T_{opt}=25^{\circ}C$ )**

**R1171x151B**

$t_r=t_f=10\mu s$ ,  $V_{IN}=2.5V$ ,  $C_{OUT}=\text{Ceramic } 10\mu F$

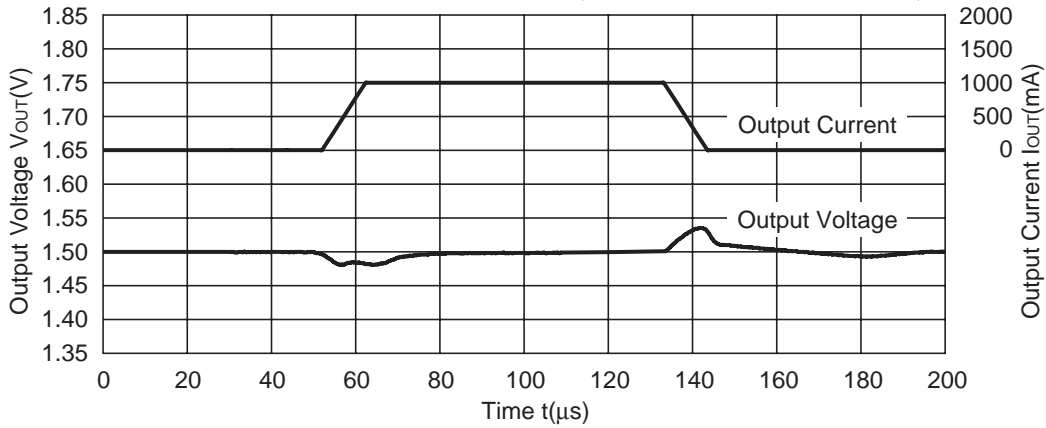

**R1171x201B**

$t_r=t_f=10\mu s$ ,  $V_{IN}=3.0V$ ,  $C_{OUT}=\text{Ceramic } 4.7\mu F$

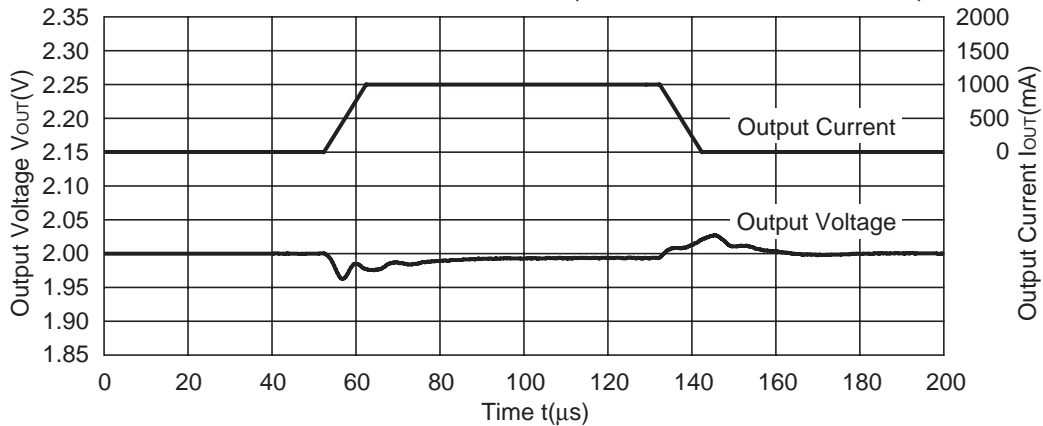

**R1171x301B**

$t_r=t_f=10\mu s$ ,  $V_{IN}=4.0V$ ,  $C_{OUT}=\text{Ceramic } 4.7\mu F$

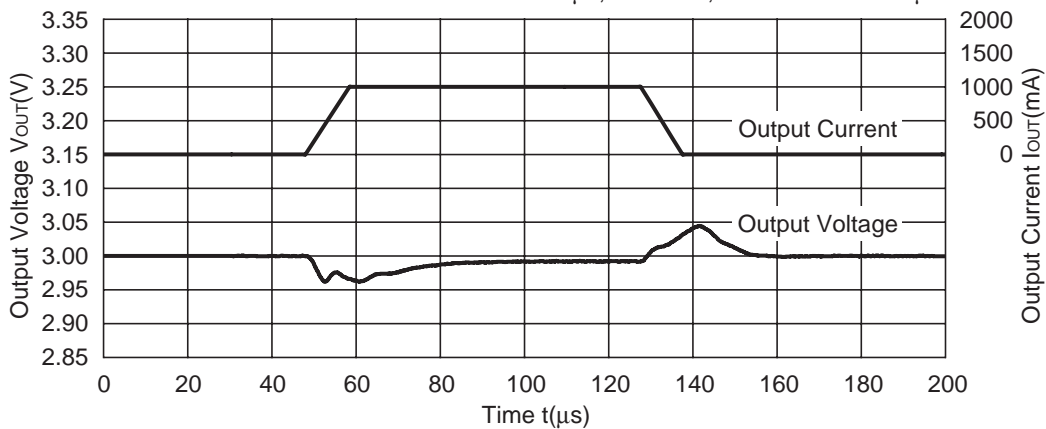

**R1171x501B**

$t_r=t_f=10\mu s$ ,  $V_{IN}=6.0V$ ,  $C_{OUT}=\text{Ceramic } 4.7\mu F$

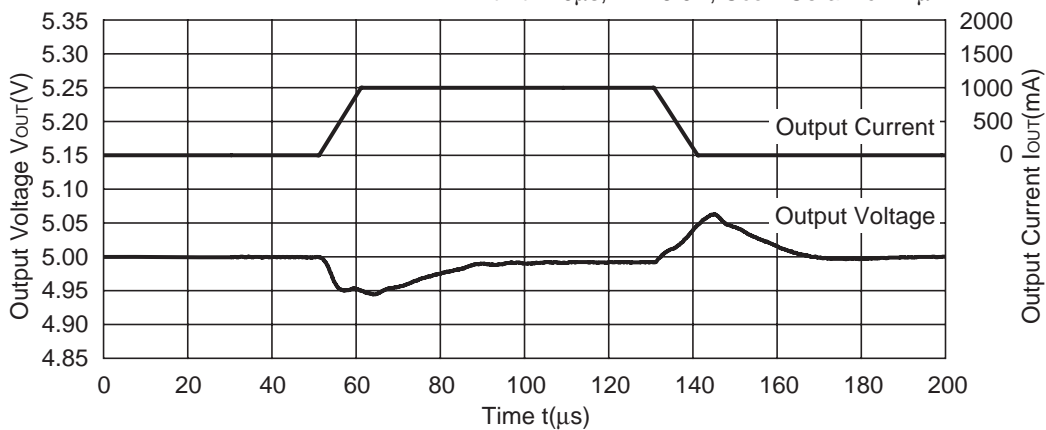

## Technical Notes on External Components and Typical Application

### 1. Phase Compensation

In these ICs, phase compensation is made with the output capacitor for securing stable operation even if the load current is varied. For this purpose, use a capacitor with the capacitance range from  $4.7\mu\text{F}$  to  $10.0\mu\text{F}$ , as  $C_L$ . In case that using a tantalum capacitor and the ESR of the tantalum capacitor is too large, unstable operation may result. Fully evaluation is necessary for the whole circuit with considering the frequency characteristic.

### 2. Mounting on PCB

Make  $V_{DD}$  and GND lines sufficient. If their impedance is high, large current may flow and the pick-up noise or unstable operation may result. Therefore use a capacitor with a capacitance range from  $4.7\mu\text{F}$  to  $10.0\mu\text{F}$  between  $V_{DD}$  pin and GND pin as close as possible.

Further, set an output capacitor between  $V_{OUT}$  pin and GND pin for phase compensation as close as possible. (Refer to the example of typical application)

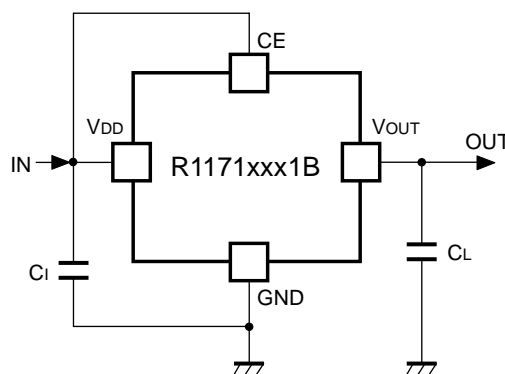

**R1171Sxx1B Typical Application**

$1.5\text{V} \leq V_{OUT} < 1.8\text{V}$  :  $C_i=10\mu\text{F}$  (Ceramic),  $C_L=10\mu\text{F}$  (Ceramic)

$1.8\text{V} \leq V_{OUT} \leq 5.0\text{V}$  :  $C_i=4.7\mu\text{F}$  (Ceramic),  $C_L=4.7\mu\text{F}$  (Ceramic)

### 3. Output Short Protection Function

In the R1171x Series, the output short protection function is built in, further, if the output is short to the GND or other voltage line, the chip inside is heating, as a result, in case that the junction temperature becomes equal or more than  $150^\circ\text{C}$  (Typ.), the built-in thermal shutdown circuit works. If the junction temperature becomes equal or more than  $150^\circ\text{C}$  (Typ.), the IC is protected by the output short protection circuit and the thermal shutdown circuit.

## ESR vs. Output Current (T<sub>opt</sub>=25°C, V<sub>IN</sub>=Set Output Voltage+1V, C<sub>IN</sub>=Ceramic 10μF)

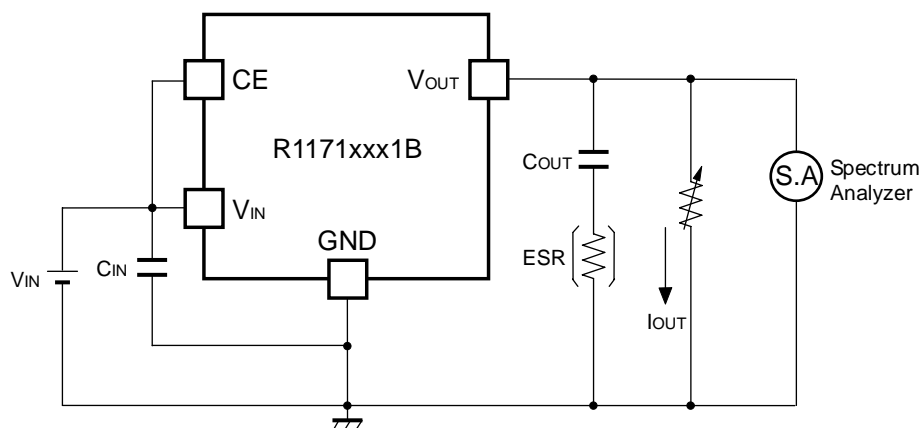

As an output capacitor for this IC, Ceramic capacitor is recommendable. However, other low ESR type capacitor can be used with this IC.

For your reference, noise level is tested with the circuit as shown above, and if the noise level is 40μV or less than 40μV, the ESR values are plotted as stable area. Upper limit is described in the next four graphs, or ESR vs. Output Current. (Hatched area is the stable area.)

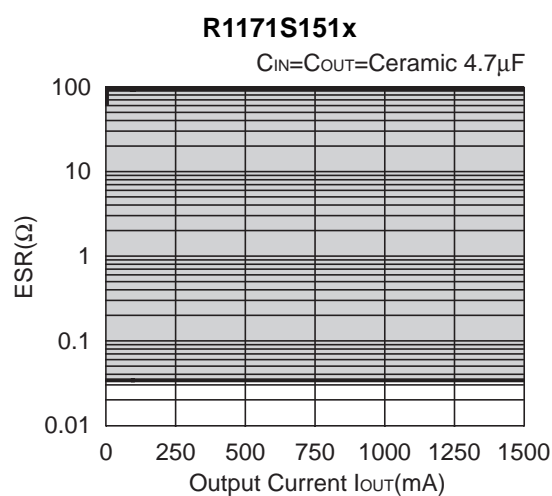
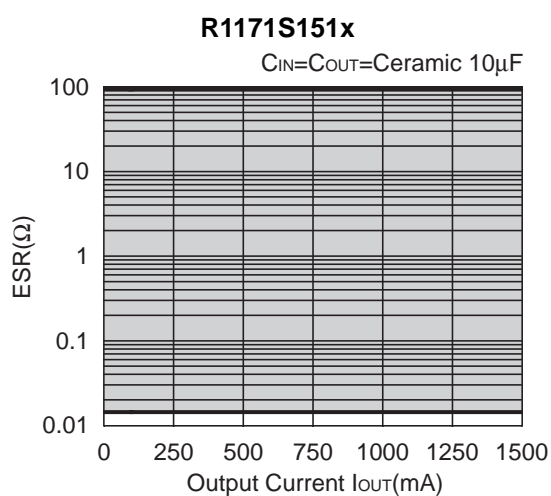

**R1171S301x**

$C_{IN}=C_{OUT}=\text{Ceramic } 4.7\mu\text{F}$

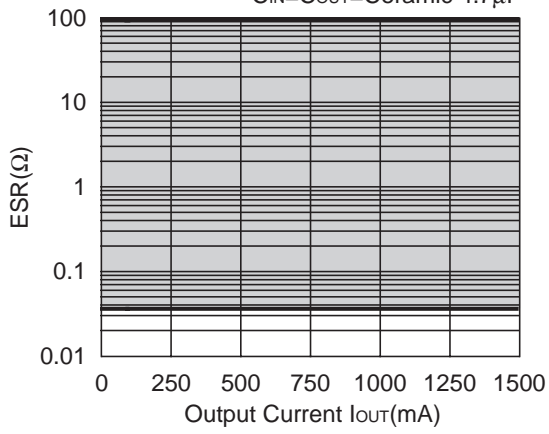

**R1171S301x**

$C_{IN}=C_{OUT}=\text{Ceramic } 2.2\mu\text{F}$

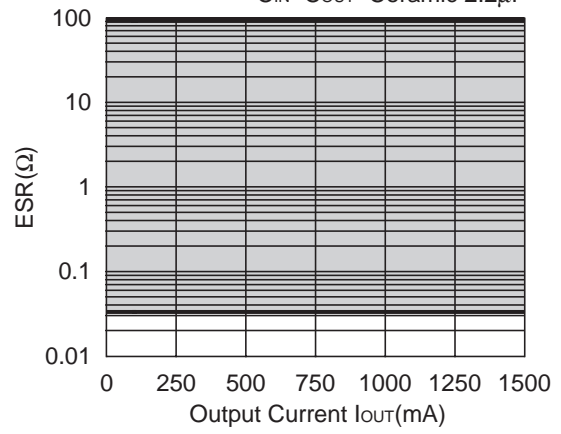

**R1171S501x**

$C_{IN}=C_{OUT}=\text{Ceramic } 4.7\mu\text{F}$

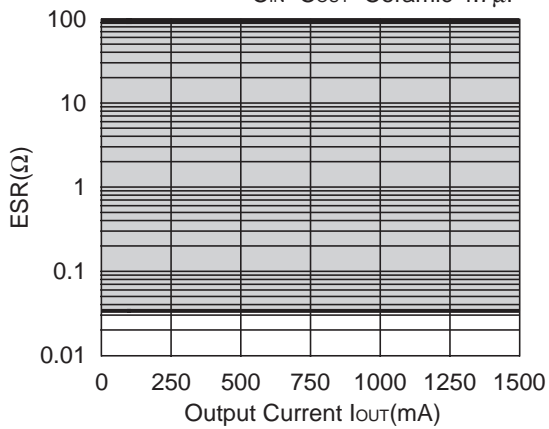

**R1171S501x**

$C_{IN}=C_{OUT}=\text{Ceramic } 2.2\mu\text{F}$

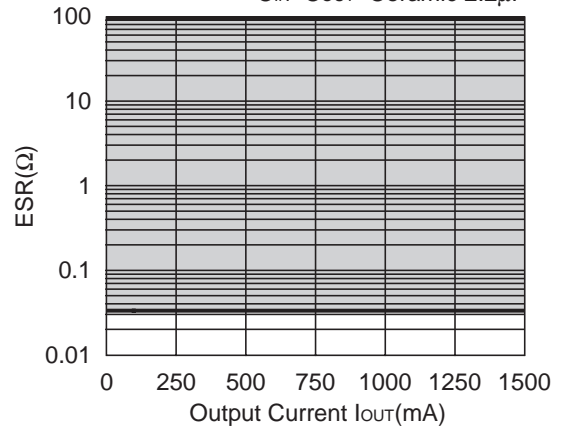

**R1171J181x**

$C_{IN}=C_{OUT}=\text{Ceramic } 4.7\mu\text{F}$

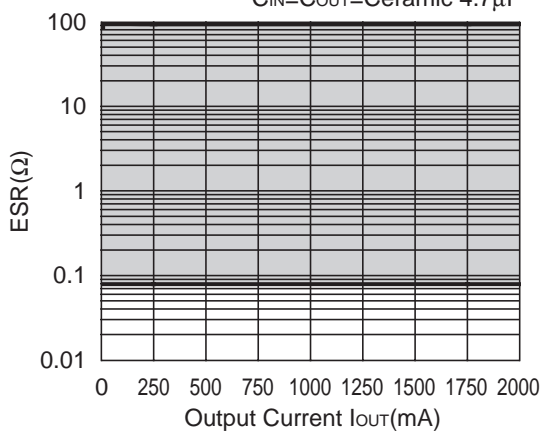

**R1171J181x**

$C_{IN}=C_{OUT}=\text{Ceramic } 2.2\mu\text{F}$

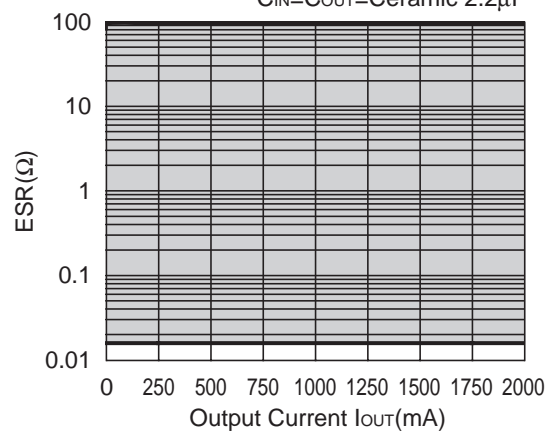

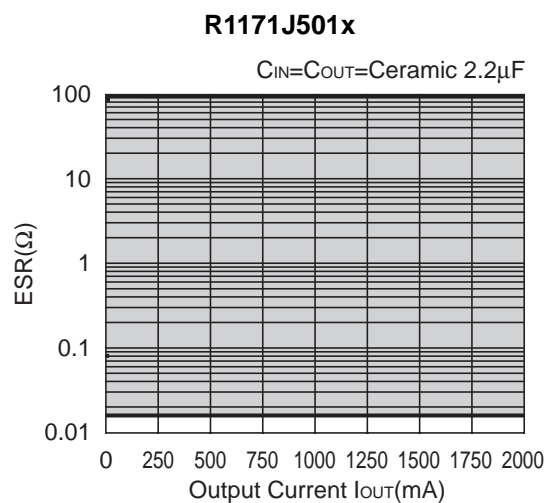
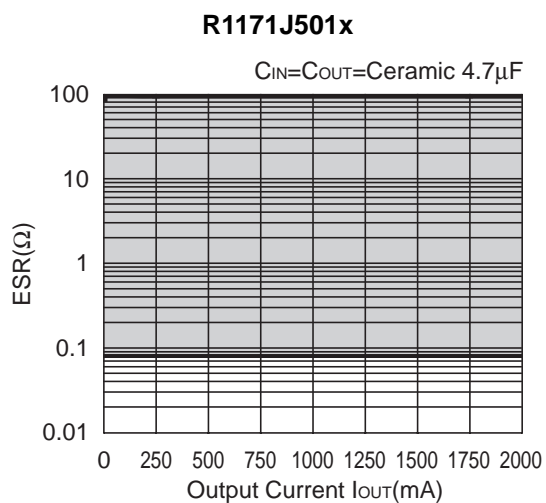
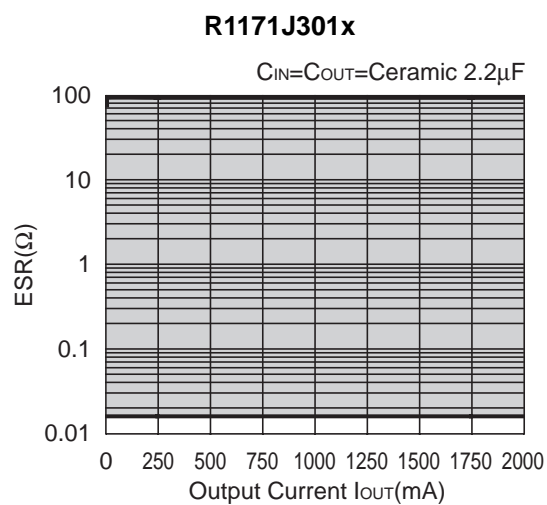
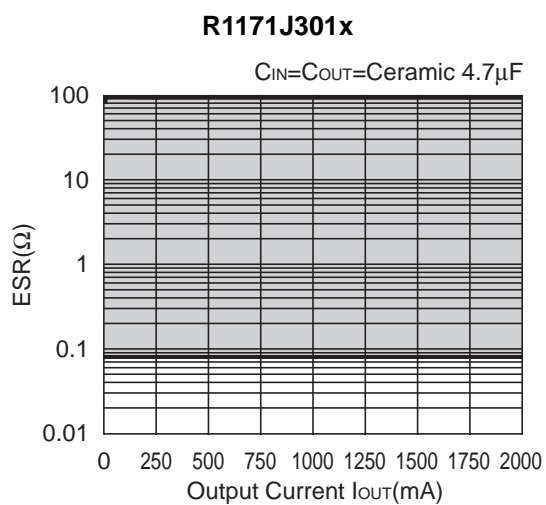



1. The products and the product specifications described in this document are subject to change or discontinuation of production without notice for reasons such as improvement. Therefore, before deciding to use the products, please refer to Ricoh sales representatives for the latest information thereon.
2. The materials in this document may not be copied or otherwise reproduced in whole or in part without prior written consent of Ricoh.
3. Please be sure to take any necessary formalities under relevant laws or regulations before exporting or otherwise taking out of your country the products or the technical information described herein.
4. The technical information described in this document shows typical characteristics of and example application circuits for the products. The release of such information is not to be construed as a warranty of or a grant of license under Ricoh's or any third party's intellectual property rights or any other rights.
5. The products listed in this document are intended and designed for use as general electronic components in standard applications (office equipment, telecommunication equipment, measuring instruments, consumer electronic products, amusement equipment etc.). Those customers intending to use a product in an application requiring extreme quality and reliability, for example, in a highly specific application where the failure or misoperation of the product could result in human injury or death (aircraft, spacevehicle, nuclear reactor control system, traffic control system, automotive and transportation equipment, combustion equipment, safety devices, life support system etc.) should first contact us.
6. We are making our continuous effort to improve the quality and reliability of our products, but semiconductor products are likely to fail with certain probability. In order to prevent any injury to persons or damages to property resulting from such failure, customers should be careful enough to incorporate safety measures in their design, such as redundancy feature, fire containment feature and fail-safe feature. We do not assume any liability or responsibility for any loss or damage arising from misuse or inappropriate use of the products.
7. Anti-radiation design is not implemented in the products described in this document.
8. Please contact Ricoh sales representatives should you have any questions or comments concerning the products or the technical information.



**Ricoh is committed to reducing the environmental loading materials in electrical devices with a view to contributing to the protection of human health and the environment.**

Ricoh has been providing RoHS compliant products since April 1, 2006 and Halogen-free products since April 1, 2012.

**RICOH** RICOH ELECTRONIC DEVICES CO., LTD.

<http://www.e-devices.ricoh.co.jp/en/>

#### Sales & Support Offices

##### **RICOH ELECTRONIC DEVICES CO., LTD.**

**Higashi-Shinagawa Office (International Sales)**  
3-32-3, Higashi-Shinagawa, Shinagawa-ku, Tokyo 140-8655, Japan  
Phone: +81-3-5479-2857 Fax: +81-3-5479-0502

##### **RICOH EUROPE (NETHERLANDS) B.V.**

**Semiconductor Support Centre**  
Prof. W.H. Keesomlaan 1, 1183 DJ Amstelveen, The Netherlands  
Phone: +31-20-5474-309

##### **RICOH ELECTRONIC DEVICES KOREA CO., LTD.**

3F, Haesung Bldg. 504, Teheran-ro, Gangnam-gu, Seoul, 135-725, Korea  
Phone: +82-2-2135-5700 Fax: +82-2-2051-5713

##### **RICOH ELECTRONIC DEVICES SHANGHAI CO., LTD.**

Room 403, No.2 Building, No.690 Bilbo Road, Pu Dong New District, Shanghai 201203,  
People's Republic of China  
Phone: +86-21-5027-3200 Fax: +86-21-5027-3299

##### **RICOH ELECTRONIC DEVICES CO., LTD.**

**Taipei office**  
Room 109, 10F-1, No.51, Hengyang Rd., Taipei City, Taiwan (R.O.C.)  
Phone: +886-2-2313-1621/1622 Fax: +886-2-2313-1623



# Mouser Electronics

Authorized Distributor

Click to View Pricing, Inventory, Delivery & Lifecycle Information:

[Ricoch Electronics:](#)

[R1171S421B-E2-FE](#) [R1171S251B-E2-FE](#)

Компания «Океан Электроники» предлагает заключение долгосрочных отношений при поставках импортных электронных компонентов на взаимовыгодных условиях!

Наши преимущества:

- Поставка оригинальных импортных электронных компонентов напрямую с производств Америки, Европы и Азии, а так же с крупнейших складов мира;
- Широкая линейка поставок активных и пассивных импортных электронных компонентов (более 30 млн. наименований);
- Поставка сложных, дефицитных, либо снятых с производства позиций;
- Оперативные сроки поставки под заказ (от 5 рабочих дней);
- Экспресс доставка в любую точку России;
- Помощь Конструкторского Отдела и консультации квалифицированных инженеров;
- Техническая поддержка проекта, помощь в подборе аналогов, поставка прототипов;
- Поставка электронных компонентов под контролем ВП;
- Система менеджмента качества сертифицирована по Международному стандарту ISO 9001;
- При необходимости вся продукция военного и аэрокосмического назначения проходит испытания и сертификацию в лаборатории (по согласованию с заказчиком);
- Поставка специализированных компонентов военного и аэрокосмического уровня качества (Xilinx, Altera, Analog Devices, Intersil, Interpoint, Microsemi, Actel, Aeroflex, Peregrine, VPT, Syfer, Eurofarad, Texas Instruments, MS Kennedy, Miteq, Cobham, E2V, MA-COM, Hittite, Mini-Circuits, General Dynamics и др.);

Компания «Океан Электроники» является официальным дистрибьютором и эксклюзивным представителем в России одного из крупнейших производителей разъемов военного и аэрокосмического назначения «JONHON», а так же официальным дистрибьютором и эксклюзивным представителем в России производителя высокотехнологичных и надежных решений для передачи СВЧ сигналов «FORSTAR».



## JONHON

«JONHON» (основан в 1970 г.)

Разъемы специального, военного и аэрокосмического назначения:

(Применяются в военной, авиационной, аэрокосмической, морской, железнодорожной, горно- и нефтедобывающей отраслях промышленности)

«FORSTAR» (основан в 1998 г.)

ВЧ соединители, коаксиальные кабели,  
кабельные сборки и микроволновые компоненты:

(Применяются в телекоммуникациях гражданского и специального назначения, в средствах связи, РЛС, а так же военной, авиационной и аэрокосмической отраслях промышленности).



Телефон: 8 (812) 309-75-97 (многоканальный)

Факс: 8 (812) 320-03-32

Электронная почта: [ocean@oceanchips.ru](mailto:ocean@oceanchips.ru)

Web: <http://oceanchips.ru/>

Адрес: 198099, г. Санкт-Петербург, ул. Калинина, д. 2, корп. 4, лит. А