

GENERAL SPECIFICATIONS FOR S301 ~ S339

Toggles
A

Rockers

Pushbuttons

Illuminated PB

Programmable

Keylocks

Rotaries

Slides

Tactiles

Tilt

Touch

Indicators

Accessories

Supplement

Electrical Capacity (Resistive & Inductive Load)

Power Level: Shown in the following tables

Other Ratings

| | |
|--|--|
| Contact Resistance: | 10 milliohms maximum |
| Insulation Resistance: | 1,000 megohms minimum @ 500V DC |
| Dielectric Strength: | 2,000V AC minimum for 1 minute minimum |
| Mechanical Life: | 50,000 operations minimum |
| Electrical Life: | 6,000 operations minimum for S331F; 15,000 operations minimum for all other S331s; 25,000 operations minimum for all others |
| Angle of Throw (α): | Shown on following tables |

Materials & Finishes

| | |
|---|---|
| Toggle: | PBT for flatted lever; brass with chrome plating for all others |
| Bushing: | Brass with chrome plating |
| Case: | Melamine phenol |
| Case Cover: | Steel with zinc plating |
| Movable Contactor: | Copper with silver plating |
| Movable & Stationary Contacts: | Silver alloy capped on copper with silver plating |
| Terminals: | Brass with tin plating |

Environmental Data

Operating Temperature Range: $-10^{\circ}\text{C} \sim +70^{\circ}\text{C}$ ($+14^{\circ}\text{F} \sim +158^{\circ}\text{F}$)

Installation

Mounting Torque: 2.94Nm (26 lb•in) for double nut; 1.47Nm (13 lb•in) for single nut
Soldering Time & Temperature: Manual Soldering: See Profile A in Supplement section.

Standards & Certifications

- UL:** File No. E44145 - Recognized only when ordered with marking on switch. Add "/U" or "/CUL" to end of part number to order UL recognized switch. UL or cULus recognition designated beside part numbers on following pages. See Supplement section to find UL or cULus rating details.
- CSA:** File No. 023535_0_000 - Certified only when ordered with marking on switch. Add "/C" to end of part number to order CSA certified switch. CSA certification designated beside part numbers on following pages. See Supplement section to find CSA rating details.

SINGLE POLE WITH SOLDER LUG *

| * UL, cULus & CSA recognized only when ordered with marking on switch (see General Specs) | | | Toggle Position/Connected Terminals () = Momentary | | | | | | Electrical Capacity | | | |
|---|-------------|-------|--|--------------|----------------|--------|----------|-----------|---------------------|--------|--------------------------------|----------------|
| Model | * Approvals | | | Pole & Throw | Down Keyway | Center | Up | Resistive | | | Inductive AC 125V PF 0.6 | Angle of Throw |
| | UL | cULus | CSA | | | | | AC 125V | AC 250V | DC 30V | | |
| S301 | ✓ | ✓ | ✓ | SPST | ON 1-3 | NONE | OFF — | 15A | 6A | 20A | 10A | 32° |
| S302 | ✓ | ✓ | ✓ | SPDT | ON 2-3 | NONE | ON 2-1 | 15A | 6A | 20A | 10A | 32° |
| S303 | ✓ | ✓ | ✓ | SPDT | ON 2-3 | OFF | ON 2-1 | 15A | 6A | 20A | 10A | 32° |
| S305 | — | — | ✓ | SPDT | ON 2-3 | NONE | (ON) 2-1 | 15A | 6A | 20A | 8A | 32° |
| S308 | — | — | ✓ | SPDT | (ON) 2-3 | OFF | (ON) 2-1 | 15A | 6A | 20A | 8A | 32° |
| S309 | — | — | ✓ | SPDT | ON 2-3 | OFF | (ON) 2-1 | 15A | 6A | 20A | 8A | 32° |

Throw & Schematics: SPST INTERNAL CONNECTION SPDT

Note: Terminal numbers are actually on the switch

Notes: Standard Hardware: AT503M Face Hex Nut, AT506M Locking Ring, AT508 Lockwasher, AT527M Backup Hex Nut. See Accessories & Hardware section.
Optional Splashproof Boot Assemblies: AT401 & AT4181 boots plus hex nut & o-ring. See Accessories & Hardware section.

* Wire harness & cable assemblies offered only in Americas.



DOUBLE POLE WITH SOLDER LUG *

| * UL, cULus & CSA recognized only when ordered with marking on switch (see General Specs) | | | Toggle Position/Connected Terminals () = Momentary | | | | | | Electrical Capacity | | | |
|---|-------------|-------|--|--------------|----------------|--------|--------------|-----------|---------------------|--------|--------------------------------|---------------------------|
| Model | * Approvals | | | Pole & Throw | Down Keyway | Center | Up | Resistive | | | Inductive AC 125V PF 0.6 | α = Angle of Throw |
| | UL | cULus | CSA | | | | | AC 125V | AC 250V | DC 30V | | |
| S331 | ✓ | ✓ | ✓ | DPST | ON 1-3 4-6 | NONE | OFF — | 25A | 25A | 25A | 10A | 25° |
| S332 | ✓ | ✓ | ✓ | DPDT | ON 2-3 5-6 | NONE | ON 2-1 5-4 | 25A | 15A | 25A | 10A | 25° |
| S333 | ✓ | ✓ | ✓ | DPDT | ON 2-3 5-6 | OFF | ON 2-1 5-4 | 25A | 15A | 25A | 10A | 30° |
| S335 | ✓ | ✓ | ✓ | DPDT | ON 2-3 5-6 | NONE | (ON) 2-1 5-4 | 15A | 6A | 20A | 8A | 25° |
| S338 | ✓ | ✓ | — | DPDT | (ON) 2-3 5-6 | OFF | (ON) 2-1 5-4 | 15A | 6A | 20A | 8A | 25° |
| S339 | ✓ | ✓ | — | DPDT | ON 2-3 5-6 | OFF | (ON) 2-1 5-4 | 15A | 6A | 20A | 8A | 25° |

Throw & Schematics: DPST INTERNAL CONNECTION DPDT

Note: Terminal numbers are actually on the switch

Notes: Standard Hardware: AT503M Face Hex Nut, AT506M Locking Ring, AT508 Lockwasher, AT527M Backup Hex Nut. See Accessories & Hardware section.
Optional Splashproof Boot Assemblies: AT401 & AT4181 boots plus hex nut & o-ring. See Accessories & Hardware section.

* Wire harness & cable assemblies offered only in Americas.

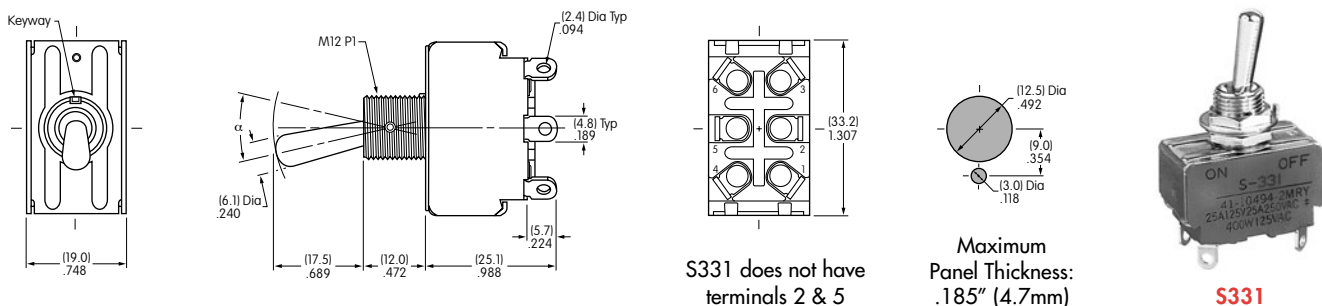

DOUBLE POLE WITH SOLDER LUG & FLATTED LEVER *

| Model | * Approvals | | | Pole & Throw | Toggle Position/Connected Terminals () = Momentary | | | | | | Electrical Capacity | | | |
|-------|-------------|-------|----|--------------|---|---|---|-----------|---------|--------|--------------------------------|---------------------------------|--|--|
| | UL | cULus | SE | | Down  | Center  | Up  | Resistive | | | Inductive AC 125V PF 0.6 | α = Angle of Throw | | |
| | | | | | | | | AC 125V | AC 250V | DC 30V | | | | |
| S331R | ✓ | ✓ | — | DPST | ON 1-3 4-6 | NONE | OFF — | 25A | 25A | 25A | 10A | 25° | | |
| S332R | ✓ | ✓ | — | DPDT | 2-3 5-6 | NONE | ON 2-1 5-4 | 25A | 15A | 25A | 10A | 25° | | |
| S333R | ✓ | ✓ | — | DPDT | ON 2-3 5-6 | OFF | ON 2-1 5-4 | 25A | 15A | 25A | 10A | 30° | | |
| S338R | ✓ | ✓ | — | DPDT | (ON) 2-3 5-6 | OFF | (ON) 2-1 5-4 | 15A | 6A | 20A | 8A | 25° | | |
| S339R | ✓ | ✓ | — | DPDT | ON 2-3 5-6 | OFF | (ON) 2-1 5-4 | 15A | 6A | 20A | 8A | 25° | | |



Note: Terminal numbers are actually on the switch

Notes: Standard Hardware: AT504M Knurled Nut, AT508 Lockwasher, AT527M Backup Hex Nut. See Accessories & Hardware section.

* Wire harness & cable assemblies offered only in Americas.



S331R

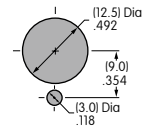
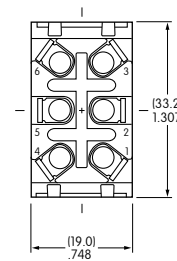
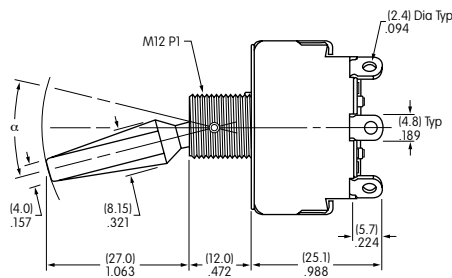
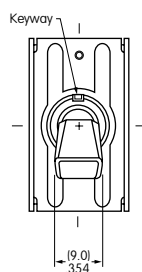



S331R does not have terminals 2 & 5

Maximum Panel Thickness: .220" (5.6mm)

SINGLE POLE WITH SCREW LUG

| * UL, cULus & CSA recognized only when ordered with marking on switch (see General Specs) | | | Toggle Position/Connected Terminals () = Momentary | | | | | Electrical Capacity | | | | α = Angle of Throw |
|---|---|---|---|--------------|---|---|---|---------------------|---------|--------|----------------|---------------------------|
| Model | * Approvals | | | Pole & Throw | Down  | Center  | Up  | Resistive | | | Inductive | |
| |  |  |  | | | | | AC 125V | AC 250V | DC 30V | AC 125V PF 0.6 | |
| S301T | ✓ | ✓ | ✓ | SPST | ON 1-3 | NONE | OFF — | 15A | 6A | 20A | 10A | 32° |
| S302T | ✓ | ✓ | ✓ | SPDT | ON 2-3 | NONE | ON 2-1 | 15A | 6A | 20A | 10A | 32° |
| S303T | ✓ | ✓ | ✓ | SPDT | ON 2-3 | OFF | ON 2-1 | 15A | 6A | 20A | 10A | 32° |
| S305T | — | — | ✓ | SPDT | ON 2-3 | NONE | (ON) 2-1 | 15A | 6A | 20A | 8A | 32° |
| S308T | — | — | ✓ | SPDT | (ON) 2-3 | OFF | (ON) 2-1 | 15A | 6A | 20A | 8A | 32° |
| S309T | — | — | ✓ | SPDT | ON 2-3 | OFF | (ON) 2-1 | 15A | 6A | 20A | 8A | 32° |

Throw & Schematics: SPST  INTERNAL CONNECTION  Note: Terminal numbers are actually on the switch

Notes: Standard Hardware: AT503M Face Hex Nut, AT506M Locking Ring, AT508 Lockwasher, AT527M Backup Hex Nut. See Accessories & Hardware section. Optional Splashproof Boot Assemblies: AT401 & AT4181 boots plus hex nut & o-ring. See Accessories & Hardware section.

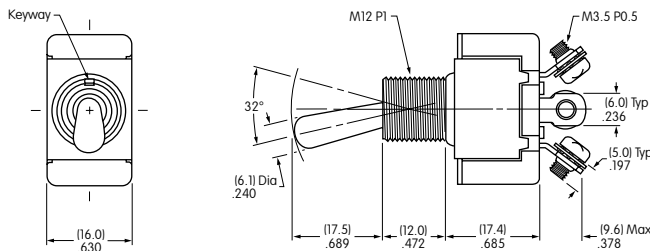

S301T does not have terminal 2

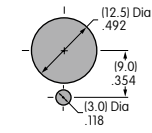

Maximum Panel Thickness: .185" (4.7mm)



S301T

DOUBLE POLE WITH SCREW LUG

| * UL & cULus recognized only when ordered with marking on switch (see General Specs) | | | Toggle Position/Connected Terminals () = Momentary | | | | | Electrical Capacity | | | | α = Angle of Throw |
|--|---|---|---|--------------|---|---|---|---------------------|---------|--------|----------------|---------------------------|
| Model | * Approvals | | | Pole & Throw | Down  | Center  | Up  | Resistive | | | Inductive | |
| |  |  |  | | | | | AC 125V | AC 250V | DC 30V | AC 125V PF 0.6 | |
| S331T | ✓ | ✓ | — | DPST | ON 1-3 4-6 | NONE | OFF — | 15A | 15A | 15A | 10A | 25° |
| S332T | ✓ | ✓ | — | DPDT | ON 2-3 5-6 | NONE | ON 2-1 5-4 | 15A | 15A | 15A | 10A | 25° |
| S333T | ✓ | ✓ | — | DPDT | ON 2-3 5-6 | OFF | ON 2-1 5-4 | 15A | 15A | 15A | 10A | 30° |
| S335T | ✓ | ✓ | — | DPDT | ON 2-3 5-6 | NONE | (ON) 2-1 5-4 | 15A | 6A | 20A | 8A | 25° |
| S338T | ✓ | ✓ | — | DPDT | (ON) 2-3 5-6 | OFF | (ON) 2-1 5-4 | 15A | 6A | 20A | 8A | 25° |
| S339T | ✓ | ✓ | — | DPDT | ON 2-3 5-6 | OFF | (ON) 2-1 5-4 | 15A | 6A | 20A | 8A | 25° |

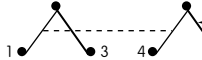
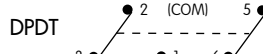
Throw & Schematics: DPST  INTERNAL CONNECTION  Note: Terminal numbers are actually on the switch

Notes: Standard Hardware: AT503M Face Hex Nut, AT506M Locking Ring, AT508 Lockwasher, AT527M Backup Hex Nut. See Accessories & Hardware section. Optional Splashproof Boot Assemblies: AT401 & AT4181 boots plus hex nut & o-ring. See Accessories & Hardware section.

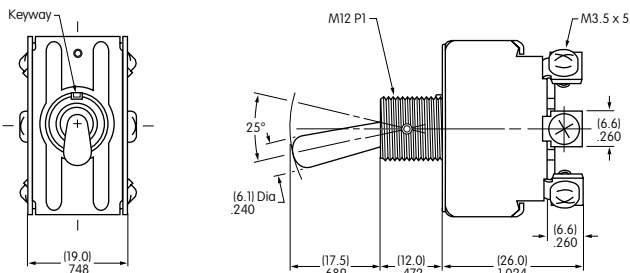

S331T does not have terminals 2 & 5

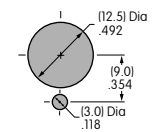

Maximum Panel Thickness: .185" (4.7mm)



S331T

Toggles **A**

Rockers

Pushbuttons

Illuminated PB

Programmable

Keylocks

Rotaries

Slides

Tactiles

Tilt

Touch

Indicators

Accessories

Supplement

SINGLE POLE WITH QUICK CONNECT

| * UL, cULus & CSA recognized only when ordered with marking on switch (see General Specs) | | | | Toggle Position/Connected Terminals | | | Electrical Capacity | | | | $\alpha =$ Angle of Throw | |
|---|-------------|---|---|-------------------------------------|--------|--------|---------------------|-----------|---------|--------|------------------------------|----------------|
| Model | * Approvals | | | Pole & Throw | Down | Center | Up | Resistive | | | | Inductive |
| | | | | | | | | AC 125V | AC 250V | DC 30V | | AC 125V PF 0.6 |
| S301F | ✓ | ✓ | ✓ | SPST | ON 1-3 | NONE | OFF — | 15A | 6A | 20A | 10A | 32° |

Throw & Schematics: SPST INTERNAL CONNECTION

Note: Terminal numbers are actually on the switch

Notes: Standard Hardware: AT503M Face Hex Nut, AT506M Locking Ring, AT508 Lockwasher, AT527M Backup Hex Nut. See Accessories & Hardware section. Optional Splashproof Boot Assemblies: AT401 & AT4181 boots plus hex nut & o-ring. See Accessories & Hardware section.



S301F

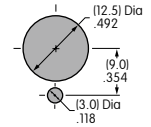
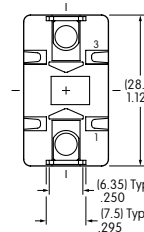
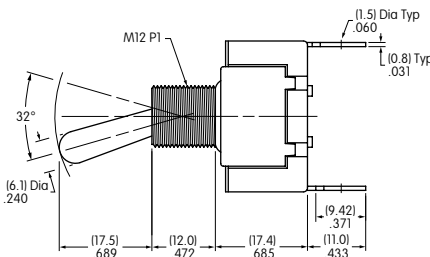

Maximum Panel Thickness: .185" (4.7mm)

DOUBLE POLE WITH QUICK CONNECT

| * UL & cULus recognized only when ordered with marking on switch (see General Specs) | | | | Toggle Position/Connected Terminals () = Momentary | | | Electrical Capacity | | | | $\alpha =$ Angle of Throw | |
|--|-------------|---|---|--|------------|--------|---------------------|-----------|---------|--------|------------------------------|----------------|
| Model | * Approvals | | | Pole & Throw | Down | Center | Up | Resistive | | | | Inductive |
| | | | | | | | | AC 125V | AC 250V | DC 30V | | AC 125V PF 0.6 |
| S331F | ✓ | ✓ | — | DPST | ON 1-3 4-6 | NONE | OFF — | 25A | 25A | 25A | 10A | 25° |
| S332F | ✓ | ✓ | — | DPDT | ON 2-3 5-6 | NONE | ON 2-1 5-4 | 25A | 15A | 25A | 10A | 25° |
| S333F | ✓ | ✓ | — | DPDT | ON 2-3 5-6 | OFF | ON 2-1 5-4 | 25A | 15A | 25A | 10A | 30° |
| S335F | ✓ | ✓ | — | DPDT | ON 2-3 5-6 | NONE | (ON) 2-1 5-4 | 15A | 6A | 20A | 8A | 25° |

Throw & Schematics: DPST INTERNAL CONNECTION DPDT INTERNAL CONNECTION

Note: Terminal numbers are actually on the switch

Notes: Standard Hardware: AT503M Face Hex Nut, AT506M Locking Ring, AT508 Lockwasher, AT527M Backup Hex Nut. See Accessories & Hardware section. Optional Splashproof Boot Assemblies: AT401 & AT4181 boots plus hex nut & o-ring. See Accessories & Hardware section.



S332F

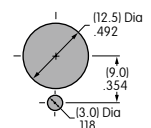
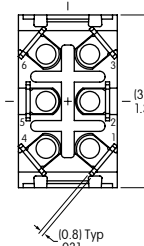
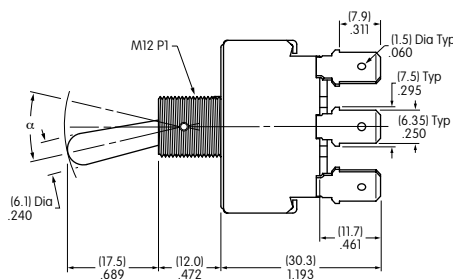

Maximum Panel Thickness: .185" (4.7mm)

S331F does not have terminals 2 & 5

GENERAL SPECIFICATIONS FOR S31 ~ S49

Electrical Capacity (Resistive & Inductive Load)

Power Level: Shown in the following tables

Other Ratings

Contact Resistance: 10 milliohms maximum
Insulation Resistance: 1,000 megohms minimum @ 500V DC
Dielectric Strength: 2,000V AC minimum for 1 minute minimum
Mechanical Life: 50,000 operations minimum
Electrical Life: 25,000 operations minimum
Angle of Throw (α): Shown on following tables

Materials & Finishes

Toggle: PBT resin for flatted lever; brass with chrome plating for all others
Bushing: Brass with chrome plating
Case: Phenolic resin
Case Cover: Steel with chromate plating over zinc plating
Movable Contact: Copper with silver plating
Movable Contacts: Silver alloy capped on copper with silver plating
Stationary Contacts: Silver alloy capped on copper with silver plating
Terminals: Brass with tin plating

Environmental Data

Operating Temp Range: -10°C through +70°C (+14°F through +158°F)

Installation

Mounting Torque: 2.94Nm (26 lb•in) for double nut
Maximum Panel Thickness: Shown beneath panel cutout in switch dimension drawings
Soldering Time & Temperature: Manual Soldering: See Profile A in Supplement section.

Standards & Certifications

UL: File No. E44145 - **Recognized only when ordered with marking on switch.**
 Add "/U" or "/CUL" to end of part number to order UL recognized switch.
 UL or cULus recognition designated beside part numbers on following pages.
 See Supplement section to find UL or cULus rating details.

CSA: File No. 023535_0_000 - **Certified only when ordered with marking on switch.**
 Add "/C" to end of part number to order CSA certified switch.
 CSA certification designated beside part numbers on following pages.
 See Supplement section to find CSA rating details.

A
Toggles

Rockers

Pushbuttons

Illuminated PB

Programmable

Keylocks

Rotaries

Slides

Tactiles

Tilt

Touch

Indicators

Accessories

Supplement

Toggles **A**

THREE POLE WITH SOLDER LUG *

| * UL, cULus & CSA recognized only when ordered with marking on switch (see General Specs) | | | | Toggle Position/Connected Terminals () = Momentary | | | | | | | Electrical Capacity | | | | |
|---|-------------|-------|-----|--|----------------|-------------|------|-----------|-------------|--------|--------------------------------|---------------------------------|-----|-----|--|
| Model | * Approvals | | | Pole & Throw | Down Keyway | Center | Up | Resistive | | | Inductive AC 125V PF 0.6 | α = Angle of Throw | | | |
| | UL | cULus | CSA | | | | | AC 125V | AC 250V | DC 30V | | | | | |
| S31 | ✓ | ✓ | ✓ | 3PST | ON | 1-3 4-6 7-9 | NONE | OFF | — | 25A | 9A | 20A | 10A | 25° | |
| S32 | ✓ | ✓ | ✓ | 3PDT | ON | 2-3 5-6 8-9 | NONE | ON | 2-1 5-4 8-7 | 25A | 9A | 20A | 10A | 25° | |
| S33 | ✓ | ✓ | ✓ | 3PDT | ON | 2-3 5-6 8-9 | OFF | ON | 2-1 5-4 8-7 | 25A | 9A | 20A | 10A | 30° | |
| S35 | ✓ | ✓ | ✓ | 3PDT | ON | 2-3 5-6 8-9 | NONE | (ON) | 2-1 5-4 8-7 | 15A | 6A | 20A | 8A | 25° | |
| S38 | ✓ | ✓ | ✓ | 3PDT | (ON) | 2-3 5-6 8-9 | OFF | (ON) | 2-1 5-4 8-7 | 15A | 6A | 15A | 8A | 25° | |
| S39 | ✓ | ✓ | ✓ | 3PDT | ON | 2-3 5-6 8-9 | OFF | (ON) | 2-1 5-4 8-7 | 15A | 6A | 15A | 8A | 25° | |



Notes: Standard Hardware: AT503M Face Hex Nut, AT506M Locking Ring, AT508 Lockwasher, AT527M Backup Hex Nut. See Accessories & Hardware section.
Optional Splashproof Boot Assemblies: AT401 & AT4181 boots plus hex nut & o-ring. See Accessories & Hardware section.

* Wire harness & cable assemblies offered only in Americas.

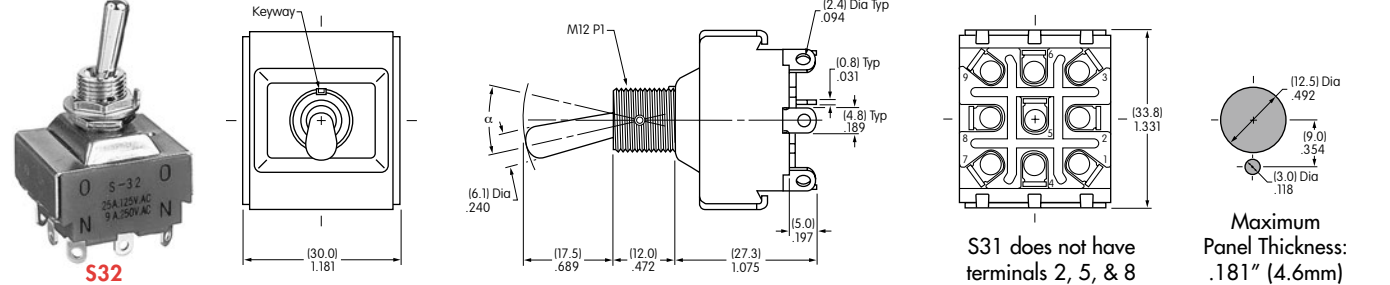

FOUR POLE WITH SOLDER LUG *

| * UL, cULus & CSA recognized only when ordered with marking on switch (see General Specs) | | | | Toggle Position/Connected Terminals () = Momentary | | | | | | | Electrical Capacity | | | | |
|---|-------------|-------|-----|--|----------------|-------------------|------|-----------|-------------------|--------|--------------------------------|---------------------------------|-----|-----|--|
| Model Suffix R = Flatted Lever | * Approvals | | | Pole & Throw | Down Keyway | Center | Up | Resistive | | | Inductive AC 125V PF 0.6 | α = Angle of Throw | | | |
| | UL | cULus | CSA | | | | | AC 125V | AC 250V | DC 30V | | | | | |
| S41/S41R | ✓ | ✓ | ✓ | 4PST | ON | 1-3 4-6 7-9 10-12 | NONE | OFF | — | 25A | 9A | 20A | 10A | 25° | |
| S42/S42R | ✓ | ✓ | ✓ | 4PDT | ON | 2-3 5-6 8-9 11-12 | NONE | ON | 2-1 5-4 8-7 11-10 | 25A | 9A | 20A | 10A | 25° | |
| S43/S43R | ✓ | ✓ | ✓ | 4PDT | ON | 2-3 5-6 8-9 11-12 | OFF | ON | 2-1 5-4 8-7 11-10 | 25A | 9A | 20A | 10A | 30° | |
| S45 | — | ✓ | — | 4PDT | ON | 2-3 5-6 8-9 11-12 | NONE | (ON) | 2-1 5-4 8-7 11-10 | 15A | 6A | 20A | 8A | 25° | |
| S48/S48R | ✓ | ✓ | — | 4PDT | (ON) | 2-3 5-6 8-9 11-12 | OFF | (ON) | 2-1 5-4 8-7 11-10 | 15A | 6A | 20A | 8A | 25° | |
| S49/S49R | ✓ | ✓ | — | 4PDT | ON | 2-3 5-6 8-9 11-12 | OFF | (ON) | 2-1 5-4 8-7 11-10 | 15A | 6A | 20A | 8A | 25° | |



Notes: Standard Hardware for **Bat Lever**: AT503M Face Hex Nut, AT506M Locking Ring, AT508 Lockwasher, AT527M Backup Hex Nut; for **Flatted Lever (R)**: AT504M Knurled Face Nut, AT508 Lockwasher, AT527M Backup Hex Nut. See Accessories & Hardware section.

Optional Splashproof Boot Assemblies (only for bat lever models): AT401 & AT4181 boots plus hex nut and o-ring. See Accessories & Hardware section.

* Wire harness & cable assemblies offered only in Americas.

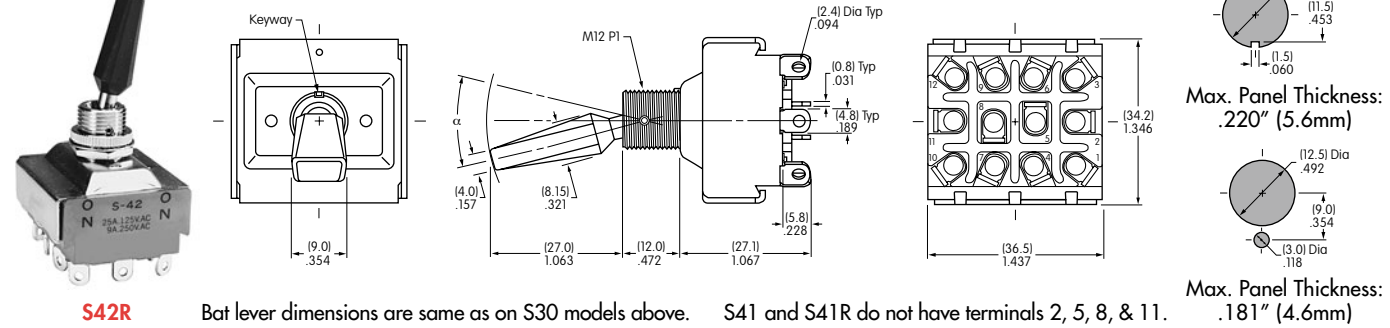

Bat lever dimensions are same as on S30 models above. S41 and S41R do not have terminals 2, 5, 8, & 11.

Rocker
Pushbuttons
Illuminated PB
Programmable
Keylocks
Rotaries
Slides
Tactiles
Tilt
Touch
Indicators
Accessories
Supplement

THREE POLE WITH SCREW LUG

| * UL, cULus & CSA recognized only when ordered with marking on switch (see General Specs) | | | Toggle Position/Connected Terminals | | | | | | Electrical Capacity | | | | | α = Angle of Throw |
|---|-------------|-------|-------------------------------------|--------------|---|---|---|-----------|---------------------|--------|----------------|----------------|-----|--------------------|
| Model | * Approvals | | | Pole & Throw | Down  | Center  | Up  | Resistive | | | Inductive | | | |
| | UL | cULus | CSA | | | | | AC 125V | AC 250V | DC 30V | AC 125V PF 0.6 | AC 250V PF 0.6 | | |
| S31T | ✓ | ✓ | ✓ | 3PST | ON 1-3 4-6 7-9 | NONE | OFF — | 25A | 9A | 20A | 10A | 5A | 25° | |
| S32T | ✓ | ✓ | ✓ | 3PDT | ON 2-3 5-6 8-9 | NONE | ON 2-1 5-4 8-7 | 25A | 9A | 20A | 10A | 5A | 25° | |
| S33T | ✓ | ✓ | ✓ | 3PDT | ON 2-3 5-6 8-9 | OFF | ON 2-1 5-4 8-7 | 25A | 9A | 20A | 10A | 5A | 30° | |

Throw & Schematics:

3PST:  INTERNAL CONNECTION

3PDT:  (COM)

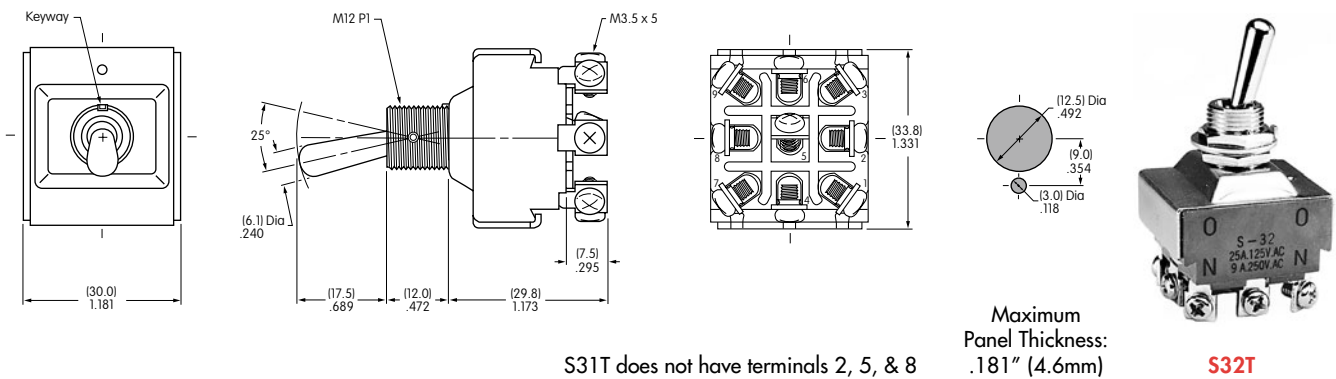

Note: Terminal numbers are on the switch

Notes: Standard Hardware: AT503M Face Hex Nut, AT506M Locking Ring, AT508 Lockwasher, AT527M Backup Hex Nut. See Accessories & Hardware section. Optional Splashproof Boot Assemblies: AT401 & AT4181 boots plus hex nut & o-ring. See Accessories & Hardware section.



S31T does not have terminals 2, 5, & 8

FOUR POLE WITH SCREW LUG

| * UL, cULus & CSA recognized only when ordered with marking on switch (see General Specs) | | | Toggle Position/Connected Terminals | | | | | | Electrical Capacity | | | | | α = Angle of Throw |
|---|-------------|-------|-------------------------------------|--------------|---|---|---|-----------|---------------------|--------|----------------|----------------|-----|--------------------|
| Model | * Approvals | | | Pole & Throw | Down  | Center  | Up  | Resistive | | | Inductive | | | |
| | UL | cULus | CSA | | | | | AC 125V | AC 250V | DC 30V | AC 125V PF 0.6 | AC 250V PF 0.6 | | |
| S41T | ✓ | ✓ | ✓ | 4PST | ON 1-3 4-6 7-9 10-12 | NONE | OFF — | 25A | 9A | 20A | 10A | 5A | 25° | |
| S42T | ✓ | ✓ | ✓ | 4PDT | ON 2-3 5-6 8-9 11-12 | NONE | ON 2-1 5-4 8-7 11-10 | 25A | 9A | 20A | 10A | 5A | 25° | |
| S43T | ✓ | ✓ | ✓ | 4PDT | ON 2-3 5-6 8-9 11-12 | OFF | ON 2-1 5-4 8-7 11-10 | 25A | 9A | 20A | 10A | 5A | 30° | |

Throw & Schematics:

4PST:  INTERNAL CONNECTION

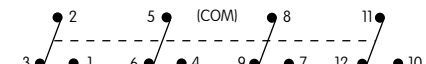
4PDT:  (COM)

Note: Terminal numbers are on the switch

Notes: Standard Hardware: AT503M Face Hex Nut, AT506M Locking Ring, AT508 Lockwasher, AT527M Backup Hex Nut. See Accessories & Hardware section. Optional Splashproof Boot Assemblies: AT401 & AT4181 boots plus hex nut & o-ring. See Accessories & Hardware section.

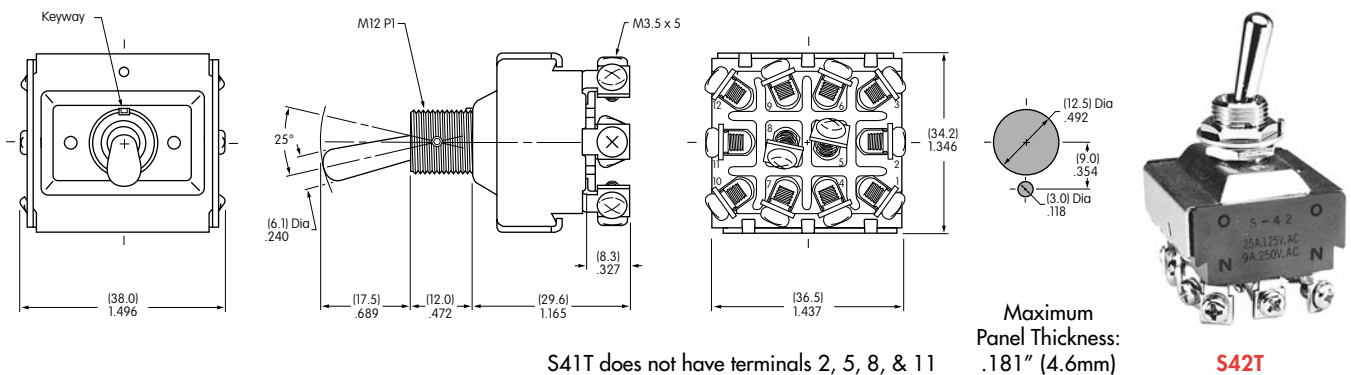

S41T does not have terminals 2, 5, 8, & 11

Toggles **A**

THREE POLE WITH QUICK CONNECT

| * UL, cULus & CSA recognized only when ordered with marking on switch (see General Specs) | | | | Toggle Position/Connected Terminals | | | | | Electrical Capacity | | | |
|---|-------------|---|---|-------------------------------------|----------------|--------|----------------|-----------|---------------------|--------|----------------|------------------------------|
| Model | * Approvals | | | Pole & Throw | Down | Center | Up | Resistive | | | Inductive | $\alpha =$ Angle of Throw |
| | | | | | | | | AC 125V | AC 250V | DC 30V | AC 125V PF 0.6 | |
| S31F | ✓ | ✓ | ✓ | 3PST | ON 1-3 4-6 7-9 | NONE | OFF | 25A | 9A | 20A | 10A | 25° |
| S32F | ✓ | ✓ | ✓ | 3PDT | ON 2-3 5-6 8-9 | NONE | ON 2-1 5-4 8-7 | 25A | 9A | 20A | 10A | 25° |
| S33F | ✓ | ✓ | ✓ | 3PDT | ON 2-3 5-6 8-9 | OFF | ON 2-1 5-4 8-7 | 25A | 9A | 20A | 10A | 30° |

Throw & Schematics:



Note: Terminal numbers are on the switch

Notes: Standard Hardware: AT503M Face Hex Nut, AT506M Locking Ring, AT508 Lockwasher, AT527M Backup Hex Nut. See Accessories & Hardware section. Optional Splashproof Boot Assemblies: AT401 & AT4181 boots plus hex nut & o-ring. See Accessories & Hardware section.



S32F

S31F does not have terminals 2, 5, & 8

Maximum Panel Thickness: .181" (4.6mm)

FOUR POLE WITH QUICK CONNECT

| * UL, cULus & CSA recognized only when ordered with marking on switch (see General Specs) | | | | Toggle Position/Connected Terminals | | | | | Electrical Capacity | | | |
|---|-------------|---|---|-------------------------------------|----------------------|--------|----------------------|-----------|---------------------|--------|----------------|------------------------------|
| Model | * Approvals | | | Pole & Throw | Down | Center | Up | Resistive | | | Inductive | $\alpha =$ Angle of Throw |
| | | | | | | | | AC 125V | AC 250V | DC 30V | AC 125V PF 0.6 | |
| S41F | ✓ | ✓ | ✓ | 4PST | ON 1-3 4-6 7-9 10-12 | NONE | OFF | 25A | 9A | 20A | 10A | 25° |
| S42F | ✓ | ✓ | ✓ | 4PDT | ON 2-3 5-6 8-9 11-12 | NONE | ON 2-1 5-4 8-7 11-10 | 25A | 9A | 20A | 10A | 25° |
| S43F | ✓ | ✓ | ✓ | 4PDT | ON 2-3 5-6 8-9 11-12 | OFF | ON 2-1 5-4 8-7 11-10 | 25A | 9A | 20A | 10A | 30° |

Throw & Schematics:



Note: Terminal numbers are on the switch

Notes: Standard Hardware: AT503M Face Hex Nut, AT506M Locking Ring, AT508 Lockwasher, AT527M Backup Hex Nut. See Accessories & Hardware section. Optional Splashproof Boot Assemblies: AT401 & AT4181 boots plus hex nut & o-ring. See Accessories & Hardware section.

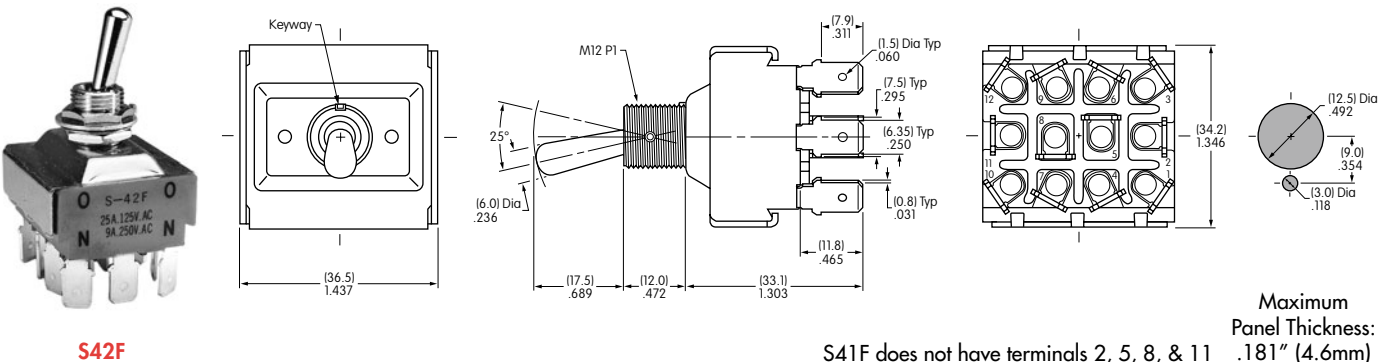

S42F

S41F does not have terminals 2, 5, 8, & 11

Maximum Panel Thickness: .181" (4.6mm)

Rockers

Pushbuttons

Illuminated PB

Programmable

Keylocks

Rotaries

Slides

Tactiles

Tilt

Touch

Indicators

Accessories

Supplement

GENERAL SPECIFICATIONS FOR S421 ~ S429

Electrical Capacity (Resistive & Inductive Load)

Power Level: Shown in the following tables

Other Ratings

Contact Resistance: 10 milliohms maximum
Insulation Resistance: 1,000 megohms minimum @ 500V DC
Dielectric Strength: 2,000V AC minimum for 1 minute minimum
Mechanical Life: 50,000 operations minimum
Electrical Life: 15,000 operations minimum
Angle of Throw (α): Shown in tables on following pages

Materials & Finishes

Toggle: Brass with chrome plating
Bushing: Brass with chrome plating
Case: Melamine phenol
Case Cover: Steel with chromate plating over zinc plating
Movable Contactor: Copper with silver plating
Movable Contacts: Silver alloy capped on copper with silver plating
Stationary Contacts: Silver alloy capped on copper with silver plating
Terminals: Brass with tin plating

Environmental Data

Operating Temp Range: -10°C through +70°C (+14°F through +158°F)

Installation

Mounting Torque: 2.94Nm (26 lb·in) for double nut
Maximum Panel Thickness: Shown beneath panel cutout in switch dimension drawings
Soldering Time & Temperature: Manual Soldering: See Profile A in Supplement section.

A
Toggles

Rockers

Pushbuttons

Illuminated PB

Programmable

Keylocks

Rotaries

Slides

Tactiles

Tilt

Touch

Indicators

Accessories

Supplement

Toggles
A

DOUBLE POLE WITH SOLDER LUG *

| Model | Approvals | | Pole & Throw | Toggle Position/Connected Terminals () = Momentary | | | | | | Electrical Capacity | | | | Motor Load AC 125V | α = Angle of Throw |
|-------|-----------|-----|--------------|---|---|---|-----------|---------|--------------------------|---------------------|-----|-----|------|-----------------------|--------------------|
| | UL | CSA | | Down  | Center  | Up  | Resistive | | Inductive | | | | | | |
| | | | | | | | AC 125V | AC 250V | PF 0.75 - 0.8 AC 125V | AC 250V | | | | | |
| S421 | — | — | DPST | ON | 1-3 4-6 | NONE | OFF | — | 25A | 25A | 25A | 25A | 750W | 24° | |
| S422 | — | — | DPDT | ON | 2-3 5-6 | NONE | ON | 2-1 5-4 | 25A | 25A | 25A | 25A | 750W | 24° | |
| S423 | — | — | DPDT | ON | 2-3 5-6 | OFF | ON | 2-1 5-4 | 25A | 25A | 25A | 25A | 750W | 28° | |
| S425 | — | — | DPDT | ON | 2-3 5-6 | NONE | (ON) | 2-1 5-4 | 15A | 15A | 15A | 15A | 400W | 24° | |
| S428 | — | — | DPDT | (ON) | 2-3 5-6 | OFF | (ON) | 2-1 5-4 | 15A | 15A | 15A | 15A | 400W | 24° | |
| S429 | — | — | DPDT | ON | 2-3 5-6 | OFF | (ON) | 2-1 5-4 | 15A | 15A | 15A | 15A | 400W | 24° | |

Throw & Schematics: DPST  INTERNAL CONNECTION  Note: Terminal numbers are on the switch

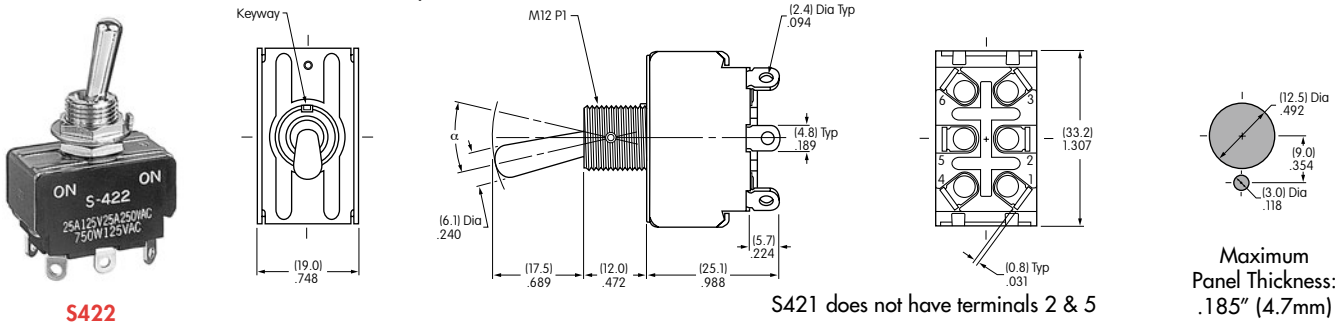

Notes: Standard Hardware: AT503M Face Hex Nut, AT506M Locking Ring, AT508 Lockwasher, AT527M Backup Hex Nut. See Accessories & Hardware section.
Optional Splashproof Boot Assemblies: AT401 & AT4181 boots plus hex nut & o-ring. See Accessories & Hardware section.

* Wire harness & cable assemblies offered only in Americas.



S422

DOUBLE POLE WITH SCREW LUG

| Model | Approvals | | Pole & Throw | Toggle Position/Connected Terminals () = Momentary | | | | | | Electrical Capacity | | | | Motor Load AC 125V | α = Angle of Throw |
|-------|-----------|-----|--------------|---|---|---|-----------|---------|--------------------------|---------------------|-----|-----|------|-----------------------|--------------------|
| | UL | CSA | | Down  | Center  | Up  | Resistive | | Inductive | | | | | | |
| | | | | | | | AC 125V | AC 250V | PF 0.75 - 0.8 AC 125V | AC 250V | | | | | |
| S421T | — | — | DPST | ON | 1-3 4-6 | NONE | OFF | — | 20A | 20A | 20A | 20A | 750W | 24° | |
| S422T | — | — | DPDT | ON | 2-3 5-6 | NONE | ON | 2-1 5-4 | 20A | 20A | 20A | 20A | 750W | 24° | |
| S423T | — | — | DPDT | ON | 2-3 5-6 | OFF | ON | 2-1 5-4 | 20A | 20A | 20A | 20A | 750W | 28° | |
| S425T | — | — | DPDT | ON | 2-3 5-6 | NONE | (ON) | 2-1 5-4 | 15A | 15A | 15A | 15A | 400W | 24° | |
| S428T | — | — | DPDT | (ON) | 2-3 5-6 | OFF | (ON) | 2-1 5-4 | 15A | 15A | 15A | 15A | 400W | 24° | |
| S429T | — | — | DPDT | ON | 2-3 5-6 | OFF | (ON) | 2-1 5-4 | 15A | 15A | 15A | 15A | 400W | 24° | |

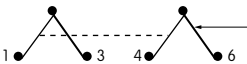
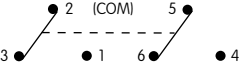
Throw & Schematics: DPST  INTERNAL CONNECTION  Note: Terminal numbers are on the switch

Notes: Standard Hardware: AT503M Face Hex Nut, AT506M Locking Ring, AT508 Lockwasher, AT527M Backup Hex Nut. See Accessories & Hardware section.
Optional Splashproof Boot Assemblies: AT401 & AT4181 boots plus hex nut & o-ring. See Accessories & Hardware section.

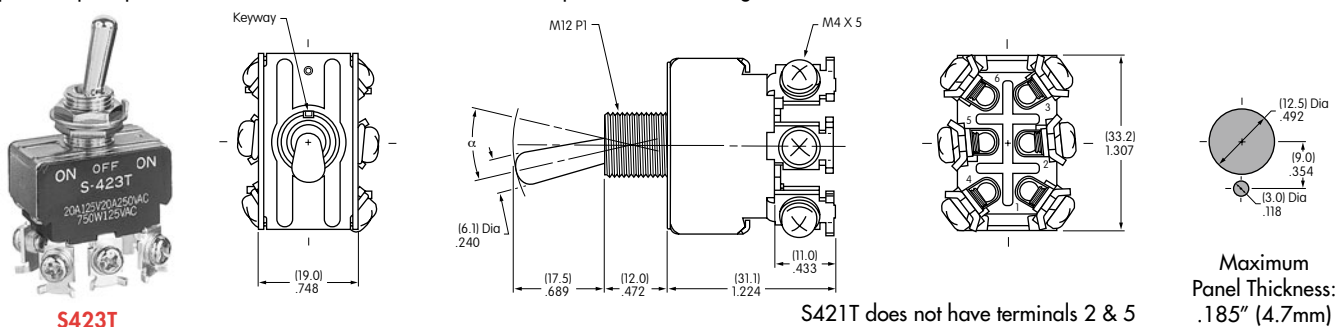

S423T

Rockers

Pushbuttons

Illuminated PB

Programmable

Keylocks

Rotaries

Slides

Tactiles

Tilt

Touch

Indicators

Accessories

Supplement

Компания «Океан Электроники» предлагает заключение долгосрочных отношений при поставках импортных электронных компонентов на взаимовыгодных условиях!

Наши преимущества:

- Поставка оригинальных импортных электронных компонентов напрямую с производств Америки, Европы и Азии, а так же с крупнейших складов мира;
- Широкая линейка поставок активных и пассивных импортных электронных компонентов (более 30 млн. наименований);
- Поставка сложных, дефицитных, либо снятых с производства позиций;
- Оперативные сроки поставки под заказ (от 5 рабочих дней);
- Экспресс доставка в любую точку России;
- Помощь Конструкторского Отдела и консультации квалифицированных инженеров;
- Техническая поддержка проекта, помощь в подборе аналогов, поставка прототипов;
- Поставка электронных компонентов под контролем ВП;
- Система менеджмента качества сертифицирована по Международному стандарту ISO 9001;
- При необходимости вся продукция военного и аэрокосмического назначения проходит испытания и сертификацию в лаборатории (по согласованию с заказчиком);
- Поставка специализированных компонентов военного и аэрокосмического уровня качества (Xilinx, Altera, Analog Devices, Intersil, Interpoint, Microsemi, Actel, Aeroflex, Peregrine, VPT, Syfer, Eurofarad, Texas Instruments, MS Kennedy, Miteq, Cobham, E2V, MA-COM, Hittite, Mini-Circuits, General Dynamics и др.);

Компания «Океан Электроники» является официальным дистрибьютором и эксклюзивным представителем в России одного из крупнейших производителей разъемов военного и аэрокосмического назначения «JONHON», а так же официальным дистрибьютором и эксклюзивным представителем в России производителя высокотехнологичных и надежных решений для передачи СВЧ сигналов «FORSTAR».



JONHON

«JONHON» (основан в 1970 г.)

Разъемы специального, военного и аэрокосмического назначения:

(Применяются в военной, авиационной, аэрокосмической, морской, железнодорожной, горно- и нефтедобывающей отраслях промышленности)

«FORSTAR» (основан в 1998 г.)

ВЧ соединители, коаксиальные кабели, кабельные сборки и микроволновые компоненты:

(Применяются в телекоммуникациях гражданского и специального назначения, в средствах связи, РЛС, а так же военной, авиационной и аэрокосмической отраслях промышленности).



Телефон: 8 (812) 309-75-97 (многоканальный)

Факс: 8 (812) 320-03-32

Электронная почта: ocean@oceanchips.ru

Web: <http://oceanchips.ru/>

Адрес: 198099, г. Санкт-Петербург, ул. Калинина, д. 2, корп. 4, лит. А