

GENERAL SPECIFICATIONS FOR S301 ~ S339

Toggles
A

Rockers

Pushbuttons

Illuminated PB

Programmable

Keylocks

Rotaries

Slides

Tactiles

Tilt

Touch

Indicators

Accessories

Supplement

Electrical Capacity (Resistive & Inductive Load)

Power Level: Shown in the following tables

Other Ratings

Contact Resistance:	10 milliohms maximum
Insulation Resistance:	1,000 megohms minimum @ 500V DC
Dielectric Strength:	2,000V AC minimum for 1 minute minimum
Mechanical Life:	50,000 operations minimum
Electrical Life:	6,000 operations minimum for S331F; 15,000 operations minimum for all other S331s; 25,000 operations minimum for all others
Angle of Throw (α):	Shown on following tables

Materials & Finishes

Toggle:	PBT for flatted lever; brass with chrome plating for all others
Bushing:	Brass with chrome plating
Case:	Melamine phenol
Case Cover:	Steel with zinc plating
Movable Contactor:	Copper with silver plating
Movable & Stationary Contacts:	Silver alloy capped on copper with silver plating
Terminals:	Brass with tin plating

Environmental Data

Operating Temperature Range: $-10^{\circ}\text{C} \sim +70^{\circ}\text{C}$ ($+14^{\circ}\text{F} \sim +158^{\circ}\text{F}$)

Installation

Mounting Torque: 2.94Nm (26 lb•in) for double nut; 1.47Nm (13 lb•in) for single nut
Soldering Time & Temperature: Manual Soldering: See Profile A in Supplement section.

Standards & Certifications

- UL:** File No. E44145 - Recognized only when ordered with marking on switch. Add "/U" or "/CUL" to end of part number to order UL recognized switch. UL or cULus recognition designated beside part numbers on following pages. See Supplement section to find UL or cULus rating details.
- CSA:** File No. 023535_0_000 - Certified only when ordered with marking on switch. Add "/C" to end of part number to order CSA certified switch. CSA certification designated beside part numbers on following pages. See Supplement section to find CSA rating details

SINGLE POLE WITH SOLDER LUG *

* UL, cULus & CSA recognized only when ordered with marking on switch (see General Specs)			Toggle Position/Connected Terminals () = Momentary						Electrical Capacity			
Model	* Approvals			Pole & Throw	Down Keyway	Center	Up	Resistive			Inductive AC 125V PF 0.6	Angle of Throw
	UL	cULus	CSA					AC 125V	AC 250V	DC 30V		
S301	✓	✓	✓	SPST	ON 1-3	NONE	OFF —	15A	6A	20A	10A	32°
S302	✓	✓	✓	SPDT	ON 2-3	NONE	ON 2-1	15A	6A	20A	10A	32°
S303	✓	✓	✓	SPDT	ON 2-3	OFF	ON 2-1	15A	6A	20A	10A	32°
S305	—	—	✓	SPDT	ON 2-3	NONE	(ON) 2-1	15A	6A	20A	8A	32°
S308	—	—	✓	SPDT	(ON) 2-3	OFF	(ON) 2-1	15A	6A	20A	8A	32°
S309	—	—	✓	SPDT	ON 2-3	OFF	(ON) 2-1	15A	6A	20A	8A	32°

Throw & Schematics: SPST INTERNAL CONNECTION SPDT

Note: Terminal numbers are actually on the switch

Notes: Standard Hardware: AT503M Face Hex Nut, AT506M Locking Ring, AT508 Lockwasher, AT527M Backup Hex Nut. See Accessories & Hardware section.
Optional Splashproof Boot Assemblies: AT401 & AT4181 boots plus hex nut & o-ring. See Accessories & Hardware section.

* Wire harness & cable assemblies offered only in Americas.



DOUBLE POLE WITH SOLDER LUG *

* UL, cULus & CSA recognized only when ordered with marking on switch (see General Specs)			Toggle Position/Connected Terminals () = Momentary						Electrical Capacity			
Model	* Approvals			Pole & Throw	Down Keyway	Center	Up	Resistive			Inductive AC 125V PF 0.6	α = Angle of Throw
	UL	cULus	CSA					AC 125V	AC 250V	DC 30V		
S331	✓	✓	✓	DPST	ON 1-3 4-6	NONE	OFF —	25A	25A	25A	10A	25°
S332	✓	✓	✓	DPDT	ON 2-3 5-6	NONE	ON 2-1 5-4	25A	15A	25A	10A	25°
S333	✓	✓	✓	DPDT	ON 2-3 5-6	OFF	ON 2-1 5-4	25A	15A	25A	10A	30°
S335	✓	✓	✓	DPDT	ON 2-3 5-6	NONE	(ON) 2-1 5-4	15A	6A	20A	8A	25°
S338	✓	✓	—	DPDT	(ON) 2-3 5-6	OFF	(ON) 2-1 5-4	15A	6A	20A	8A	25°
S339	✓	✓	—	DPDT	ON 2-3 5-6	OFF	(ON) 2-1 5-4	15A	6A	20A	8A	25°

Throw & Schematics: DPST INTERNAL CONNECTION DPDT

Note: Terminal numbers are actually on the switch

Notes: Standard Hardware: AT503M Face Hex Nut, AT506M Locking Ring, AT508 Lockwasher, AT527M Backup Hex Nut. See Accessories & Hardware section.
Optional Splashproof Boot Assemblies: AT401 & AT4181 boots plus hex nut & o-ring. See Accessories & Hardware section.

* Wire harness & cable assemblies offered only in Americas.



DOUBLE POLE WITH SOLDER LUG & FLATTED LEVER *

Model	* Approvals			Pole & Throw	Toggle Position/Connected Terminals () = Momentary					Electrical Capacity				α = Angle of Throw
	UL	cULus	CS		Down 	Center 	Up 	Resistive			Inductive			
								AC 125V	AC 250V	DC 30V	AC 125V PF 0.6			
S331R	✓	✓	—	DPST	ON 1-3 4-6	NONE	OFF —	25A	25A	25A	10A	25°		
S332R	✓	✓	—	DPDT	2-3 5-6	NONE	ON 2-1 5-4	25A	15A	25A	10A	25°		
S333R	✓	✓	—	DPDT	ON 2-3 5-6	OFF	ON 2-1 5-4	25A	15A	25A	10A	30°		
S338R	✓	✓	—	DPDT	(ON) 2-3 5-6	OFF	(ON) 2-1 5-4	15A	6A	20A	8A	25°		
S339R	✓	✓	—	DPDT	ON 2-3 5-6	OFF	(ON) 2-1 5-4	15A	6A	20A	8A	25°		

Throw & Schematics:



Note: Terminal numbers are actually on the switch

Notes: Standard Hardware: AT504M Knurled Nut, AT508 Lockwasher, AT527M Backup Hex Nut. See Accessories & Hardware section.

* Wire harness & cable assemblies offered only in Americas.



S331R

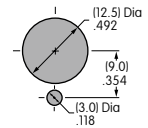
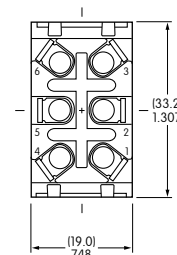
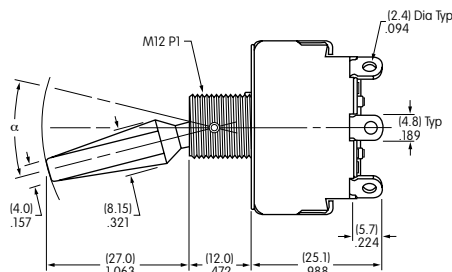
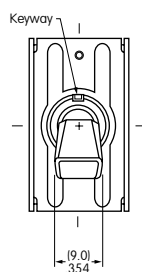

S331R does not have terminals 2 & 5

Maximum Panel Thickness: .220" (5.6mm)

SINGLE POLE WITH SCREW LUG

* UL, cULus & CSA recognized only when ordered with marking on switch (see General Specs)			Toggle Position/Connected Terminals () = Momentary					Electrical Capacity				α = Angle of Throw
Model	* Approvals			Pole & Throw	Down 	Center 	Up 	Resistive			Inductive	
	UL	cULus	CSA					AC 125V	AC 250V	DC 30V	AC 125V PF 0.6	
S301T	✓	✓	✓	SPST	ON 1-3	NONE	OFF —	15A	6A	20A	10A	32°
S302T	✓	✓	✓	SPDT	ON 2-3	NONE	ON 2-1	15A	6A	20A	10A	32°
S303T	✓	✓	✓	SPDT	ON 2-3	OFF	ON 2-1	15A	6A	20A	10A	32°
S305T	—	—	✓	SPDT	ON 2-3	NONE	(ON) 2-1	15A	6A	20A	8A	32°
S308T	—	—	✓	SPDT	(ON) 2-3	OFF	(ON) 2-1	15A	6A	20A	8A	32°
S309T	—	—	✓	SPDT	ON 2-3	OFF	(ON) 2-1	15A	6A	20A	8A	32°

Throw & Schematics: SPST  INTERNAL CONNECTION  Note: Terminal numbers are actually on the switch

Notes: Standard Hardware: AT503M Face Hex Nut, AT506M Locking Ring, AT508 Lockwasher, AT527M Backup Hex Nut. See Accessories & Hardware section. Optional Splashproof Boot Assemblies: AT401 & AT4181 boots plus hex nut & o-ring. See Accessories & Hardware section.

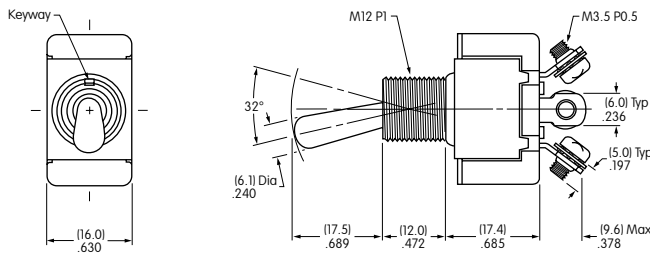

S301T does not have terminal 2



Maximum Panel Thickness: .185" (4.7mm)



S301T

DOUBLE POLE WITH SCREW LUG

* UL & cULus recognized only when ordered with marking on switch (see General Specs)			Toggle Position/Connected Terminals () = Momentary					Electrical Capacity				α = Angle of Throw
Model	* Approvals			Pole & Throw	Down 	Center 	Up 	Resistive			Inductive	
	UL	cULus	CSA					AC 125V	AC 250V	DC 30V	AC 125V PF 0.6	
S331T	✓	✓	—	DPST	ON 1-3 4-6	NONE	OFF —	15A	15A	15A	10A	25°
S332T	✓	✓	—	DPDT	ON 2-3 5-6	NONE	ON 2-1 5-4	15A	15A	15A	10A	25°
S333T	✓	✓	—	DPDT	ON 2-3 5-6	OFF	ON 2-1 5-4	15A	15A	15A	10A	30°
S335T	✓	✓	—	DPDT	ON 2-3 5-6	NONE	(ON) 2-1 5-4	15A	6A	20A	8A	25°
S338T	✓	✓	—	DPDT	(ON) 2-3 5-6	OFF	(ON) 2-1 5-4	15A	6A	20A	8A	25°
S339T	✓	✓	—	DPDT	ON 2-3 5-6	OFF	(ON) 2-1 5-4	15A	6A	20A	8A	25°

Throw & Schematics: DPST  INTERNAL CONNECTION  Note: Terminal numbers are actually on the switch

Notes: Standard Hardware: AT503M Face Hex Nut, AT506M Locking Ring, AT508 Lockwasher, AT527M Backup Hex Nut. See Accessories & Hardware section. Optional Splashproof Boot Assemblies: AT401 & AT4181 boots plus hex nut & o-ring. See Accessories & Hardware section.

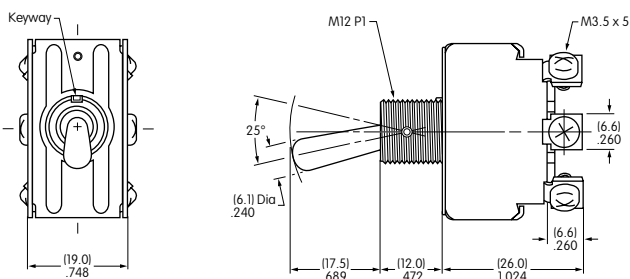

S331T does not have terminals 2 & 5



Maximum Panel Thickness: .185" (4.7mm)



S331T

Toggles **A**

Rockers

Pushbuttons

Illuminated PB

Programmable

Keylocks

Rotaries

Slides

Tactiles

Tilt



Touch

Indicators

Accessories

Supplement

SINGLE POLE WITH QUICK CONNECT

* UL, cULus & CSA recognized only when ordered with marking on switch (see General Specs)			Toggle Position/Connected Terminals				Electrical Capacity				α = Angle of Throw	
Model	* Approvals			Pole & Throw	Down 	Center 	Up 	Resistive				Inductive
	UL	cULus	CSA					AC 125V	AC 250V	DC 30V		AC 125V PF 0.6
S301F	✓	✓	✓	SPST	ON 1-3	NONE	OFF —	15A	6A	20A	10A	32°

Throw & Schematics: SPST  INTERNAL CONNECTION

Note: Terminal numbers are actually on the switch

Notes: Standard Hardware: AT503M Face Hex Nut, AT506M Locking Ring, AT508 Lockwasher, AT527M Backup Hex Nut. See Accessories & Hardware section. Optional Splashproof Boot Assemblies: AT401 & AT4181 boots plus hex nut & o-ring. See Accessories & Hardware section.







S301F



Maximum Panel Thickness: .185" (4.7mm)

DOUBLE POLE WITH QUICK CONNECT

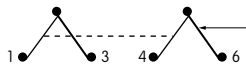
* UL & cULus recognized only when ordered with marking on switch (see General Specs)			Toggle Position/Connected Terminals () = Momentary				Electrical Capacity				α = Angle of Throw	
Model	* Approvals			Pole & Throw	Down 	Center 	Up 	Resistive				Inductive
	UL	cULus	CSA					AC 125V	AC 250V	DC 30V		AC 125V PF 0.6
S331F	✓	✓	—	DPST	ON 1-3 4-6	NONE	OFF —	25A	25A	25A	10A	25°
S332F	✓	✓	—	DPDT	ON 2-3 5-6	NONE	ON 2-1 5-4	25A	15A	25A	10A	25°
S333F	✓	✓	—	DPDT	ON 2-3 5-6	OFF	ON 2-1 5-4	25A	15A	25A	10A	30°
S335F	✓	✓	—	DPDT	ON 2-3 5-6	NONE	(ON) 2-1 5-4	15A	6A	20A	8A	25°

Throw & Schematics: DPST  INTERNAL CONNECTION DPDT 

Note: Terminal numbers are actually on the switch

Notes: Standard Hardware: AT503M Face Hex Nut, AT506M Locking Ring, AT508 Lockwasher, AT527M Backup Hex Nut. See Accessories & Hardware section. Optional Splashproof Boot Assemblies: AT401 & AT4181 boots plus hex nut & o-ring. See Accessories & Hardware section.



S332F

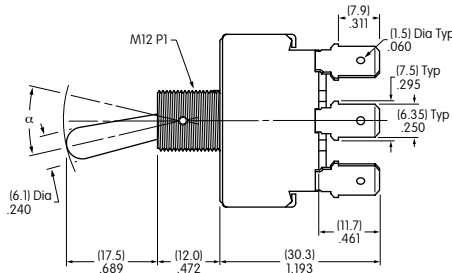

Maximum Panel Thickness: .185" (4.7mm)

S331F does not have terminals 2 & 5

GENERAL SPECIFICATIONS FOR S31 ~ S49

Electrical Capacity (Resistive & Inductive Load)

Power Level: Shown in the following tables

Other Ratings

Contact Resistance: 10 milliohms maximum
Insulation Resistance: 1,000 megohms minimum @ 500V DC
Dielectric Strength: 2,000V AC minimum for 1 minute minimum
Mechanical Life: 50,000 operations minimum
Electrical Life: 25,000 operations minimum
Angle of Throw (α): Shown on following tables

Materials & Finishes

Toggle: PBT resin for flatted lever; brass with chrome plating for all others
Bushing: Brass with chrome plating
Case: Phenolic resin
Case Cover: Steel with chromate plating over zinc plating
Movable Contact: Copper with silver plating
Movable Contacts: Silver alloy capped on copper with silver plating
Stationary Contacts: Silver alloy capped on copper with silver plating
Terminals: Brass with tin plating

Environmental Data

Operating Temp Range: -10°C through +70°C (+14°F through +158°F)

Installation

Mounting Torque: 2.94Nm (26 lb•in) for double nut
Maximum Panel Thickness: Shown beneath panel cutout in switch dimension drawings
Soldering Time & Temperature: Manual Soldering: See Profile A in Supplement section.

Standards & Certifications

UL: File No. E44145 - Recognized only when ordered with marking on switch.
 Add "/U" or "/CUL" to end of part number to order UL recognized switch.
 UL or cULus recognition designated beside part numbers on following pages.
 See Supplement section to find UL or cULus rating details.

CSA: File No. 023535_0_000 - Certified only when ordered with marking on switch.
 Add "/C" to end of part number to order CSA certified switch.
 CSA certification designated beside part numbers on following pages.
 See Supplement section to find CSA rating details.

A
Toggles

Rockers

Pushbuttons

Illuminated PB

Programmable

Keylocks

Rotaries

Slides

Tactiles

Tilt

Touch

Indicators

Accessories

Supplement

Toggles **A**

THREE POLE WITH SOLDER LUG *

Model	* Approvals			Pole & Throw	Toggle Position/Connected Terminals () = Momentary						Electrical Capacity				α = Angle of Throw
	UL	cULus	CSA		Down Keyway	Center	Up	Resistive			Inductive AC 125V PF 0.6				
								AC 125V	AC 250V	DC 30V					
S31	✓	✓	✓	3PST	ON	1-3 4-6 7-9	NONE	OFF	—	25A	9A	20A	10A	25°	
S32	✓	✓	✓	3PDT	ON	2-3 5-6 8-9	NONE	ON	2-1 5-4 8-7	25A	9A	20A	10A	25°	
S33	✓	✓	✓	3PDT	ON	2-3 5-6 8-9	OFF	ON	2-1 5-4 8-7	25A	9A	20A	10A	30°	
S35	✓	✓	✓	3PDT	ON	2-3 5-6 8-9	NONE	(ON)	2-1 5-4 8-7	15A	6A	20A	8A	25°	
S38	✓	✓	✓	3PDT	(ON)	2-3 5-6 8-9	OFF	(ON)	2-1 5-4 8-7	15A	6A	15A	8A	25°	
S39	✓	✓	✓	3PDT	ON	2-3 5-6 8-9	OFF	(ON)	2-1 5-4 8-7	15A	6A	15A	8A	25°	



Notes: Standard Hardware: AT503M Face Hex Nut, AT506M Locking Ring, AT508 Lockwasher, AT527M Backup Hex Nut. See Accessories & Hardware section. Optional Splashproof Boot Assemblies: AT401 & AT4181 boots plus hex nut & o-ring. See Accessories & Hardware section.

* Wire harness & cable assemblies offered only in Americas.

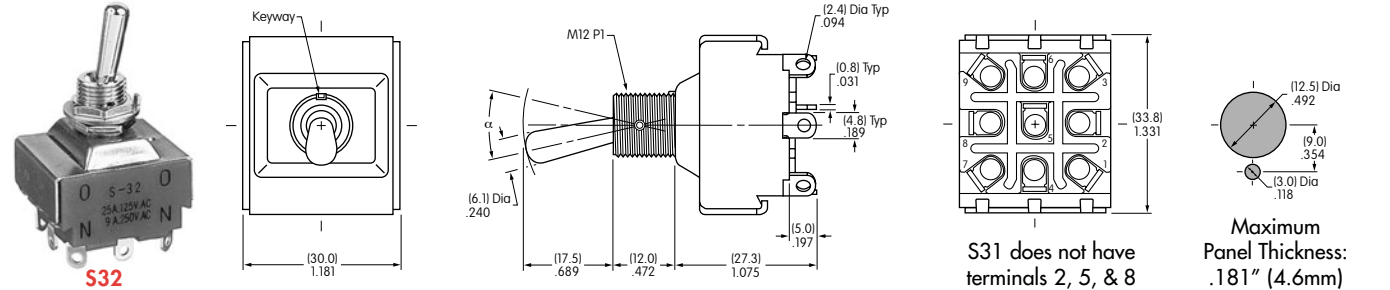

FOUR POLE WITH SOLDER LUG *

Model Suffix R = Flatted Lever	* Approvals			Pole & Throw	Toggle Position/Connected Terminals () = Momentary						Electrical Capacity				α = Angle of Throw
	UL	cULus	CSA		Down Keyway	Center	Up	Resistive			Inductive AC 125V PF 0.6				
								AC 125V	AC 250V	DC 30V					
S41/S41R	✓	✓	✓	4PST	ON	1-3 4-6 7-9 10-12	NONE	OFF	—	25A	9A	20A	10A	25°	
S42/S42R	✓	✓	✓	4PDT	ON	2-3 5-6 8-9 11-12	NONE	ON	2-1 5-4 8-7 11-10	25A	9A	20A	10A	25°	
S43/S43R	✓	✓	✓	4PDT	ON	2-3 5-6 8-9 11-12	OFF	ON	2-1 5-4 8-7 11-10	25A	9A	20A	10A	30°	
S45	—	✓	—	4PDT	ON	2-3 5-6 8-9 11-12	NONE	(ON)	2-1 5-4 8-7 11-10	15A	6A	20A	8A	25°	
S48/S48R	✓	✓	—	4PDT	(ON)	2-3 5-6 8-9 11-12	OFF	(ON)	2-1 5-4 8-7 11-10	15A	6A	20A	8A	25°	
S49/S49R	✓	✓	—	4PDT	ON	2-3 5-6 8-9 11-12	OFF	(ON)	2-1 5-4 8-7 11-10	15A	6A	20A	8A	25°	



Notes: Standard Hardware for **Bat Lever**: AT503M Face Hex Nut, AT506M Locking Ring, AT508 Lockwasher, AT527M Backup Hex Nut; for **Flatted Lever (R)**: AT504M Knurled Face Nut, AT508 Lockwasher, AT527M Backup Hex Nut. See Accessories & Hardware section.

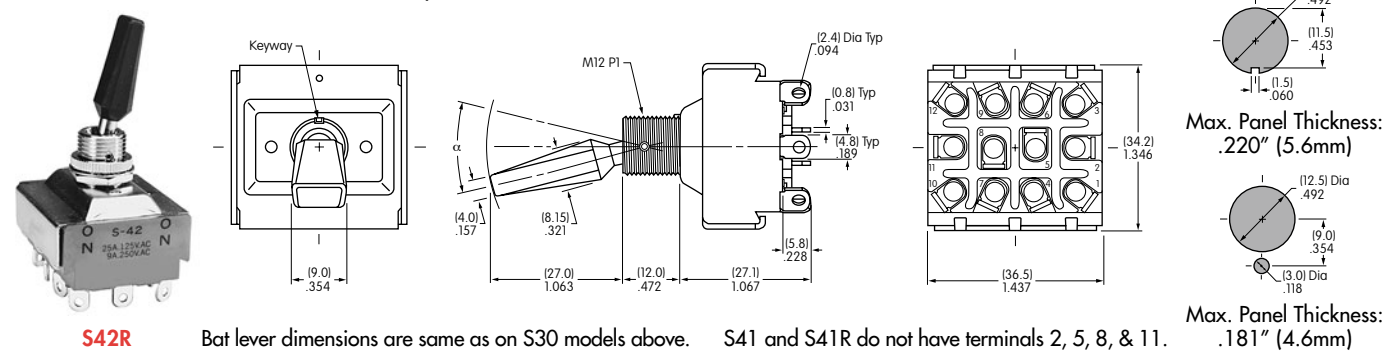

Optional Splashproof Boot Assemblies (only for bat lever models): AT401 & AT4181 boots plus hex nut and o-ring. See Accessories & Hardware section.

* Wire harness & cable assemblies offered only in Americas.



Rockers
 Pushbuttons
 Illuminated PB
 Programmable
 Keylocks
 Rotaries
 Slides
 Tactiles
 Tilt
 Touch
 Indicators
 Accessories
 Supplement

THREE POLE WITH SCREW LUG

* UL, cULus & CSA recognized only when ordered with marking on switch (see General Specs)			Toggle Position/Connected Terminals						Electrical Capacity					α = Angle of Throw
Model	* Approvals			Pole & Throw	Down 	Center 	Up 	Resistive			Inductive			
	UL	cULus	CSA					AC 125V	AC 250V	DC 30V	AC 125V PF 0.6	AC 250V PF 0.6		
S31T	✓	✓	✓	3PST	ON 1-3 4-6 7-9	NONE	OFF —	25A	9A	20A	10A	5A	25°	
S32T	✓	✓	✓	3PDT	ON 2-3 5-6 8-9	NONE	ON 2-1 5-4 8-7	25A	9A	20A	10A	5A	25°	
S33T	✓	✓	✓	3PDT	ON 2-3 5-6 8-9	OFF	ON 2-1 5-4 8-7	25A	9A	20A	10A	5A	30°	

Throw & Schematics:

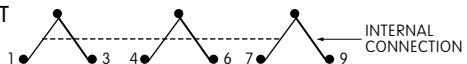
3PST:  INTERNAL CONNECTION

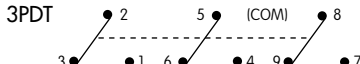

3PDT:  (COM) 8

Note: Terminal numbers are on the switch

Notes: Standard Hardware: AT503M Face Hex Nut, AT506M Locking Ring, AT508 Lockwasher, AT527M Backup Hex Nut. See Accessories & Hardware section. Optional Splashproof Boot Assemblies: AT401 & AT4181 boots plus hex nut & o-ring. See Accessories & Hardware section.



FOUR POLE WITH SCREW LUG

* UL, cULus & CSA recognized only when ordered with marking on switch (see General Specs)			Toggle Position/Connected Terminals						Electrical Capacity					α = Angle of Throw
Model	* Approvals			Pole & Throw	Down 	Center 	Up 	Resistive			Inductive			
	UL	cULus	CSA					AC 125V	AC 250V	DC 30V	AC 125V PF 0.6	AC 250V PF 0.6		
S41T	✓	✓	✓	4PST	ON 1-3 4-6 7-9 10-12	NONE	OFF —	25A	9A	20A	10A	5A	25°	
S42T	✓	✓	✓	4PDT	ON 2-3 5-6 8-9 11-12	NONE	ON 2-1 5-4 8-7 11-10	25A	9A	20A	10A	5A	25°	
S43T	✓	✓	✓	4PDT	ON 2-3 5-6 8-9 11-12	OFF	ON 2-1 5-4 8-7 11-10	25A	9A	20A	10A	5A	30°	

Throw & Schematics:

4PST:  INTERNAL CONNECTION

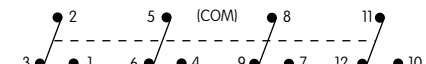
4PDT:  (COM) 8

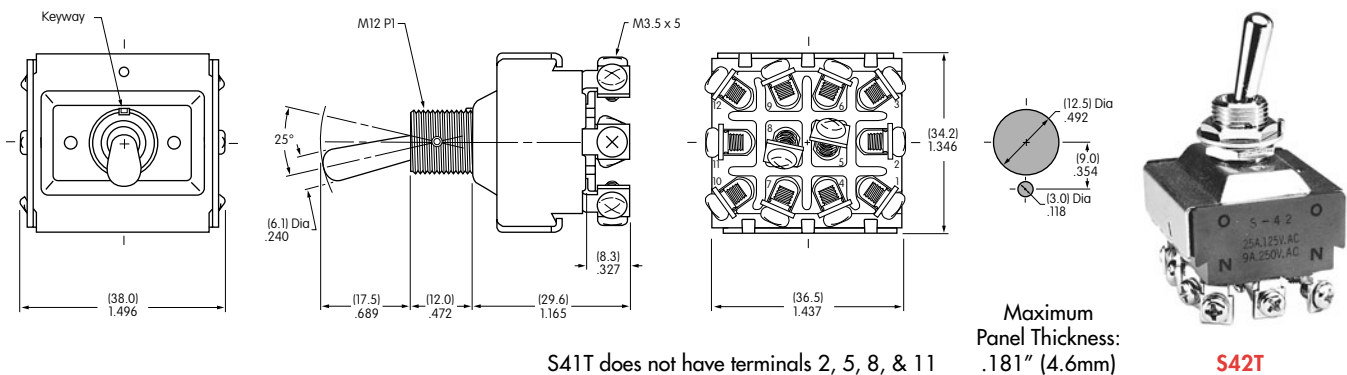

Note: Terminal numbers are on the switch

Notes: Standard Hardware: AT503M Face Hex Nut, AT506M Locking Ring, AT508 Lockwasher, AT527M Backup Hex Nut. See Accessories & Hardware section. Optional Splashproof Boot Assemblies: AT401 & AT4181 boots plus hex nut & o-ring. See Accessories & Hardware section.



Toggles
A

THREE POLE WITH QUICK CONNECT

* UL, cULus & CSA recognized only when ordered with marking on switch (see General Specs)				Toggle Position/Connected Terminals					Electrical Capacity				$\alpha =$ Angle of Throw
Model	* Approvals			Pole & Throw	Down 	Center 	Up 	Resistive			Inductive		
	UL	cULus	CSA					AC 125V	AC 250V	DC 30V	AC 125V PF 0.6		
S31F	✓	✓	✓	3PST	ON 1-3 4-6 7-9	NONE	OFF —	25A	9A	20A	10A	25°	
S32F	✓	✓	✓	3PDT	ON 2-3 5-6 8-9	NONE	ON 2-1 5-4 8-7	25A	9A	20A	10A	25°	
S33F	✓	✓	✓	3PDT	ON 2-3 5-6 8-9	OFF	ON 2-1 5-4 8-7	25A	9A	20A	10A	30°	

Throw & Schematics:

3PST  INTERNAL CONNECTION

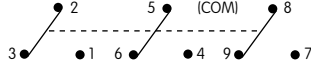

3PDT  (COM) 8

Note: Terminal numbers are on the switch

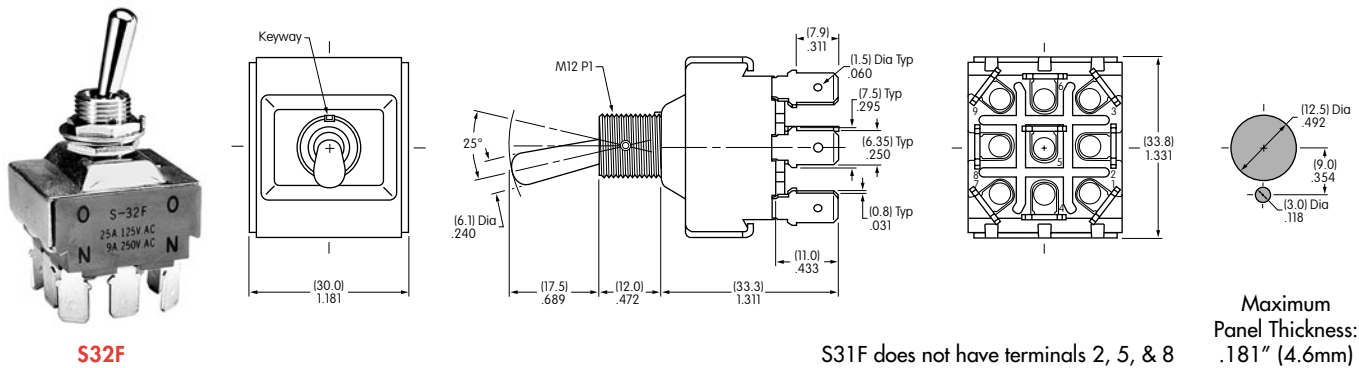
Notes: Standard Hardware: AT503M Face Hex Nut, AT506M Locking Ring, AT508 Lockwasher, AT527M Backup Hex Nut. See Accessories & Hardware section.
Optional Splashproof Boot Assemblies: AT401 & AT4181 boots plus hex nut & o-ring. See Accessories & Hardware section.



FOUR POLE WITH QUICK CONNECT

* UL, cULus & CSA recognized only when ordered with marking on switch (see General Specs)				Toggle Position/Connected Terminals					Electrical Capacity				$\alpha =$ Angle of Throw
Model	* Approvals			Pole & Throw	Down 	Center 	Up 	Resistive			Inductive		
	UL	cULus	CSA					AC 125V	AC 250V	DC 30V	AC 125V PF 0.6		
S41F	✓	✓	✓	4PST	ON 1-3 4-6 7-9 10-12	NONE	OFF —	25A	9A	20A	10A	25°	
S42F	✓	✓	✓	4PDT	ON 2-3 5-6 8-9 11-12	NONE	ON 2-1 5-4 8-7 11-10	25A	9A	20A	10A	25°	
S43F	✓	✓	✓	4PDT	ON 2-3 5-6 8-9 11-12	OFF	ON 2-1 5-4 8-7 11-10	25A	9A	20A	10A	30°	

Throw & Schematics:

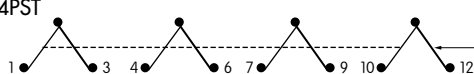
4PST  INTERNAL CONNECTION

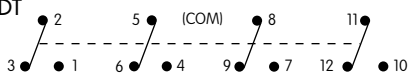
4PDT  (COM) 8

Note: Terminal numbers are on the switch

Notes: Standard Hardware: AT503M Face Hex Nut, AT506M Locking Ring, AT508 Lockwasher, AT527M Backup Hex Nut. See Accessories & Hardware section.
Optional Splashproof Boot Assemblies: AT401 & AT4181 boots plus hex nut & o-ring. See Accessories & Hardware section.

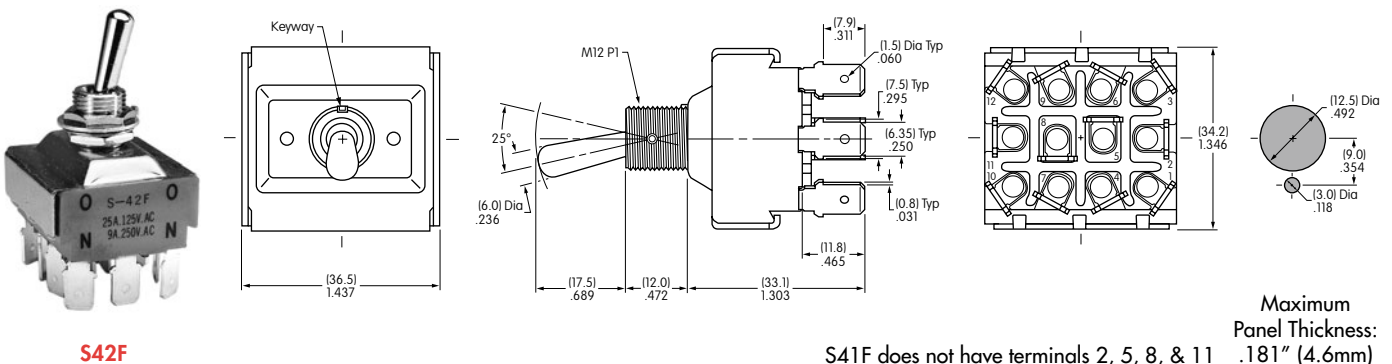

Rockers

Pushbuttons

Illuminated PB

Programmable

Keylocks

Rotaries

Slides

Tactiles

Tilt

Touch

Indicators

Accessories

Supplement

GENERAL SPECIFICATIONS FOR S421 ~ S429

Electrical Capacity (Resistive & Inductive Load)

Power Level: Shown in the following tables

Other Ratings

Contact Resistance: 10 milliohms maximum
Insulation Resistance: 1,000 megohms minimum @ 500V DC
Dielectric Strength: 2,000V AC minimum for 1 minute minimum
Mechanical Life: 50,000 operations minimum
Electrical Life: 15,000 operations minimum
Angle of Throw (α): Shown in tables on following pages

Materials & Finishes

Toggle: Brass with chrome plating
Bushing: Brass with chrome plating
Case: Melamine phenol
Case Cover: Steel with chromate plating over zinc plating
Movable Contactor: Copper with silver plating
Movable Contacts: Silver alloy capped on copper with silver plating
Stationary Contacts: Silver alloy capped on copper with silver plating
Terminals: Brass with tin plating

Environmental Data

Operating Temp Range: -10°C through +70°C (+14°F through +158°F)

Installation

Mounting Torque: 2.94Nm (26 lb·in) for double nut
Maximum Panel Thickness: Shown beneath panel cutout in switch dimension drawings
Soldering Time & Temperature: Manual Soldering: See Profile A in Supplement section.

A
Toggles

Rockers

Pushbuttons

Illuminated PB

Programmable

Keylocks

Rotaries

Slides

Tactiles

Tilt

Touch

Indicators

Accessories

Supplement

Toggles
A

DOUBLE POLE WITH SOLDER LUG *

Model	Approvals		Pole & Throw	Toggle Position/Connected Terminals () = Momentary						Electrical Capacity				Motor Load AC 125V	α = Angle of Throw
	UL	CSA		Down 	Center 	Up 	Resistive		Inductive						
							AC 125V	AC 250V	PF 0.75 - 0.8 AC 125V	AC 250V					
S421	—	—	DPST	ON	1-3 4-6	NONE	OFF	—	25A	25A	25A	25A	750W	24°	
S422	—	—	DPDT	ON	2-3 5-6	NONE	ON	2-1 5-4	25A	25A	25A	25A	750W	24°	
S423	—	—	DPDT	ON	2-3 5-6	OFF	ON	2-1 5-4	25A	25A	25A	25A	750W	28°	
S425	—	—	DPDT	ON	2-3 5-6	NONE	(ON)	2-1 5-4	15A	15A	15A	15A	400W	24°	
S428	—	—	DPDT	(ON)	2-3 5-6	OFF	(ON)	2-1 5-4	15A	15A	15A	15A	400W	24°	
S429	—	—	DPDT	ON	2-3 5-6	OFF	(ON)	2-1 5-4	15A	15A	15A	15A	400W	24°	

Throw & Schematics:



Note: Terminal numbers are on the switch

Notes: Standard Hardware: AT503M Face Hex Nut, AT506M Locking Ring, AT508 Lockwasher, AT527M Backup Hex Nut. See Accessories & Hardware section. Optional Splashproof Boot Assemblies: AT401 & AT4181 boots plus hex nut & o-ring. See Accessories & Hardware section.

* Wire harness & cable assemblies offered only in Americas.



S422



S421 does not have terminals 2 & 5



Maximum Panel Thickness: .185" (4.7mm)

DOUBLE POLE WITH SCREW LUG

Model	Approvals		Pole & Throw	Toggle Position/Connected Terminals () = Momentary						Electrical Capacity				Motor Load AC 125V	α = Angle of Throw
	UL	CSA		Down 	Center 	Up 	Resistive		Inductive						
							AC 125V	AC 250V	PF 0.75 - 0.8 AC 125V	AC 250V					
S421T	—	—	DPST	ON	1-3 4-6	NONE	OFF	—	20A	20A	20A	20A	750W	24°	
S422T	—	—	DPDT	ON	2-3 5-6	NONE	ON	2-1 5-4	20A	20A	20A	20A	750W	24°	
S423T	—	—	DPDT	ON	2-3 5-6	OFF	ON	2-1 5-4	20A	20A	20A	20A	750W	28°	
S425T	—	—	DPDT	ON	2-3 5-6	NONE	(ON)	2-1 5-4	15A	15A	15A	15A	400W	24°	
S428T	—	—	DPDT	(ON)	2-3 5-6	OFF	(ON)	2-1 5-4	15A	15A	15A	15A	400W	24°	
S429T	—	—	DPDT	ON	2-3 5-6	OFF	(ON)	2-1 5-4	15A	15A	15A	15A	400W	24°	

Throw & Schematics:



Note: Terminal numbers are on the switch

Notes: Standard Hardware: AT503M Face Hex Nut, AT506M Locking Ring, AT508 Lockwasher, AT527M Backup Hex Nut. See Accessories & Hardware section. Optional Splashproof Boot Assemblies: AT401 & AT4181 boots plus hex nut & o-ring. See Accessories & Hardware section.



S423T



S421T does not have terminals 2 & 5

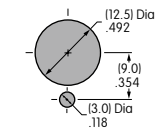

Maximum Panel Thickness: .185" (4.7mm)

Компания «Океан Электроники» предлагает заключение долгосрочных отношений при поставках импортных электронных компонентов на взаимовыгодных условиях!

Наши преимущества:

- Поставка оригинальных импортных электронных компонентов напрямую с производств Америки, Европы и Азии, а так же с крупнейших складов мира;
- Широкая линейка поставок активных и пассивных импортных электронных компонентов (более 30 млн. наименований);
- Поставка сложных, дефицитных, либо снятых с производства позиций;
- Оперативные сроки поставки под заказ (от 5 рабочих дней);
- Экспресс доставка в любую точку России;
- Помощь Конструкторского Отдела и консультации квалифицированных инженеров;
- Техническая поддержка проекта, помощь в подборе аналогов, поставка прототипов;
- Поставка электронных компонентов под контролем ВП;
- Система менеджмента качества сертифицирована по Международному стандарту ISO 9001;
- При необходимости вся продукция военного и аэрокосмического назначения проходит испытания и сертификацию в лаборатории (по согласованию с заказчиком);
- Поставка специализированных компонентов военного и аэрокосмического уровня качества (Xilinx, Altera, Analog Devices, Intersil, Interpoint, Microsemi, Actel, Aeroflex, Peregrine, VPT, Syfer, Eurofarad, Texas Instruments, MS Kennedy, Miteq, Cobham, E2V, MA-COM, Hittite, Mini-Circuits, General Dynamics и др.);

Компания «Океан Электроники» является официальным дистрибьютором и эксклюзивным представителем в России одного из крупнейших производителей разъемов военного и аэрокосмического назначения «JONHON», а так же официальным дистрибьютором и эксклюзивным представителем в России производителя высокотехнологичных и надежных решений для передачи СВЧ сигналов «FORSTAR».



JONHON

«JONHON» (основан в 1970 г.)

Разъемы специального, военного и аэрокосмического назначения:

(Применяются в военной, авиационной, аэрокосмической, морской, железнодорожной, горно- и нефтедобывающей отраслях промышленности)

«FORSTAR» (основан в 1998 г.)

ВЧ соединители, коаксиальные кабели, кабельные сборки и микроволновые компоненты:

(Применяются в телекоммуникациях гражданского и специального назначения, в средствах связи, РЛС, а так же военной, авиационной и аэрокосмической отраслях промышленности).



Телефон: 8 (812) 309-75-97 (многоканальный)

Факс: 8 (812) 320-03-32

Электронная почта: ocean@oceanchips.ru

Web: <http://oceanchips.ru/>

Адрес: 198099, г. Санкт-Петербург, ул. Калинина, д. 2, корп. 4, лит. А