

### GENERAL SPECIFICATIONS FOR S301 ~ S339

Toggles  
A

Rockers

Pushbuttons

Illuminated PB

Programmable

Keylocks

Rotaries

Slides

Tactiles

Tilt

Touch

Indicators

Accessories

Supplement

### Electrical Capacity (Resistive & Inductive Load)

**Power Level:** Shown in the following tables

### Other Ratings

<b>Contact Resistance:</b>	10 milliohms maximum
<b>Insulation Resistance:</b>	1,000 megohms minimum @ 500V DC
<b>Dielectric Strength:</b>	2,000V AC minimum for 1 minute minimum
<b>Mechanical Life:</b>	50,000 operations minimum
<b>Electrical Life:</b>	6,000 operations minimum for S331F; 15,000 operations minimum for all other S331s; 25,000 operations minimum for all others
<b>Angle of Throw (<math>\alpha</math>):</b>	Shown on following tables

### Materials & Finishes

<b>Toggle:</b>	PBT for flatted lever; brass with chrome plating for all others
<b>Bushing:</b>	Brass with chrome plating
<b>Case:</b>	Melamine phenol
<b>Case Cover:</b>	Steel with zinc plating
<b>Movable Contactor:</b>	Copper with silver plating
<b>Movable &amp; Stationary Contacts:</b>	Silver alloy capped on copper with silver plating
<b>Terminals:</b>	Brass with tin plating

### Environmental Data

**Operating Temperature Range:**  $-10^{\circ}\text{C} \sim +70^{\circ}\text{C}$  ( $+14^{\circ}\text{F} \sim +158^{\circ}\text{F}$ )

### Installation

**Mounting Torque:** 2.94Nm (26 lb•in) for double nut; 1.47Nm (13 lb•in) for single nut  
**Soldering Time & Temperature:** Manual Soldering: See Profile A in Supplement section.

### Standards & Certifications

- UL:** File No. E44145 - Recognized only when ordered with marking on switch. Add "/U" or "/CUL" to end of part number to order UL recognized switch. UL or cULus recognition designated beside part numbers on following pages. See Supplement section to find UL or cULus rating details.
- CSA:** File No. 023535\_0\_000 - Certified only when ordered with marking on switch. Add "/C" to end of part number to order CSA certified switch. CSA certification designated beside part numbers on following pages. See Supplement section to find CSA rating details

## SINGLE POLE WITH SOLDER LUG \*

* UL, cULus & CSA recognized only when ordered with marking on switch (see General Specs)			Toggle Position/Connected Terminals ( ) = Momentary						Electrical Capacity			
Model	* Approvals			Pole & Throw	Down Keyway	Center	Up	Resistive			Inductive AC 125V PF 0.6	Angle of Throw
	UL	cULus	CSA					AC 125V	AC 250V	DC 30V		
S301	✓	✓	✓	SPST	ON 1-3	NONE	OFF —	15A	6A	20A	10A	32°
S302	✓	✓	✓	SPDT	ON 2-3	NONE	ON 2-1	15A	6A	20A	10A	32°
S303	✓	✓	✓	SPDT	ON 2-3	OFF	ON 2-1	15A	6A	20A	10A	32°
S305	—	—	✓	SPDT	ON 2-3	NONE	(ON) 2-1	15A	6A	20A	8A	32°
S308	—	—	✓	SPDT	(ON) 2-3	OFF	(ON) 2-1	15A	6A	20A	8A	32°
S309	—	—	✓	SPDT	ON 2-3	OFF	(ON) 2-1	15A	6A	20A	8A	32°

**Throw & Schematics:** SPST INTERNAL CONNECTION Note: Terminal numbers are actually on the switch

**Notes:** Standard Hardware: AT503M Face Hex Nut, AT506M Locking Ring, AT508 Lockwasher, AT527M Backup Hex Nut. See Accessories & Hardware section.  
Optional Splashproof Boot Assemblies: AT401 & AT4181 boots plus hex nut & o-ring. See Accessories & Hardware section.

\* Wire harness & cable assemblies offered only in Americas.

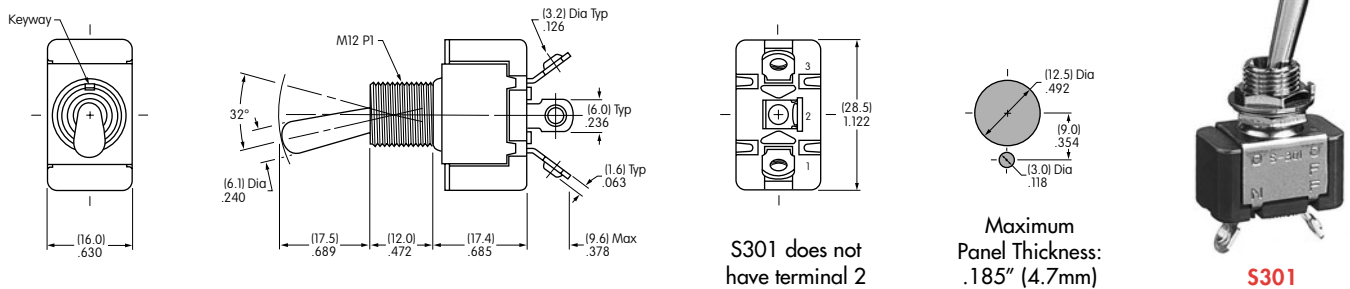

## DOUBLE POLE WITH SOLDER LUG \*

* UL, cULus & CSA recognized only when ordered with marking on switch (see General Specs)			Toggle Position/Connected Terminals ( ) = Momentary						Electrical Capacity			
Model	* Approvals			Pole & Throw	Down Keyway	Center	Up	Resistive			Inductive AC 125V PF 0.6	$\alpha$ = Angle of Throw
	UL	cULus	CSA					AC 125V	AC 250V	DC 30V		
S331	✓	✓	✓	DPST	ON 1-3 4-6	NONE	OFF —	25A	25A	25A	10A	25°
S332	✓	✓	✓	DPDT	ON 2-3 5-6	NONE	ON 2-1 5-4	25A	15A	25A	10A	25°
S333	✓	✓	✓	DPDT	ON 2-3 5-6	OFF	ON 2-1 5-4	25A	15A	25A	10A	30°
S335	✓	✓	✓	DPDT	ON 2-3 5-6	NONE	(ON) 2-1 5-4	15A	6A	20A	8A	25°
S338	✓	✓	—	DPDT	(ON) 2-3 5-6	OFF	(ON) 2-1 5-4	15A	6A	20A	8A	25°
S339	✓	✓	—	DPDT	ON 2-3 5-6	OFF	(ON) 2-1 5-4	15A	6A	20A	8A	25°



**Throw & Schematics:** DPST INTERNAL CONNECTION Note: Terminal numbers are actually on the switch

**Notes:** Standard Hardware: AT503M Face Hex Nut, AT506M Locking Ring, AT508 Lockwasher, AT527M Backup Hex Nut. See Accessories & Hardware section.  
Optional Splashproof Boot Assemblies: AT401 & AT4181 boots plus hex nut & o-ring. See Accessories & Hardware section.

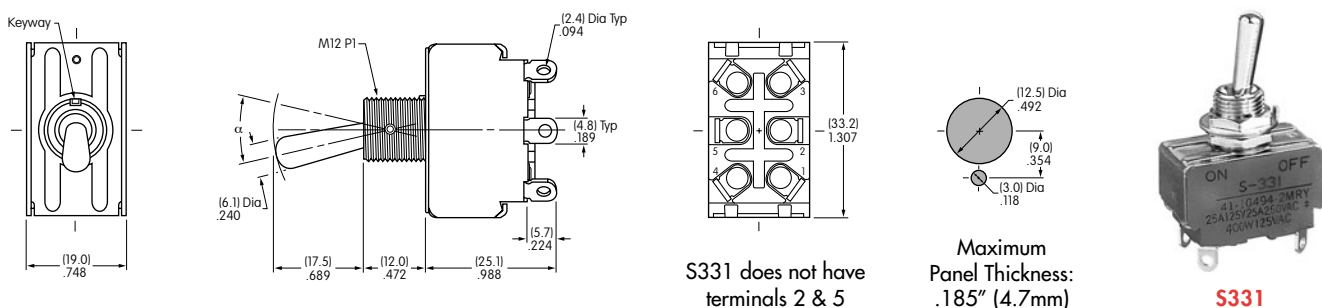
\* Wire harness & cable assemblies offered only in Americas.



### DOUBLE POLE WITH SOLDER LUG & FLATTED LEVER \*

Model	* Approvals			Pole & Throw	Toggle Position/Connected Terminals ( ) = Momentary					Electrical Capacity				$\alpha$ = Angle of Throw
	UL	cULus	CS		Down 	Center 	Up 	Resistive			Inductive			
								AC 125V	AC 250V	DC 30V	AC 125V PF 0.6			
S331R	✓	✓	—	DPST	ON 1-3 4-6	NONE	OFF —	25A	25A	25A	10A	25°		
S332R	✓	✓	—	DPDT	2-3 5-6	NONE	ON 2-1 5-4	25A	15A	25A	10A	25°		
S333R	✓	✓	—	DPDT	ON 2-3 5-6	OFF	ON 2-1 5-4	25A	15A	25A	10A	30°		
S338R	✓	✓	—	DPDT	(ON) 2-3 5-6	OFF	(ON) 2-1 5-4	15A	6A	20A	8A	25°		
S339R	✓	✓	—	DPDT	ON 2-3 5-6	OFF	(ON) 2-1 5-4	15A	6A	20A	8A	25°		

Throw & Schematics:



Note: Terminal numbers are actually on the switch

Notes: Standard Hardware: AT504M Knurled Nut, AT508 Lockwasher, AT527M Backup Hex Nut. See Accessories & Hardware section.

\* Wire harness & cable assemblies offered only in Americas.





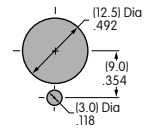
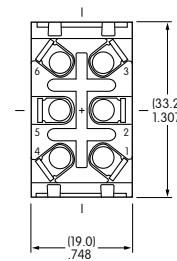
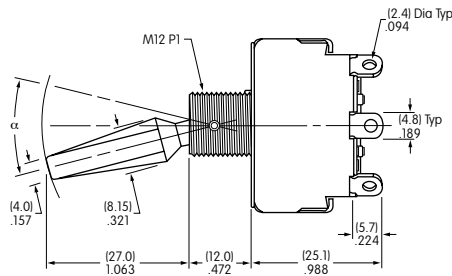
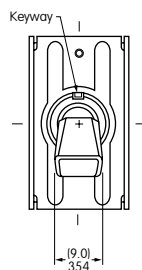



S331R



S331R does not have terminals 2 & 5

Maximum Panel Thickness: .220" (5.6mm)

## SINGLE POLE WITH SCREW LUG

* UL, cULus & CSA recognized only when ordered with marking on switch (see General Specs)			Toggle Position/Connected Terminals ( ) = Momentary					Electrical Capacity				$\alpha$ = Angle of Throw
Model	* Approvals			Pole & Throw	Down 	Center 	Up 	Resistive			Inductive	
								AC 125V	AC 250V	DC 30V	AC 125V PF 0.6	
S301T	✓	✓	✓	SPST	ON 1-3	NONE	OFF —	15A	6A	20A	10A	32°
S302T	✓	✓	✓	SPDT	ON 2-3	NONE	ON 2-1	15A	6A	20A	10A	32°
S303T	✓	✓	✓	SPDT	ON 2-3	OFF	ON 2-1	15A	6A	20A	10A	32°
S305T	—	—	✓	SPDT	ON 2-3	NONE	(ON) 2-1	15A	6A	20A	8A	32°
S308T	—	—	✓	SPDT	(ON) 2-3	OFF	(ON) 2-1	15A	6A	20A	8A	32°
S309T	—	—	✓	SPDT	ON 2-3	OFF	(ON) 2-1	15A	6A	20A	8A	32°

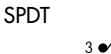
**Throw & Schematics:** SPST  INTERNAL CONNECTION  Note: Terminal numbers are actually on the switch

**Notes:** Standard Hardware: AT503M Face Hex Nut, AT506M Locking Ring, AT508 Lockwasher, AT527M Backup Hex Nut. See Accessories & Hardware section. Optional Splashproof Boot Assemblies: AT401 & AT4181 boots plus hex nut & o-ring. See Accessories & Hardware section.

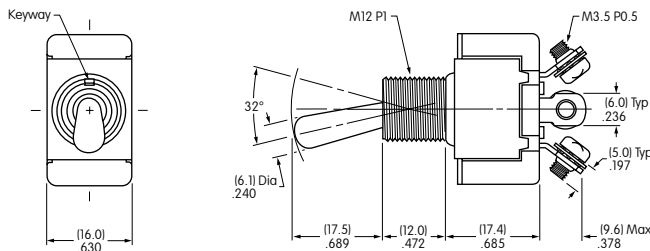

S301T does not have terminal 2

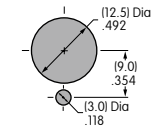







Maximum Panel Thickness: .185" (4.7mm)

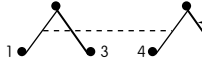

**S301T**

## DOUBLE POLE WITH SCREW LUG

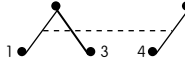
* UL & cULus recognized only when ordered with marking on switch (see General Specs)			Toggle Position/Connected Terminals ( ) = Momentary					Electrical Capacity				$\alpha$ = Angle of Throw
Model	* Approvals			Pole & Throw	Down 	Center 	Up 	Resistive			Inductive	
								AC 125V	AC 250V	DC 30V	AC 125V PF 0.6	
S331T	✓	✓	—	DPST	ON 1-3 4-6	NONE	OFF —	15A	15A	15A	10A	25°
S332T	✓	✓	—	DPDT	ON 2-3 5-6	NONE	ON 2-1 5-4	15A	15A	15A	10A	25°
S333T	✓	✓	—	DPDT	ON 2-3 5-6	OFF	ON 2-1 5-4	15A	15A	15A	10A	30°
S335T	✓	✓	—	DPDT	ON 2-3 5-6	NONE	(ON) 2-1 5-4	15A	6A	20A	8A	25°
S338T	✓	✓	—	DPDT	(ON) 2-3 5-6	OFF	(ON) 2-1 5-4	15A	6A	20A	8A	25°
S339T	✓	✓	—	DPDT	ON 2-3 5-6	OFF	(ON) 2-1 5-4	15A	6A	20A	8A	25°

**Throw & Schematics:** DPST  INTERNAL CONNECTION  Note: Terminal numbers are actually on the switch

**Notes:** Standard Hardware: AT503M Face Hex Nut, AT506M Locking Ring, AT508 Lockwasher, AT527M Backup Hex Nut. See Accessories & Hardware section. Optional Splashproof Boot Assemblies: AT401 & AT4181 boots plus hex nut & o-ring. See Accessories & Hardware section.

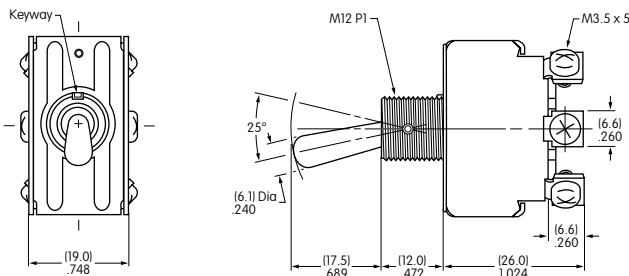

S331T does not have terminals 2 & 5

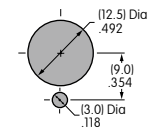

Maximum Panel Thickness: .185" (4.7mm)



**S331T**

Toggles  
A

### SINGLE POLE WITH QUICK CONNECT

* UL, cULus & CSA recognized only when ordered with marking on switch (see General Specs)				Toggle Position/Connected Terminals			Electrical Capacity				α = Angle of Throw	
Model	* Approvals			Pole & Throw	Down	Center	Up	Resistive				Inductive
	UL	cULus	CSA		Keyway			AC 125V	AC 250V	DC 30V		AC 125V PF 0.6
S301F	✓	✓	✓	SPST	ON 1-3	NONE	OFF —	15A	6A	20A	10A	32°

**Throw & Schematics:** SPST  INTERNAL CONNECTION

**Note:** Terminal numbers are actually on the switch

**Notes:** Standard Hardware: AT503M Face Hex Nut, AT506M Locking Ring, AT508 Lockwasher, AT527M Backup Hex Nut. See Accessories & Hardware section. Optional Splashproof Boot Assemblies: AT401 & AT4181 boots plus hex nut & o-ring. See Accessories & Hardware section.



S301F

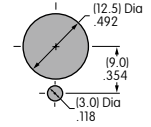
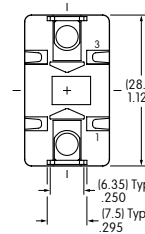
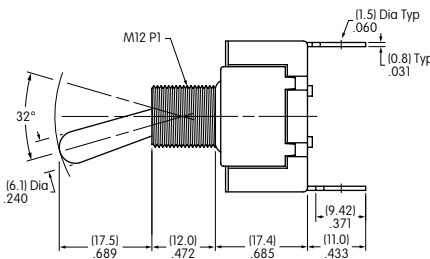
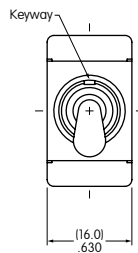

Maximum Panel Thickness: .185" (4.7mm)

### DOUBLE POLE WITH QUICK CONNECT

* UL & cULus recognized only when ordered with marking on switch (see General Specs)				Toggle Position/Connected Terminals ( ) = Momentary			Electrical Capacity				α = Angle of Throw	
Model	* Approvals			Pole & Throw	Down	Center	Up	Resistive				Inductive
	UL	cULus	CSA		Keyway			AC 125V	AC 250V	DC 30V		AC 125V PF 0.6
S331F	✓	✓	—	DPST	ON 1-3 4-6	NONE	OFF —	25A	25A	25A	10A	25°
S332F	✓	✓	—	DPDT	ON 2-3 5-6	NONE	ON 2-1 5-4	25A	15A	25A	10A	25°
S333F	✓	✓	—	DPDT	ON 2-3 5-6	OFF	ON 2-1 5-4	25A	15A	25A	10A	30°
S335F	✓	✓	—	DPDT	ON 2-3 5-6	NONE	(ON) 2-1 5-4	15A	6A	20A	8A	25°

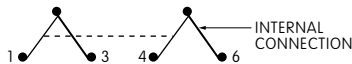
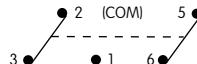
**Throw & Schematics:** DPST  INTERNAL CONNECTION DPDT 

**Note:** Terminal numbers are actually on the switch

**Notes:** Standard Hardware: AT503M Face Hex Nut, AT506M Locking Ring, AT508 Lockwasher, AT527M Backup Hex Nut. See Accessories & Hardware section. Optional Splashproof Boot Assemblies: AT401 & AT4181 boots plus hex nut & o-ring. See Accessories & Hardware section.



S332F

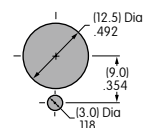
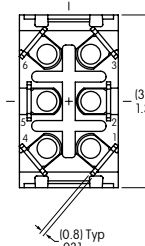
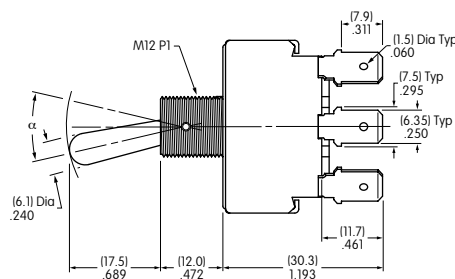
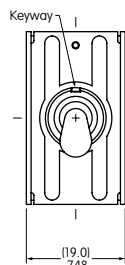

Maximum Panel Thickness: .185" (4.7mm)

S331F does not have terminals 2 & 5

Rockers

Pushbuttons

Illuminated PB

Programmable

Keylocks

Rotaries

Slides

Tactiles

Tilt

Touch

Indicators

Accessories

Supplement

## GENERAL SPECIFICATIONS FOR S31 ~ S49

### Electrical Capacity (Resistive & Inductive Load)

**Power Level:** Shown in the following tables

### Other Ratings

**Contact Resistance:** 10 milliohms maximum  
**Insulation Resistance:** 1,000 megohms minimum @ 500V DC  
**Dielectric Strength:** 2,000V AC minimum for 1 minute minimum  
**Mechanical Life:** 50,000 operations minimum  
**Electrical Life:** 25,000 operations minimum  
**Angle of Throw ( $\alpha$ ):** Shown on following tables

### Materials & Finishes

**Toggle:** PBT resin for flatted lever; brass with chrome plating for all others  
**Bushing:** Brass with chrome plating  
**Case:** Phenolic resin  
**Case Cover:** Steel with chromate plating over zinc plating  
**Movable Contact:** Copper with silver plating  
**Movable Contacts:** Silver alloy capped on copper with silver plating  
**Stationary Contacts:** Silver alloy capped on copper with silver plating  
**Terminals:** Brass with tin plating

### Environmental Data

**Operating Temp Range:** -10°C through +70°C (+14°F through +158°F)

### Installation

**Mounting Torque:** 2.94Nm (26 lb•in) for double nut  
**Maximum Panel Thickness:** Shown beneath panel cutout in switch dimension drawings  
**Soldering Time & Temperature:** Manual Soldering: See Profile A in Supplement section.

### Standards & Certifications

**UL:** File No. E44145 - Recognized only when ordered with marking on switch.  
 Add "/U" or "/CUL" to end of part number to order UL recognized switch.  
 UL or cULus recognition designated beside part numbers on following pages.  
 See Supplement section to find UL or cULus rating details.

**CSA:** File No. 023535\_0\_000 - Certified only when ordered with marking on switch.  
 Add "/C" to end of part number to order CSA certified switch.  
 CSA certification designated beside part numbers on following pages.  
 See Supplement section to find CSA rating details.

A  
Toggles

Rockers

Pushbuttons

Illuminated PB

Programmable

Keylocks

Rotaries

Slides

Tactiles

Tilt

Touch

Indicators

Accessories

Supplement

Toggles **A**

### THREE POLE WITH SOLDER LUG \*

Model	* Approvals			Pole & Throw	Toggle Position/Connected Terminals ( ) = Momentary						Electrical Capacity				$\alpha$ = Angle of Throw	
	UL	cULus	CSA		Down Keyway	Center	Up	Resistive			Inductive AC 125V PF 0.6					
								AC 125V	AC 250V	DC 30V						
S31	✓	✓	✓	3PST	ON	1-3	4-6	7-9	NONE	OFF	—	25A	9A	20A	10A	25°
S32	✓	✓	✓	3PDT	ON	2-3	5-6	8-9	NONE	ON	2-1 5-4 8-7	25A	9A	20A	10A	25°
S33	✓	✓	✓	3PDT	ON	2-3	5-6	8-9	OFF	ON	2-1 5-4 8-7	25A	9A	20A	10A	30°
S35	✓	✓	✓	3PDT	ON	2-3	5-6	8-9	NONE	(ON)	2-1 5-4 8-7	15A	6A	20A	8A	25°
S38	✓	✓	✓	3PDT	(ON)	2-3	5-6	8-9	OFF	(ON)	2-1 5-4 8-7	15A	6A	15A	8A	25°
S39	✓	✓	✓	3PDT	ON	2-3	5-6	8-9	OFF	(ON)	2-1 5-4 8-7	15A	6A	15A	8A	25°

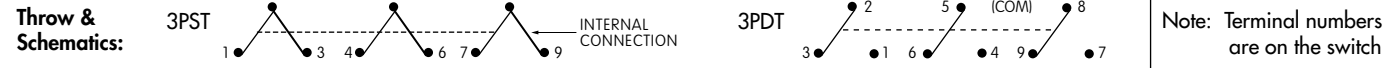

**Notes:** Standard Hardware: AT503M Face Hex Nut, AT506M Locking Ring, AT508 Lockwasher, AT527M Backup Hex Nut. See Accessories & Hardware section.  
Optional Splashproof Boot Assemblies: AT401 & AT4181 boots plus hex nut & o-ring. See Accessories & Hardware section.

\* Wire harness & cable assemblies offered only in Americas.

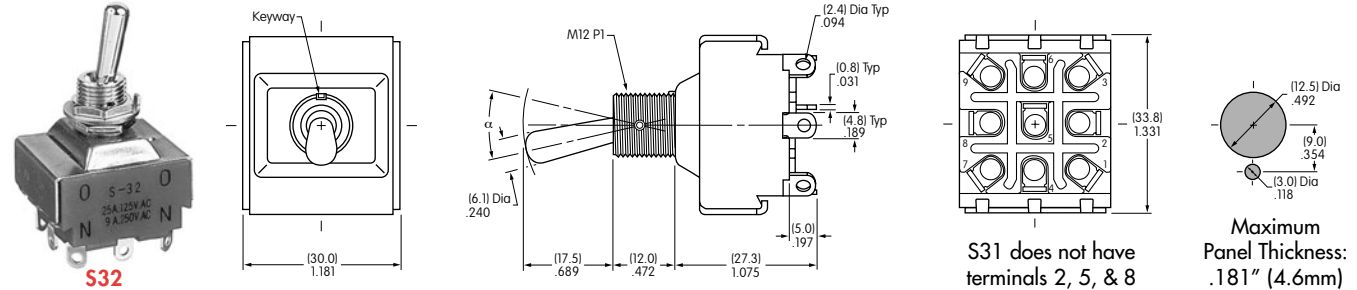

### FOUR POLE WITH SOLDER LUG \*

Model Suffix R = Flatted Lever	* Approvals			Pole & Throw	Toggle Position/Connected Terminals ( ) = Momentary						Electrical Capacity				$\alpha$ = Angle of Throw		
	UL	cULus	CSA		Down Keyway	Center	Up	Resistive			Inductive AC 125V PF 0.6						
								AC 125V	AC 250V	DC 30V							
S41/S41R	✓	✓	✓	4PST	ON	1-3	4-6	7-9	10-12	NONE	OFF	—	25A	9A	20A	10A	25°
S42/S42R	✓	✓	✓	4PDT	ON	2-3	5-6	8-9	11-12	NONE	ON	2-1 5-4 8-7 11-10	25A	9A	20A	10A	25°
S43/S43R	✓	✓	✓	4PDT	ON	2-3	5-6	8-9	11-12	OFF	ON	2-1 5-4 8-7 11-10	25A	9A	20A	10A	30°
S45	—	✓	—	4PDT	ON	2-3	5-6	8-9	11-12	NONE	(ON)	2-1 5-4 8-7 11-10	15A	6A	20A	8A	25°
S48/S48R	✓	✓	—	4PDT	(ON)	2-3	5-6	8-9	11-12	OFF	(ON)	2-1 5-4 8-7 11-10	15A	6A	20A	8A	25°
S49/S49R	✓	✓	—	4PDT	ON	2-3	5-6	8-9	11-12	OFF	(ON)	2-1 5-4 8-7 11-10	15A	6A	20A	8A	25°



**Notes:** Standard Hardware for **Bat Lever**: AT503M Face Hex Nut, AT506M Locking Ring, AT508 Lockwasher, AT527M Backup Hex Nut; for **Flatted Lever (R)**: AT504M Knurled Face Nut, AT508 Lockwasher, AT527M Backup Hex Nut. See Accessories & Hardware section.  
Optional Splashproof Boot Assemblies (only for bat lever models): AT401 & AT4181 boots plus hex nut and o-ring. See Accessories & Hardware section.



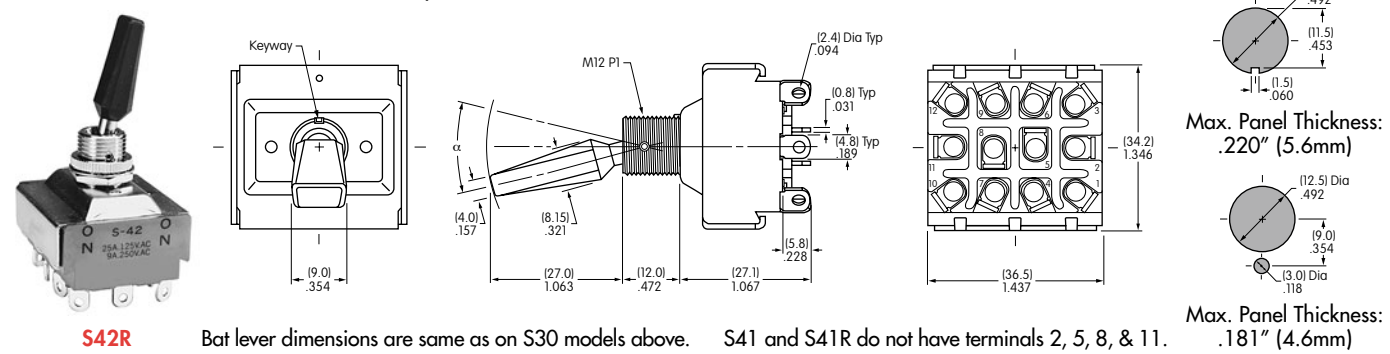

\* Wire harness & cable assemblies offered only in Americas.



Bat lever dimensions are same as on S30 models above. S41 and S41R do not have terminals 2, 5, 8, & 11.

Toggles  
Rockers  
Pushbuttons  
Illuminated PB  
Programmable  
Keylocks  
Rotaries  
Slides  
Tactiles  
Tilt  
Touch  
Indicators  
Accessories  
Supplement

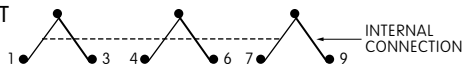
## THREE POLE WITH SCREW LUG

* UL, cULus & CSA recognized only when ordered with marking on switch (see General Specs)			Toggle Position/Connected Terminals						Electrical Capacity					α = Angle of Throw
Model	* Approvals			Pole & Throw	Down 	Center 	Up 	Resistive			Inductive			
								AC 125V	AC 250V	DC 30V	AC 125V PF 0.6	AC 250V PF 0.6		
S31T	✓	✓	✓	3PST	ON 1-3 4-6 7-9	NONE	OFF —	25A	9A	20A	10A	5A	25°	
S32T	✓	✓	✓	3PDT	ON 2-3 5-6 8-9	NONE	ON 2-1 5-4 8-7	25A	9A	20A	10A	5A	25°	
S33T	✓	✓	✓	3PDT	ON 2-3 5-6 8-9	OFF	ON 2-1 5-4 8-7	25A	9A	20A	10A	5A	30°	

**Throw & Schematics:**

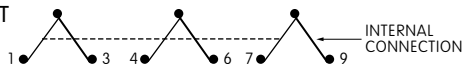
3PST:  INTERNAL CONNECTION

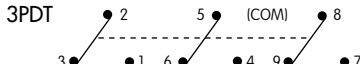
3PDT:  (COM) 8





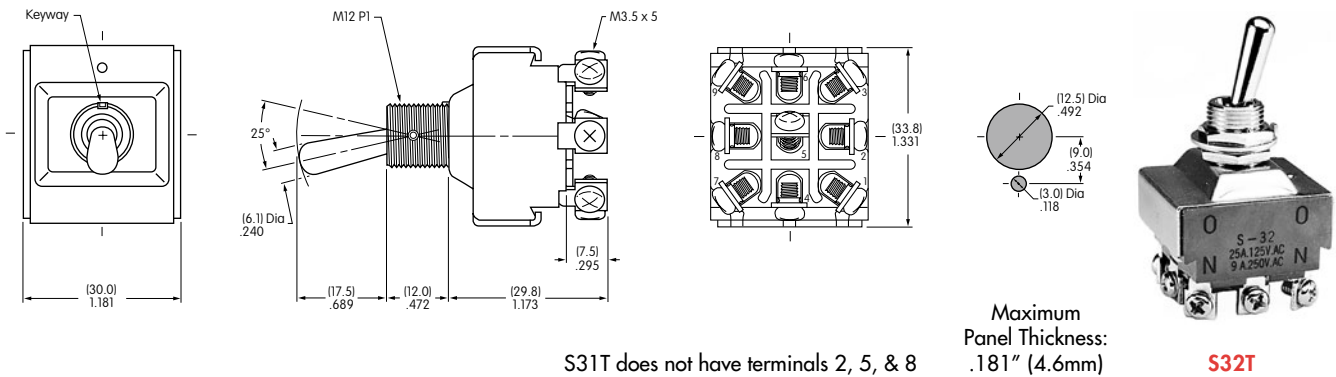

Note: Terminal numbers are on the switch

**Notes:** Standard Hardware: AT503M Face Hex Nut, AT506M Locking Ring, AT508 Lockwasher, AT527M Backup Hex Nut. See Accessories & Hardware section. Optional Splashproof Boot Assemblies: AT401 & AT4181 boots plus hex nut & o-ring. See Accessories & Hardware section.



S31T does not have terminals 2, 5, & 8

## FOUR POLE WITH SCREW LUG

* UL, cULus & CSA recognized only when ordered with marking on switch (see General Specs)			Toggle Position/Connected Terminals						Electrical Capacity					α = Angle of Throw
Model	* Approvals			Pole & Throw	Down 	Center 	Up 	Resistive			Inductive			
								AC 125V	AC 250V	DC 30V	AC 125V PF 0.6	AC 250V PF 0.6		
S41T	✓	✓	✓	4PST	ON 1-3 4-6 7-9 10-12	NONE	OFF —	25A	9A	20A	10A	5A	25°	
S42T	✓	✓	✓	4PDT	ON 2-3 5-6 8-9 11-12	NONE	ON 2-1 5-4 8-7 11-10	25A	9A	20A	10A	5A	25°	
S43T	✓	✓	✓	4PDT	ON 2-3 5-6 8-9 11-12	OFF	ON 2-1 5-4 8-7 11-10	25A	9A	20A	10A	5A	30°	

**Throw & Schematics:**

4PST:  INTERNAL CONNECTION

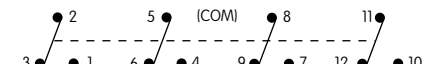
4PDT:  (COM) 8

Note: Terminal numbers are on the switch

**Notes:** Standard Hardware: AT503M Face Hex Nut, AT506M Locking Ring, AT508 Lockwasher, AT527M Backup Hex Nut. See Accessories & Hardware section. Optional Splashproof Boot Assemblies: AT401 & AT4181 boots plus hex nut & o-ring. See Accessories & Hardware section.

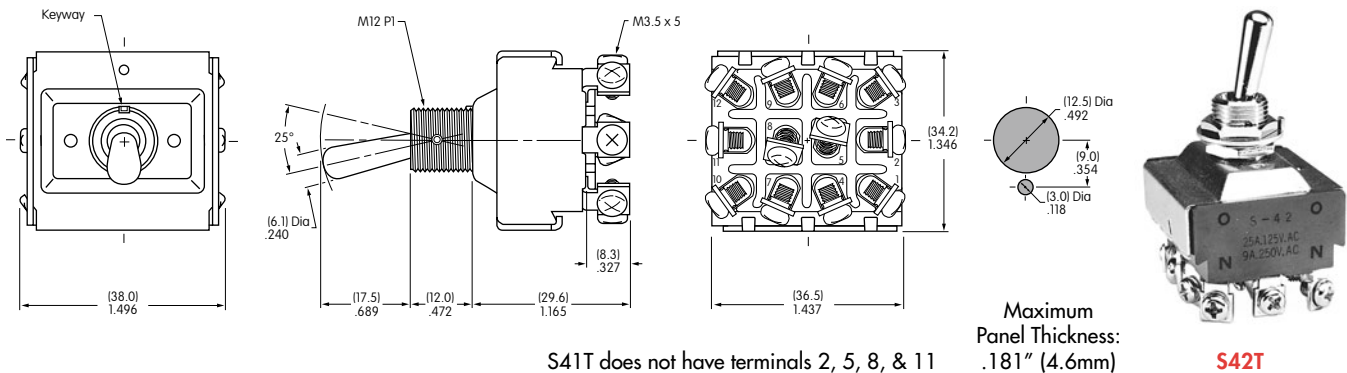



S41T does not have terminals 2, 5, 8, & 11



Toggles **A**

### THREE POLE WITH QUICK CONNECT

* UL, cULus & CSA recognized only when ordered with marking on switch (see General Specs)				Toggle Position/Connected Terminals					Electrical Capacity				α = Angle of Throw
Model	* Approvals			Pole & Throw	Down 	Center 	Up 	Resistive			Inductive		
	UL	cULus	CSA					AC 125V	AC 250V	DC 30V	AC 125V PF 0.6		
S31F	✓	✓	✓	3PST	ON 1-3 4-6 7-9	NONE	OFF —	25A	9A	20A	10A	25°	
S32F	✓	✓	✓	3PDT	ON 2-3 5-6 8-9	NONE	ON 2-1 5-4 8-7	25A	9A	20A	10A	25°	
S33F	✓	✓	✓	3PDT	ON 2-3 5-6 8-9	OFF	ON 2-1 5-4 8-7	25A	9A	20A	10A	30°	

**Throw & Schematics:**



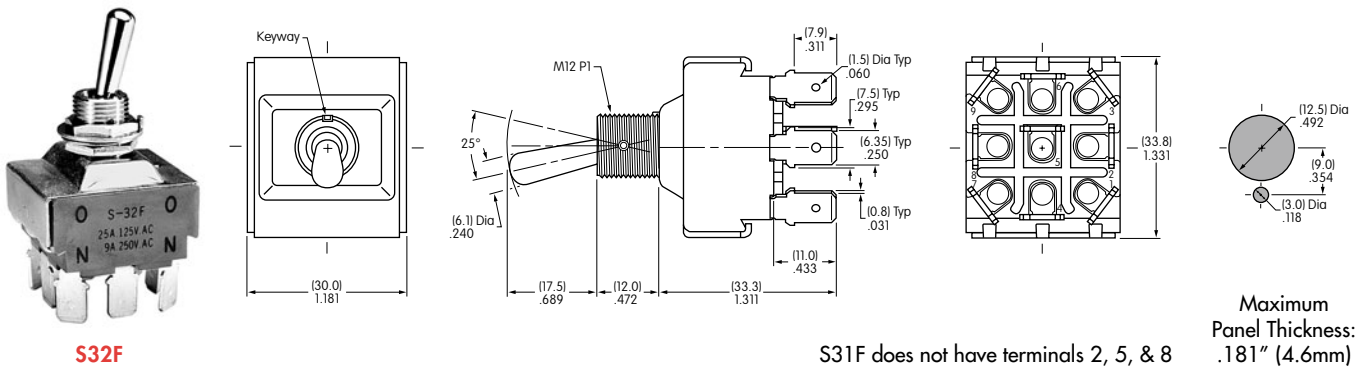

Note: Terminal numbers are on the switch

**Notes:** Standard Hardware: AT503M Face Hex Nut, AT506M Locking Ring, AT508 Lockwasher, AT527M Backup Hex Nut. See Accessories & Hardware section. Optional Splashproof Boot Assemblies: AT401 & AT4181 boots plus hex nut & o-ring. See Accessories & Hardware section.



### FOUR POLE WITH QUICK CONNECT

* UL, cULus & CSA recognized only when ordered with marking on switch (see General Specs)				Toggle Position/Connected Terminals					Electrical Capacity				α = Angle of Throw
Model	* Approvals			Pole & Throw	Down 	Center 	Up 	Resistive			Inductive		
	UL	cULus	CSA					AC 125V	AC 250V	DC 30V	AC 125V PF 0.6		
S41F	✓	✓	✓	4PST	ON 1-3 4-6 7-9 10-12	NONE	OFF —	25A	9A	20A	10A	25°	
S42F	✓	✓	✓	4PDT	ON 2-3 5-6 8-9 11-12	NONE	ON 2-1 5-4 8-7 11-10	25A	9A	20A	10A	25°	
S43F	✓	✓	✓	4PDT	ON 2-3 5-6 8-9 11-12	OFF	ON 2-1 5-4 8-7 11-10	25A	9A	20A	10A	30°	

**Throw & Schematics:**

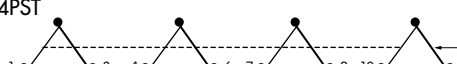

Note: Terminal numbers are on the switch

**Notes:** Standard Hardware: AT503M Face Hex Nut, AT506M Locking Ring, AT508 Lockwasher, AT527M Backup Hex Nut. See Accessories & Hardware section. Optional Splashproof Boot Assemblies: AT401 & AT4181 boots plus hex nut & o-ring. See Accessories & Hardware section.

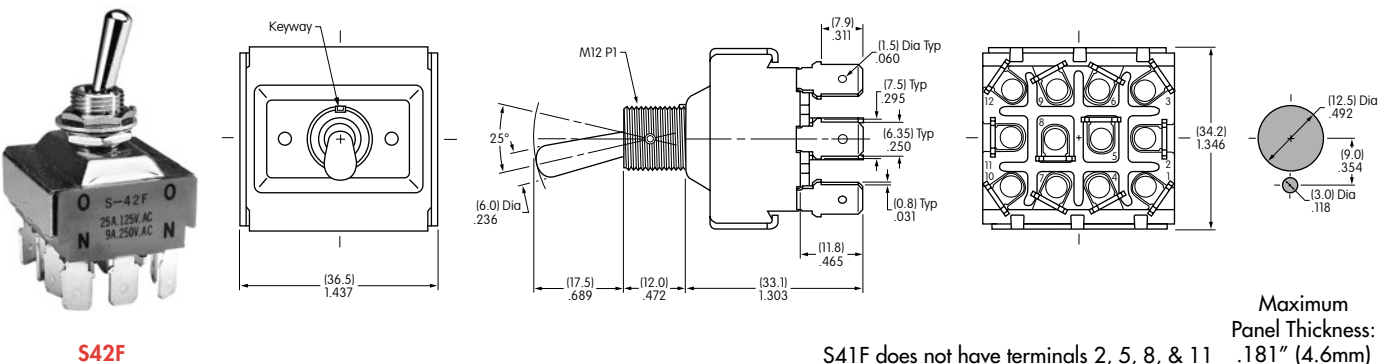

Rockers

Pushbuttons

Illuminated PB

Programmable

Keylocks

Rotaries

Slides

Tactiles

Tilt

Touch

Indicators

Accessories

Supplement

## GENERAL SPECIFICATIONS FOR S421 ~ S429

### Electrical Capacity (Resistive & Inductive Load)

**Power Level:** Shown in the following tables

### Other Ratings

**Contact Resistance:** 10 milliohms maximum  
**Insulation Resistance:** 1,000 megohms minimum @ 500V DC  
**Dielectric Strength:** 2,000V AC minimum for 1 minute minimum  
**Mechanical Life:** 50,000 operations minimum  
**Electrical Life:** 15,000 operations minimum  
**Angle of Throw ( $\alpha$ ):** Shown in tables on following pages

### Materials & Finishes

**Toggle:** Brass with chrome plating  
**Bushing:** Brass with chrome plating  
**Case:** Melamine phenol  
**Case Cover:** Steel with chromate plating over zinc plating  
**Movable Contactor:** Copper with silver plating  
**Movable Contacts:** Silver alloy capped on copper with silver plating  
**Stationary Contacts:** Silver alloy capped on copper with silver plating  
**Terminals:** Brass with tin plating

### Environmental Data

**Operating Temp Range:** -10°C through +70°C (+14°F through +158°F)

### Installation

**Mounting Torque:** 2.94Nm (26 lb·in) for double nut  
**Maximum Panel Thickness:** Shown beneath panel cutout in switch dimension drawings  
**Soldering Time & Temperature:** Manual Soldering: See Profile A in Supplement section.

A  
Toggles

Rockers

Pushbuttons

Illuminated PB

Programmable

Keylocks

Rotaries

Slides

Tactiles

Tilt

Touch



Indicators

Accessories

Supplement

Toggles  
A

## DOUBLE POLE WITH SOLDER LUG \*

Model	Approvals		Pole & Throw	Toggle Position/Connected Terminals ( ) = Momentary						Electrical Capacity				Motor Load AC 125V	$\alpha$ = Angle of Throw
	UL	CSA		Down 	Center 	Up 	Resistive		Inductive						
							AC 125V	AC 250V	PF 0.75 - 0.8 AC 125V	AC 250V					
S421	—	—	DPST	ON	1-3 4-6	NONE	OFF	—	25A	25A	25A	25A	750W	24°	
S422	—	—	DPDT	ON	2-3 5-6	NONE	ON	2-1 5-4	25A	25A	25A	25A	750W	24°	
S423	—	—	DPDT	ON	2-3 5-6	OFF	ON	2-1 5-4	25A	25A	25A	25A	750W	28°	
S425	—	—	DPDT	ON	2-3 5-6	NONE	(ON)	2-1 5-4	15A	15A	15A	15A	400W	24°	
S428	—	—	DPDT	(ON)	2-3 5-6	OFF	(ON)	2-1 5-4	15A	15A	15A	15A	400W	24°	
S429	—	—	DPDT	ON	2-3 5-6	OFF	(ON)	2-1 5-4	15A	15A	15A	15A	400W	24°	

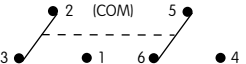
**Throw & Schematics:** DPST  INTERNAL CONNECTION  Note: Terminal numbers are on the switch

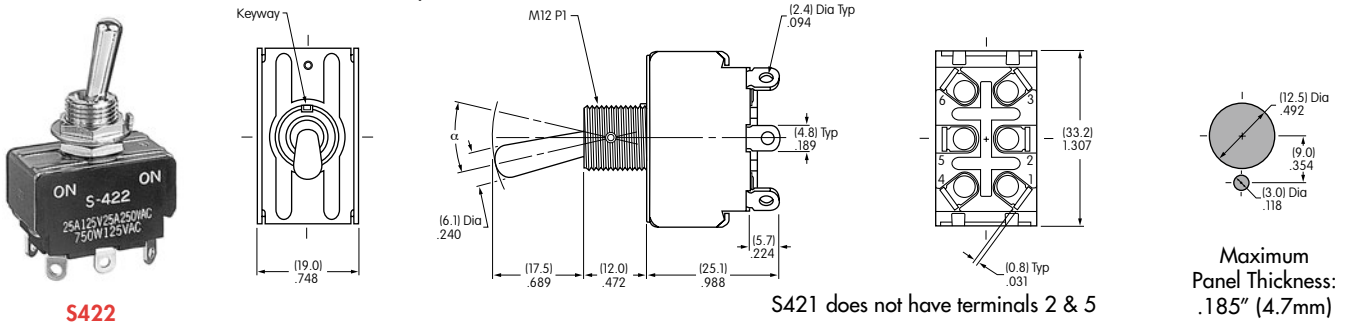

**Notes:** Standard Hardware: AT503M Face Hex Nut, AT506M Locking Ring, AT508 Lockwasher, AT527M Backup Hex Nut. See Accessories & Hardware section.  
Optional Splashproof Boot Assemblies: AT401 & AT4181 boots plus hex nut & o-ring. See Accessories & Hardware section.

\* Wire harness & cable assemblies offered only in Americas.



S422

## DOUBLE POLE WITH SCREW LUG

Model	Approvals		Pole & Throw	Toggle Position/Connected Terminals ( ) = Momentary						Electrical Capacity				Motor Load AC 125V	$\alpha$ = Angle of Throw
	UL	CSA		Down 	Center 	Up 	Resistive		Inductive						
							AC 125V	AC 250V	PF 0.75 - 0.8 AC 125V	AC 250V					
S421T	—	—	DPST	ON	1-3 4-6	NONE	OFF	—	20A	20A	20A	20A	750W	24°	
S422T	—	—	DPDT	ON	2-3 5-6	NONE	ON	2-1 5-4	20A	20A	20A	20A	750W	24°	
S423T	—	—	DPDT	ON	2-3 5-6	OFF	ON	2-1 5-4	20A	20A	20A	20A	750W	28°	
S425T	—	—	DPDT	ON	2-3 5-6	NONE	(ON)	2-1 5-4	15A	15A	15A	15A	400W	24°	
S428T	—	—	DPDT	(ON)	2-3 5-6	OFF	(ON)	2-1 5-4	15A	15A	15A	15A	400W	24°	
S429T	—	—	DPDT	ON	2-3 5-6	OFF	(ON)	2-1 5-4	15A	15A	15A	15A	400W	24°	

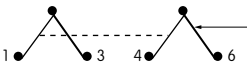
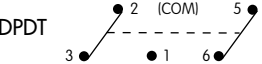
**Throw & Schematics:** DPST  INTERNAL CONNECTION  Note: Terminal numbers are on the switch

**Notes:** Standard Hardware: AT503M Face Hex Nut, AT506M Locking Ring, AT508 Lockwasher, AT527M Backup Hex Nut. See Accessories & Hardware section.  
Optional Splashproof Boot Assemblies: AT401 & AT4181 boots plus hex nut & o-ring. See Accessories & Hardware section.

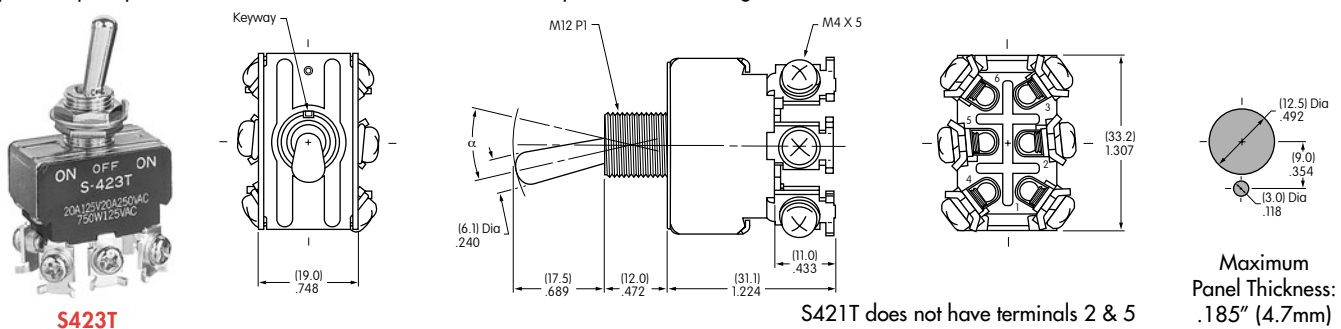

S423T

S421T does not have terminals 2 & 5

Maximum Panel Thickness: .185" (4.7mm)

Компания «Океан Электроники» предлагает заключение долгосрочных отношений при поставках импортных электронных компонентов на взаимовыгодных условиях!

Наши преимущества:

- Поставка оригинальных импортных электронных компонентов напрямую с производств Америки, Европы и Азии, а так же с крупнейших складов мира;
- Широкая линейка поставок активных и пассивных импортных электронных компонентов (более 30 млн. наименований);
- Поставка сложных, дефицитных, либо снятых с производства позиций;
- Оперативные сроки поставки под заказ (от 5 рабочих дней);
- Экспресс доставка в любую точку России;
- Помощь Конструкторского Отдела и консультации квалифицированных инженеров;
- Техническая поддержка проекта, помощь в подборе аналогов, поставка прототипов;
- Поставка электронных компонентов под контролем ВП;
- Система менеджмента качества сертифицирована по Международному стандарту ISO 9001;
- При необходимости вся продукция военного и аэрокосмического назначения проходит испытания и сертификацию в лаборатории (по согласованию с заказчиком);
- Поставка специализированных компонентов военного и аэрокосмического уровня качества (Xilinx, Altera, Analog Devices, Intersil, Interpoint, Microsemi, Actel, Aeroflex, Peregrine, VPT, Syfer, Eurofarad, Texas Instruments, MS Kennedy, Miteq, Cobham, E2V, MA-COM, Hittite, Mini-Circuits, General Dynamics и др.);

Компания «Океан Электроники» является официальным дистрибьютором и эксклюзивным представителем в России одного из крупнейших производителей разъемов военного и аэрокосмического назначения «JONHON», а так же официальным дистрибьютором и эксклюзивным представителем в России производителя высокотехнологичных и надежных решений для передачи СВЧ сигналов «FORSTAR».



## JONHON

«JONHON» (основан в 1970 г.)

Разъемы специального, военного и аэрокосмического назначения:

(Применяются в военной, авиационной, аэрокосмической, морской, железнодорожной, горно- и нефтедобывающей отраслях промышленности)

«FORSTAR» (основан в 1998 г.)

ВЧ соединители, коаксиальные кабели, кабельные сборки и микроволновые компоненты:

(Применяются в телекоммуникациях гражданского и специального назначения, в средствах связи, РЛС, а так же военной, авиационной и аэрокосмической отраслях промышленности).



Телефон: 8 (812) 309-75-97 (многоканальный)

Факс: 8 (812) 320-03-32

Электронная почта: [ocean@oceanchips.ru](mailto:ocean@oceanchips.ru)

Web: <http://oceanchips.ru/>

Адрес: 198099, г. Санкт-Петербург, ул. Калинина, д. 2, корп. 4, лит. А