



# W57 series

## Compact, Push To Reset Only P&B Thermal Circuit Breaker



### Features

- New, compact design.
- 3 to 20 amp ratings.
- Cannot be manually tripped.
- Button extends for visual trip indication.
- Push button to reset breaker.
- Numerous mounting and termination options.
- Optional bottom marking of amperage rating.

### Agency Approvals

W57 series is UL1077 Recognized as Supplementary Protectors, File E69543, for Canada and the United States. Available models meet Ignition Protection requirements in accordance with UL1500. Approved to VDE 0642/EN60934 (Circuit Breakers for Equipment) License Number 40007874 (excludes models rated 3-4A and >15A). CCC mark compliant, certificate 2004010307123217.

Users should thoroughly review the technical data before selecting a product part number. It is recommended that users also seek out the pertinent approvals files of the agencies/laboratories and review them to confirm the product meets the requirements for a given application.

### Electrical Data @ 25°C

**Calibration:** Will continuously carry 100% of rating. May trip between 101% and 134%, but must trip at 135% of rating within one hour at +25°C.

**Dielectric Strength:** 1,500VAC (60 seconds).

**Insulation Resistance:** 100 megohms.  
**Maximum Operating Voltages:** 50VDC; 250VAC, 50/60 Hz.  
**Interrupt Capacity:** 1,000 amps in accordance with UL standard 1077.  
**Resettable Overload Capacity:** Ten times rated current.  
**Reset Time:** 60 seconds.

### Typical Resistance vs. Current Rating @ +25°C

Current Rating in Amps	Typical Resistance in Ohms	Current Rating in Amps	Typical Resistance in Ohms
3.0	0.083	8.0	0.031
4.0	0.062	10.0	0.025
5.0	0.050	12.0	0.021
6.0	0.042	15.0	0.017
7.0	0.036	20.0	0.012

### Mechanical/Environmental Data

**Operating Temperature Range:** 0°C to +60°C.  
**Termination:** .250" (6.35mm) quick connects.  
**Mounting:** Various options. See Ordering Information and drawings.  
**Approximate Weight:** 0.5 oz. (14.3g).

### Time vs. Current Trip Curve @ +25°C

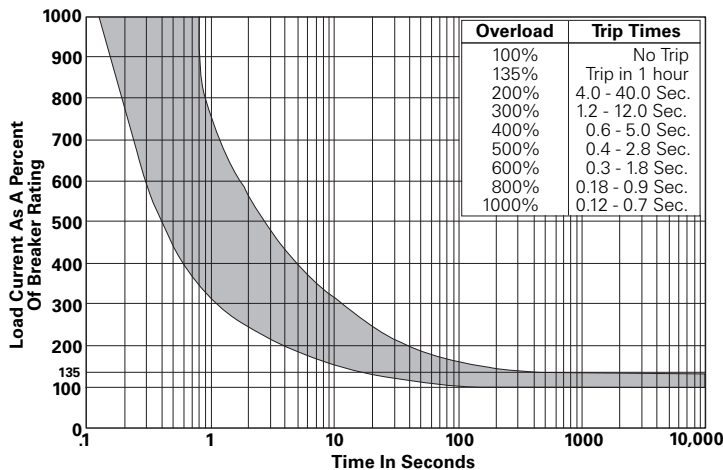

### Outline Dimensions



### Optional Protective Boot

Silicone rubber boot is bonded to integral aluminum nut.

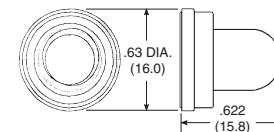

**1-1423696-5**  
Black boot for W57 with 3/8"-24 bushing.

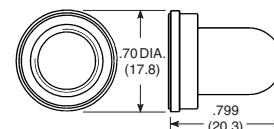

**1-1423696-6**  
Clear boot for W57 with M11 X 1.0 bushing.

### Ambient Compensation Table

Ambient Temperature in °C	Rating Correction Factor	
	3-4A Models	5-20A Models
-10	.70	.77
0	.75	.85
10	.82	.90
20	.90	.95
25	1.00	1.00
30	1.10	1.05
40	1.25	1.15
50	1.61	1.25
60	2.15	1.40

**To use this chart:** Divide the breaker rating by the correction factor to determine the compensated rating. Calculate the overloads in terms of the compensated rating to use the published trip curve. Do not use these devices outside their specified operating temperature ranges.

**Ordering Information**

<b>Typical Part No. &gt;</b>	<b>W</b>	<b>57</b>	<b>-X</b>	<b>B</b>	<b>1</b>	<b>A</b>	<b>4</b>	<b>A</b>	<b>1</b>	<b>0</b>	<b>-4</b>
<b>1. Designator:</b> W = Circuit breaker											
<b>2. Series Number:</b> 57 = Compact, Single Pole, Push-to-Reset, Thermal Model											
<b>3. Circuit Function:</b> X = Series Trip											
<b>4. Button Color &amp; Rate Marking:</b> A = White, plain, no rate marking B = White, red rate marking (vertical) C = White, black rate marking (vertical) D = Black, plain, no rate marking E = Black, white rate marking (horizontal) F = White, red rate marking (horizontal) G = White, black rate marking (horizontal) H = Black, white rate marking (vertical) I = Red, plain, no rate marking J = Black, no rate marking on button, white rate marking on bottom of case between terminals.											
<b>5. Mounting Bushing:</b> 1 = Plastic, 9.8mm (double D) X 9.6mm long, M11x1 threads, (similar to 7/16"), hex base 2 = Plastic, 3/8" (single D) x 10.5mm long, 3/8"x24 threads, hex base 4 = Plastic, snap-in type 5 = Metal, 9.8mm (double D) X 9.6mm long, M11x1 threads, (similar to 7/16"), round base 6 = Metal, 3/8" (single D) x 10.5mm long, 3/8"x24 threads, hex base 7 = Metal, 10.8mm (double D) x 9.6mm long, M12x1 threads, (similar to 15/32"), round base 8 = Metal, 3/8" (double D) x 10.0mm long, 3/8"x24 threads, hex base Notes: Codes 1 and 3 are similar in size to 7/16" bushings (not exact equivalent). Code 7 is similar in size to a 15/32" bushing (not exact equivalent)											
<b>6. Terminals:</b> (see drawings for detail) A = Quick connect .250" (6.35mm) straight B = Quick connect .250" (6.35mm) , bent 90° C = Quick connect .250" (6.35mm) , bent 45° D = Quick connect .250" (6.35mm) , bent 90° E = Quick connect .250" (6.35mm) , bent 90°, PCB compatible F = Quick connect .250" (6.35mm) , bent 90°, PCB compatible G = Quick connect .250" (6.35mm) , straight (smaller hole) H = One quick connect .250" (6.35mm) , one #8-32 screw bent 90° I = Same as F above, but amperage marking reversed.											
<b>7. Mounting Hardware:</b> 4 = Metal knurled nut/hex nut 6 = Metal hex nut 12 = Metal knurled nut 15 = 2 metal hex nuts, metal lockwasher 18 = Metal hex nut, metal lockwasher 7 = Plastic knurled nut 8 = Plastic knurled nut with small hole 22 = Plastic knurled nut, metal lockwasher 99 = None											
<b>8. Mounting Hardware Packaging:</b> A = Assembled to bushing B = Bulk unassembled C = No mounting hardware.											
<b>9. Maximum Operating Voltage (AC):</b> 1 = 250VAC 2 = 125VAC/50VDC											
<b>10. Nameplate:</b> 0 = None 1 = Embossed aluminum 2 = Silver color printing on black color 3 = Black color printing on silver color											
<b>11. Specify Amp Rating:</b> 3† 4† 5 6 7 8 10 12 15 20† †Not VDE											
<b>12. UL Recognition:</b> Leave Blank = UL1077 recognized breaker M = Model meeting Ignition Protection requirements in accordance with UL1500, in addition to UL1077 recognition† †Not VDE											

**Our authorized distributors are more likely to stock the following items for immediate delivery.**

- W57-XB1A4A10-5    W57-XB1A4A10-15    W57-XB1A5A10-5    W57-XB1A5A10-15
- W57-XB1A4A10-10    W57-XB1A4A10-20    W57-XB1A5A10-10    W57-XB1A5A10-20

**ORDERING NOTE:** Mounting hardware can be ordered separately. Some options are subject to extended leadtimes and significant minimum order quantities.

**Mounting Bushings and Recommended Panel Cutouts**



Termination Options



Option A  
.250 QC  
Straight



Option C  
.250 QC  
45°

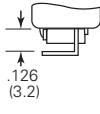

Option D  
.250 QC  
90°



Option E  
.250 QC/PCB  
270°



Option B  
.250 QC  
90°



Option F or I  
.250 QC/PCB  
270°



Option G  
.250 QC Straight  
(small hole)



Option H  
.250 QC Straight  
with #8-32 Load  
Term. Bent 90°

Mounting Hardware Options

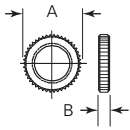

Knurled Nut

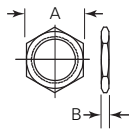

Hex Nut



Integrated Knurled Nut  
with Small Holes

ALTERNATE TEETH TWISTED  
IN OPPOSITE DIRECTIONS

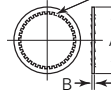

Lockwasher

Optional Bottom Marking of Rating

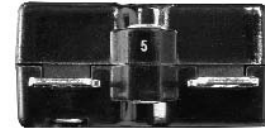

Mounting Hardware Dimensions

Dimension Code	Bushing Diameter	Plastic Knurled Nut	Integrated Plastic Knurled Nut w/Holes	Metal Knurled Nut	Metal Hex Nut	Lockwasher
A	3/8"	.74 (18.8)	-	.56 (14.2)	.55 (14.0)	.49 (12.5)
	M11	.74 (18.8)	.74 (18.8)	.59 (15.0)	.55 (14.0)	.587 (14.9)
	M12	-	-	.59 (15.0)	.55 (14.0)	.626 (15.9)
B	3/8"	.126 (3.2)	-	.079 (2.0)	.079 (2.0)	.02 (.5)
	M11	.126 (3.2)	.13 (3.3)	.102 (2.6)	.118 (3.0)	.02 (.5)
	M12	-	-	.102 (2.6)	.079 (2.0)	.02 (.5)

Mounting Hardware Ordering Information

Mounting Bushing Material	Mounting Bushing Code	Plastic Knurled Nut	Integrated Plastic Knurled Nut w/Holes	Metal Knurled Nut	Metal Hex Nut	Lockwasher
Plastic	1 (M11)	-	1423696-8	2-1423696-2	-	-
	2 (3/8")	-	1423696-2	-	-	-
Metal	5 (M11)	-	-	1423696-4	1423696-6	1-1423696-2
	6 (3/8")	-	-	1-1423696-0	1423696-3	1-1423696-1
	7 (M12)	-	-	1423696-5	1423696-7	1-1423696-3
	8 (3/8")	-	-	1-1423696-0	1423696-3	1-1423696-1

Nameplates



.016 (.4) THICK  
Embossed Aluminum



.016 (.4) THICK  
Imprinted Aluminum  
(Either Silver on Black  
or Black on Silver)

Компания «Океан Электроники» предлагает заключение долгосрочных отношений при поставках импортных электронных компонентов на взаимовыгодных условиях!

Наши преимущества:

- Поставка оригинальных импортных электронных компонентов напрямую с производств Америки, Европы и Азии, а так же с крупнейших складов мира;
- Широкая линейка поставок активных и пассивных импортных электронных компонентов (более 30 млн. наименований);
- Поставка сложных, дефицитных, либо снятых с производства позиций;
- Оперативные сроки поставки под заказ (от 5 рабочих дней);
- Экспресс доставка в любую точку России;
- Помощь Конструкторского Отдела и консультации квалифицированных инженеров;
- Техническая поддержка проекта, помощь в подборе аналогов, поставка прототипов;
- Поставка электронных компонентов под контролем ВП;
- Система менеджмента качества сертифицирована по Международному стандарту ISO 9001;
- При необходимости вся продукция военного и аэрокосмического назначения проходит испытания и сертификацию в лаборатории (по согласованию с заказчиком);
- Поставка специализированных компонентов военного и аэрокосмического уровня качества (Xilinx, Altera, Analog Devices, Intersil, Interpoint, Microsemi, Actel, Aeroflex, Peregrine, VPT, Syfer, Eurofarad, Texas Instruments, MS Kennedy, Miteq, Cobham, E2V, MA-COM, Hittite, Mini-Circuits, General Dynamics и др.);

Компания «Океан Электроники» является официальным дистрибьютором и эксклюзивным представителем в России одного из крупнейших производителей разъемов военного и аэрокосмического назначения «JONHON», а так же официальным дистрибьютором и эксклюзивным представителем в России производителя высокотехнологичных и надежных решений для передачи СВЧ сигналов «FORSTAR».



## JONHON

«JONHON» (основан в 1970 г.)

Разъемы специального, военного и аэрокосмического назначения:

(Применяются в военной, авиационной, аэрокосмической, морской, железнодорожной, горно- и нефтедобывающей отраслях промышленности)

«FORSTAR» (основан в 1998 г.)

ВЧ соединители, коаксиальные кабели,  
кабельные сборки и микроволновые компоненты:

(Применяются в телекоммуникациях гражданского и специального назначения, в средствах связи, РЛС, а так же военной, авиационной и аэрокосмической отраслях промышленности).



Телефон: 8 (812) 309-75-97 (многоканальный)

Факс: 8 (812) 320-03-32

Электронная почта: [ocean@oceanchips.ru](mailto:ocean@oceanchips.ru)

Web: <http://oceanchips.ru/>

Адрес: 198099, г. Санкт-Петербург, ул. Калинина, д. 2, корп. 4, лит. А