

# MC74HC365A

## Hex 3-State Noninverting Buffer with Common Enables

### High-Performance Silicon-Gate CMOS

The MC74HC365A is identical in pinout to the LS365. The device inputs are compatible with standard CMOS outputs; with pullup resistors, they are compatible with LSTTL outputs.

This device is a high-speed hex buffer with 3-state outputs and two common active-low Output Enables. When either of the enables is high, the buffer outputs are placed into high-impedance states. The HC365A has noninverting outputs.

#### Features

- Output Drive Capability: 15 LSTTL Loads
- Outputs Directly Interface to CMOS, NMOS, and TTL
- Operating Voltage Range: 2.0 to 6.0 V
- Low Input Current: 1.0  $\mu$ A
- High Noise Immunity Characteristic of CMOS Devices
- In Compliance with the Requirements Defined by JEDEC Standard No. 7A
- Chip Complexity: 90 FETs or 22.5 Equivalent Gates
- These are Pb-Free Devices\*



ON Semiconductor®

<http://onsemi.com>

#### MARKING DIAGRAMS

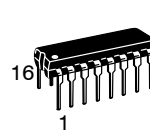

PDIP-16  
N SUFFIX  
CASE 648

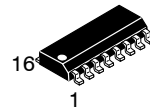
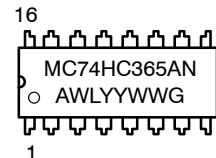

SOIC-16  
D SUFFIX  
CASE 751B

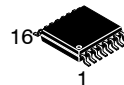
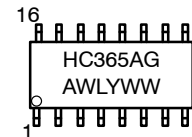

TSSOP-16  
DT SUFFIX  
CASE 948F

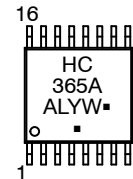

A = Assembly Location  
WL, L = Wafer Lot  
YY, Y = Year  
WW, W = Work Week  
G or ■ = Pb-Free Package  
(Note: Microdot may be in either location)

#### ORDERING INFORMATION

See detailed ordering and shipping information in the package dimensions section on page 2 of this data sheet.

\*For additional information on our Pb-Free strategy and soldering details, please download the ON Semiconductor Soldering and Mounting Techniques Reference Manual, SOLDERRM/D.

# MC74HC365A

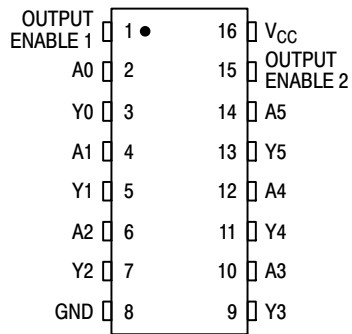

Figure 1. Pin Assignment

## FUNCTION TABLE

| Inputs   |          |   | Output |
|----------|----------|---|--------|
| Enable 1 | Enable 2 | A | Y      |
| L        | L        | L | L      |
| L        | L        | H | H      |
| H        | X        | X | Z      |
| X        | H        | X | Z      |

X = don't care

Z = high impedance

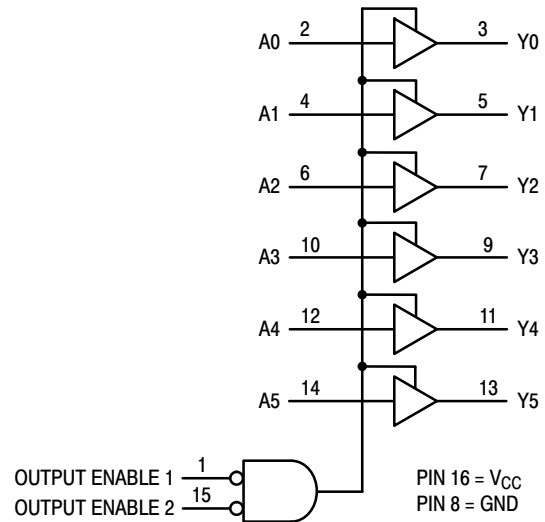

Figure 2. Logic Diagram

## ORDERING INFORMATION

| Device          | Package              | Shipping <sup>†</sup> |
|-----------------|----------------------|-----------------------|
| MC74HC365ANG    | PDIP-16<br>(Pb-Free) | 500 Units / Rail      |
| MC74HC365ADG    | SOIC-16<br>(Pb-Free) | 48 Units / Rail       |
| MC74HC365ADR2G  | SOIC-16<br>(Pb-Free) | 2500 Units / Reel     |
| MC74HC365ADTR2G | TSSOP-16*            | 2500 Units / Reel     |

<sup>†</sup>For information on tape and reel specifications, including part orientation and tape sizes, please refer to our Tape and Reel Packaging Specifications Brochure, BRD8011/D.

\*This package is inherently Pb-Free.

# MC74HC365A

## MAXIMUM RATINGS\*

| Symbol    | Parameter   | Value                   | Unit |
|-----------|---|-------------------------|------|
| $V_{CC}$  | DC Supply Voltage (Referenced to GND)   | - 0.5 to + 7.0          | V    |
| $V_{in}$  | DC Input Voltage (Referenced to GND)  | - 0.5 to $V_{CC} + 0.5$ | V    |
| $V_{out}$ | DC Output Voltage (Referenced to GND)   | - 0.5 to $V_{CC} + 0.5$ | V    |
| $I_{in}$  | DC Input Current, per Pin   | $\pm 20$                | mA   |
| $I_{out}$ | DC Output Current, per Pin  | $\pm 25$                | mA   |
| $I_{CC}$  | DC Supply Current, $V_{CC}$ and GND Pins  | $\pm 50$                | mA   |
| $P_D$     | Power Dissipation in Still Air,<br>Plastic DIP†<br>SOIC Package†<br>TSSOP Package†    | 750<br>500<br>450       | mW   |
| $T_{stg}$ | Storage Temperature   | - 65 to + 150           | °C   |
| $T_L$     | Lead Temperature, 1 mm from Case for 10 Seconds<br>Plastic DIP, SOIC or TSSOP Package | 260                     | °C   |

This device contains protection circuitry to guard against damage due to high static voltages or electric fields. However, precautions must be taken to avoid applications of any voltage higher than maximum rated voltages to this high-impedance circuit. For proper operation,  $V_{in}$  and  $V_{out}$  should be constrained to the range  $GND \leq (V_{in} \text{ or } V_{out}) \leq V_{CC}$ . Unused inputs must always be tied to an appropriate logic voltage level (e.g., either GND or  $V_{CC}$ ). Unused outputs must be left open.

Stresses exceeding Maximum Ratings may damage the device. Maximum Ratings are stress ratings only. Functional operation above the Recommended Operating Conditions is not implied. Extended exposure to stresses above the Recommended Operating Conditions may affect device reliability.

†Derating — Plastic DIP: - 10 mW/°C from 65° to 125°C  
SOIC Package: - 7 mW/°C from 65° to 125°C  
TSSOP Package: - 6.1 mW/°C from 65° to 125°C

## RECOMMENDED OPERATING CONDITIONS

| Symbol            | Parameter  | Min  | Max      | Unit |
|-------------------|--|------|----------|------|
| $V_{CC}$          | DC Supply Voltage (Referenced to GND)                | 2.0  | 6.0      | V    |
| $V_{in}, V_{out}$ | DC Input Voltage, Output Voltage (Referenced to GND) | 0    | $V_{CC}$ | V    |
| $T_A$             | Operating Temperature, All Package Types             | - 55 | + 125    | °C   |
| $t_r, t_f$        | Input Rise and Fall Time<br>(Figure 1)               |      |          | ns   |
|                   | $V_{CC} = 2.0 \text{ V}$                             | 0    | 1000     |      |
|                   | $V_{CC} = 3.0 \text{ V}$                             | 0    | 600      |      |
|                   | $V_{CC} = 4.5 \text{ V}$                             | 0    | 500      |      |
|                   | $V_{CC} = 6.0 \text{ V}$                             | 0    | 400      |      |

## DC ELECTRICAL CHARACTERISTICS (Voltages Referenced to GND)

| Symbol   | Parameter                         | Test Conditions   | $V_{CC}$<br>V                   | Guaranteed Limit |        |         | Unit |      |
|----------|-----------------------------------|---|---------------------------------|------------------|--------|---------|------|------|
|          |                                   |   |                                 | - 55 to<br>25°C  | ≤ 85°C | ≤ 125°C |      |      |
| $V_{IH}$ | Minimum High-Level Input Voltage  | $V_{out} = V_{CC} - 0.1 \text{ V}$<br>$ I_{out}  \leq 20 \mu\text{A}$ | 2.0                             | 1.5              | 1.5    | 1.5     | V    |      |
|          |                                   |   | 3.0                             | 2.1              | 2.1    | 2.1     |      |      |
|          |                                   |   | 4.5                             | 3.15             | 3.15   | 3.15    |      |      |
|          |                                   |   | 6.0                             | 4.2              | 4.2    | 4.2     |      |      |
| $V_{IL}$ | Maximum Low-Level Input Voltage   | $V_{out} = 0.1 \text{ V}$<br>$ I_{out}  \leq 20 \mu\text{A}$          | 2.0                             | 0.50             | 0.50   | 0.50    | V    |      |
|          |                                   |   | 3.0                             | 0.90             | 0.90   | 0.90    |      |      |
|          |                                   |   | 4.5                             | 1.35             | 1.35   | 1.35    |      |      |
|          |                                   |   | 6.0                             | 1.80             | 1.80   | 1.80    |      |      |
| $V_{OH}$ | Minimum High-Level Output Voltage | $V_{in} = V_{IH}$<br>$ I_{out}  \leq 20 \mu\text{A}$                  | 2.0                             | 1.9              | 1.9    | 1.9     | V    |      |
|          |                                   |   | 4.5                             | 4.4              | 4.4    | 4.4     |      |      |
|          |                                   |   | 6.0                             | 5.9              | 5.9    | 5.9     |      |      |
|          |                                   | $V_{in} = V_{IH}$   | $ I_{out}  \leq 3.6 \text{ mA}$ | 3.0              | 2.48   | 2.34    |      | 2.20 |
|          |                                   |   | $ I_{out}  \leq 6.0 \text{ mA}$ | 4.5              | 3.98   | 3.84    |      | 3.70 |
|          |                                   |   | $ I_{out}  \leq 7.8 \text{ mA}$ | 6.0              | 5.48   | 5.34    |      | 5.20 |

# MC74HC365A

## DC ELECTRICAL CHARACTERISTICS (Voltages Referenced to GND)

| Symbol          | Parameter                                      | Test Conditions   | V <sub>CC</sub><br>V | Guaranteed Limit |        |         | Unit |
|-----------------|--|---|----------------------|------------------|--------|---------|------|
|                 |  |   |                      | - 55 to<br>25°C  | ≤ 85°C | ≤ 125°C |      |
| V <sub>OL</sub> | Maximum Low-Level Output Voltage               | V <sub>in</sub> = V <sub>IL</sub><br> I <sub>out</sub>   ≤ 20 μA  | 2.0                  | 0.1              | 0.1    | 0.1     | V    |
|                 |  |   | 4.5                  | 0.1              | 0.1    | 0.1     |      |
|                 |  |   | 6.0                  | 0.1              | 0.1    | 0.1     |      |
|                 |  | V <sub>in</sub> = V <sub>IL</sub><br> I <sub>out</sub>   ≤ 3.6 mA<br> I <sub>out</sub>   ≤ 6.0 mA<br> I <sub>out</sub>   ≤ 7.8 mA   | 3.0                  | 0.26             | 0.33   | 0.40    |      |
|                 |  |   | 4.5                  | 0.26             | 0.33   | 0.40    |      |
|                 |  |   | 6.0                  | 0.26             | 0.33   | 0.40    |      |
| I <sub>in</sub> | Maximum Input Leakage Current                  | V <sub>in</sub> = V <sub>CC</sub> or GND  | 6.0                  | ± 0.1            | ± 1.0  | ± 1.0   | μA   |
| I <sub>OZ</sub> | Maximum Three-State Leakage Current            | Output in High-Impedance State<br>V <sub>in</sub> = V <sub>IL</sub> or V <sub>IH</sub><br>V <sub>out</sub> = V <sub>CC</sub> or GND | 6.0                  | ± 0.5            | ± 5.0  | ± 10    | μA   |
| I <sub>CC</sub> | Maximum Quiescent Supply Current (per Package) | V <sub>in</sub> = V <sub>CC</sub> or GND<br>I <sub>out</sub> = 0 μA   | 6.0                  | 4                | 40     | 160     | μA   |

## AC ELECTRICAL CHARACTERISTICS (C<sub>L</sub> = 50 pF, Input t<sub>r</sub> = t<sub>f</sub> = 6 ns)

| Symbol                                 | Parameter  | V <sub>CC</sub><br>V                    | Guaranteed Limit |        |         | Unit |
|--|--|---|------------------|--------|---------|------|
|  |  |   | - 55 to<br>25°C  | ≤ 85°C | ≤ 125°C |      |
| t <sub>PLH</sub> ,<br>t <sub>PHL</sub> | Maximum Propagation Delay, Input A to Output Y<br>(Figures 1 and 3)        | 2.0                                     | 120              | 150    | 180     | ns   |
|  |  | 3.0                                     | 60               | 75     | 90      |      |
|  |  | 4.5                                     | 24               | 30     | 36      |      |
|  |  | 6.0                                     | 20               | 26     | 31      |      |
| t <sub>PLZ</sub> ,<br>t <sub>PHZ</sub> | Maximum Propagation Delay, Output Enable to Output Y<br>(Figures 2 and 4)  | 2.0                                     | 220              | 275    | 330     | ns   |
|  |  | 3.0                                     | 110              | 140    | 170     |      |
|  |  | 4.5                                     | 44               | 55     | 66      |      |
|  |  | 6.0                                     | 37               | 47     | 56      |      |
| t <sub>PZL</sub> ,<br>t <sub>PZH</sub> | Maximum Propagation Delay, Output Enable to Output Y<br>(Figures 2 and 4)  | 2.0                                     | 220              | 275    | 330     | ns   |
|  |  | 3.0                                     | 110              | 140    | 170     |      |
|  |  | 4.5                                     | 44               | 55     | 66      |      |
|  |  | 6.0                                     | 37               | 47     | 56      |      |
| t <sub>TLH</sub> ,<br>t <sub>THL</sub> | Maximum Output Transition Time, Any Output<br>(Figures 1 and 3)            | 2.0                                     | 60               | 75     | 90      | ns   |
|  |  | 3.0                                     | 22               | 28     | 34      |      |
|  |  | 4.5                                     | 12               | 15     | 18      |      |
|  |  | 6.0                                     | 10               | 13     | 15      |      |
| C <sub>in</sub>                        | Maximum Input Capacitance  | —                                       | 10               | 10     | 10      | pF   |
| C <sub>out</sub>                       | Maximum Three-State Output Capacitance<br>(Output in High-Impedance State) | —                                       | 15               | 15     | 15      | pF   |
| C <sub>PD</sub>                        | Power Dissipation Capacitance (Per Buffer)*                                | Typical @ 25°C, V <sub>CC</sub> = 5.0 V |                  |        | pF      |      |
|  |  | 60                                      |                  |        |         |      |

\* Used to determine the no-load dynamic power consumption: P<sub>D</sub> = C<sub>PD</sub> V<sub>CC</sub><sup>2</sup>f + I<sub>CC</sub> V<sub>CC</sub>.

# MC74HC365A

## SWITCHING WAVEFORMS

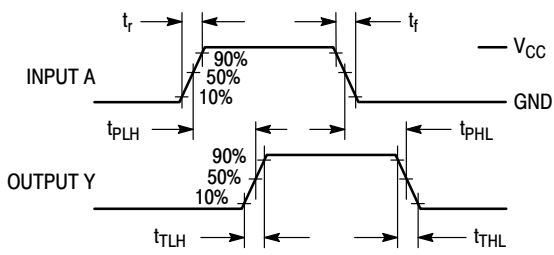

Figure 1.

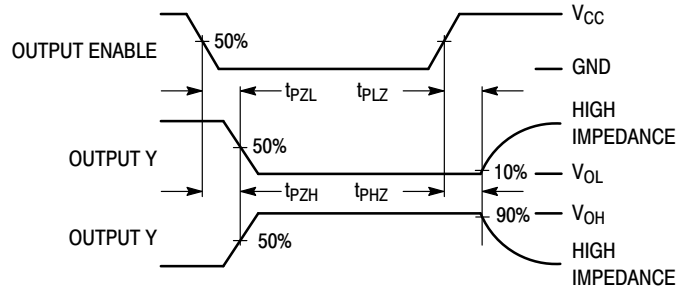
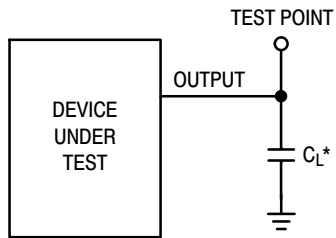

Figure 2.

## TEST CIRCUITS



\*Includes all probe and jig capacitance

Figure 3.

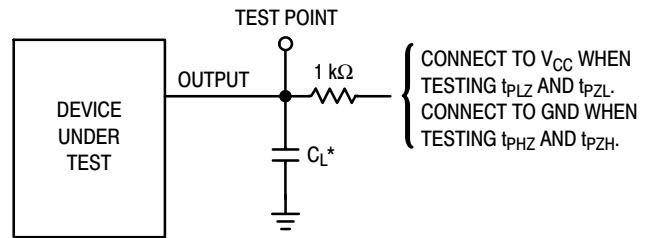

\*Includes all probe and jig capacitance

Figure 4.

## LOGIC DETAIL

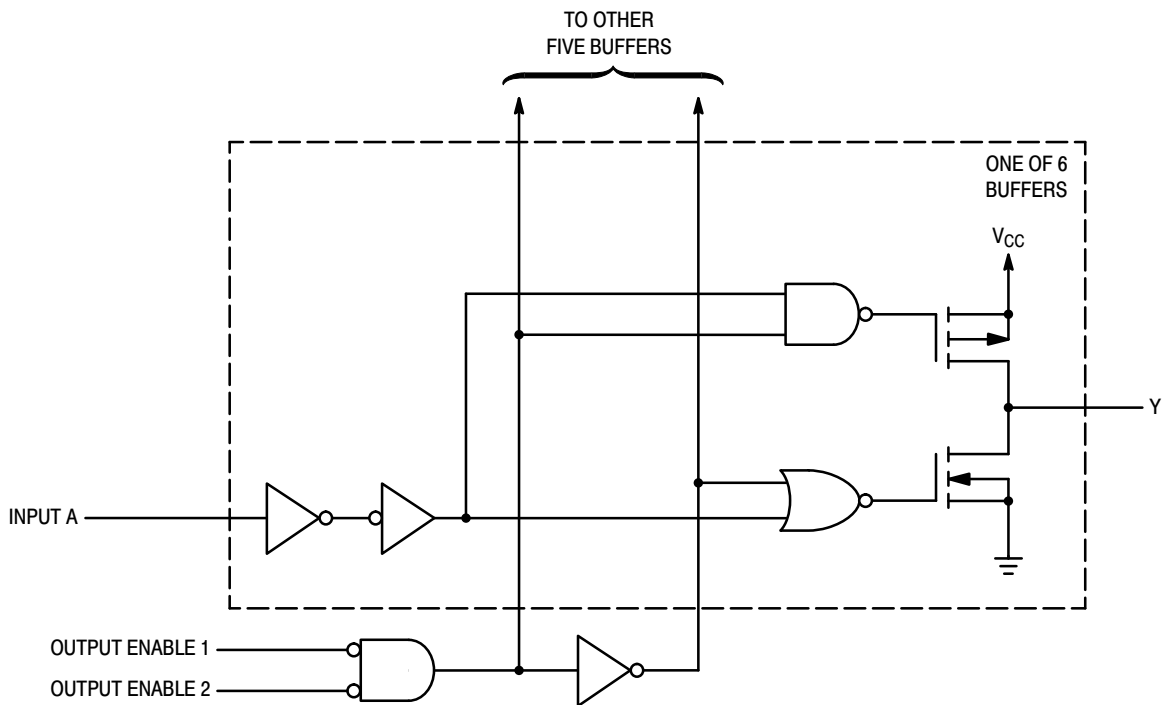

# MC74HC365A

## PACKAGE DIMENSIONS

### PDIP-16 N SUFFIX CASE 648-08 ISSUE T

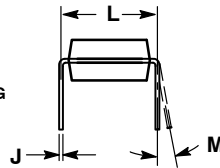
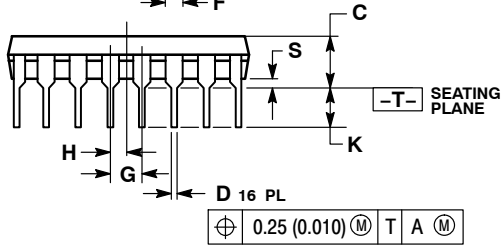
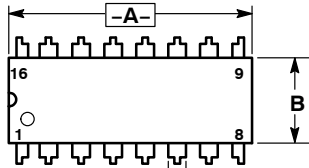

- NOTES:
1. DIMENSIONING AND TOLERANCING PER ANSI Y14.5M, 1982.
  2. CONTROLLING DIMENSION: INCH.
  3. DIMENSION L TO CENTER OF LEADS WHEN FORMED PARALLEL.
  4. DIMENSION B DOES NOT INCLUDE MOLD FLASH.
  5. ROUNDED CORNERS OPTIONAL.

| DIM | INCHES    |       | MILLIMETERS |       |
|-----|-----------|-------|-------------|-------|
|     | MIN       | MAX   | MIN         | MAX   |
| A   | 0.740     | 0.770 | 18.80       | 19.55 |
| B   | 0.250     | 0.270 | 6.35        | 6.85  |
| C   | 0.145     | 0.175 | 3.69        | 4.44  |
| D   | 0.015     | 0.021 | 0.39        | 0.53  |
| F   | 0.040     | 0.70  | 1.02        | 1.77  |
| G   | 0.100 BSC |       | 2.54 BSC    |       |
| H   | 0.050 BSC |       | 1.27 BSC    |       |
| J   | 0.008     | 0.015 | 0.21        | 0.38  |
| K   | 0.110     | 0.130 | 2.80        | 3.30  |
| L   | 0.295     | 0.305 | 7.50        | 7.74  |
| M   | 0°        | 10°   | 0°          | 10°   |
| S   | 0.020     | 0.040 | 0.51        | 1.01  |

### SOIC-16 D SUFFIX CASE 751B-05 ISSUE K

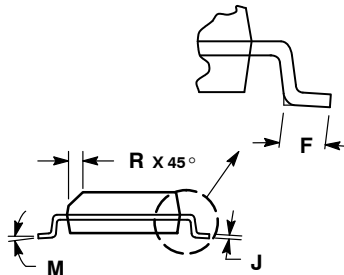
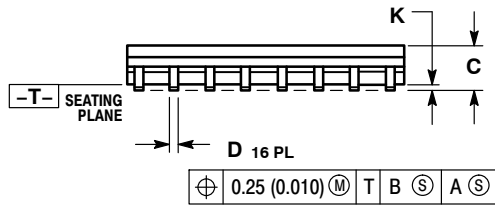
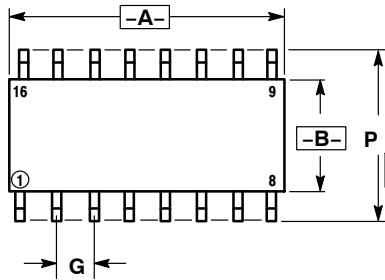

- NOTES:
1. DIMENSIONING AND TOLERANCING PER ANSI Y14.5M, 1982.
  2. CONTROLLING DIMENSION: MILLIMETER.
  3. DIMENSIONS A AND B DO NOT INCLUDE MOLD PROTRUSION.
  4. MAXIMUM MOLD PROTRUSION 0.15 (0.006) PER SIDE.
  5. DIMENSION D DOES NOT INCLUDE DAMBAR PROTRUSION. ALLOWABLE DAMBAR PROTRUSION SHALL BE 0.127 (0.005) TOTAL IN EXCESS OF THE D DIMENSION AT MAXIMUM MATERIAL CONDITION.

| DIM | MILLIMETERS |       | INCHES    |       |
|-----|-------------|-------|-----------|-------|
|     | MIN         | MAX   | MIN       | MAX   |
| A   | 9.80        | 10.00 | 0.386     | 0.393 |
| B   | 3.80        | 4.00  | 0.150     | 0.157 |
| C   | 1.35        | 1.75  | 0.054     | 0.068 |
| D   | 0.35        | 0.49  | 0.014     | 0.019 |
| F   | 0.40        | 1.25  | 0.016     | 0.049 |
| G   | 1.27 BSC    |       | 0.050 BSC |       |
| J   | 0.19        | 0.25  | 0.008     | 0.009 |
| K   | 0.10        | 0.25  | 0.004     | 0.009 |
| M   | 0°          | 7°    | 0°        | 7°    |
| P   | 5.80        | 6.20  | 0.229     | 0.244 |
| R   | 0.25        | 0.50  | 0.010     | 0.019 |

### SOLDERING FOOTPRINT

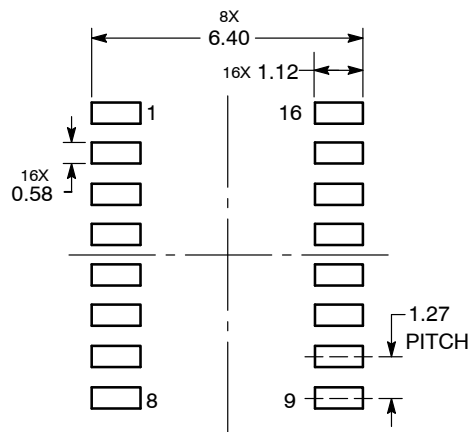

DIMENSIONS: MILLIMETERS

# MC74HC365A

## PACKAGE DIMENSIONS

TSSOP-16  
DT SUFFIX  
CASE 948F-01  
ISSUE B

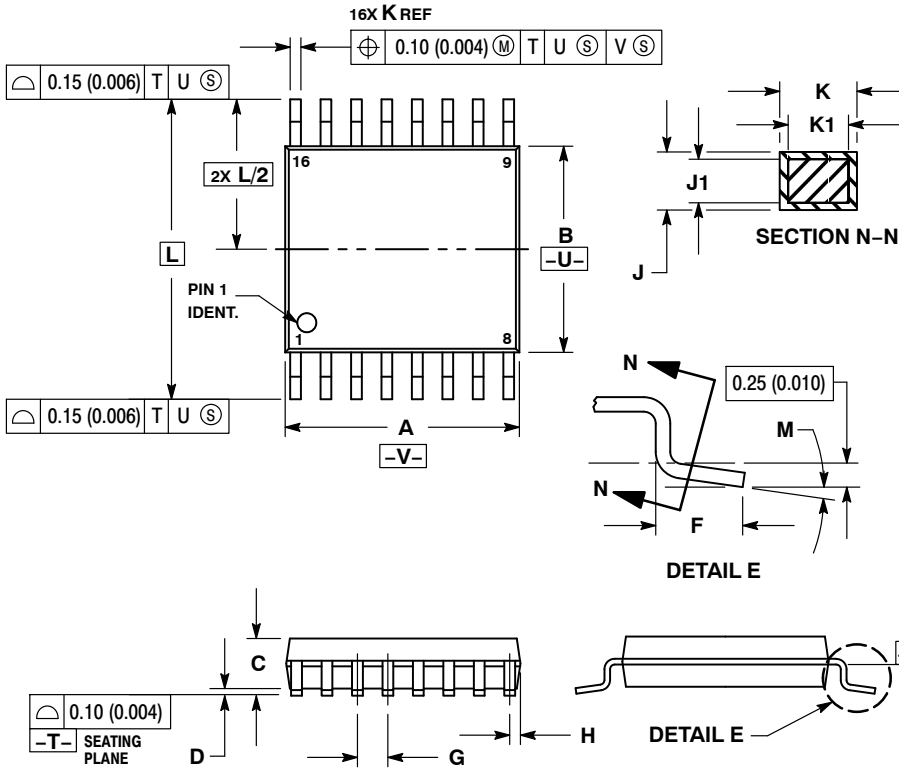

### NOTES:

1. DIMENSIONING AND TOLERANCING PER ANSI Y14.5M, 1982.
2. CONTROLLING DIMENSION: MILLIMETER.
3. DIMENSION A DOES NOT INCLUDE MOLD FLASH, PROTRUSIONS OR GATE BURRS. MOLD FLASH OR GATE BURRS SHALL NOT EXCEED 0.15 (0.006) PER SIDE.
4. DIMENSION B DOES NOT INCLUDE INTERLEAD FLASH OR PROTRUSION. INTERLEAD FLASH OR PROTRUSION SHALL NOT EXCEED 0.25 (0.010) PER SIDE.
5. DIMENSION K DOES NOT INCLUDE DAMBAR PROTRUSION. ALLOWABLE DAMBAR PROTRUSION SHALL BE 0.08 (0.003) TOTAL IN EXCESS OF THE K DIMENSION AT MAXIMUM MATERIAL CONDITION.
6. TERMINAL NUMBERS ARE SHOWN FOR REFERENCE ONLY.
7. DIMENSION A AND B ARE TO BE DETERMINED AT DATUM PLANE -W-.

| DIM | MILLIMETERS |      | INCHES    |       |
|-----|-------------|------|-----------|-------|
|     | MIN         | MAX  | MIN       | MAX   |
| A   | 4.90        | 5.10 | 0.193     | 0.200 |
| B   | 4.30        | 4.50 | 0.169     | 0.177 |
| C   | ---         | 1.20 | ---       | 0.047 |
| D   | 0.05        | 0.15 | 0.002     | 0.006 |
| F   | 0.50        | 0.75 | 0.020     | 0.030 |
| G   | 0.65 BSC    |      | 0.026 BSC |       |
| H   | 0.18        | 0.28 | 0.007     | 0.011 |
| J   | 0.09        | 0.20 | 0.004     | 0.008 |
| J1  | 0.09        | 0.16 | 0.004     | 0.006 |
| K   | 0.19        | 0.30 | 0.007     | 0.012 |
| K1  | 0.19        | 0.25 | 0.007     | 0.010 |
| L   | 6.40 BSC    |      | 0.252 BSC |       |
| M   | 0°          | 8°   | 0°        | 8°    |

### SOLDERING FOOTPRINT

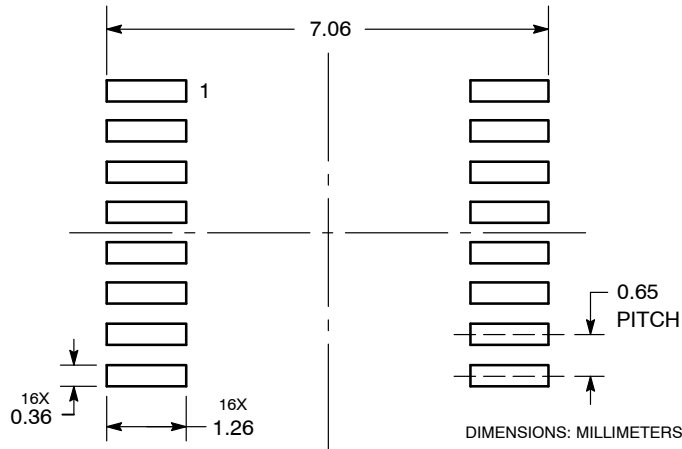

# MC74HC365A

**ON Semiconductor** and  are registered trademarks of Semiconductor Components Industries, LLC (SCILLC). SCILLC reserves the right to make changes without further notice to any products herein. SCILLC makes no warranty, representation or guarantee regarding the suitability of its products for any particular purpose, nor does SCILLC assume any liability arising out of the application or use of any product or circuit, and specifically disclaims any and all liability, including without limitation special, consequential or incidental damages. "Typical" parameters which may be provided in SCILLC data sheets and/or specifications can and do vary in different applications and actual performance may vary over time. All operating parameters, including "Typicals" must be validated for each customer application by customer's technical experts. SCILLC does not convey any license under its patent rights nor the rights of others. SCILLC products are not designed, intended, or authorized for use as components in systems intended for surgical implant into the body, or other applications intended to support or sustain life, or for any other application in which the failure of the SCILLC product could create a situation where personal injury or death may occur. Should Buyer purchase or use SCILLC products for any such unintended or unauthorized application, Buyer shall indemnify and hold SCILLC and its officers, employees, subsidiaries, affiliates, and distributors harmless against all claims, costs, damages, and expenses, and reasonable attorney fees arising out of, directly or indirectly, any claim of personal injury or death associated with such unintended or unauthorized use, even if such claim alleges that SCILLC was negligent regarding the design or manufacture of the part. SCILLC is an Equal Opportunity/Affirmative Action Employer. This literature is subject to all applicable copyright laws and is not for resale in any manner.

## PUBLICATION ORDERING INFORMATION

### LITERATURE FULFILLMENT:

Literature Distribution Center for ON Semiconductor  
P.O. Box 5163, Denver, Colorado 80217 USA  
**Phone:** 303-675-2175 or 800-344-3860 Toll Free USA/Canada  
**Fax:** 303-675-2176 or 800-344-3867 Toll Free USA/Canada  
**Email:** [orderlit@onsemi.com](mailto:orderlit@onsemi.com)

**N. American Technical Support:** 800-282-9855 Toll Free  
USA/Canada  
**Europe, Middle East and Africa Technical Support:**  
Phone: 421 33 790 2910  
**Japan Customer Focus Center**  
Phone: 81-3-5773-3850

**ON Semiconductor Website:** [www.onsemi.com](http://www.onsemi.com)

**Order Literature:** <http://www.onsemi.com/orderlit>

For additional information, please contact your local  
Sales Representative



Компания «Океан Электроники» предлагает заключение долгосрочных отношений при поставках импортных электронных компонентов на взаимовыгодных условиях!

Наши преимущества:

- Поставка оригинальных импортных электронных компонентов напрямую с производств Америки, Европы и Азии, а так же с крупнейших складов мира;
- Широкая линейка поставок активных и пассивных импортных электронных компонентов (более 30 млн. наименований);
- Поставка сложных, дефицитных, либо снятых с производства позиций;
- Оперативные сроки поставки под заказ (от 5 рабочих дней);
- Экспресс доставка в любую точку России;
- Помощь Конструкторского Отдела и консультации квалифицированных инженеров;
- Техническая поддержка проекта, помощь в подборе аналогов, поставка прототипов;
- Поставка электронных компонентов под контролем ВП;
- Система менеджмента качества сертифицирована по Международному стандарту ISO 9001;
- При необходимости вся продукция военного и аэрокосмического назначения проходит испытания и сертификацию в лаборатории (по согласованию с заказчиком);
- Поставка специализированных компонентов военного и аэрокосмического уровня качества (Xilinx, Altera, Analog Devices, Intersil, Interpoint, Microsemi, Actel, Aeroflex, Peregrine, VPT, Syfer, Eurofarad, Texas Instruments, MS Kennedy, Miteq, Cobham, E2V, MA-COM, Hittite, Mini-Circuits, General Dynamics и др.);

Компания «Океан Электроники» является официальным дистрибьютором и эксклюзивным представителем в России одного из крупнейших производителей разъемов военного и аэрокосмического назначения «JONHON», а так же официальным дистрибьютором и эксклюзивным представителем в России производителя высокотехнологичных и надежных решений для передачи СВЧ сигналов «FORSTAR».



## JONHON

«JONHON» (основан в 1970 г.)

Разъемы специального, военного и аэрокосмического назначения:

(Применяются в военной, авиационной, аэрокосмической, морской, железнодорожной, горно- и нефтедобывающей отраслях промышленности)

«FORSTAR» (основан в 1998 г.)

ВЧ соединители, коаксиальные кабели, кабельные сборки и микроволновые компоненты:

(Применяются в телекоммуникациях гражданского и специального назначения, в средствах связи, РЛС, а так же военной, авиационной и аэрокосмической отраслях промышленности).



Телефон: 8 (812) 309-75-97 (многоканальный)

Факс: 8 (812) 320-03-32

Электронная почта: [ocean@oceanchips.ru](mailto:ocean@oceanchips.ru)

Web: <http://oceanchips.ru/>

Адрес: 198099, г. Санкт-Петербург, ул. Калинина, д. 2, корп. 4, лит. А