

# Film Capacitors

## Metallized Polypropylene Film Capacitors (MKP)

**Series/Type:** B32674 ... B32678

**Date:** June 2018

© EPCOS AG 2018. Reproduction, publication and dissemination of this publication, enclosures hereto and the information contained therein without EPCOS' prior express consent is prohibited.

EPCOS AG is a TDK Group Company.

**MKP DC link – high power series****Typical applications**

- Frequency converters
- Industrial and high-end power supplies
- Solar inverters

**Climatic**

- Max. operating temperature: 105 °C (case)
- Climatic category (IEC 60068-1:2013):  
40/105/56

**Construction**

- Dielectric: Polypropylene (MKP)
- Plastic case (UL 94 V-0)
- Epoxy resin sealing (UL 94 V-0)

**Features**

- Capacitance value up to 270  $\mu$ F
- High CV product, compact
- Good self-healing properties
- Over-voltage capability
- Low losses with high current capability
- High reliability
- Long useful life
- AEC-Q200D compliant

**Terminals**

- Parallel wire leads, lead-free tinned
- 2-pin, 4-pin and 12-pin versions
- Standard lead lengths: 6 – 1 mm

**Marking**

Manufacturer's logo and lot number,  
date code, rated capacitance (coded),  
capacitance tolerance (code letter),  
rated DC voltage

**Delivery mode**

Bulk (untaped, lead length 6 – 1 mm)



## Dimensional drawings

Dimensions in mm

Number of wires	Lead spacing $e \pm 0.4$	Lead diameter $d_1 \pm 0.05$	Type
2-pin	27.5	0.8	B32674D
2-pin	37.5	1.0	B32676T
4-pin	37.5	1.2	B32676G
4-pin	37.5	1.2	B32676T
4-pin	52.5	1.2	B32678G
4-pin	52.5	1.2	B32678T
12-pin	52.5	1.2	B32678J

## Dimensional drawings 2-pin versions

### B32674D

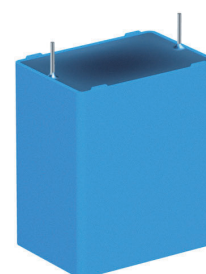
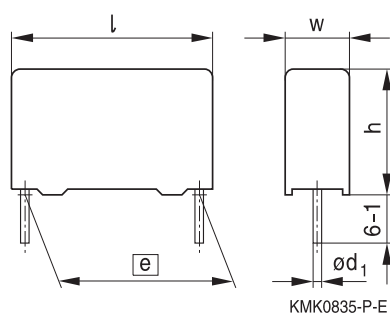

Lead spacing $e \pm 0.4$ :	27.5
Lead diameter $d_1$ :	0.8

(Dimensions in mm)

### B32676T (low profile)

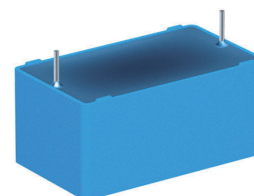
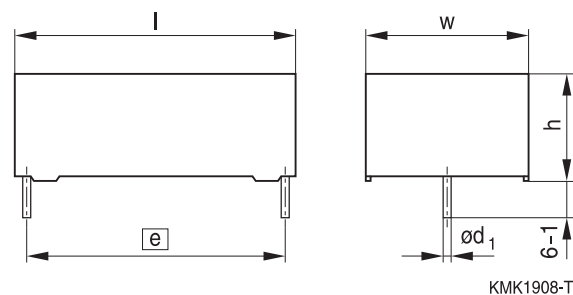

Lead spacing $e \pm 0.4$ :	37.5
Lead diameter $d_1$ :	1.0

(Dimensions in mm)



**B32674 ... B32678**

**MKP DC link – high power series**

**Dimensional drawings 4-pin versions**

**B32676G, B32678G**

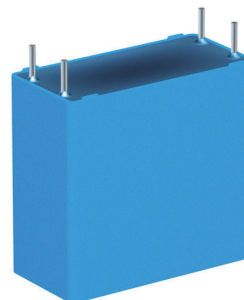
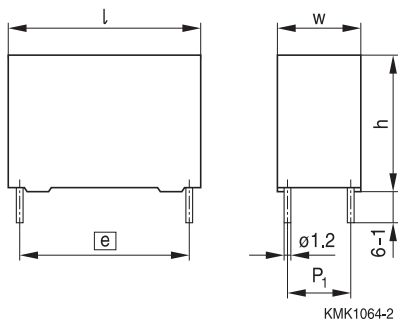

	B32676G	B32678G
Lead spacing $e \pm 0.4$ :	37.5	52.5
Lead diameter $d_1$ :	1.2	1.2

(Dimensions in mm)

**B32676T, B32678T (low profile)**

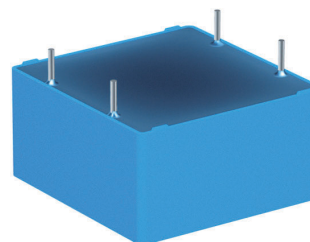
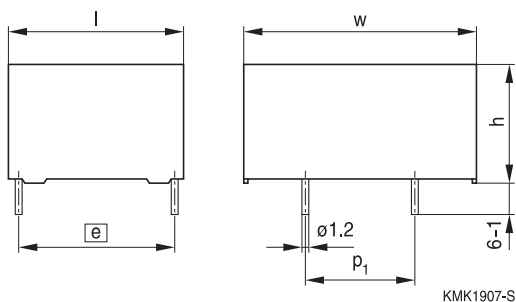

	B32676T	B32678T
Lead spacing $e \pm 0.4$ :	37.5	52.5
Lead diameter $d_1$ :	1.2	1.2

(Dimensions in mm)

**Dimensional drawing 12-pin version**

**B32678J**

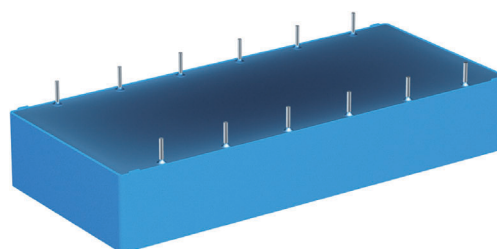
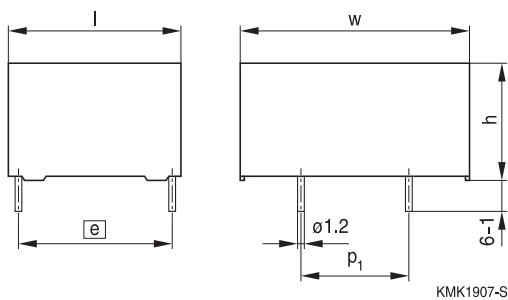

Lead spacing $e \pm 0.4$ :	52.5
Lead diameter $d_1$ :	1.2

(Dimensions in mm)

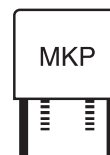

**Overview of available types**

Lead spacing	27.5 mm					37.5 mm				
Type	B32674					B32676				
Page	7					9				
V <sub>R</sub> (V DC)	300	450	630	750	875	300	450	630	750	875
C <sub>R</sub> (μF)										
0.47										
0.68										
1.0										
1.5										
2.0										
2.2										
2.7										
3.0										
3.3										
3.5										
4.0										
4.7										
5.0										
5.6										
6.0										
6.2										
6.8										
7.5										
8.0										
8.2										
9.0										
10										
12										
13										
14										
15										
20										
22										
25										
30										
35										



**B32674 ... B32678**

**MKP DC link – high power series**

**Overview of available types**

Lead spacing	52.5 mm				
Type	B32678				
Page	11				
$V_R$ (V DC)	300	450	630	750	875
$C_R$ ( $\mu$ F)					
7.0					
9.0					
13					
15					
20					
22					
24					
25					
28					
30					
35					
38					
40					
45					
47					
60					
65					
80					
85					
100					
120					
180					
270					

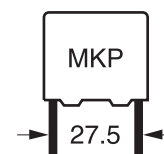
**Ordering codes and packing units (lead spacing 27.5 mm)**

$C_R^{1)}$ $\mu\text{F}$	Max. dimensions $w \times h \times l$ mm	$P_1$ mm	Ordering code (composition see below)	$I_{\text{RMS,max}}^{2)}$ 70 °C 10 kHz A	$\text{ESR}_{\text{typ}}$ 70 °C 10 kHz m $\Omega$	$\text{ESL}_{\text{typ}}^{3)}$ nH	$\tan \delta$ 1 kHz $10^{-3}$	$\tan \delta$ 10 kHz $10^{-3}$	pcs./ MOQ
<b><math>V_{\text{R,85 °C}} = 300 \text{ V DC}, V_{\text{op,70 °C}} = 450 \text{ V DC}</math></b>									
2.2	11.0 × 19.0 × 31.5	–	B32674D3225+000	5.0	18.1	16.0	0.7	4.1	1280
3.3	12.5 × 21.5 × 31.5	–	B32674D3335+000	7.0	12.2	19.0	0.7	4.1	1120
4.7	14.0 × 24.5 × 31.5	–	B32674D3475+000	8.5	8.9	21.0	0.7	4.2	1040
5.0	15.0 × 24.5 × 31.5	–	B32674D3505+000	9.0	8.4	21.0	0.7	4.2	960
6.8	18.0 × 27.5 × 31.5	–	B32674D3685+000	11.5	6.3	24.0	0.7	4.4	800
8.0	16.0 × 32.0 × 31.5	–	B32674D3805+000	12.5	5.6	27.0	0.7	4.5	880
8.2	18.0 × 33.0 × 31.5	–	B32674D3825+000	13.0	5.5	27.0	0.7	4.5	800
10.0	21.0 × 31.0 × 31.5	–	B32674D3106+000	14.5	4.6	27.0	0.8	4.6	720
12.0	22.0 × 36.5 × 31.5	–	B32674D3126+000	17.0	4.0	31.0	0.8	4.9	640
<b><math>V_{\text{R,85 °C}} = 450 \text{ V DC}, V_{\text{op,70 °C}} = 630 \text{ V DC}</math></b>									
1.5	11.0 × 19.0 × 31.5	–	B32674D4155+000	4.5	22.1	16.0	0.6	3.3	1280
2.2	12.5 × 21.5 × 31.5	–	B32674D4225+000	6.0	14.9	19.0	0.6	3.3	1120
3.3	15.0 × 24.5 × 31.5	–	B32674D4335+000	8.0	10.3	22.0	0.6	3.4	960
4.7	18.0 × 27.5 × 31.5	–	B32674D4475+000	10.5	7.5	24.0	0.6	3.5	800
5.0	16.0 × 32.0 × 31.5	–	B32674D4505+000	11.0	7.1	28.0	0.7	3.6	880
5.6	18.0 × 33.0 × 31.5	–	B32674D4565+000	12.0	6.3	29.0	0.7	3.6	800
6.0	21.0 × 31.0 × 31.5	–	B32674D4605+000	13.0	5.9	28.0	0.7	3.6	720
6.8	22.0 × 36.5 × 31.5	–	B32674D4685+000	14.5	5.4	29.0	0.7	3.7	640
7.5	22.0 × 36.5 × 31.5	–	B32674D4755+000	15.0	5.0	32.0	0.7	3.8	640
<b><math>V_{\text{R,85 °C}} = 630 \text{ V DC}, V_{\text{op,70 °C}} = 800 \text{ V DC}</math></b>									
1.0	11.0 × 19.0 × 31.5	–	B32674D6105+000	4.0	26.1	17.0	0.6	2.7	1280
1.5	12.5 × 21.5 × 31.5	–	B32674D6155+000	5.5	17.9	19.0	0.6	2.7	1120
2.2	15.0 × 24.5 × 31.5	–	B32674D6225+000	7.5	12.4	21.0	0.6	2.7	960
3.3	16.0 × 32.0 × 31.5	–	B32674D6335+000	10.0	8.5	28.0	0.6	2.8	880
4.7	22.0 × 36.5 × 31.5	–	B32674D6475+000	13.5	6.0	31.0	0.6	3.0	640
5.0	22.0 × 36.5 × 31.5	–	B32674D6505+000	14.5	5.8	31.0	0.6	3.0	640

MOQ = Minimum Order Quantity, consisting of 4 packing units.  
Intermediate capacitance values are available on request.

**Composition of ordering code**

+ = Capacitance tolerance code:

K =  $\pm 10\%$

J =  $\pm 5\%$

1) Capacitance value measured at 1 kHz

2) Max. ripple current  $I_{\text{RMS}}$  at 70 °C at 10 kHz for a  $\Delta T \leq 20$  °C when  $\Delta \text{ESR}_{\text{typ}} \leq \pm 5\%$

3) ESL value measured at resonance frequency (see specific graphs of Z versus frequency)



**B32674**

**MKP DC link – high power series**

**Ordering codes and packing units (lead spacing 27.5 mm)**

$C_R^{4)}$ $\mu\text{F}$	Max. dimensions $w \times h \times l$ mm	$P_1$ mm	Ordering code (composition see below)	$I_{\text{RMS,max}}^{5)}$ 70 °C 10 kHz A	$\text{ESR}_{\text{typ}}$ 70 °C 10 kHz m $\Omega$	$\text{ESL}_{\text{typ}}^{6)}$ nH	$\tan \delta$ 1 kHz $10^{-3}$	$\tan \delta$ 10 kHz $10^{-3}$	pcs./ MOQ
<b><math>V_{\text{R},85\text{ °C}} = 750 \text{ V DC}, V_{\text{op},70\text{ °C}} = 900 \text{ V DC}</math></b>									
0.68	11.0 × 19.0 × 31.5	–	B32674D1684+000	3.5	34.7	17.0	0.5	2.4	1280
1.0	12.5 × 21.5 × 31.5	–	B32674D1105+000	4.5	24.2	18.0	0.5	2.5	1120
1.5	14.0 × 24.5 × 31.5	–	B32674D1155+000	6.5	16.3	22.0	0.6	2.5	1040
2.2	18.0 × 27.5 × 31.5	–	B32674D1225+000	8.5	11.3	24.0	0.6	2.5	800
3.3	21.0 × 31.0 × 31.5	–	B32674D1335+000	11.0	7.9	28.0	0.6	2.6	720
4.0	22.0 × 36.5 × 31.5	–	B32674D1405+000	13.0	6.7	32.0	0.6	2.7	640
<b><math>V_{\text{R},85\text{ °C}} = 875 \text{ V DC}, V_{\text{op},70\text{ °C}} = 1050 \text{ V DC}</math></b>									
0.47	11.0 × 19.0 × 31.5	–	B32674D8474+000	3.0	45.2	16.0	0.5	2.2	1280
0.68	11.0 × 21.0 × 31.5	–	B32674D8684+000	4.0	31.5	19.0	0.5	2.2	1280
1.0	13.5 × 23.0 × 31.5	–	B32674D8105+000	5.0	22.2	20.0	0.5	2.2	1040
1.5	18.0 × 27.5 × 31.5	–	B32674D8155+000	7.5	14.7	23.0	0.5	2.2	800
2.2	18.0 × 33.0 × 31.5	–	B32674D8225+000	9.5	10.3	29.0	0.5	2.3	800
3.0	22.0 × 36.5 × 31.5	–	B32674D8305+000	12.0	7.8	31.0	0.5	2.4	640

MOQ = Minimum Order Quantity, consisting of 4 packing units.  
Intermediate capacitance values are available on request.

**Composition of ordering code**

+ = Capacitance tolerance code:

K = ±10%

J = ±5%

4) Capacitance value measured at 1 kHz

5) Max. ripple current  $I_{\text{RMS}}$  at 70 °C at 10 kHz for a  $\Delta T \leq 20\text{ °C}$  when  $\Delta \text{ESR}_{\text{typ}} \leq \pm 5\%$

6) ESL value measured at resonance frequency (see specific graphs of Z versus frequency)



**Ordering codes and packing units (lead spacing 37.5 mm)**

$C_R^{1)}$ $\mu\text{F}$	Max. dimensions $w \times h \times l$ mm	$P_1$ mm	Ordering code (composition see below)	$I_{\text{RMS,max}}^{2)}$ 70 °C 10 kHz A	$\text{ESR}_{\text{typ}}$ 70 °C 10 kHz m $\Omega$	$\text{ESL}_{\text{typ}}^{3)}$ nH	$\tan \delta$ 1 kHz $10^{-3}$	$\tan \delta$ 10 kHz $10^{-3}$	pcs./ MOQ
<b><math>V_{\text{R,85 °C}} = 300 \text{ V DC}, V_{\text{op,70 °C}} = 450 \text{ V DC}</math></b>									
6.2	24.0 × 15.0 × 41.5	—	B32676T3625+000	8.0	12.6	18.0	1.1	8.2	1040
9.0	24.0 × 19.0 × 41.5	—	B32676T3905+000	10.0	9.1	19.0	1.1	8.3	780
15.0	20.0 × 39.5 × 42.0	10.2	B32676G3156+000	16.0	5.4	10.0	1.1	8.3	640
20.0	28.0 × 37.0 × 42.0	10.2	B32676G3206+000	20.0	4.0	11.0	1.1	8.4	440
20.0	43.0 × 22.0 × 41.5	20.3	B32676T3206K000	19.5	4.0	13.0	1.1	8.3	280
22.0	28.0 × 42.5 × 42.0	10.2	B32676G3226+000	21.5	3.8	11.0	1.2	8.5	440
25.0	28.0 × 42.5 × 42.0	10.2	B32676G3256+000	22.5	3.4	12.0	1.2	8.6	440
30.0	30.0 × 45.0 × 42.0	20.3	B32676G3306+000	26.0	2.8	12.0	1.2	8.7	400
35.0	33.0 × 48.0 × 42.0	20.3	B32676G3356+000	29.5	2.5	13.0	1.2	8.8	180
<b><math>V_{\text{R,85 °C}} = 450 \text{ V DC}, V_{\text{op,70 °C}} = 630 \text{ V DC}</math></b>									
4.0	24.0 × 15.0 × 41.5	—	B32676T4405+000	7.0	15.5	19.0	1.0	6.6	1040
4.7	24.0 × 19.0 × 41.5	—	B32676T4475+000	8.0	13.2	18.0	1.0	6.6	780
8.2	20.0 × 39.5 × 42.0	10.2	B32676G4825+000	13.5	7.8	9.0	1.0	6.7	640
10.0	20.0 × 39.5 × 42.0	10.2	B32676G4106+000	14.5	6.4	11.0	1.0	6.7	640
13.0	43.0 × 22.0 × 41.5	20.3	B32676T4136K000	17.5	5.0	13.0	1.0	6.6	280
15.0	28.0 × 42.5 × 42.0	10.2	B32676G4156+000	20.0	4.4	11.0	1.0	6.8	440
20.0	30.0 × 45.0 × 42.0	20.3	B32676G4206K000	24.0	3.3	13.0	1.0	6.9	400
25.0	33.0 × 48.0 × 42.0	20.3	B32676G4256K000	28.0	2.8	14.0	1.0	7.1	180
<b><math>V_{\text{R,85 °C}} = 630 \text{ V DC}, V_{\text{op,70 °C}} = 800 \text{ V DC}</math></b>									
2.7	24.0 × 15.0 × 41.5	—	B32676T6275+000	7.0	17.7	20.0	0.8	5.1	1040
3.5	24.0 × 19.0 × 41.5	—	B32676T6355+000	8.0	14.1	19.0	0.8	5.1	780
6.8	20.0 × 39.5 × 42.0	10.2	B32676G6685+000	13.5	7.4	10.0	0.8	5.2	640
7.5	20.0 × 39.5 × 42.0	10.2	B32676G6755+000	14.5	6.6	12.0	0.8	5.2	640
8.2	28.0 × 37.0 × 42.0	10.2	B32676G6825+000	16.0	6.1	11.0	0.8	5.2	440
9.0	43.0 × 22.0 × 41.5	20.3	B32676T6905K000	16.5	5.7	13.0	0.8	5.1	280
10.0	28.0 × 42.5 × 42.0	10.2	B32676G6106+000	18.5	5.1	11.0	0.8	5.2	440
12.0	28.0 × 42.5 × 42.0	10.2	B32676G6126+000	20.0	4.4	12.0	0.8	5.3	440
14.0	30.0 × 45.0 × 42.0	20.3	B32676G6146+000	23.0	3.7	14.0	0.8	5.3	400
15.0	33.0 × 48.0 × 42.0	20.3	B32676G6156+000	25.0	3.5	14.0	0.8	5.4	180

MOQ = Minimum Order Quantity, consisting of 4 packing units.  
Intermediate capacitance values are available on request.

**Composition of ordering code**

+ = Capacitance tolerance code:

K =  $\pm 10\%$

J =  $\pm 5\%$

1) Capacitance value measured at 1 kHz

2) Max. ripple current  $I_{\text{RMS}}$  at 70 °C at 10 kHz for a  $\Delta T \leq 20$  °C when  $\Delta \text{ESR}_{\text{typ}} \leq \pm 5\%$

3) ESL value measured at resonance frequency (see specific graphs of Z versus frequency)

**B32676**
**MKP DC link – high power series**
**Ordering codes and packing units (lead spacing 37.5 mm)**

$C_R^{4)}$ $\mu\text{F}$	Max. dimensions $w \times h \times l$ mm	$P_1$ mm	Ordering code (composition see below)	$I_{\text{RMS,max}}^{5)}$ 70 °C 10 kHz A	$\text{ESR}_{\text{typ}}$ 70 °C 10 kHz mΩ	$\text{ESL}_{\text{typ}}^{6)}$ nH	$\tan \delta$ 1 kHz $10^{-3}$	$\tan \delta$ 10 kHz $10^{-3}$	pcs./ MOQ
<b><math>V_{\text{R},85\text{ °C}} = 750\text{ V DC}, V_{\text{op},70\text{ °C}} = 900\text{ V DC}</math></b>									
2.0	24.0 × 15.0 × 41.5	—	B32676T1205+000	6.0	22.7	18.0	0.8	4.6	1040
2.7	24.0 × 19.0 × 41.5	—	B32676T1275+000	7.5	16.7	19.0	0.8	4.6	780
4.7	20.0 × 39.5 × 42.0	10.2	B32676G1475+000	12.0	9.5	10.0	0.8	4.6	640
5.6	20.0 × 39.5 × 42.0	10.2	B32676G1565+000	13.0	8.2	11.0	0.8	4.7	640
6.8	28.0 × 37.0 × 42.0	10.2	B32676G1685+000	15.5	6.7	11.0	0.8	4.7	440
9.0	30.0 × 45.0 × 42.0	20.3	B32676G1905+000	19.5	5.1	12.0	0.8	4.7	440
10.0	30.0 × 45.0 × 42.0	20.3	B32676G1106+000	20.5	4.7	13.0	0.8	4.8	400
12.0	33.0 × 48.0 × 42.0	20.3	B32676G1126+000	23.0	4.0	14.0	0.8	4.8	180
<b><math>V_{\text{R},85\text{ °C}} = 875\text{ V DC}, V_{\text{op},70\text{ °C}} = 1050\text{ V DC}</math></b>									
1.5	24.0 × 15.0 × 41.5	—	B32676T8155+000	5.5	26.2	18.0	0.7	4.1	1040
2.0	24.0 × 19.0 × 41.5	—	B32676T8205+000	7.0	19.6	19.0	0.7	4.1	780
3.3	20.0 × 39.5 × 42.0	10.2	B32676G8335+000	10.5	12.0	9.0	0.7	4.1	640
4.0	20.0 × 39.5 × 42.0	10.2	B32676G8405+000	12.0	9.9	11.0	0.7	4.1	640
4.7	28.0 × 37.0 × 42.0	10.2	B32676G8475+000	13.5	8.6	10.0	0.7	4.1	440
6.8	28.0 × 42.5 × 42.0	10.2	B32676G8685+000	17.0	6.0	12.0	0.7	4.2	440
7.5	30.0 × 45.0 × 42.0	20.3	B32676G8755+000	19.0	5.4	13.0	0.7	4.2	400
10.0	33.0 × 48.0 × 42.0	20.3	B32676G8106K000	22.5	4.3	14.0	0.7	4.3	180

MOQ = Minimum Order Quantity, consisting of 4 packing units.  
Intermediate capacitance values are available on request.

**Composition of ordering code**

+ = Capacitance tolerance code:

K = ±10%

J = ±5%

4) Capacitance value measured at 1 kHz

5) Max. ripple current  $I_{\text{RMS}}$  at 70 °C at 10 kHz for a  $\Delta T \leq 20\text{ °C}$  when  $\Delta \text{ESR}_{\text{typ}} \leq \pm 5\%$

6) ESL value measured at resonance frequency (see specific graphs of Z versus frequency)

**Ordering codes and packing units (lead spacing 52.5 mm)**

$C_R^{1)}$ $\mu\text{F}$	Max. dimensions $w \times h \times l$ mm	$P_1$ mm	Ordering code (composition see below)	$I_{\text{RMS,max}}^{2)}$ 70 °C 10 kHz A	$\text{ESR}_{\text{typ}}$ 70 °C 10 kHz mΩ	$\text{ESL}_{\text{typ}}^{3)}$ nH	$\tan \delta$ 1 kHz $10^{-3}$	$\tan \delta$ 10 kHz $10^{-3}$	pcs./ MOQ
<b><math>V_{\text{R,85 °C}} = 300 \text{ V DC}, V_{\text{op,70 °C}} = 450 \text{ V DC}</math></b>									
30.0	43.0 × 24.0 × 57.5	20.3	B32678T3306K000	22.5	3.9	13.0	1.5	11.8	560
40.0	30.0 × 45.0 × 57.5	20.3	B32678G3406+000	28.0	3.0	12.0	1.5	12.3	280
47.0	35.0 × 50.0 × 57.5	20.3	B32678G3476+000	33.0	2.6	13.0	1.5	12.5	108
60.0	35.0 × 50.0 × 57.5	20.3	B32678G3606K000	37.0	2.1	15.0	1.6	12.9	108
80.0	45.0 × 57.0 × 57.5	20.3	B32678G3806+000	47.0	1.6	18.0	1.6	13.5	140
80.0	130.0 × 24.0 × 57.5	20.3	B32678J3806K000	51.0	1.4	4.0	1.5	11.7	80
100.0	60.0 × 45.0 × 57.5	20.3	B32678G3107+000	48.0	1.4	19.0	1.6	13.5	200
270.0	130.0 × 58.0 × 57.5	20.3	B32678J3277K000	108.0	0.5	6.0	1.6	13.8	40
<b><math>V_{\text{R,85 °C}} = 450 \text{ V DC}, V_{\text{op,70 °C}} = 630 \text{ V DC}</math></b>									
20.0	43.0 × 24.0 × 57.5	20.3	B32678T4206K000	20.0	4.9	13.0	1.3	9.8	560
30.0	35.0 × 50.0 × 57.5	20.3	B32678G4306+000	28.0	3.2	14.0	1.3	9.9	108
35.0	35.0 × 50.0 × 57.5	20.3	B32678G4356+000	31.5	2.8	14.0	1.3	10.0	108
40.0	35.0 × 50.0 × 57.5	20.3	B32678G4406K000	34.0	2.5	15.0	1.3	10.2	108
60.0	45.0 × 57.0 × 57.5	20.3	B32678G4606+000	45.0	1.8	18.0	1.4	11.2	140
60.0	130.0 × 24.0 × 57.5	20.3	B32678J4606K000	49.5	1.6	4.0	1.2	9.5	80
65.0	60.0 × 45.0 × 57.5	20.3	B32678G4656+000	48.0	1.6	19.0	1.3	10.6	200
180.0	130.0 × 58.0 × 57.5	20.3	B32678J4187K000	97.5	0.6	6.0	1.4	11.2	40
<b><math>V_{\text{R,85 °C}} = 630 \text{ V DC}, V_{\text{op,70 °C}} = 800 \text{ V DC}</math></b>									
13.0	43.0 × 24.0 × 57.5	20.3	B32678T6136K000	18.0	5.9	13.0	1.1	7.9	560
20.0	35.0 × 50.0 × 57.5	20.3	B32678G6206+000	26.5	4.0	13.0	1.1	8.2	108
25.0	35.0 × 50.0 × 57.5	20.3	B32678G6256+000	29.5	3.3	15.0	1.1	8.3	108
38.0	130.0 × 24.0 × 57.5	20.3	B32678J6386K000	43.5	2.1	4.0	1.1	7.9	80
40.0	45.0 × 57.0 × 57.5	20.3	B32678G6406+000	41.0	2.1	18.0	1.2	8.8	140
45.0	60.0 × 45.0 × 57.5	20.3	B32678G6456+000	43.0	1.9	19.0	1.2	8.7	200
120.0	130.0 × 58.0 × 57.5	20.3	B32678J6127K000	90.0	0.7	6.0	1.2	8.8	40

MOQ = Minimum Order Quantity, consisting of 4 packing units.  
Intermediate capacitance values are available on request.

**Composition of ordering code**

+ = Capacitance tolerance code:  
K = ±10%  
J = ±5%

1) Capacitance value measured at 1 kHz  
2) Max. ripple current  $I_{\text{RMS}}$  at 70 °C at 10 kHz for a  $\Delta T \leq 20$  °C when  $\Delta \text{ESR}_{\text{typ}} \leq \pm 5\%$   
3) ESL value measured at resonance frequency (see specific graphs of Z versus frequency)

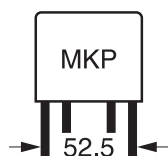
**B32678**
**MKP DC link – high power series**
**Ordering codes and packing units (lead spacing 52.5 mm)**

$C_R^{4)}$	Max. dimensions $w \times h \times l$	$P_1$	Ordering code (composition see below)	$I_{RMS,max}^{5)}$ 70 °C 10 kHz A	$ESR_{typ}$ 70 °C 10 kHz mΩ	$ESL_{typ}^{6)}$ nH	$\tan \delta$ 1 kHz $10^{-3}$	$\tan \delta$ 10 kHz $10^{-3}$	pcs./ MOQ
$\mu F$	mm	mm							
<b><math>V_{R,85\text{ °C}} = 750\text{ V DC}, V_{op,70\text{ °C}} = 900\text{ V DC}</math></b>									
9.0	43.0 × 24.0 × 57.5	20.3	B32678T1905K000	16.5	7.2	13.0	1.0	6.8	560
15.0	30.0 × 45.0 × 57.5	20.3	B32678G1156K000	23.0	4.5	14.0	1.0	7.0	280
20.0	35.0 × 50.0 × 57.5	20.3	B32678G1206K000	28.0	3.5	15.0	1.0	7.2	108
28.0	45.0 × 57.0 × 57.5	20.3	B32678G1286+000	37.5	2.5	18.0	1.0	7.4	140
30.0	60.0 × 45.0 × 57.5	20.3	B32678G1306+000	39.5	2.4	19.0	1.0	7.3	200
30.0	130.0 × 24.0 × 57.5	20.3	B32678J1306K000	40.5	2.3	4.0	1.0	6.8	80
85.0	130.0 × 58.0 × 57.5	20.3	B32678J1856K000	82.5	0.9	6.0	1.0	7.4	40
<b><math>V_{R,85\text{ °C}} = 875\text{ V DC}, V_{op,70\text{ °C}} = 1050\text{ V DC}</math></b>									
7.0	43.0 × 24.0 × 57.5	20.3	B32678T8705K000	15.5	8.2	13.0	0.9	6.0	560
15.0	35.0 × 50.0 × 57.5	20.3	B32678G8156K000	26.5	4.0	15.0	0.9	6.3	108
22.0	45.0 × 57.0 × 57.5	20.3	B32678G8226+000	35.0	2.9	17.0	1.0	6.5	140
22.0	130.0 × 24.0 × 57.5	20.3	B32678J8226K000	39.0	2.6	5.0	0.9	6.0	80
24.0	60.0 × 45.0 × 57.5	20.3	B32678G8246+000	38.0	2.6	19.0	0.9	6.4	200
65.0	130.0 × 58.0 × 57.5	20.3	B32678J8656K000	78.0	1.0	6.0	1.0	6.5	40

MOQ = Minimum Order Quantity, consisting of 4 packing units.  
Intermediate capacitance values are available on request.

**Composition of ordering code**

+ = Capacitance tolerance code:

K = ±10%

J = ±5%

4) Capacitance value measured at 1 kHz

5) Max. ripple current  $I_{RMS}$  at 70 °C at 10 kHz for a  $\Delta T \leq 20\text{ °C}$  when  $\Delta ESR_{typ} \leq \pm 5\%$

6) ESL value measured at resonance frequency (see specific graphs of Z versus frequency)

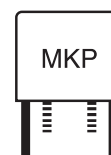

### Technical data

Reference standard: IEC 61071:2007 and AEC-Q200D. All data given at  $T = 20\text{ °C}$ , unless otherwise specified.

Rated temperature $T_R$	+85 °C				
Operating temperature range (case)	Max. operating temperature, $T_{op,max}$	+105 °C			
	Upper category temperature $T_{max}$	+105 °C			
	Lower category temperature $T_{min}$	-40 °C			
Insulation resistance $R_{ins}$ given as time constant $\tau = C_R \cdot R_{ins}$ , rel. humidity $\leq 65\%$ (minimum as-delivered values)	$\tau > 10000\text{ s}$ (after 1 min) For $V_R \geq 500\text{ V}$ measured at 500 V For $V_R < 500\text{ V}$ measured at $V_R$				
DC voltage test between terminals (10 s)	$1.5 \cdot V_R$				
Voltage test terminal to case (10 s)	2110 V AC, 50 Hz				
Pulse Handling Capability (V/ $\mu$ s)	$I_P$ (A) / C ( $\mu$ F)				
Biased humidity Limit values after test	1000 hours / 40 °C / 93% relative humidity with $V_{R,DC}$ Capacitance change $ \Delta C/C  \leq 5\%$ Dissipation factor change $\Delta \tan \delta \leq 0.002$ (at 1 kHz) Insulation resistance $R_{ins} \geq 50\%$ of minimum as-delivered values				
Reliability:	Failure rate $\lambda$	1 fit ( $\leq 1 \cdot 10^{-9}/h$ ) at $0.5 \cdot V_R$ , 40 °C			
	Service life $t_{SL}$	200 000 h at $V_R$ , 85 °C			
		For conversion to other operating conditions and temperatures, refer to chapter "Quality, 2 Reliability".			
$V_R$ (V DC)	300	450	630	750	875
Continuous operation voltage $V_{op}$ (V DC) at 70 °C	450	630	800	900	1050
Continuous operation voltage $V_{op}$ (V DC) at 85 °C	300	450	630	750	875
For temperatures between 85 °C and 100 °C	1.2%/°C of $V_{op}$ derating compared to $V_{op}$ at 85 °C				

### Typical waveforms

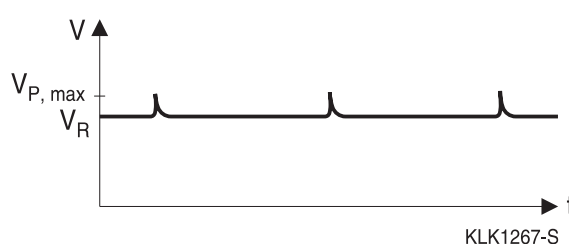
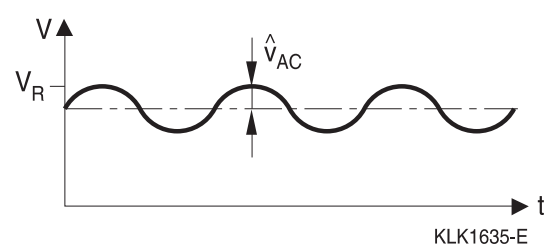

### Restrictions:

**$V_R$ :** Maximum operating peak voltage of either polarity but of a non-reversing waveform, for which the capacitor has been designed for continuous operation.

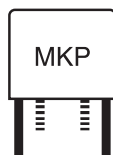

B32674 ... B32678

MKP DC link – high power series

$$\hat{u}_{AC} \leq 0.2 \cdot V_R$$

$$V_{p, max}$$

Overvoltage	Maximum duration within one day	Observation
$1.1 \cdot V_R$	30% of on-load duration	System regulation
$1.15 \cdot V_R$	30 min.	System regulation
$1.2 \cdot V_R$	5 min.	System regulation
$1.3 \cdot V_R$	1 min.	System regulation

NOTE 1 An overvoltage equal to  $1.5 \cdot V_R$  for 30 ms is permitted 1000 times during the life of the capacitor.

The amplitudes of the overvoltages that may be tolerated without significant reduction in the life time of the capacitor depend on their duration, the number of application and the capacitor temperature.

In addition these values assume that the overvoltages may appear when the internal temperature of the capacitor is less than 0 °C but within the temperature category.

NOTE 2 The average applied voltage must not be higher than the specified voltage.

### Pulse handling capability

"dV/dt" represents the maximum permissible voltage change per unit of time for non-sinusoidal voltages, expressed in V/μs.

Note:

The values of dV/dt and  $k_0$  provided below must not be exceeded in order to avoid damaging the capacitor. These parameters are given for isolated pulses in such a way that the heat generated by one pulse will be completely dissipated before applying the next pulse. For a train of pulses, please refer to the curves of permissible AC voltage-current versus frequency.

### dV/dt values

Lead spacing	27.5 mm					37.5 mm					52.5 mm				
Type	B32674					B32676					B32678				
$V_R$ (V DC)	300	450	630	750	875	300	450	630	750	875	300	450	630	750	875
dV/dt in V/μs	40	75	100	125	150	22	54	73	85	100	15	35	50	60	70



**Characteristics curves**

Additional technical information can be found under "Design support" on [www.epcos.com](http://www.epcos.com).

**Impedance Z versus frequency f**  
(typical values)

Lead spacing 27.5 mm

300 V DC

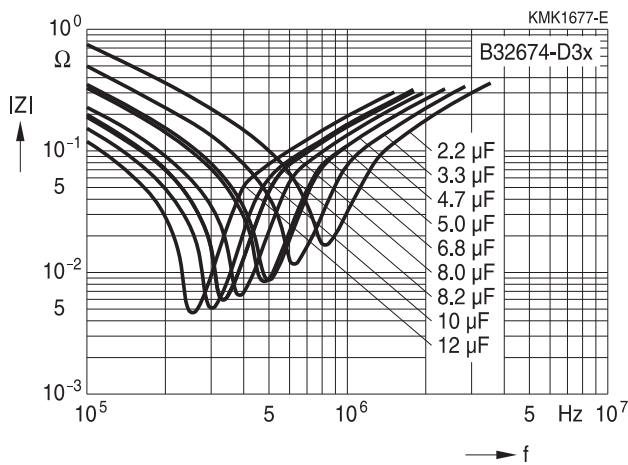

**ESR versus frequency f**  
(typical values)

Lead spacing 27.5 mm

300 V DC

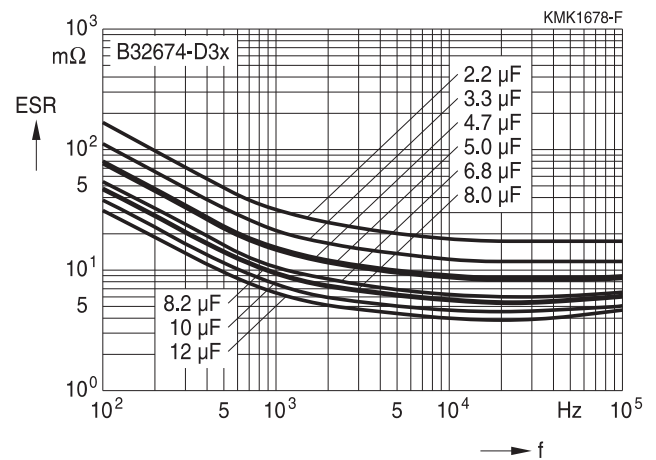

**Impedance Z versus frequency f**  
(typical values)

Lead spacing 27.5 mm

450 V DC

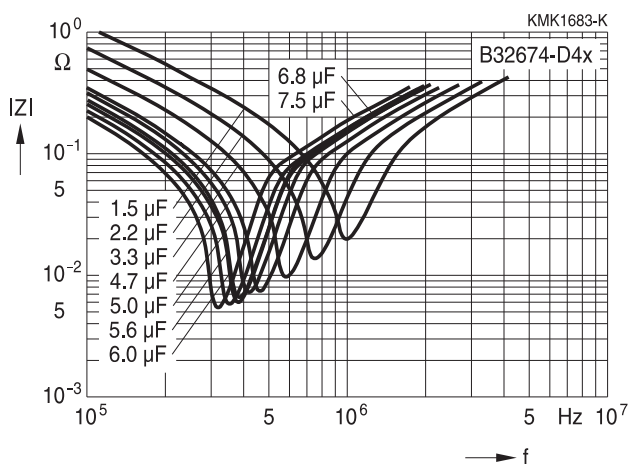

**ESR versus frequency f**  
(typical values)

Lead spacing 27.5 mm

450 V DC

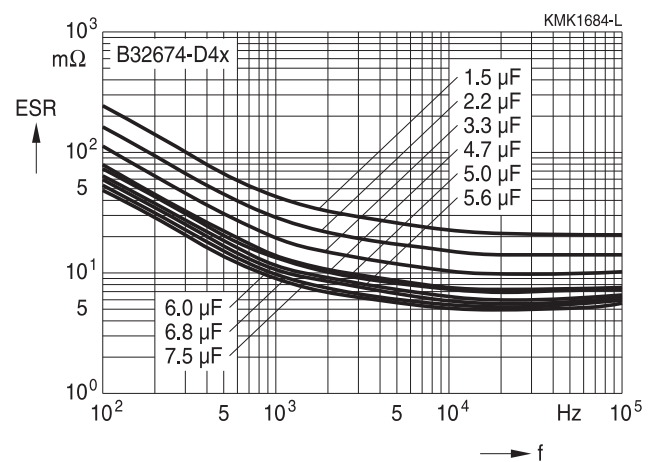



**B32674**

**MKP DC link – high power series**

**Characteristics curves**

Additional technical information can be found under "Design support" on [www.epcos.com](http://www.epcos.com).

**Impedance Z versus frequency f**  
(typical values)

**Lead spacing 27.5 mm**

**630 V DC**

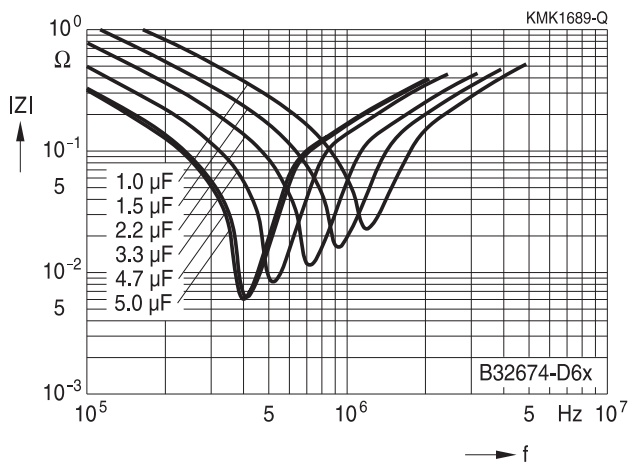

**ESR versus frequency f**  
(typical values)

**Lead spacing 27.5 mm**

**630 V DC**

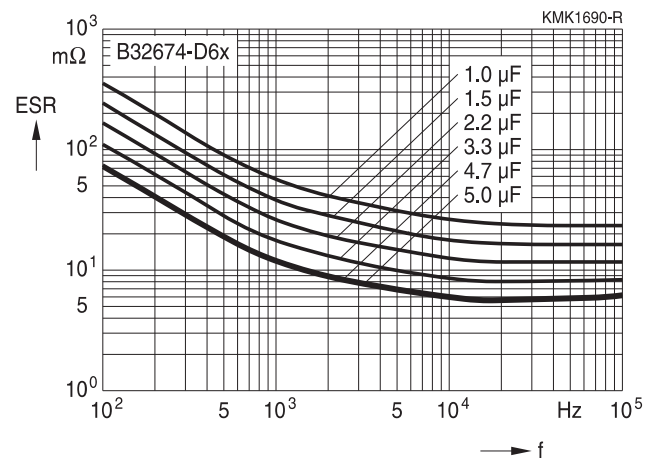

**Impedance Z versus frequency f**  
(typical values)

**Lead spacing 27.5 mm**

**750 V DC**

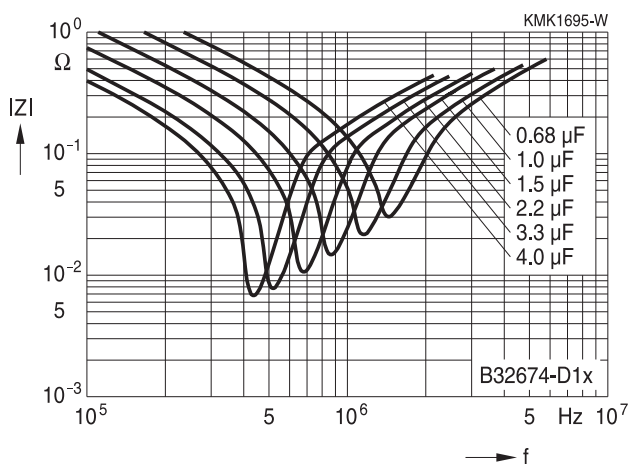

**ESR versus frequency f**  
(typical values)

**Lead spacing 27.5 mm**

**750 V DC**

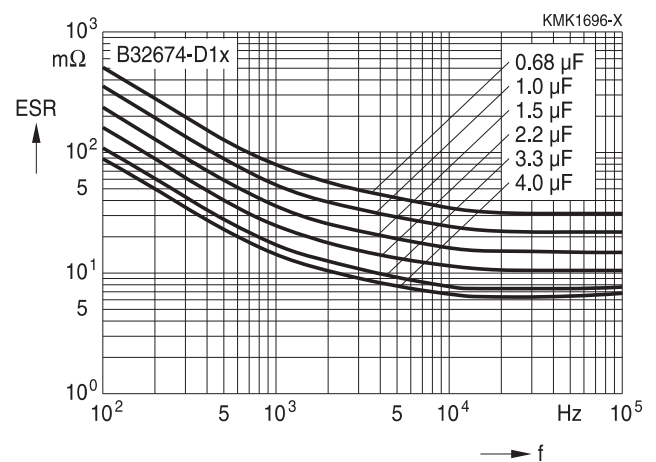



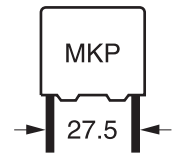

**Characteristics curves**

Additional technical information can be found under "Design support" on [www.epcos.com](http://www.epcos.com).

**Impedance Z versus frequency f**  
(typical values)

Lead spacing 27.5 mm

875 V DC

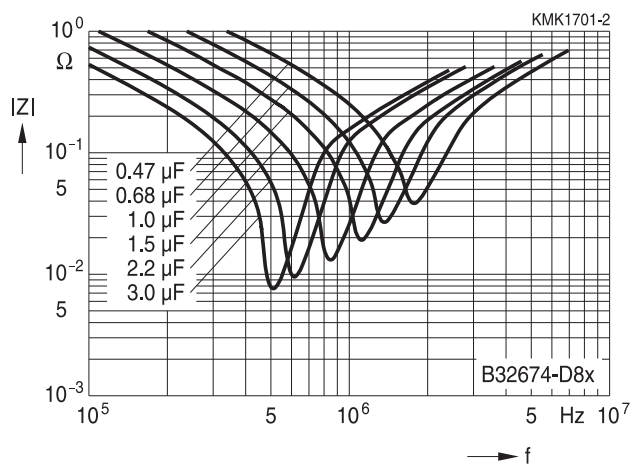

**ESR versus frequency f**  
(typical values)

Lead spacing 27.5 mm

875 V DC

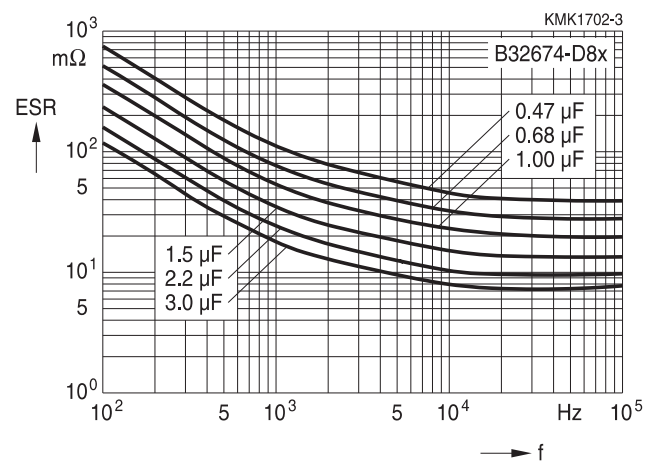

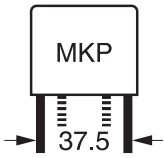

**B32676**

**MKP DC link – high power series**

**Characteristics curves**

Additional technical information can be found under "Design support" on [www.epcos.com](http://www.epcos.com).

**Impedance Z versus frequency f**  
(typical values)

**Lead spacing 37.5 mm**

**300 V DC**

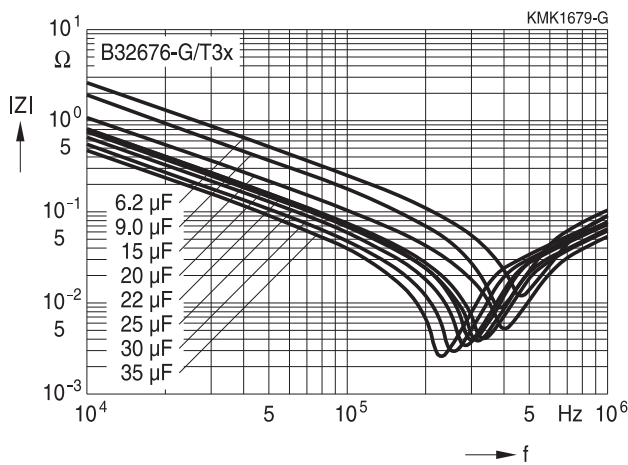

**ESR versus frequency f**  
(typical values)

**Lead spacing 37.5 mm**

**300 V DC**

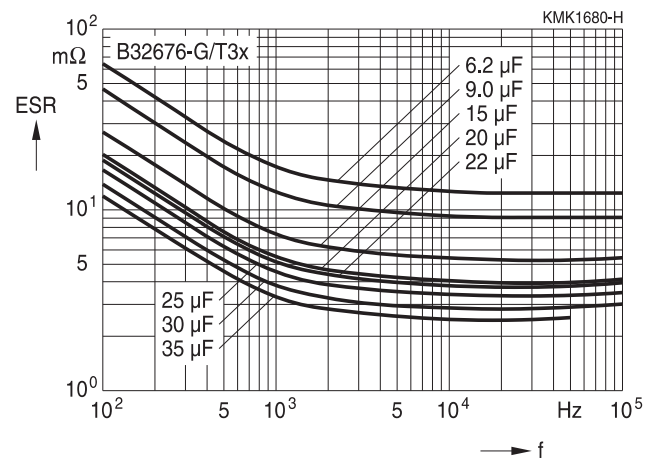

**Impedance Z versus frequency f**  
(typical values)

**Lead spacing 37.5 mm**

**450 V DC**

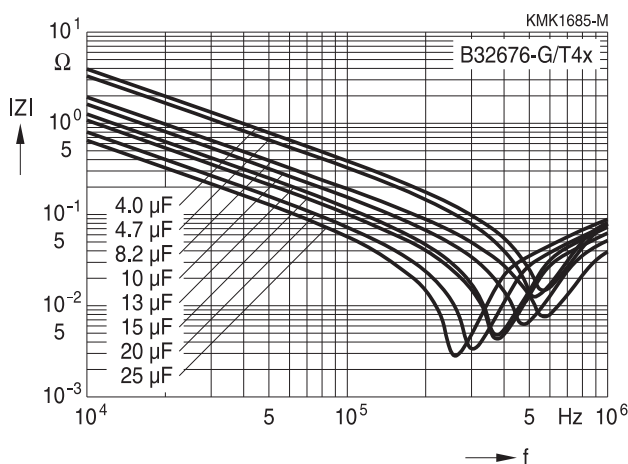

**ESR versus frequency f**  
(typical values)

**Lead spacing 37.5 mm**

**450 V DC**

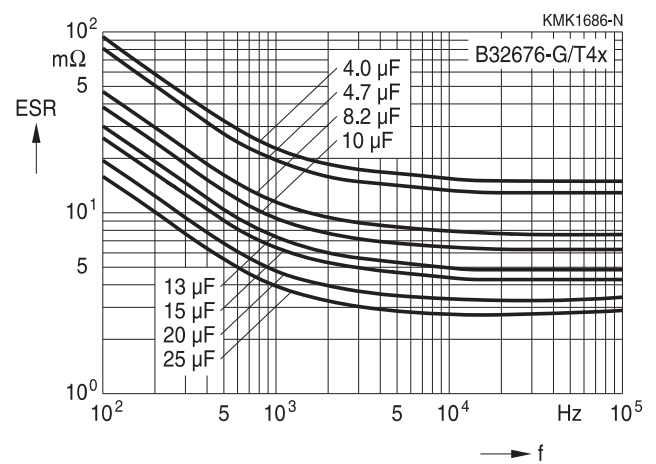

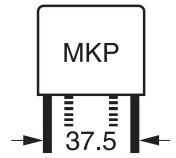

**Characteristics curves**

Additional technical information can be found under "Design support" on [www.epcos.com](http://www.epcos.com).

**Impedance Z versus frequency f**  
(typical values)

**Lead spacing 37.5 mm**

630 V DC

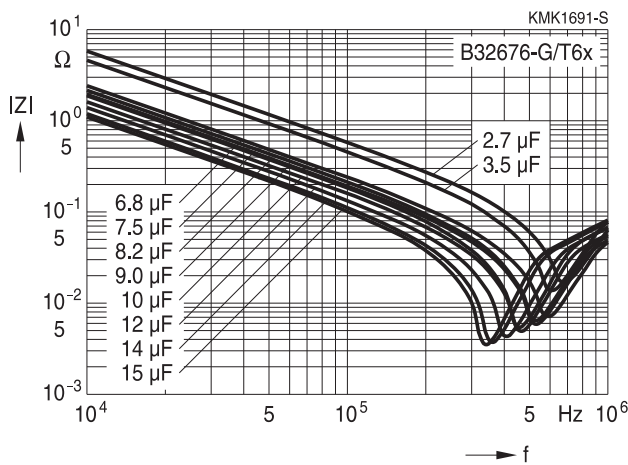

**ESR versus frequency f**  
(typical values)

**Lead spacing 37.5 mm**

630 V DC

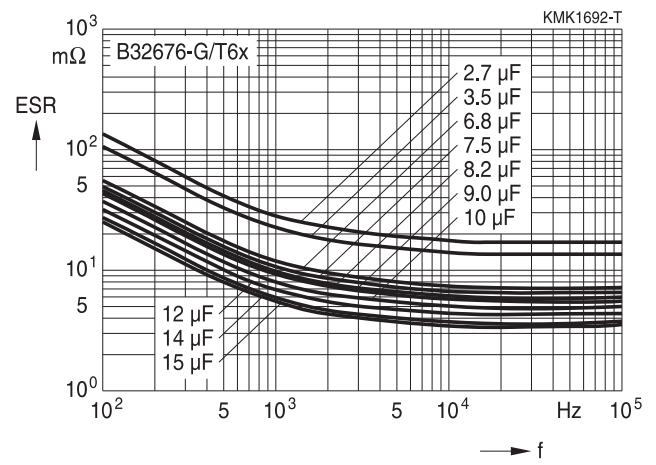

**Impedance Z versus frequency f**  
(typical values)

**Lead spacing 37.5 mm**

750 V DC

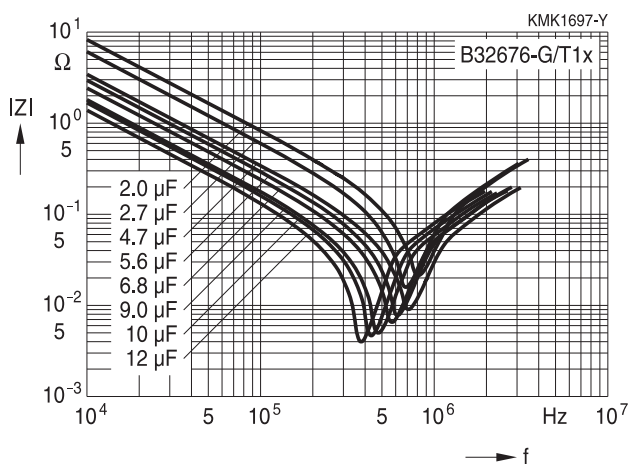

**ESR versus frequency f**  
(typical values)

**Lead spacing 37.5 mm**

750 V DC

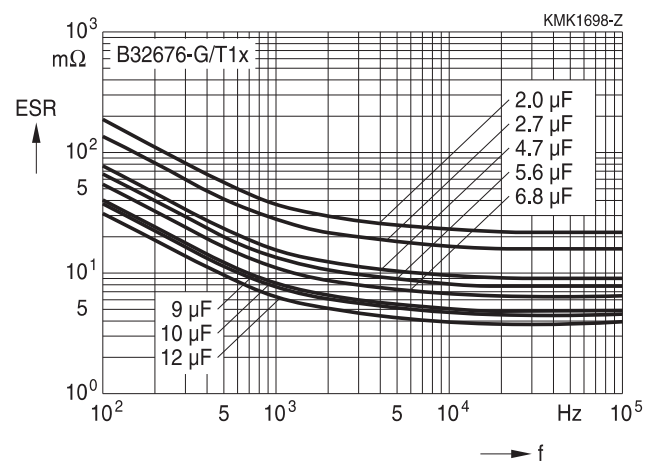



**B32676**

**MKP DC link – high power series**

**Characteristics curves**

Additional technical information can be found under "Design support" on [www.epcos.com](http://www.epcos.com).

**Impedance Z versus frequency f**  
(typical values)

**Lead spacing 37.5 mm**

**875 V DC**

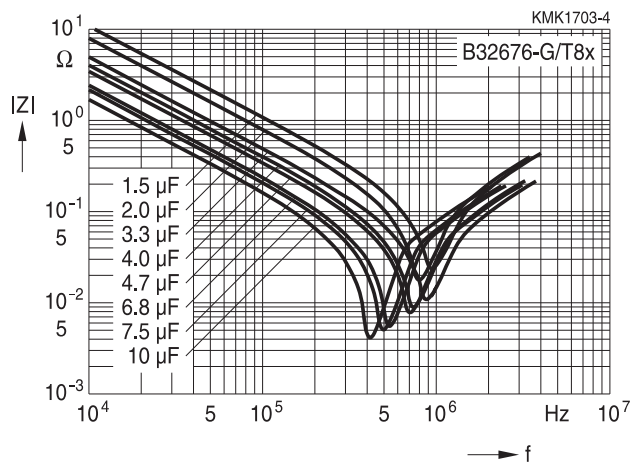

**ESR versus frequency f**  
(typical values)

**Lead spacing 37.5 mm**

**875 V DC**

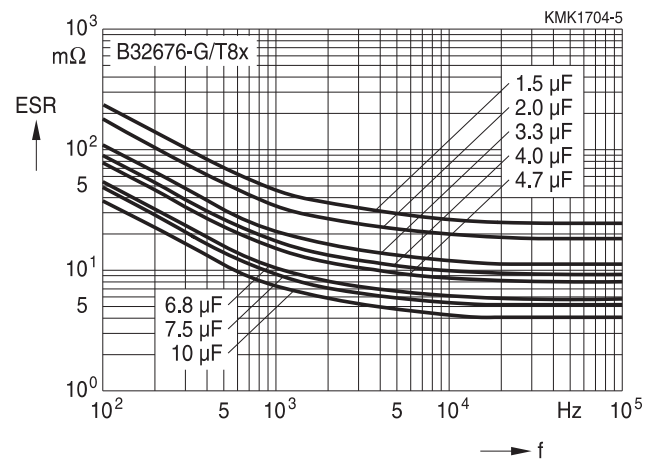

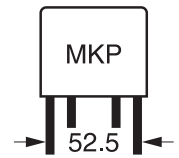

**Characteristics curves**

Additional technical information can be found under "Design support" on [www.epcos.com](http://www.epcos.com).

**Impedance Z versus frequency f**  
(typical values)

Lead spacing 52.5 mm

300 V DC

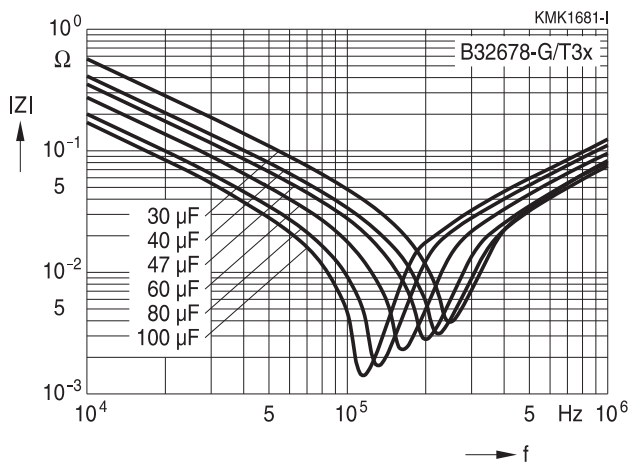

**ESR versus frequency f**  
(typical values)

Lead spacing 52.5 mm

300 V DC

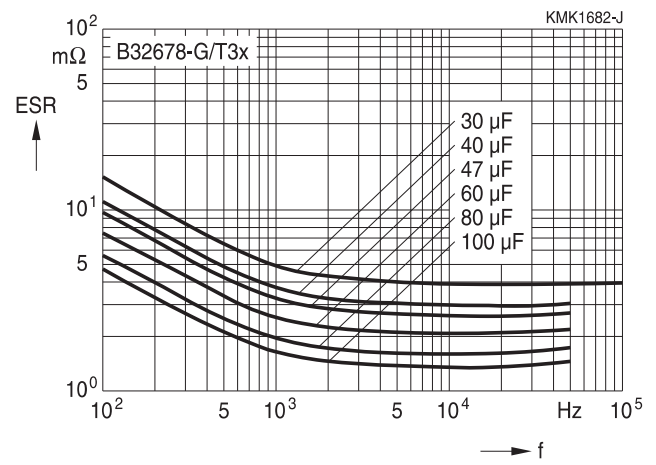

**Impedance Z versus frequency f**  
(typical values)

Lead spacing 52.5 mm

450 V DC

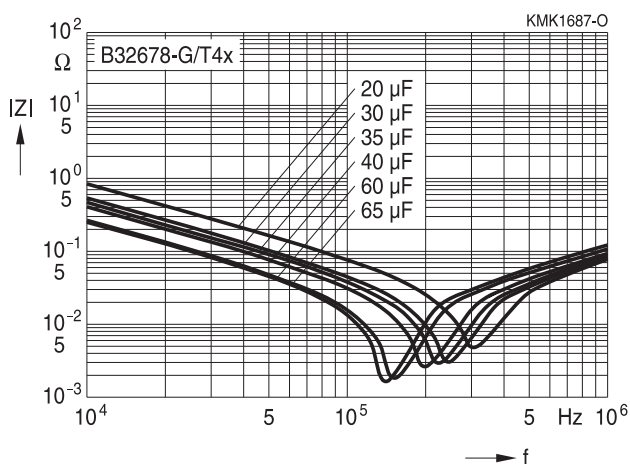

**ESR versus frequency f**  
(typical values)

Lead spacing 52.5 mm

450 V DC

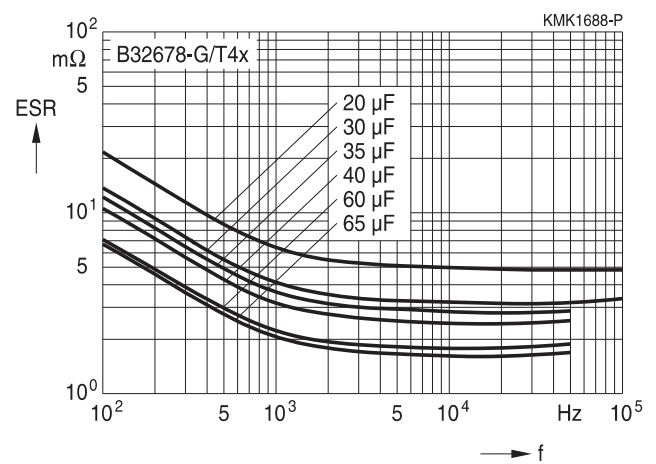

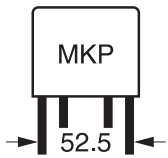

**B32678**

**MKP DC link – high power series**

**Characteristics curves**

Additional technical information can be found under "Design support" on [www.epcos.com](http://www.epcos.com).

**Impedance Z versus frequency f**  
(typical values)

**Lead spacing 52.5 mm**

**630 V DC**

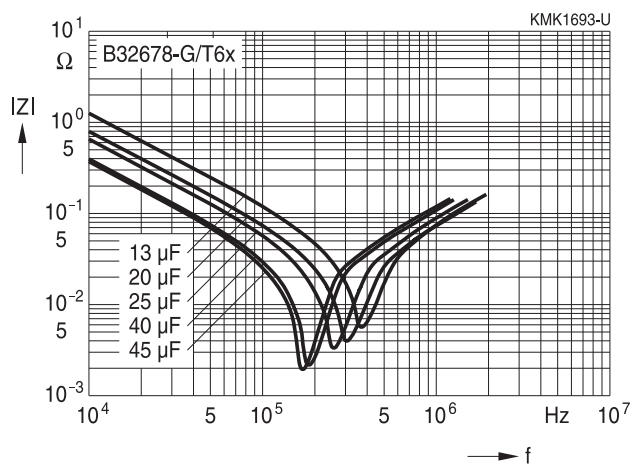

**ESR versus frequency f**  
(typical values)

**Lead spacing 52.5 mm**

**630 V DC**

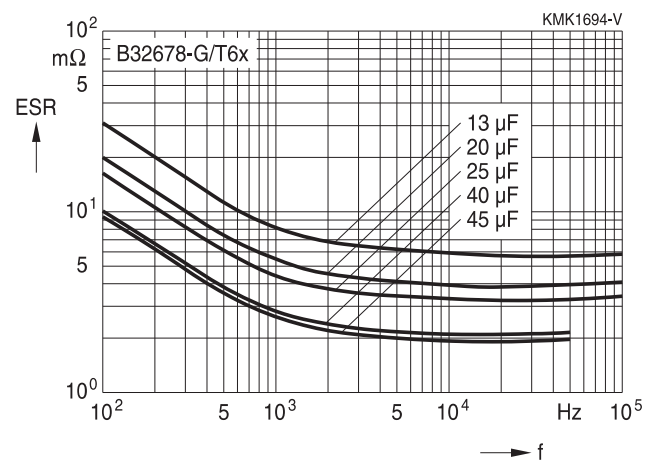

**Impedance Z versus frequency f**  
(typical values)

**Lead spacing 52.5 mm**

**750 V DC**

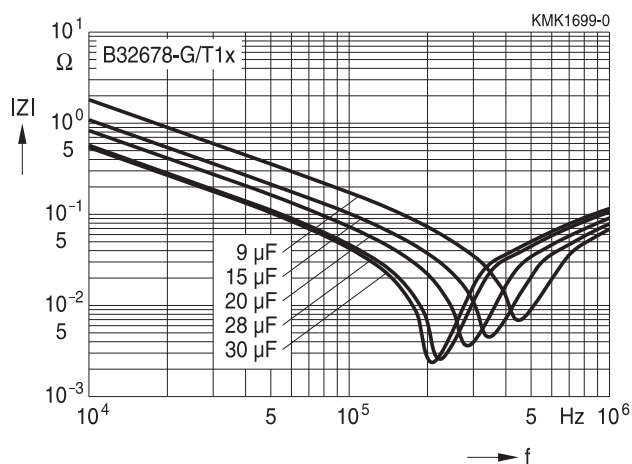

**ESR versus frequency f**  
(typical values)

**Lead spacing 52.5 mm**

**750 V DC**

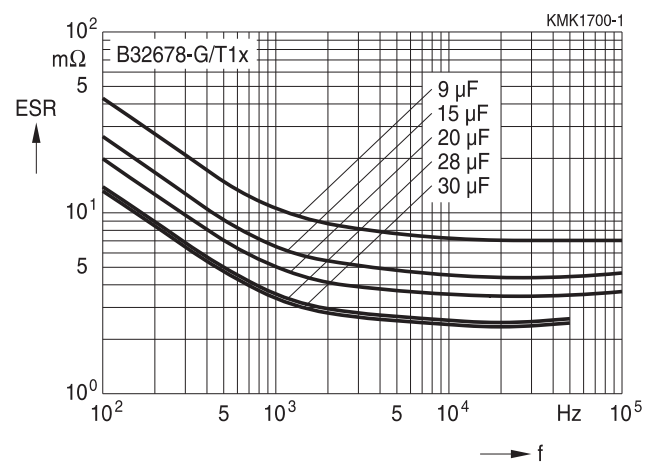

B32678

MKP DC link – high power series

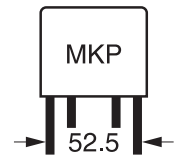

### Characteristics curves

Additional technical information can be found under "Design support" on [www.epcos.com](http://www.epcos.com).

#### Impedance Z versus frequency f (typical values)

Lead spacing 52.5 mm

875 V DC

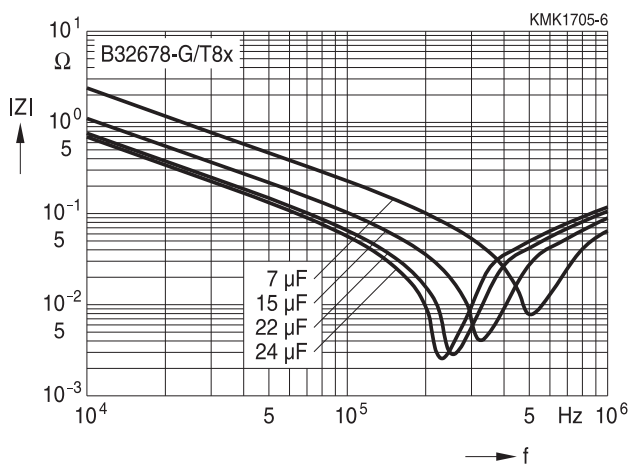

#### ESR versus frequency f (typical values)

Lead spacing 52.5 mm

875 V DC

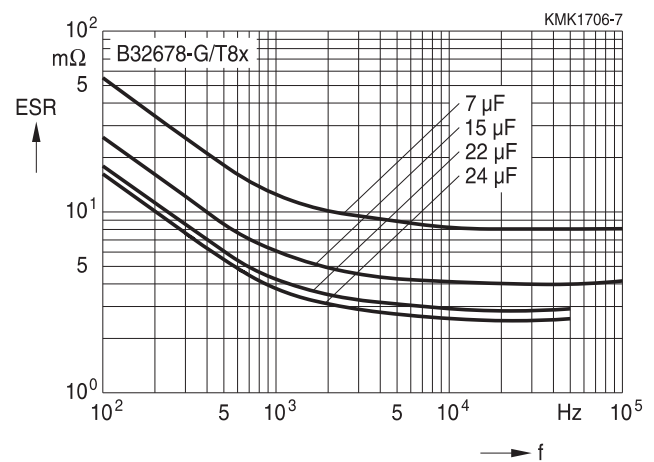

#### Impedance Z versus frequency f (typical values)

Lead spacing 52.5 mm (12 pins)

300 V DC, 450 V DC, 630 V DC,  
750 V DC, 875 V DC

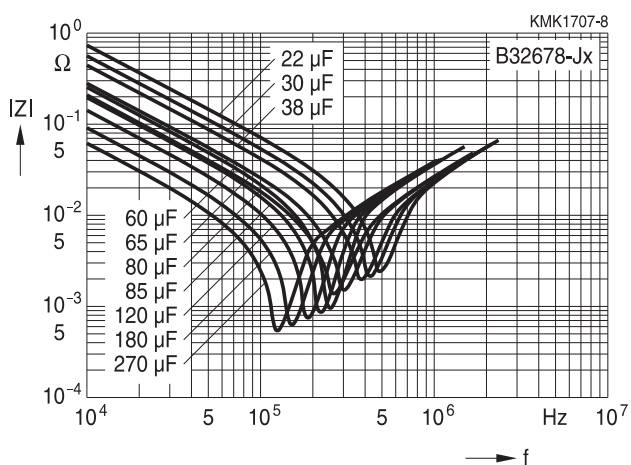

#### ESR versus frequency f (typical values)

Lead spacing 52.5 mm (12 pins)

300 V DC, 450 V DC, 630 V DC,  
750 V DC, 875 V DC

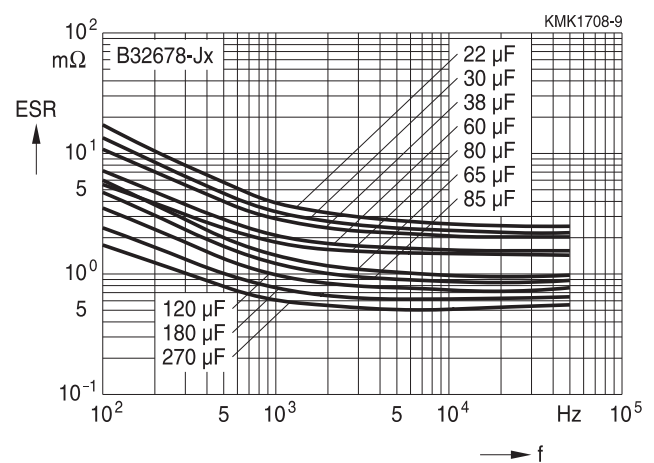



B32674

MKP DC link – high power series

**Characteristics curves**

**Permissible current  $I_{RMS}$  versus frequency  $f$  at 70 °C**

**Lead spacing 27.5 mm**

B32674D\*

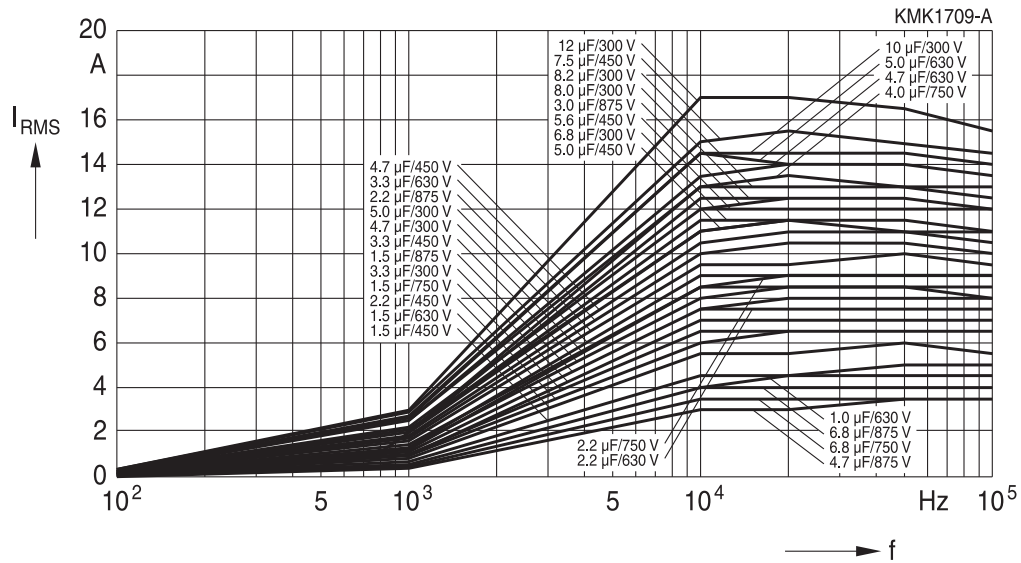



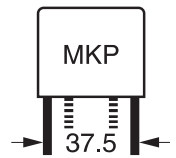

**Characteristics curves**

**Permissible current  $I_{RMS}$  versus frequency  $f$  at 70 °C**

**Lead spacing 37.5 mm**

**B32676G/T\***

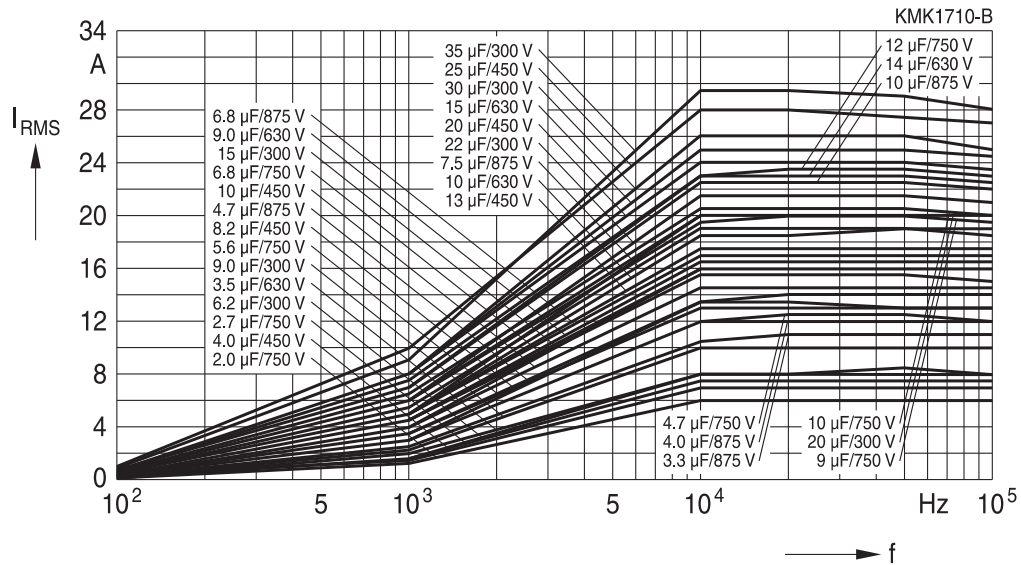

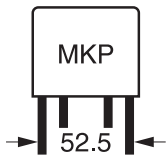

**B32678**  
**MKP DC link – high power series**

**Characteristics curves**

**Permissible current  $I_{RMS}$  versus frequency  $f$  at 70 °C**

**Lead spacing 52.5 mm**

**B32678G/T\***

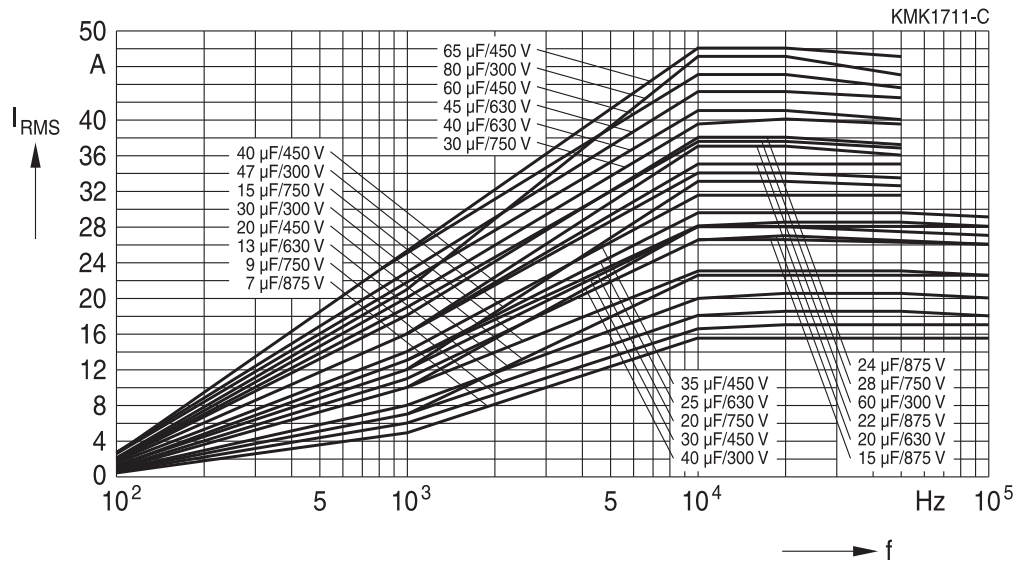

**B32678J\***

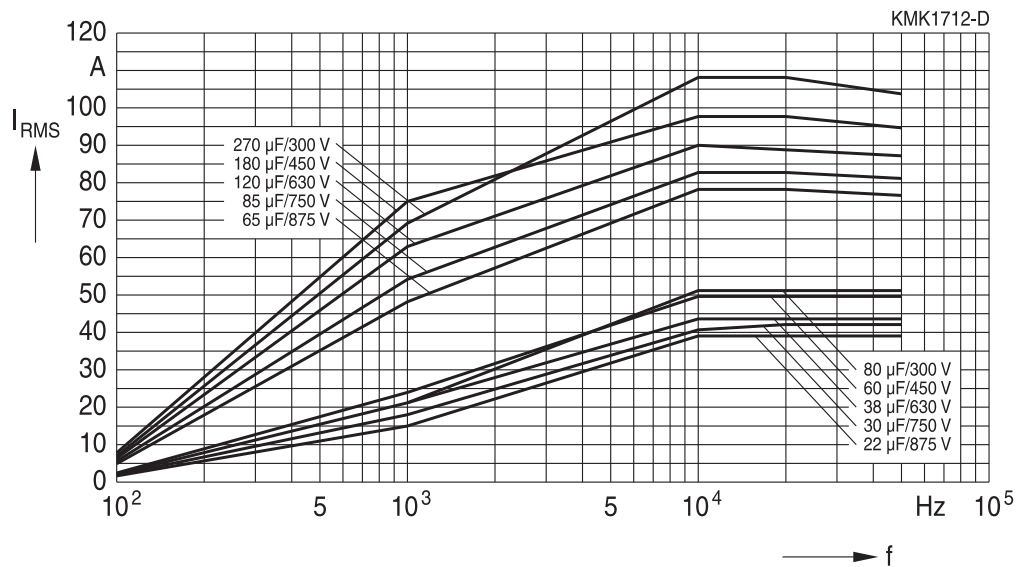

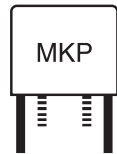

**Curves characteristics ( $I_{RMS}$  derating versus temperature)**

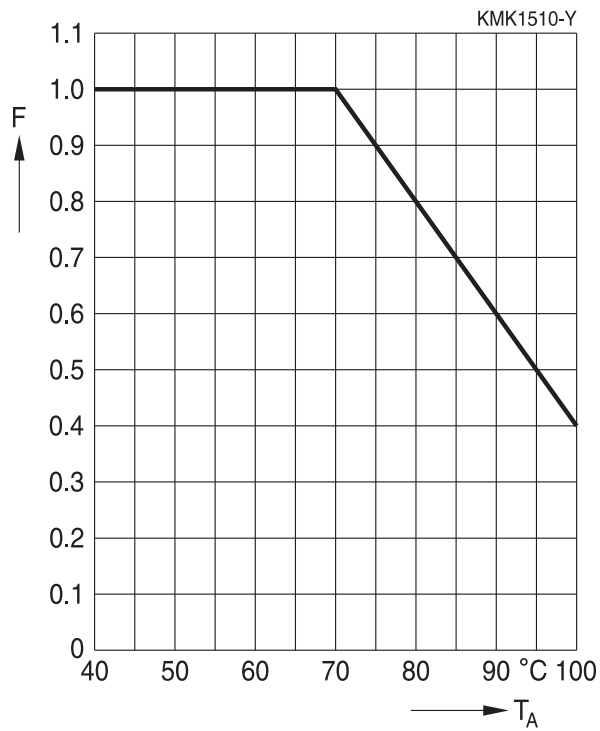

Maximum  $I_{RMS}$  current as function of the ambient temperature:  $I_{RMS}(T_A) = \text{Factor} \times I_{RMS}(70\text{ °C})$



B32674 ... B32678

MKP DC link – high power series

### Heat transference for self heating calculation

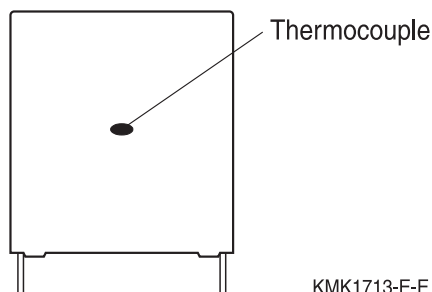

Figure 1 (2-pin, 4-pin)

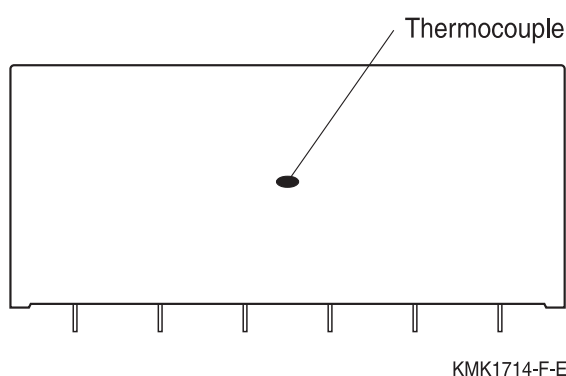
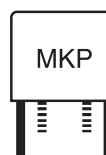

Figure 2 (12-pin)

Box dimensions			Equivalent heat coefficient G (mW/°C)
w (mm)	h (mm)	l (mm)	
11.0	19.0	31.5	25
11.0	21.0	31.5	28
12.5	21.5	31.5	30
13.5	23.0	31.5	32
14.0	24.5	31.5	35
15.0	24.5	31.5	36
16.0	32.0	31.5	45
18.0	27.5	31.5	44
18.0	33.0	31.5	48
19.0	30.0	31.5	48
20.0	11.0	31.5	65
21.0	31.0	31.5	51
22.0	36.5	31.5	58
12.0	22.0	41.5	70
14.0	25.0	41.5	43
16.0	28.5	41.5	50
18.0	32.5	41.5	59
20.0	39.5	42.0	72
24.0	19.0	41.5	50
24.0	15.0	41.5	44
28.0	37.0	42.0	83
28.0	42.5	42.0	90
30.0	45.0	42.0	100
33.0	48.0	42.0	110
43.0	22.0	41.5	80
30.0	45.0	57.5	125
35.0	50.0	57.5	145
43.0	24.0	57.5	103
45.0	57.0	57.5	185
60.0	45.0	57.5	192
130.0	24.0	57.5	200
130.0	58.0	57.5	300

The equivalent heat coefficient "G (mW/°C)" is given for measuring the temperature on the lateral surface of the plastic box as figure1 shows. By using a thermocouple and avoiding effect of radiation and convection the temperature measured during operation conditions should be a result of the dissipated power divided by the equivalent heat coefficient.



### Self Heating by power dissipation and equivalent heat coefficient

The  $I_{RMS}$  and consequently the power dissipation must be limited during operation in order to not exceed the maximum limit of  $\Delta T$  allowed for this series.  $\Delta T_{max}$  given for this series is equal or lower than 20 °C at rated temperature (70 °C), for higher ambient temperatures  $\Delta T_{max}(T)$  will have the same derating factor than  $I_{RMS}$  versus temperature and then an equivalent derating as per:

$$\Delta T_{max}(T) = (\text{Factor})^2 \times \Delta T(70\text{ °C}).$$

For any particular  $I_{RMS}$  the  $\Delta T$  may be calculated by:

$$\Delta T(\text{°C}) = P_{dis}(\text{mW}) / G(\text{mW/°C}).$$

Where  $\Delta T(\text{°C})$  is the difference between the temperature measured on the box (see figure 1) and the ambient temperature when capacitor is working during normal operation;

$$\Delta T(\text{°C}) = T_{op}(\text{°C}) - T_A(\text{°C}).$$

It represents the increasing of temperature provoked by the  $I_{RMS}$  during operation.

$G(\text{mW/°C})$  is the equivalent heat coefficient described above and  $P_{dis}(\text{mW})$  is the dissipated power defined by:

$$P_{dis}(\text{mW}) = ESR_{typ}(\text{m}\Omega) \times I_{RMS}^2(\text{A}_{RMS}).$$

### Example for thermal calculation:

We will take as reference B32678G8156K (15  $\mu\text{F}/875\text{ V}$ ) type for thermal calculation. Considering the following load and capacitor characteristics:

$I_{RMS}$ : 15  $A_{RMS}$  at 20 kHz

$T_A$ : 85 °C

35 × 50 × 57.5 box

$G(\text{mW/°C})$ : 145

Then we have to find the  $ESR_{typ}$  at 20 kHz what is approximately 4.0 m $\Omega$ .

So according to  $P_{dis}(\text{mW}) = ESR_{typ}(\text{m}\Omega) \times I_{RMS}^2(\text{A}_{RMS})$

we have the following:  $P_{dis}(\text{mW}) = 4.0\text{ m}\Omega \times 15\text{ A}_{RMS}^2 = 900\text{ mW}$ .

And as per  $\Delta T(\text{°C}) = P_{dis}(\text{mW}) / G(\text{mW/°C})$

we have the following:  $\Delta T(\text{°C}) = 900(\text{mW}) / 145(\text{mW/°C}) = 6.2\text{ °C}$ .

What is below of the  $\Delta T_{max}(85\text{ °C}) = (\text{Factor})^2 \times \Delta T(70\text{ °C}) = (0.7)^2 \times 20\text{ °C} = 9.8\text{ °C}$ .

On the other hand we may confirm that max  $I_{RMS}$  at 20 kHz at 70 °C = 26.5  $A_{RMS}$ .

And then max  $I_{RMS}$  for 85 °C of ambient temperature is defined as follows:

$$I_{RMS}(85\text{ °C}) = \text{Factor} \times I_{RMS}(70\text{ °C}) = 0.7 \times 26.5\text{ A}_{RMS} = 18.55\text{ A}_{RMS}.$$

What confirms once again that  $I_{RMS}$  (15  $A_{RMS}$  at 20 kHz at 85 °C) is below the max specified for such frequency and ambient temperature.

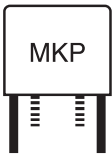

B32674 ... B32678

MKP DC link – high power series

**Life time expectancy - typical curve**

B3267\*3/4/6/1/8 (300 V DC / 450 V DC / 630 V DC / 750 V DC / 875 V DC)

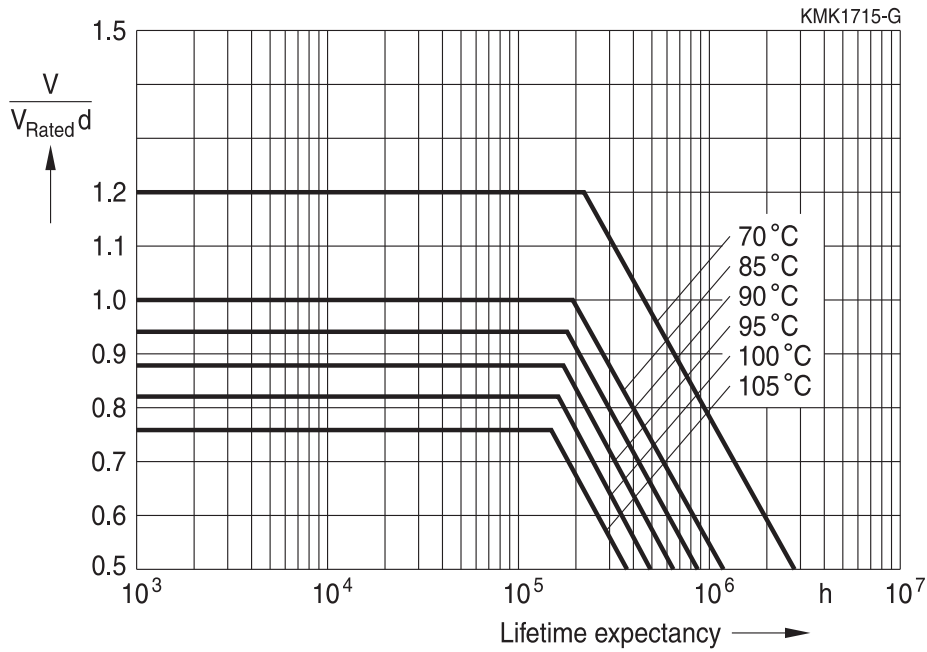

Note: Confidence level of 98%

**Testing and Standards**

Test	Reference	Conditions of test	Performance requirements
Electrical parameters (Routine test)	IEC61071:2007	Voltage between terminals, 1.5 V <sub>R</sub> , during 10 s Insulation resistance, R <sub>ins</sub> at V <sub>R</sub> if V <sub>R</sub> < 500 V or 500 V if V <sub>R</sub> ≥ 500 V Capacitance, C at 1 kHz (room temperature) Dissipation factor, tan δ at 1/10 kHz (room temperature)	Within specified limits
Robustness of terminations (Type test)	IEC 60068-2-21:2006	Tensile strength (test Ua1) Wire diameter   Tensile force 0.5 < d <sub>1</sub> ≤ 0.8 mm   10 N 0.8 < d <sub>1</sub> ≤ 1.25 mm   20 N	Capacitance and tan δ within specified limits
Resistance to soldering heat (Type test)	IEC 60068-2-20:2008, test Tb, method 1A	Solder bath temperature at 260 ± 5 °C, immersion for 10 seconds	ΔC/C <sub>0</sub>   ≤ 2%  Δ tan δ  ≤ 0.002
Rapid change of temperature (Type test)	IEC 60384-16:2005	T <sub>A</sub> = lower category temperature T <sub>B</sub> = upper category temperature Five cycles, duration t = 30 min.	ΔC/C <sub>0</sub>   ≤ 2%  Δ tan δ  ≤ 0.002 R <sub>ins</sub> ≥ 50% of initial limit
Vibration (Type test)	IEC 60384-16:2005	Test F <sub>C</sub> : vibration sinusoidal Displacement: 0.75 mm Acceleration: 98 m/s <sup>2</sup> Frequency: 10 Hz ... 500 Hz Test duration: 3 orthogonal axes, 2 hours each axe	No visible damage
Bump (Type test)	IEC 60384-16:2005	Test Eb: Total 4000 bumps with 390 m/s <sup>2</sup> mounted on PCB Duration: 6 ms	No visible damage  ΔC/C <sub>0</sub>   ≤ 2%  Δ tan δ  ≤ 0.002 R <sub>ins</sub> ≥ 50% of initial limit
Climatic sequence (Type test)	IEC 60384-16:2005	Dry heat Tb / 16 h Damp heat cyclic, 1 <sup>st</sup> cycle +55 °C / 24 h / 95% ... 100% RH Cold Ta / 2 h Damp heat cyclic, 5 cycles +55 °C / 24 h / 95% ... 100% RH	No visible damage  ΔC/C <sub>0</sub>   ≤ 3%  Δ tan δ  ≤ 0.001 R <sub>ins</sub> ≥ 50% of initial limit



B32674 ... B32678

MKP DC link – high power series

Test	Reference	Conditions of test	Performance requirements
Damp heat, steady state (Type test)	IEC 60384-16:2005	Test Ca 40 °C / 93% RH / 56 days	No visible damage $ \Delta C/C_0  \leq 5\%$ $ \Delta \tan \delta  \leq 0.005$ $R_{ins} \geq 50\%$ of initial limit
Endurance (Type test)	IEC61071:2007	70 °C / 1.4 $V_R$ / 250 hours or $T_{op}$ / 1.4 $V_{op}$ / 250 hours + 1000 discharges at 1.4 $I_R$ +70 °C / 1.4 $V_R$ / 250 hours or $T_{op}$ / 1.4 $V_{op}$ / 250 hours	No visible damage $ \Delta C/C_0  \leq 3\%$ at 1 kHz $ \Delta \tan \delta  \leq 0.015$ at 10 kHz
Endurance (Type test)	IEC 60384-16:2005	70 °C / 1.25 $V_R$ / 1000 hours or 85 °C / 1.25 $V_{op}$ / 1000 hours or 100 °C / 1.25 $V_{op}$ / 1000 hours	No visible damage $ \Delta C/C_0  \leq 5\%$ at 1 kHz $ \Delta \tan \delta  \leq 0.005$ $R_{ins} \geq 50\%$ of initial limit

## Mounting guidelines

### 1 Soldering

#### 1.1 Solderability of leads

The solderability of terminal leads is tested to IEC 60068-2-20, test Ta, method 1.

Before a solderability test is carried out, terminals are subjected to accelerated ageing (to IEC 60068-2-2, test Ba: 4 h exposure to dry heat at 155 °C). Since the ageing temperature is far higher than the upper category temperature of the capacitors, the terminal wires should be cut off from the capacitor before the ageing procedure to prevent the solderability being impaired by the products of any capacitor decomposition that might occur.

Solder bath temperature	235 ±5 °C
Soldering time	2.0 ±0.5 s
Immersion depth	2.0 +0/–0.5 mm from capacitor body or seating plane
Evaluation criteria:	
Visual inspection	Wetting of wire surface by new solder ≥90%, free-flowing solder



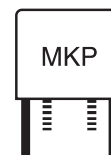

## 1.2 Resistance to soldering heat

Resistance to soldering heat is tested to IEC 60068-2-20, test Tb, method 1.

Conditions:

Series	Solder bath temperature	Soldering time
MKT boxed (except 2.5 × 6.5 × 7.2 mm) coated uncoated (lead spacing >10 mm)	260 ±5 °C	10 ±1 s
MFP		
MKP (lead spacing >7.5 mm)		
MKT boxed (case 2.5 × 6.5 × 7.2 mm)	260 ±5 °C	5 ±1 s
MKP (lead spacing ≤7.5 mm)		<4 s
MKT uncoated (lead spacing ≤10 mm)		recommended soldering profile for MKT uncoated (lead spacing ≤ 10 mm) and insulated (B32559)
MKT insulated (B32559)		

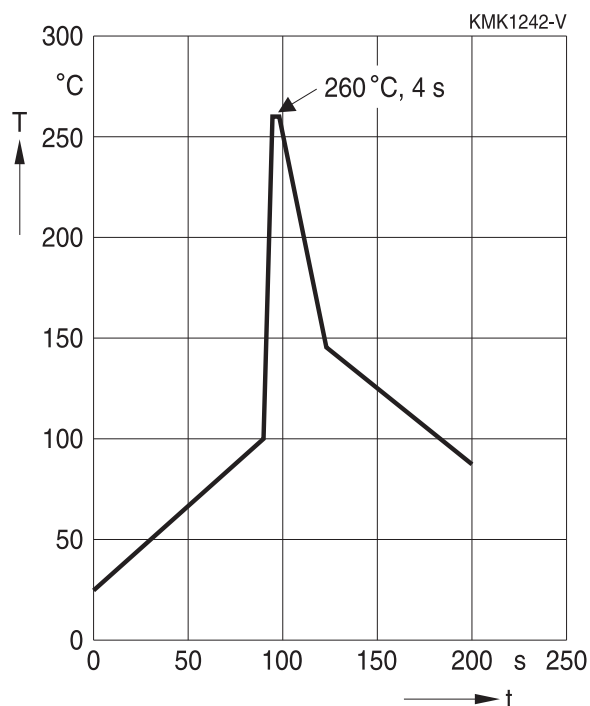

Immersion depth	2.0 +0/−0.5 mm from capacitor body or seating plane
Shield	Heat-absorbing board, (1.5 ±0.5) mm thick, between capacitor body and liquid solder
Evaluation criteria:	
Visual inspection	No visible damage
$\Delta C/C_0$	2% for MKT/MKP/MFP 5% for EMI suppression capacitors
$\tan \delta$	As specified in sectional specification

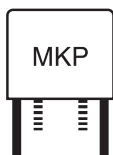

B32674 ... B32678

MKP DC link – high power series

### 1.3 General notes on soldering

Permissible heat exposure loads on film capacitors are primarily characterized by the upper category temperature  $T_{max}$ . Long exposure to temperatures above this type-related temperature limit can lead to changes in the plastic dielectric and thus change irreversibly a capacitor's electrical characteristics. For short exposures (as in practical soldering processes) the heat load (and thus the possible effects on a capacitor) will also depend on other factors like:

- Pre-heating temperature and time
- Forced cooling immediately after soldering
- Terminal characteristics:  
diameter, length, thermal resistance, special configurations (e.g. crimping)
- Height of capacitor above solder bath
- Shadowing by neighboring components
- Additional heating due to heat dissipation by neighboring components
- Use of solder-resist coatings

The overheating associated with some of these factors can usually be reduced by suitable countermeasures. For example, if a pre-heating step cannot be avoided, an additional or reinforced cooling process may possibly have to be included.

#### EPCOS recommendations

As a reference, the recommended wave soldering profile for our film capacitors is as follows:



$T_s$ : Capacitor body maximum temperature at wave soldering

$T_p$ : Capacitor body maximum temperature at pre-heating

KMK1745-A-E

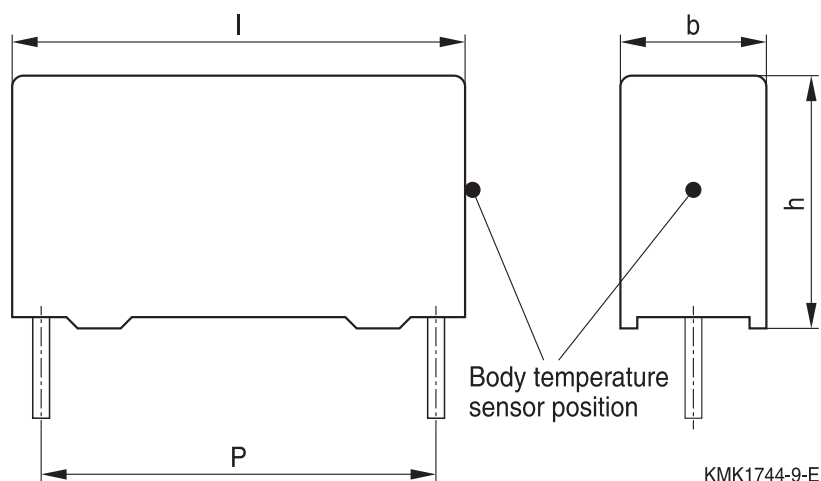

Body temperature should follow the description below:

- MKP capacitor
  - During pre-heating:  $T_p \leq 110 \text{ }^\circ\text{C}$
  - During soldering:  $T_s \leq 120 \text{ }^\circ\text{C}$ ,  $t_s \leq 45 \text{ s}$
- MKT capacitor
  - During pre-heating:  $T_p \leq 125 \text{ }^\circ\text{C}$
  - During soldering:  $T_s \leq 160 \text{ }^\circ\text{C}$ ,  $t_s \leq 45 \text{ s}$

When SMD components are used together with leaded ones, the film capacitors should not pass into the SMD adhesive curing oven. The leaded components should be assembled after the SMD curing step.

Leaded film capacitors are not suitable for reflow soldering.

In order to ensure proper conditions for manual or selective soldering, the body temperature of the capacitor ( $T_s$ ) must be  $\leq 120 \text{ }^\circ\text{C}$ .

One recommended condition for manual soldering is that the tip of the soldering iron should be  $< 360 \text{ }^\circ\text{C}$  and the soldering contact time should be no longer than 3 seconds.

For uncoated MKT capacitors with lead spacings  $\leq 10 \text{ mm}$  (B32560/B32561) the following measures are recommended:

- pre-heating to not more than  $110 \text{ }^\circ\text{C}$  in the preheater phase
- rapid cooling after soldering

Please refer to EPCOS Film Capacitor Data Book in case more details are needed.



B32674 ... B32678

MKP DC link – high power series

### Cautions and warnings

- Do not exceed the upper category temperature (UCT).
- Do not apply any mechanical stress to the capacitor terminals.
- Avoid any compressive, tensile or flexural stress.
- Do not move the capacitor after it has been soldered to the PC board.
- Do not pick up the PC board by the soldered capacitor.
- Do not place the capacitor on a PC board whose PTH hole spacing differs from the specified lead spacing.
- Do not exceed the specified time or temperature limits during soldering.
- Avoid external energy inputs, such as fire or electricity.
- Avoid overload of the capacitors.
- Consult us if application is with severe temperature and humidity condition.
- There are no serviceable or repairable parts inside the capacitor. Opening the capacitor or any attempts to open or repair the capacitor will void the warranty and liability of EPCOS.
- Please note that the standards referred to in this publication may have been revised in the meantime.

The table below summarizes the safety instructions that must always be observed. A detailed description can be found in the relevant sections of the chapters "General technical information" and "Mounting guidelines".

Topic	Safety information	Reference chapter "General technical information"
Storage conditions	Make sure that capacitors are stored within the specified range of time, temperature and humidity conditions.	4.5 "Storage conditions"
Flammability	Avoid external energy, such as fire or electricity (passive flammability), avoid overload of the capacitors (active flammability) and consider the flammability of materials.	5.3 "Flammability"
Resistance to vibration	Do not exceed the tested ability to withstand vibration. The capacitors are tested to IEC 60068-2-6:2007. EPCOS offers film capacitors specially designed for operation under more severe vibration regimes such as those found in automotive applications. Consult our catalog "Film Capacitors for Automotive Electronics".	5.2 "Resistance to vibration"

Topic	Safety information	Reference chapter "Mounting guidelines"
Soldering	Do not exceed the specified time or temperature limits during soldering.	1 "Soldering"
Cleaning	Use only suitable solvents for cleaning capacitors.	2 "Cleaning"

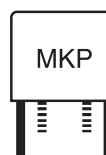

Topic	Safety information	Reference chapter "Mounting guidelines"
Embedding of capacitors in finished assemblies	When embedding finished circuit assemblies in plastic resins, chemical and thermal influences must be taken into account. Caution: Consult us first, if you also wish to embed other uncoated component types!	3 "Embedding of capacitors in finished assemblies"

### Display of ordering codes for EPCOS products

The ordering code for one and the same product can be represented differently in data sheets, data books, other publications and the website of EPCOS, or in order-related documents such as shipping notes, order confirmations and product labels. **The varying representations of the ordering codes are due to different processes employed and do not affect the specifications of the respective products.** Detailed information can be found on the Internet under [www.epcos.com/orderingcodes](http://www.epcos.com/orderingcodes).



B32674 ... B32678

MKP DC link – high power series

## Symbols and terms

Symbol	English	German
$\alpha$	Heat transfer coefficient	Wärmeübergangszahl
$\alpha_C$	Temperature coefficient of capacitance	Temperaturkoeffizient der Kapazität
A	Capacitor surface area	Kondensatoroberfläche
$\beta_C$	Humidity coefficient of capacitance	Feuchtekoeffizient der Kapazität
C	Capacitance	Kapazität
$C_R$	Rated capacitance	Nennkapazität
$\Delta C$	Absolute capacitance change	Absolute Kapazitätsänderung
$\Delta C/C$	Relative capacitance change (relative deviation of actual value)	Relative Kapazitätsänderung (relative Abweichung vom Ist-Wert)
$\Delta C/C_R$	Capacitance tolerance (relative deviation from rated capacitance)	Kapazitätstoleranz (relative Abweichung vom Nennwert)
dt	Time differential	Differentielle Zeit
$\Delta t$	Time interval	Zeitintervall
$\Delta T$	Absolute temperature change (self-heating)	Absolute Temperaturänderung (Selbsterwärmung)
$\Delta \tan \delta$	Absolute change of dissipation factor	Absolute Änderung des Verlustfaktors
$\Delta V$	Absolute voltage change	Absolute Spannungsänderung
dV/dt	Time differential of voltage function (rate of voltage rise)	Differentielle Spannungsänderung (Spannungsflankensteilheit)
$\Delta V/\Delta t$	Voltage change per time interval	Spannungsänderung pro Zeitintervall
E	Activation energy for diffusion	Aktivierungsenergie zur Diffusion
ESL	Self-inductance	Eigeninduktivität
ESR	Equivalent series resistance	Ersatz-Serienwiderstand
f	Frequency	Frequenz
$f_1$	Frequency limit for reducing permissible AC voltage due to thermal limits	Grenzfrequenz für thermisch bedingte Reduzierung der zulässigen Wechselspannung
$f_2$	Frequency limit for reducing permissible AC voltage due to current limit	Grenzfrequenz für strombedingte Reduzierung der zulässigen Wechselspannung
$f_r$	Resonant frequency	Resonanzfrequenz
$F_D$	Thermal acceleration factor for diffusion	Therm. Beschleunigungsfaktor zur Diffusion
$F_T$	Derating factor	Deratingfaktor
i	Current (peak)	Stromspitze
$I_C$	Category current (max. continuous current)	Kategoriestrom (max. Dauerstrom)

Symbol	English	German
$I_{RMS}$	(Sinusoidal) alternating current, root-mean-square value	(Sinusförmiger) Wechselstrom
$i_z$	Capacitance drift	Inkonstanz der Kapazität
$k_0$	Pulse characteristic	Impuls Kennwert
$L_S$	Series inductance	Serieninduktivität
$\lambda$	Failure rate	Ausfallrate
$\lambda_0$	Constant failure rate during useful service life	Konstante Ausfallrate in der Nutzungsphase
$\lambda_{test}$	Failure rate, determined by tests	Experimentell ermittelte Ausfallrate
$P_{diss}$	Dissipated power	Abgegebene Verlustleistung
$P_{gen}$	Generated power	Erzeugte Verlustleistung
$Q$	Heat energy	Wärmeenergie
$\rho$	Density of water vapor in air	Dichte von Wasserdampf in Luft
$R$	Universal molar constant for gases	Allg. Molarkonstante für Gas
$R$	Ohmic resistance of discharge circuit	Ohmscher Widerstand des Entladekreises
$R_i$	Internal resistance	Innenwiderstand
$R_{ins}$	Insulation resistance	Isolationswiderstand
$R_P$	Parallel resistance	Parallelwiderstand
$R_S$	Series resistance	Serienwiderstand
$S$	severity (humidity test)	Schärfegrad (Feuchtetest)
$t$	Time	Zeit
$T$	Temperature	Temperatur
$\tau$	Time constant	Zeitkonstante
$\tan \delta$	Dissipation factor	Verlustfaktor
$\tan \delta_D$	Dielectric component of dissipation factor	Dielektrischer Anteil des Verlustfaktors
$\tan \delta_P$	Parallel component of dissipation factor	Parallelanteil des Verlustfaktors
$\tan \delta_S$	Series component of dissipation factor	Serienanteil des Verlustfaktors
$T_A$	Temperature of the air surrounding the component	Temperatur der Luft, die das Bauteil umgibt
$T_{max}$	Upper category temperature	Obere Kategorietemperatur
$T_{min}$	Lower category temperature	Untere Kategorietemperatur
$t_{OL}$	Operating life at operating temperature and voltage	Betriebszeit bei Betriebstemperatur und -spannung
$T_{op}$	Operating temperature, $T_A + \Delta T$	Betriebstemperatur, $T_A + \Delta T$
$T_R$	Rated temperature	Nenntemperatur
$T_{ref}$	Reference temperature	Referenztemperatur
$t_{SL}$	Reference service life	Referenz-Lebensdauer



B32674 ... B32678

MKP DC link – high power series

Symbol	English	German
$V_{AC}$	AC voltage	Wechselspannung
$V_C$	Category voltage	Kategorie <span>spannung</span>
$V_{C,RMS}$	Category AC voltage	(Sinusförmige) Kategorie-Wechselspannung
$V_{CD}$	Corona-discharge onset voltage	Teilentlade-Einsatzspannung
$V_{ch}$	Charging voltage	Ladespannung
$V_{DC}$	DC voltage	Gleichspannung
$V_{FB}$	Fly-back capacitor voltage	Spannung (Flyback)
$V_i$	Input voltage	Eingangsspannung
$V_o$	Output voltage	Ausgangsspannung
$V_{op}$	Operating voltage	Betriebsspannung
$V_p$	Peak pulse voltage	Impuls-Spitzen <span>spannung</span>
$V_{pp}$	Peak-to-peak voltage Impedance	Spannungshub
$V_R$	Rated voltage	Nennspannung
$\hat{V}_R$	Amplitude of rated AC voltage	Amplitude der Nenn-Wechselspannung
$V_{RMS}$	(Sinusoidal) alternating voltage, root-mean-square value	(Sinusförmige) Wechselspannung
$V_{SC}$	S-correction voltage	Spannung bei Anwendung "S-correction"
$V_{sn}$	Snubber capacitor voltage	Spannung bei Anwendung "Beschaltung"
$Z$	Impedance	Scheinwiderstand
$e$	Lead spacing	Rastermaß



## Important notes

The following applies to all products named in this publication:

1. Some parts of this publication contain **statements about the suitability of our products for certain areas of application**. These statements are based on our knowledge of typical requirements that are often placed on our products in the areas of application concerned. We nevertheless expressly point out **that such statements cannot be regarded as binding statements about the suitability of our products for a particular customer application**. As a rule, EPCOS is either unfamiliar with individual customer applications or less familiar with them than the customers themselves. For these reasons, it is always ultimately incumbent on the customer to check and decide whether an EPCOS product with the properties described in the product specification is suitable for use in a particular customer application.
2. We also point out that **in individual cases, a malfunction of electronic components or failure before the end of their usual service life cannot be completely ruled out in the current state of the art, even if they are operated as specified**. In customer applications requiring a very high level of operational safety and especially in customer applications in which the malfunction or failure of an electronic component could endanger human life or health (e.g. in accident prevention or lifesaving systems), it must therefore be ensured by means of suitable design of the customer application or other action taken by the customer (e.g. installation of protective circuitry or redundancy) that no injury or damage is sustained by third parties in the event of malfunction or failure of an electronic component.
3. **The warnings, cautions and product-specific notes must be observed.**
4. In order to satisfy certain technical requirements, **some of the products described in this publication may contain substances subject to restrictions in certain jurisdictions (e.g. because they are classed as hazardous)**. Useful information on this will be found in our Material Data Sheets on the Internet ([www.epcos.com/material](http://www.epcos.com/material)). Should you have any more detailed questions, please contact our sales offices.
5. We constantly strive to improve our products. Consequently, **the products described in this publication may change from time to time**. The same is true of the corresponding product specifications. Please check therefore to what extent product descriptions and specifications contained in this publication are still applicable before or when you place an order. We also **reserve the right to discontinue production and delivery of products**. Consequently, we cannot guarantee that all products named in this publication will always be available. The aforementioned does not apply in the case of individual agreements deviating from the foregoing for customer-specific products.
6. Unless otherwise agreed in individual contracts, **all orders are subject to the current version of the "General Terms of Delivery for Products and Services in the Electrical Industry" published by the German Electrical and Electronics Industry Association (ZVEI)**.

## Important notes

7. **Our manufacturing sites serving the automotive business apply the IATF 16949 standard.** The IATF certifications confirm our compliance with requirements regarding the quality management system in the automotive industry. Referring to customer requirements and customer specific requirements (“CSR”) TDK always has and will continue to have the policy of respecting individual agreements. Even if IATF 16949 may appear to support the acceptance of unilateral requirements, we hereby like to emphasize that **only requirements mutually agreed upon can and will be implemented in our Quality Management System.** For clarification purposes we like to point out that obligations from IATF 16949 shall only become legally binding if individually agreed upon.
8. The trade names EPCOS, CeraCharge, CeraDiode, CeraLink, CeraPad, CeraPlas, CSMP, CTVS, DeltaCap, DigiSiMic, ExoCore, FilterCap, FormFit, LeaXield, MiniBlue, MiniCell, MKD, MKK, MotorCap, PCC, PhaseCap, PhaseCube, PhaseMod, PhiCap, PowerHap, PQSine, PQvar, SIFERRIT, SIFI, SIKOREL, SilverCap, SIMDAD, SiMic, SIMID, SineFormer, SIOV, ThermoFuse, WindCap are **trademarks registered or pending** in Europe and in other countries. Further information will be found on the Internet at [www.epcos.com/trademarks](http://www.epcos.com/trademarks).

Release 2018-06

# Mouser Electronics

Authorized Distributor

Click to View Pricing, Inventory, Delivery & Lifecycle Information:

## EPCOS / TDK:

[B32676G3306J000](#) [B32678G3406J000](#) [B32674D1105K](#) [B32674D1155K](#) [B32674D1225K](#) [B32674D1335K](#)  
[B32674D1405K](#) [B32674D1684K](#) [B32674D3106K](#) [B32674D3126K](#) [B32674D3225K](#) [B32674D3335K](#) [B32674D3475K](#)  
[B32674D3565K](#) [B32674D3685K](#) [B32674D3805K](#) [B32674D3825K](#) [B32674D4155K](#) [B32674D4225K](#)  
[B32674D4335K](#) [B32674D4475K](#) [B32674D4505K](#) [B32674D4565K](#) [B32674D4605K](#) [B32674D4685K](#) [B32674D4755K](#)  
[B32674D6105K](#) [B32674D6155K](#) [B32674D6225K](#) [B32674D6335K](#) [B32674D6475K](#) [B32674D6505K](#)  
[B32674D8105K](#) [B32674D8155K](#) [B32674D8225K](#) [B32674D8305K](#) [B32674D8474K](#) [B32674D8684K](#) [B32676E1106K](#)  
[B32676E1155K](#) [B32676E1205K](#) [B32676E1335K](#) [B32676E1475K](#) [B32676E1565K](#) [B32676E1685K](#) [B32676E1905K](#)  
[B32676E3106K](#) [B32676E3126K](#) [B32676E3156K](#) [B32676E3206K](#) [B32676E3226K](#) [B32676E3256K](#) [B32676E3306K](#)  
[B32676E3335K](#) [B32676E3475K](#) [B32676E3565K](#) [B32676E3655K](#) [B32676E3685K](#) [B32676E4106K](#) [B32676E4156K](#)  
[B32676E4206K](#) [B32676E4225K](#) [B32676E4305K](#) [B32676E4335K](#) [B32676E4405K](#) [B32676E4475K](#) [B32676E4565K](#)  
[B32676E4685K](#) [B32676E4825K](#) [B32676E6106K](#) [B32676E6126K](#) [B32676E6146K](#) [B32676E6205K](#) [B32676E6275K](#)  
[B32676E6335K](#) [B32676E6405K](#) [B32676E6475K](#) [B32676E6685K](#) [B32676E6755K](#) [B32676E6825K](#) [B32676E8105K](#)  
[B32676E8155K](#) [B32676E8225K](#) [B32676E8335K](#) [B32676E8405K](#) [B32676E8475K](#) [B32676E8685K](#) [B32676E8755K](#)  
[B32676G1106K](#) [B32676G1475K](#) [B32676G1565K](#) [B32676G1685K](#) [B32676G1905K](#) [B32676G3156K](#)  
[B32676G3206K](#) [B32676G3226K](#) [B32676G3256K](#) [B32676G3306K](#) [B32676G4106K](#) [B32676G4156K](#)

Компания «Океан Электроники» предлагает заключение долгосрочных отношений при поставках импортных электронных компонентов на взаимовыгодных условиях!

Наши преимущества:

- Поставка оригинальных импортных электронных компонентов напрямую с производств Америки, Европы и Азии, а так же с крупнейших складов мира;
- Широкая линейка поставок активных и пассивных импортных электронных компонентов (более 30 млн. наименований);
- Поставка сложных, дефицитных, либо снятых с производства позиций;
- Оперативные сроки поставки под заказ (от 5 рабочих дней);
- Экспресс доставка в любую точку России;
- Помощь Конструкторского Отдела и консультации квалифицированных инженеров;
- Техническая поддержка проекта, помощь в подборе аналогов, поставка прототипов;
- Поставка электронных компонентов под контролем ВП;
- Система менеджмента качества сертифицирована по Международному стандарту ISO 9001;
- При необходимости вся продукция военного и аэрокосмического назначения проходит испытания и сертификацию в лаборатории (по согласованию с заказчиком);
- Поставка специализированных компонентов военного и аэрокосмического уровня качества (Xilinx, Altera, Analog Devices, Intersil, Interpoint, Microsemi, Actel, Aeroflex, Peregrine, VPT, Syfer, Eurofarad, Texas Instruments, MS Kennedy, Miteq, Cobham, E2V, MA-COM, Hittite, Mini-Circuits, General Dynamics и др.);

Компания «Океан Электроники» является официальным дистрибьютором и эксклюзивным представителем в России одного из крупнейших производителей разъемов военного и аэрокосмического назначения «**JONHON**», а так же официальным дистрибьютором и эксклюзивным представителем в России производителя высокотехнологичных и надежных решений для передачи СВЧ сигналов «**FORSTAR**».



## JONHON

«**JONHON**» (основан в 1970 г.)

Разъемы специального, военного и аэрокосмического назначения:

(Применяются в военной, авиационной, аэрокосмической, морской, железнодорожной, горно- и нефтедобывающей отраслях промышленности)

«**FORSTAR**» (основан в 1998 г.)

ВЧ соединители, коаксиальные кабели,  
кабельные сборки и микроволновые компоненты:

(Применяются в телекоммуникациях гражданского и специального назначения, в средствах связи, РЛС, а так же военной, авиационной и аэрокосмической отраслях промышленности).



Телефон: 8 (812) 309-75-97 (многоканальный)

Факс: 8 (812) 320-03-32

Электронная почта: [ocean@oceanchips.ru](mailto:ocean@oceanchips.ru)

Web: <http://oceanchips.ru/>

Адрес: 198099, г. Санкт-Петербург, ул. Калинина, д. 2, корп. 4, лит. А