

Low-power, high-accuracy, general-purpose operational amplifier

Datasheet - production data



Related products

- See LMV82x series for higher gain bandwidth product (5.5 MHz)

Applications

- Battery-powered applications
- Portable devices
- Automotive signal conditioning
- Active filtering
- Medical instrumentation

Description

The TSV85x, TSV85xA series of single, dual, and quad operational amplifiers offer low voltage operation with a rail-to-rail output swing. The TSV85x, TSV85xA series outperforms the industry standard LMV321, proposing lower supply voltage capability, enhanced input offset voltage, and smaller packages.

The devices are offered with either industry standard pinouts or with a power-saving shutdown feature that reduces the supply current to a maximum of 50 nA at 25 °C.

The wide temperature range, high ESD tolerance, and automotive grade qualification ease the use in harsh automotive applications.

Features

- Low power consumption: 180 μ A max at 5 V
- Low power shutdown mode: 50 nA max
- Low offset voltage: 0.8 mV max at 25 °C
- Tiny packages
- Extended temperature range: -40 °C to 125 °C
- Low supply voltage: 2.3 V - 5.5 V
- Gain bandwidth product: 1.3 MHz
- Automotive qualification

Benefits

- Longer lifetime in battery-powered applications
- Higher accuracy without calibration
- Smaller form factor than equivalent competitor devices
- Application performances guaranteed over wide temperature ranges

Table 1. Device summary

	Without shutdown feature		With shutdown feature	
	Standard Vio	Enhanced Vio	Standard Vio	Enhanced Vio
Single	TSV851	TSV851A	TSV850	TSV850A
Dual	TSV852	TSV852A	TSV853	TSV853A
Quad	TSV854	TSV854A	TSV855	TSV855A

Contents

1	Package pin connections	3
2	Absolute maximum ratings and operating conditions	4
3	Electrical characteristics	6
4	Application information	14
	4.1 Operating voltages	14
	4.2 Input common-mode range	14
	4.3 Rail-to-rail output	14
	4.4 Input offset voltage drift over temperature	14
	4.5 PCB layouts	14
	4.6 Macromodel	14
	4.7 Shutdown function	15
5	Package information	16
	5.1 SC70-5 (or SOT323-5) package information	17
	5.2 SOT23-5 package information	18
	5.3 SOT23-6 package information	19
	5.4 DFN8 package information	20
	5.5 SO8 package information	21
	5.6 MiniSO8 package information	22
	5.7 MiniSO10 package information	23
	5.8 SO14 package information	24
	5.9 TSSOP14 package information	25
	5.10 TSSOP16 package information	26
	5.11 QFN16 3x3 package information	27
6	Ordering information	29
7	Revision history	30

1 Package pin connections

Figure 1. Pin connections for each package (top view)



1. The exposed pads of the DFN8 2x2 and QFN16 3x3 can be connected to VCC- or left floating.

2 Absolute maximum ratings and operating conditions

Table 2. Absolute maximum ratings (AMR)

Symbol	Parameter	Value	Unit
V_{CC}	Supply voltage ⁽¹⁾	6	V
V_{id}	Differential input voltage ⁽²⁾	$\pm V_{CC}$	
V_{in}	Input pins (IN+ and IN- pins) voltage ⁽³⁾	$V_{CC-} - 0.3$ to $V_{CC+} + 0.3$	
I_{in}	Input current ⁽⁴⁾	10	mA
\overline{SHDN}	Shutdown voltage ⁽⁵⁾	$V_{CC-} - 0.2$ to $V_{CC+} + 0.2$	V
T_{stg}	Storage temperature	-65 to +150	°C
R_{thja}	Thermal resistance junction to ambient ⁽⁶⁾⁽⁷⁾		°C/W
	SC70-5	205	
	SOT23-5	250	
	SOT23-6	240	
	DFN8 2x2	57	
	SO8	125	
	MiniSO8	190	
	MiniSO10	113	
	SO14	105	
	TSSOP14	100	
	TSSOP16	95	
QFN16 3x3	45		
T_j	Maximum junction temperature	150	°C
ESD	HBM: human body model (except shutdown pin) ⁽⁸⁾	4	kV
	HBM: human body model (shutdown pin) ⁽⁸⁾	3.5	kV
	MM: machine model ⁽⁹⁾	250	V
	CDM: charged device model ⁽¹⁰⁾	1.3	kV
	CDM: charged device model TSV855 ⁽¹⁰⁾	1	
	Latch-up immunity	200	mA

1. All voltage values, except differential voltage, are with respect to network ground terminal.
2. The differential voltage is the non-inverting input terminal with respect to the inverting input terminal.
3. $V_{CC-} - V_{in}$ must not exceed 6 V, V_{in} must not exceed 6 V.
4. Input current must be limited by a resistor in series with the inputs.
5. $V_{CC-} - V_{shdn}$ must not exceed 6 V, V_{in} must not exceed 6 V.
6. Short-circuits can cause excessive heating and destructive dissipation.
7. R_{th} are typical values.
8. Human body model: 100 pF discharged through a 1.5 kΩ resistor between two pins of the device, done for all couples of pin combinations with other pins floating.
9. Machine model: a 200 pF cap is charged to the specified voltage, then discharged directly between two pins of the device with no external series resistor (internal resistor < 5 Ω), done for all couples of pin combinations with other pins floating.
10. Charged device model: all pins plus package are charged together to the specified voltage and then discharged directly to the ground.

Table 3. Operating conditions

Symbol	Parameter	Value	Unit
V_{CC}	Supply voltage	2.3 to 5.5	V
V_{icm}	Common mode input voltage range	$V_{CC-} - 0.2$ to $V_{CC+} - 1$	
T_{oper}	Operating free air temperature range	-40 to +125	°C

3 Electrical characteristics

Table 4. Electrical characteristics at $V_{CC+} = 2.7\text{ V}$ with $V_{CC-} = 0\text{ V}$, $V_{icm} = V_{CC}/2$, $T_{amb} = 25\text{ }^{\circ}\text{C}$, and R_L connected to $V_{CC}/2$ (unless otherwise specified)

Symbol	Parameter	Conditions	Min.	Typ.	Max.	Unit
DC performance						
V_{io}	Input offset voltage	TSV85xA, $T = 25\text{ }^{\circ}\text{C}$			0.8	mV
		TSV85x, $T = 25\text{ }^{\circ}\text{C}$			4	
		TSV85xA, $-40\text{ }^{\circ}\text{C} < T < 125\text{ }^{\circ}\text{C}$			2	
		TSV85x, $-40\text{ }^{\circ}\text{C} < T < 125\text{ }^{\circ}\text{C}$			6	
$\Delta V_{io}/\Delta T$	Input offset voltage drift ⁽¹⁾	$-40\text{ }^{\circ}\text{C} < T < 125\text{ }^{\circ}\text{C}$		1		$\mu\text{V}/^{\circ}\text{C}$
I_{io}	Input offset current ($V_{out} = V_{CC}/2$)	$T = 25\text{ }^{\circ}\text{C}$		0.5	30	nA
		$-40\text{ }^{\circ}\text{C} < T < 125\text{ }^{\circ}\text{C}$		1	50	
I_{ib}	Input bias current ($V_{out} = V_{CC}/2$)	$T = 25\text{ }^{\circ}\text{C}$		27	60	nA
		$-40\text{ }^{\circ}\text{C} < T < 125\text{ }^{\circ}\text{C}$			110	
CMR	Common mode rejection ratio $20 \log (\Delta V_{icm}/\Delta V_{io})$ ($V_{ic} = 0\text{ V}$ to $V_{CC}-1\text{V}$, $V_{out} = V_{CC}/2$)	$T = 25\text{ }^{\circ}\text{C}$	70	75		dB
		$-40\text{ }^{\circ}\text{C} < T < 125\text{ }^{\circ}\text{C}$	68			
A_{vd}	Large signal voltage gain ($V_{out} = 0.5\text{V}$ to $(V_{CC}-0.5\text{V})$)	$R_L = 10\text{ k}\Omega$, $T = 25\text{ }^{\circ}\text{C}$	100	110		dB
		$R_L = 10\text{ k}\Omega$, $-40\text{ }^{\circ}\text{C} < T < 125\text{ }^{\circ}\text{C}$	90			
		$R_L = 2\text{ k}\Omega$, $T = 25\text{ }^{\circ}\text{C}$	90	100		
		$R_L = 2\text{ k}\Omega$, $-40\text{ }^{\circ}\text{C} < T < 125\text{ }^{\circ}\text{C}$	80			
$V_{CC}-V_{OH}$	High level output voltage	$R_L = 10\text{ k}\Omega$, $T = 25\text{ }^{\circ}\text{C}$		10	100	mV
		$R_L = 10\text{ k}\Omega$, $-40\text{ }^{\circ}\text{C} < T < 125\text{ }^{\circ}\text{C}$			200	
		$R_L = 2\text{ k}\Omega$, $T = 25\text{ }^{\circ}\text{C}$		40	300	
		$R_L = 2\text{ k}\Omega$, $-40\text{ }^{\circ}\text{C} < T < 125\text{ }^{\circ}\text{C}$			400	
V_{OL}	Low level output voltage	$R_L = 10\text{ k}\Omega$, $T = 25\text{ }^{\circ}\text{C}$		65	180	mV
		$R_L = 10\text{ k}\Omega$, $-40\text{ }^{\circ}\text{C} < T < 125\text{ }^{\circ}\text{C}$			280	
		$R_L = 2\text{ k}\Omega$, $T = 25\text{ }^{\circ}\text{C}$		120	300	
		$R_L = 2\text{ k}\Omega$, $-40\text{ }^{\circ}\text{C} < T < 125\text{ }^{\circ}\text{C}$			400	
I_{out}	I_{sink} ($V_{out} = V_{CC}$) $V_{id} = -1\text{ V}$	$T = 25\text{ }^{\circ}\text{C}$	15	26		mA
		$-40\text{ }^{\circ}\text{C} < T < 125\text{ }^{\circ}\text{C}$	15			
	I_{source} ($V_{out} = 0\text{ V}$) $V_{id} = 1\text{ V}$	$T = 25\text{ }^{\circ}\text{C}$	15	21		
		$-40\text{ }^{\circ}\text{C} < T < 125\text{ }^{\circ}\text{C}$	12			
I_{CC}	Supply current (per channel) No load, $V_{out} = V_{CC}/2$	$T = 25\text{ }^{\circ}\text{C}$		120	180	μA
		$-40\text{ }^{\circ}\text{C} < T < 125\text{ }^{\circ}\text{C}$			180	

Table 4. Electrical characteristics at $V_{CC+} = 2.7\text{ V}$ with $V_{CC-} = 0\text{ V}$, $V_{icm} = V_{CC}/2$, $T_{amb} = 25\text{ °C}$, and R_L connected to $V_{CC}/2$ (unless otherwise specified) (continued)

Symbol	Parameter	Conditions	Min.	Typ.	Max.	Unit
AC performance						
GBP	Gain bandwidth product	$R_L > 1\text{ M}\Omega$, $C_L = 200\text{ pF}$		1.3		MHz
F_u	Unity gain frequency			1		
Φ_m	Phase margin			60		degrees
G_m	Gain margin			10		dB
SR	Slew rate	$R_L > 1\text{ M}\Omega$, $C_L = 200\text{ pF}$ $V_{out} = 0.5\text{ V to } V_{CC} - 0.5\text{ V}$		0.6		V/ μ s
e_n	Equivalent input noise voltage	$f = 1\text{ kHz}$ $f = 10\text{ kHz}$		31 20		$\frac{nV}{\sqrt{Hz}}$
i_n	Equivalent input noise current	$f = 1\text{ kHz}$		0.30		$\frac{pA}{\sqrt{Hz}}$
THD+N	Total harmonic distortion + noise	$f_{in} = 1\text{ kHz}$, $A_{CL} = 1$, $R_L = 10\text{ k}\Omega$, $V_{icm} = V_{CC}/2$, $BW = 22\text{ kHz}$, $V_{out} = 1\text{ V}_{pp}$		0.002		%

1. See [Section 4.4: Input offset voltage drift over temperature](#).

Table 5. Shutdown characteristics $V_{CC} = 2.7\text{ V}$

Symbol	Parameter	Conditions	Min.	Typ.	Max.	Unit
DC performance						
I_{CC}	Supply current in shutdown mode (all operators)	$\overline{\text{SHDN}} = V_{CC-}$		2.5	50	nA
		$-40\text{ °C} < T < 85\text{ °C}$			200	
		$-40\text{ °C} < T < 125\text{ °C}$				1.5
t_{on}	Amplifier turn-on time ⁽¹⁾	$R_L = 2\text{ k}\Omega$, $V_{out} = V_{CC-}$ to $V_{CC} - 0.2\text{ V}$		300		ns
t_{off}	Amplifier turn-off time ⁽¹⁾	$R_L = 2\text{ k}\Omega$, $V_{out} = V_{CC+} - 1\text{ V}$ to $V_{CC+} - 1.2\text{ V}$		20		
V_{IH}	$\overline{\text{SHDN}}$ logic high		V_{CC-} 0.5			V
V_{IL}	$\overline{\text{SHDN}}$ logic low				0.5	
I_{IH}	$\overline{\text{SHDN}}$ current high	$\overline{\text{SHDN}} = V_{CC+}$		10		pA
I_{IL}	$\overline{\text{SHDN}}$ current low	$\overline{\text{SHDN}} = V_{CC-}$		10		
I_{OLeak}	Output leakage in shutdown mode	$\overline{\text{SHDN}} = V_{CC-}$		50		
		$-40\text{ °C} < T < 125\text{ °C}$		1		nA

1. See [Section 4.7: Shutdown function](#).

Table 6. Electrical characteristics at $V_{CC+} = 5\text{ V}$ with $V_{CC-} = 0\text{ V}$, $V_{icm} = V_{CC}/2$, $T_{amb} = 25\text{ °C}$, and R_L connected to $V_{CC}/2$ (unless otherwise specified)

Symbol	Parameter	Conditions	Min.	Typ.	Max.	Unit
DC performance						
V_{io}	Input offset voltage	TSV85xA, $T = 25\text{ °C}$			0.8	mV
		TSV85x, $T = 25\text{ °C}$			4	
		TSV85xA, $-40\text{ °C} < T < 125\text{ °C}$			2	
		TSV85x, $-40\text{ °C} < T < 125\text{ °C}$			6	
$\Delta V_{io}/\Delta T$	Input offset voltage drift ⁽¹⁾	$-40\text{ °C} < T < 125\text{ °C}$		1		$\mu\text{V}/\text{°C}$
I_{io}	Input offset current ($V_{out} = V_{CC}/2$)	$T = 25\text{ °C}$		0.5	30	nA
		$-40\text{ °C} < T < 125\text{ °C}$		1	50	
I_{ib}	Input bias current ($V_{out} = V_{CC}/2$)	$T = 25\text{ °C}$		27	60	nA
		$-40\text{ °C} < T < 125\text{ °C}$			110	
CMR	Common mode rejection ratio $20 \log (\Delta V_{icm}/\Delta V_{io})$ ($V_{ic} = 0\text{ V}$ to $V_{CC}-1\text{ V}$, $V_{out} = V_{CC}/2$)	$T = 25\text{ °C}$	72	75		dB
		$-40\text{ °C} < T < 125\text{ °C}$	70			
SVR	Supply voltage rejection ratio: $20 \log (\Delta V_{CC}/\Delta V_{io})$ $V_{CC} = 2.5$ to 5 V	$T = 25\text{ °C}$	72	79		dB
		$-40\text{ °C} < T < 125\text{ °C}$	70			
A_{vd}	Large signal voltage gain ($V_{out} = 0.5\text{ V}$ to $(V_{CC}-0.5\text{ V})$)	$R_L = 10\text{ k}\Omega$, $T = 25\text{ °C}$	100	110		dB
		$R_L = 10\text{ k}\Omega$, $-40\text{ °C} < T < 125\text{ °C}$	90			
		$R_L = 2\text{ k}\Omega$, $T = 25\text{ °C}$	90	100		
		$R_L = 2\text{ k}\Omega$, $-40\text{ °C} < T < 125\text{ °C}$	80			
$V_{CC}-V_{OH}$	High level output voltage	$R_L = 10\text{ k}\Omega$, $T=25\text{ °C}$		10	100	mV
		$R_L = 10\text{ k}\Omega$, $-40\text{ °C} < T < 125\text{ °C}$			200	
		$R_L = 2\text{ k}\Omega$, $T = 25\text{ °C}$		40	300	
		$R_L = 2\text{ k}\Omega$, $-40\text{ °C} < T < 125\text{ °C}$			400	
V_{OL}	Low level output voltage	$R_L = 10\text{ k}\Omega$, $T = 25\text{ °C}$		65	180	mV
		$R_L = 10\text{ k}\Omega$, $-40\text{ °C} < T < 125\text{ °C}$			280	
		$R_L = 2\text{ k}\Omega$, $T = 25\text{ °C}$		120	300	
		$R_L = 2\text{ k}\Omega$, $-40\text{ °C} < T < 125\text{ °C}$			400	
I_{out}	I_{sink} ($V_{out} = V_{CC}$) $V_{id} = -1\text{ V}$	$T = 25\text{ °C}$	35	43		mA
		$-40\text{ °C} < T < 125\text{ °C}$	25			
	I_{source} ($V_{out} = 0\text{ V}$) $V_{id} = 1\text{ V}$	$T = 25\text{ °C}$	60	70		
		$-40\text{ °C} < T < 125\text{ °C}$	50			
I_{CC}	Supply current (per channel) No load, $V_{out} = V_{CC}/2$	$T = 25\text{ °C}$		130	180	μA
		$-40\text{ °C} < T < 125\text{ °C}$			180	

Table 6. Electrical characteristics at $V_{CC+} = 5\text{ V}$ with $V_{CC-} = 0\text{ V}$, $V_{icm} = V_{CC}/2$, $T_{amb} = 25\text{ }^\circ\text{C}$, and R_L connected to $V_{CC}/2$ (unless otherwise specified) (continued)

Symbol	Parameter	Conditions	Min.	Typ.	Max.	Unit
AC performance						
GBP	Gain bandwidth product	$R_L > 1\text{ M}\Omega$, $C_L = 200\text{ pF}$		1.3		MHz
F_u	Unity gain frequency			1		
Φ_m	Phase margin			60		degrees
G_m	Gain margin			10		dB
SR	Slew rate	$R_L > 1\text{ M}\Omega$, $C_L = 200\text{ pF}$ $V_{out} = 0.5\text{ V}$ to $V_{CC} - 0.5\text{ V}$		0.7		V/ μs
e_n	Equivalent input noise voltage	$f = 1\text{ kHz}$ $f = 10\text{ kHz}$		30 20		$\frac{\text{nV}}{\sqrt{\text{Hz}}}$
i_n	Equivalent input noise current	$f = 1\text{ kHz}$		0.30		$\frac{\text{pA}}{\sqrt{\text{Hz}}}$
THD+N	Total harmonic distortion + noise	$f_{in} = 1\text{ kHz}$, $A_{CL} = 1$, $R_L = 10\text{ k}\Omega$, $V_{icm} = V_{CC}/2$, $BW = 22\text{ kHz}$, $V_{out} = 1\text{ V}_{pp}$		0.002		%

1. See [Section 4.4: Input offset voltage drift over temperature](#).

Table 7. Shutdown characteristics $V_{CC} = 5\text{ V}$

Symbol	Parameter	Conditions	Min.	Typ.	Max.	Unit
DC performance						
I_{CC}	Supply current in shutdown mode (per channel)	$\overline{\text{SHDN}} = V_{CC-}$		2.5	50	nA
		$-40\text{ }^\circ\text{C} < T < 85\text{ }^\circ\text{C}$			200	
		$-40\text{ }^\circ\text{C} < T < 125\text{ }^\circ\text{C}$				1.5
t_{on}	Amplifier turn-on time ⁽¹⁾	$R_L = 2\text{ k}\Omega$, $V_{out} = V_{CC-}$ to $V_{CC+} + 0.2\text{ V}$		300		ns
t_{off}	Amplifier turn-off time ⁽¹⁾	$R_L = 2\text{ k}\Omega$, $V_{out} = V_{CC+} - 1\text{ V}$ to $V_{CC+} - 1.2\text{ V}$		20		
V_{IH}	$\overline{\text{SHDN}}$ logic high		$V_{CC-} - 0.5$			V
V_{IL}	$\overline{\text{SHDN}}$ logic low				0.5	
I_{IH}	$\overline{\text{SHDN}}$ current high	$\overline{\text{SHDN}} = V_{CC+}$		10		pA
I_{IL}	$\overline{\text{SHDN}}$ current low	$\overline{\text{SHDN}} = V_{CC-}$		10		
I_{OLeak}	Output leakage in shutdown mode	$\overline{\text{SHDN}} = V_{CC-}$		50		
		$-40\text{ }^\circ\text{C} < T < 125\text{ }^\circ\text{C}$		1		nA

1. See [Section 4.7: Shutdown function](#).

Figure 2. Supply current vs. supply voltage at $V_{icm} = V_{CC}/2$

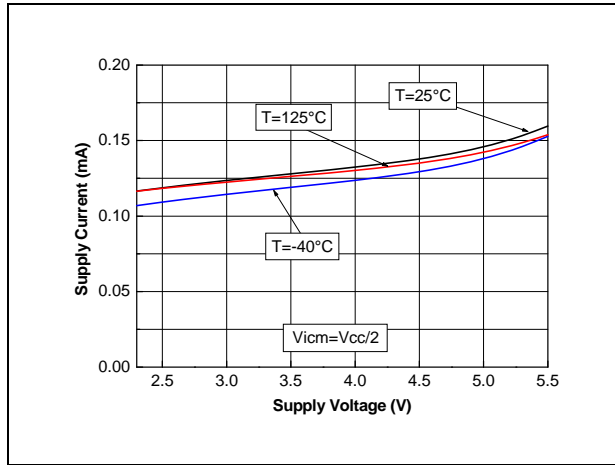

Figure 3. Vio distribution at $V_{CC} = 5\text{ V}$

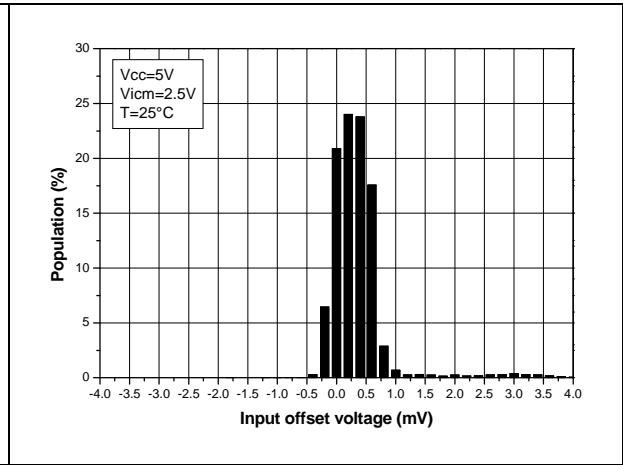

Figure 4. Input offset voltage vs. input common mode voltage at $V_{CC} = 5\text{ V}$

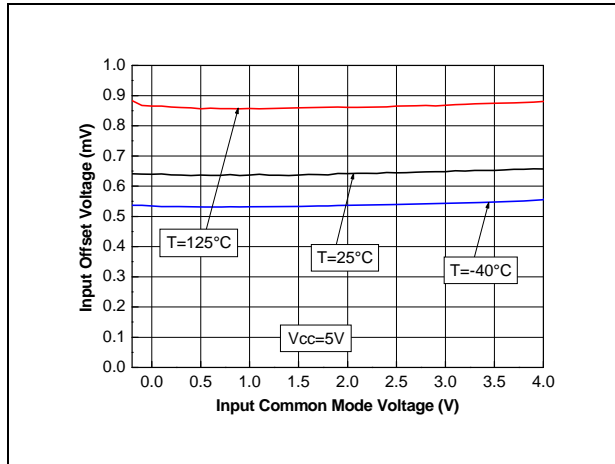

Figure 5. Output current vs. output voltage at $V_{CC} = 2.7\text{ V}$

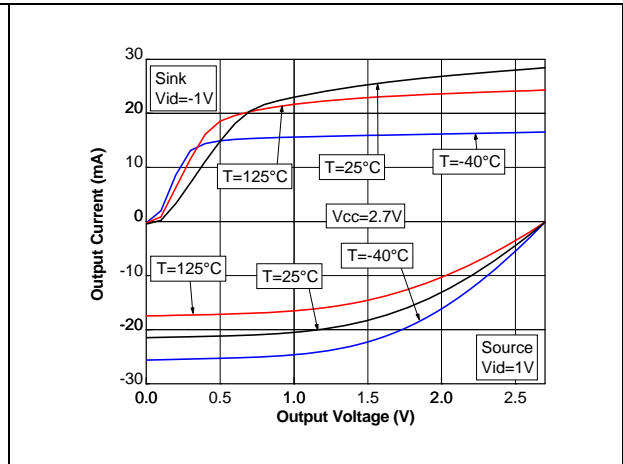

Figure 6. Output current vs. output voltage at $V_{CC} = 5\text{ V}$

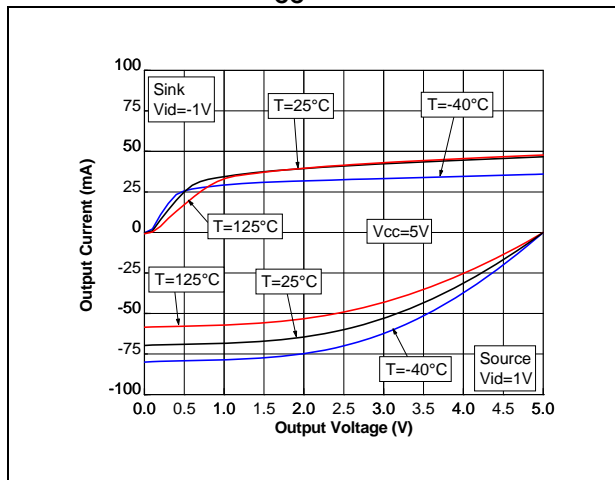

Figure 7. Output current vs. supply voltage at $V_{icm} = V_{CC}/2$

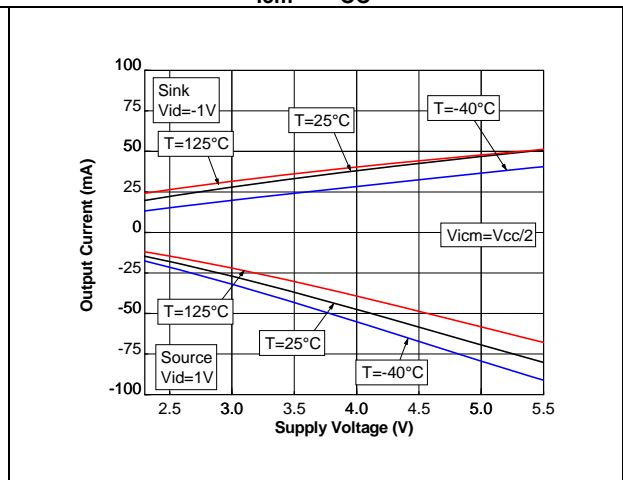

Figure 8. Voltage gain and phase with $C_l = 100\text{ pF}$



Figure 9. Voltage gain and phase with $C_l = 200\text{ pF}$



Figure 10. Gain margin vs. load capacitor at $V_{CC} = 5\text{ V}$



Figure 11. Phase margin vs. load capacitor at $V_{CC} = 5\text{ V}$



Figure 12. Closed-loop gain in voltage follower configuration for different capacitive loads

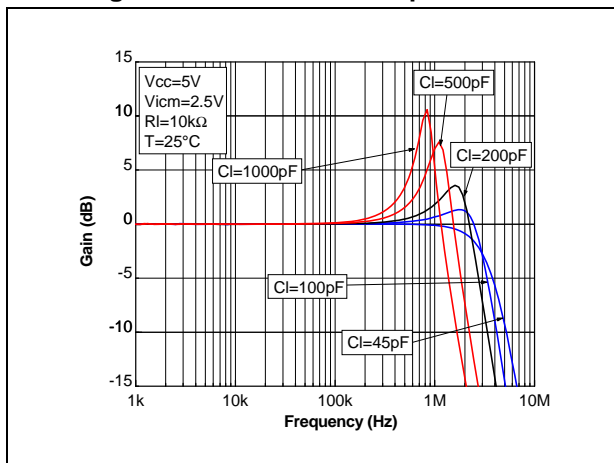

Figure 13. Phase margin vs. output current at $V_{CC} = 5\text{ V}$

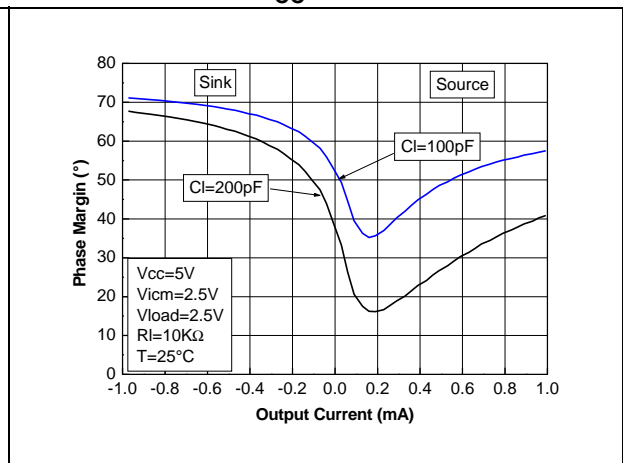

Figure 14. Positive and negative slew rate vs. supply voltage

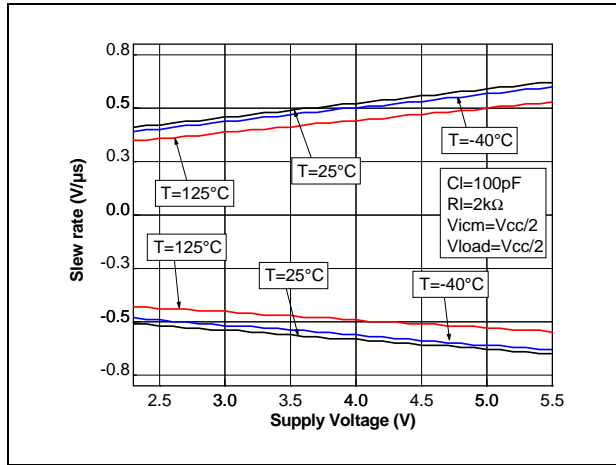

Figure 15. Positive slew rate at V_{CC} = 5 V with CI = 100 pF



Figure 16. Negative slew rate at V_{CC} = 5 V with CI = 100 pF

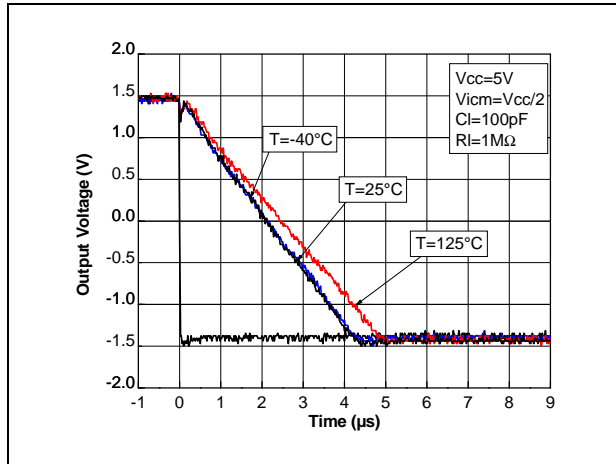

Figure 17. Noise vs. frequency



Figure 18. 0.1 Hz to 10 Hz noise at V_{CC} = 5 V

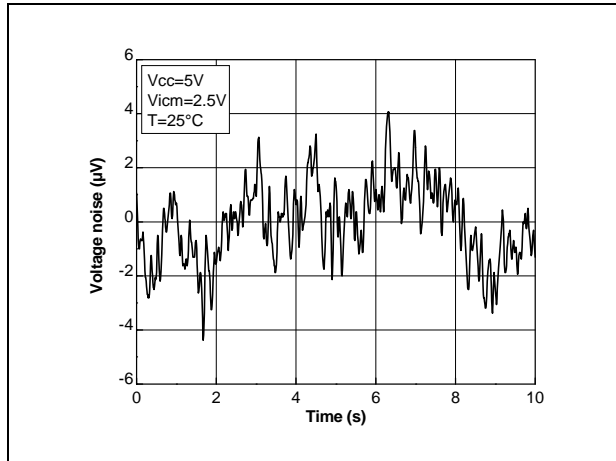

Figure 19. Distortion + noise vs. frequency



Figure 20. Distortion + noise vs. output voltage



4 Application information

4.1 Operating voltages

The TSV85x, TSV85xA can operate from 2.3 to 5.5 V. The devices' parameters are fully specified for 2.7 V and 5 V power supplies. Additionally, the main specifications are guaranteed in extended temperature ranges from -40 °C to +125 °C.

4.2 Input common-mode range

The TSV85x, TSV85xA has an input common-mode range that includes ground. The input common-mode range is extended from $V_{CC-} - 0.2$ V to $V_{CC+} - 1$ V, with no output phase reversal.

4.3 Rail-to-rail output

The operational amplifiers' output levels can go close to the rails: 180 mV maximum above and below the rail when connected to a 10 kΩ resistive load to $V_{CC}/2$.

4.4 Input offset voltage drift over temperature

The maximum input voltage drift over the temperature variation is defined as follows.

$$\frac{\Delta V_{io}}{\Delta T} = \max \left| \frac{V_{io}(T) - V_{io}(25^{\circ}\text{C})}{T - 25^{\circ}\text{C}} \right|$$

for $T_{\min} < T < T_{\max}$.

4.5 PCB layouts

For correct operation, it is advised to add 10 nF decoupling capacitors as close as possible to the power supply pins.

4.6 Macromodel

Accurate macromodels of the TSV85x, TSV85xA are available on STMicroelectronics' web site at www.st.com. These models are a trade-off between accuracy and complexity (that is, time simulation) of the TSV85x, TSV85xA operational amplifiers. They emulate the nominal performances of a typical device within the specified operating conditions mentioned in the datasheet. They also help to validate a design approach and to select the right operational amplifier, *but they do not replace on-board measurements*.

4.7 Shutdown function

The operational amplifier is enabled when the $\overline{\text{SHDN}}$ pin is pulled high. To disable the amplifier, the SHDN pin must be pulled down to V_{CC-} . When in shutdown mode, the amplifier output is in a high impedance state. The SHDN pin must never be left floating but tied to V_{CC+} or V_{CC-} .

The turn-on and turn-off times are calculated for an output variation of ± 200 mV (Figure 21 and Figure 22 show the test configurations). Figure 23 and Figure 24 show the respective results with these test configurations.

Figure 21. Test configuration for turn-on time (Vout pulled down)



Figure 22. Test configuration for turn-off time (Vout pulled down)



Figure 23. Turn-on time, $V_{CC} = 5$ V, Vout pulled down, $T = 25$ °C



Figure 24. Turn-off time, $V_{CC} = 5$ V, Vout pulled down, $T = 25$ °C



5 Package information

In order to meet environmental requirements, ST offers these devices in different grades of ECOPACK[®] packages, depending on their level of environmental compliance. ECOPACK[®] specifications, grade definitions and product status are available at: www.st.com. ECOPACK[®] is an ST trademark.

5.1 SC70-5 (or SOT323-5) package information

Figure 25. SC70-5 (or SOT323-5) package mechanical drawing



Table 8. SC70-5 (or SOT323-5) package mechanical data

Ref	Dimensions					
	Millimeters			Inches		
	Min	Typ	Max	Min	Typ	Max
A	0.80		1.10	0.032		0.043
A1			0.10			0.004
A2	0.80	0.90	1.00	0.032	0.035	0.039
b	0.15		0.30	0.006		0.012
c	0.10		0.22	0.004		0.009
D	1.80	2.00	2.20	0.071	0.079	0.087
E	1.80	2.10	2.40	0.071	0.083	0.094
E1	1.15	1.25	1.35	0.045	0.049	0.053
e		0.65			0.025	
e1		1.30			0.051	
L	0.26	0.36	0.46	0.010	0.014	0.018
<	0°		8°			

5.2 SOT23-5 package information

Figure 26. SOT23-5 package mechanical drawing



Table 9. SOT23-5 package mechanical data

Ref.	Dimensions					
	Millimeters			Inches		
	Min.	Typ.	Max.	Min.	Typ.	Max.
A	0.90	1.20	1.45	0.035	0.047	0.057
A1			0.15			0.006
A2	0.90	1.05	1.30	0.035	0.041	0.051
B	0.35	0.40	0.50	0.013	0.015	0.019
C	0.09	0.15	0.20	0.003	0.006	0.008
D	2.80	2.90	3.00	0.110	0.114	0.118
D1		1.90			0.075	
e		0.95			0.037	
E	2.60	2.80	3.00	0.102	0.110	0.118
F	1.50	1.60	1.75	0.059	0.063	0.069
L	0.10	0.35	0.60	0.004	0.013	0.023
K	0 degrees		10 degrees			

5.3 SOT23-6 package information

Figure 27. SOT23-6 package mechanical drawing



Table 10. SOT23-6 package mechanical data

Ref.	Dimensions					
	Millimeters			Inches		
	Min.	Typ.	Max.	Min.	Typ.	Max.
A	0.90		1.45	0.035		0.057
A1			0.10			0.004
A2	0.90		1.30	0.035		0.051
b	0.35		0.50	0.013		0.019
c	0.09		0.20	0.003		0.008
D	2.80		3.05	0.110		0.120
E	1.50		1.75	0.060		0.069
e		0.95			0.037	
H	2.60		3.00	0.102		0.118
L	0.10		0.60	0.004		0.024
°	0 °		10 °	0 °		10 °

5.4 DFN8 package information

Figure 28. DFN8 2x2 mm package mechanical drawing (pitch 0.5 mm)



Table 11. DFN8 2x2 mm package mechanical data (pitch 0.5 mm)

Ref.	Dimensions					
	Millimeters			Inches		
	Min.	Typ.	Max.	Min.	Typ.	Max.
A	0.51	0.55	0.60	0.020	0.022	0.024
A1			0.05			0.002
A3		0.15			0.006	
b	0.18	0.25	0.30	0.007	0.010	0.012
D	1.85	2.00	2.15	0.073	0.079	0.085
D2	1.45	1.60	1.70	0.057	0.063	0.067
E	1.85	2.00	2.15	0.073	0.079	0.085
E2	0.75	0.90	1.00	0.030	0.035	0.040
e		0.50			0.020	
L			0.425			0.017
ddd			0.08			0.003

5.5 SO8 package information

Figure 29. SO8 package mechanical drawing



Table 12. SO8 package mechanical data

Ref.	Dimensions					
	Millimeters			Inches		
	Min.	Typ.	Max.	Min.	Typ.	Max.
A			1.75			0.069
A1	0.10		0.25	0.004		0.010
A2	1.25			0.049		
b	0.28		0.48	0.011		0.019
c	0.17		0.23	0.007		0.010
D	4.80	4.90	5.00	0.189	0.193	0.197
E	5.80	6.00	6.20	0.228	0.236	0.244
E1	3.80	3.90	4.00	0.150	0.154	0.157
e		1.27			0.050	
h	0.25		0.50	0.010		0.020
L	0.40		1.27	0.016		0.050
L1		1.04			0.040	
k	1 °		8 °	1 °		8 °
ccc			0.10			0.004

5.6 MiniSO8 package information

Figure 30. MiniSO8 package mechanical drawing



Table 13. MiniSO8 package mechanical data

Ref.	Dimensions					
	Millimeters			Inches		
	Min.	Typ.	Max.	Min.	Typ.	Max.
A			1.1			0.043
A1	0		0.15	0		0.006
A2	0.75	0.85	0.95	0.030	0.033	0.037
b	0.22		0.40	0.009		0.016
c	0.08		0.23	0.003		0.009
D	2.80	3.00	3.20	0.11	0.118	0.126
E	4.65	4.90	5.15	0.183	0.193	0.203
E1	2.80	3.00	3.10	0.11	0.118	0.122
e		0.65			0.026	
L	0.40	0.60	0.80	0.016	0.024	0.031
L1		0.95			0.037	
L2		0.25			0.010	
k	0°		8°	0°		8°
ccc			0.10			0.004

5.7 MiniSO10 package information

Figure 31. MiniSO10 package mechanical drawing



Table 14. MiniSO10 package mechanical data

Ref.	Dimensions					
	Millimeters			Inches		
	Min.	Typ.	Max.	Min.	Typ.	Max.
A			1.10			0.043
A1	0.05	0.10	0.15	0.002	0.004	0.006
A2	0.78	0.86	0.94	0.031	0.034	0.037
b	0.25	0.33	0.40	0.010	0.013	0.016
c	0.15	0.23	0.30	0.006	0.009	0.012
D	2.90	3.00	3.10	0.114	0.118	0.122
E	4.75	4.90	5.05	0.187	0.193	0.199
E1	2.90	3.00	3.10	0.114	0.118	0.122
e		0.50			0.020	
L	0.40	0.55	0.70	0.016	0.022	0.028
L1		0.95			0.037	
k	0°	3°	6°	0°	3°	6°
aaa			0.10			0.004

5.8 SO14 package information

Figure 32. SO14 package mechanical drawing

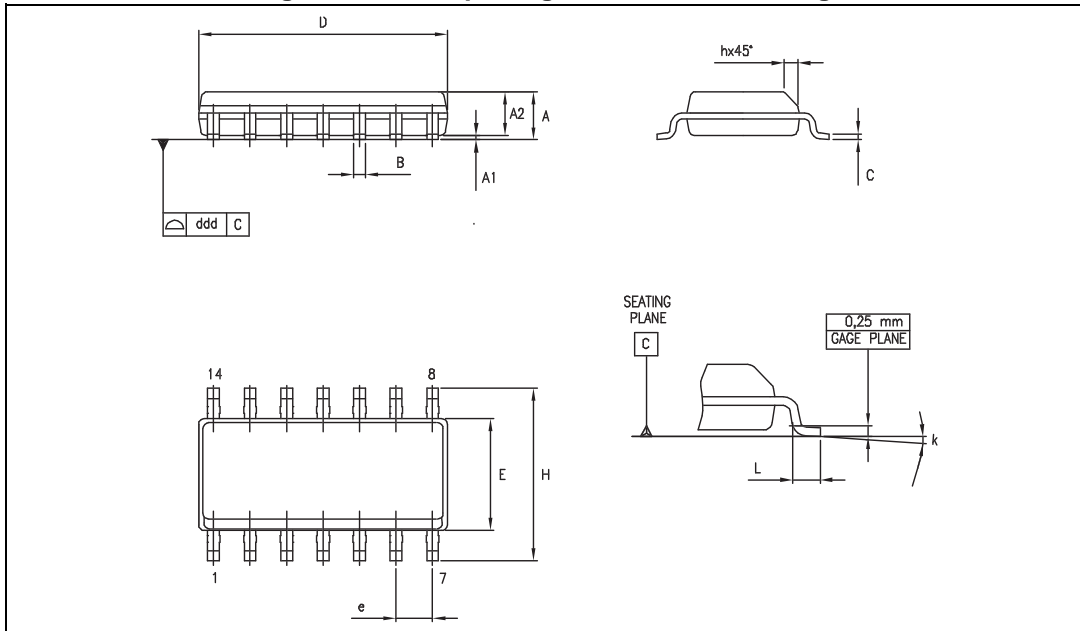

Table 15. SO14 package mechanical data

Dimensions						
Ref.	Millimeters			Inches		
	Min.	Typ.	Max.	Min.	Typ.	Max.
A	1.35		1.75	0.05		0.068
A1	0.10		0.25	0.004		0.009
A2	1.10		1.65	0.04		0.06
B	0.33		0.51	0.01		0.02
C	0.19		0.25	0.007		0.009
D	8.55		8.75	0.33		0.34
E	3.80		4.0	0.15		0.15
e		1.27			0.05	
H	5.80		6.20	0.22		0.24
h	0.25		0.50	0.009		0.02
L	0.40		1.27	0.015		0.05
k	8° (max.)					
ddd			0.10			0.004

5.9 TSSOP14 package information

Figure 33. TSSOP14 package mechanical drawing



Table 16. TSSOP14 package mechanical data

Ref.	Dimensions					
	Millimeters			Inches		
	Min.	Typ.	Max.	Min.	Typ.	Max.
A			1.20			0.047
A1	0.05		0.15	0.002	0.004	0.006
A2	0.80	1.00	1.05	0.031	0.039	0.041
b	0.19		0.30	0.007		0.012
c	0.09		0.20	0.004		0.0089
D	4.90	5.00	5.10	0.193	0.197	0.201
E	6.20	6.40	6.60	0.244	0.252	0.260
E1	4.30	4.40	4.50	0.169	0.173	0.176
e		0.65			0.0256	
L	0.45	0.60	0.75	0.018	0.024	0.030
L1		1.00			0.039	
k	0°		8°	0°		8°
aaa			0.10			0.004

5.10 TSSOP16 package information

Figure 34. TSSOP16 package mechanical drawing



Table 17. TSSOP16 package mechanical data

Ref.	Dimensions					
	Millimeters			Inches		
	Min.	Typ.	Max.	Min.	Typ.	Max.
A			1.20			0.047
A1	0.05		0.15	0.002		0.006
A2	0.80	1.00	1.05	0.031	0.039	0.041
b	0.19		0.30	0.007		0.012
c	0.09		0.20	0.004		0.008
D	4.90	5.00	5.10	0.193	0.197	0.201
E	6.20	6.40	6.60	0.244	0.252	0.260
E1	4.30	4.40	4.50	0.169	0.173	0.177
e		0.65			0.0256	
k	0°		8°	0°		8°
L	0.45	0.60	0.75	0.018	0.024	0.030
L1		1.00			0.039	
aaa			0.10			0.004

5.11 QFN16 3x3 package information

Figure 35. QFN16 3x3 package mechanical drawing



Table 18. QFN16 3x3 mm package mechanical data (pitch 0.5 mm)

Ref.	Dimensions					
	Millimeters			Inches		
	Min.	Typ.	Max.	Min.	Typ.	Max.
A	0.80	0.90	1.00	0.031	0.035	0.039
A1	0		0.05	0		0.002
A3		0.20			0.008	
b	0.18		0.30	0.007		0.012
D	2.90	3.00	3.10	0.114	0.118	0.122
D2	1.50		1.80	0.059		0.071
E	2.90	3.00	3.10	0.114	0.118	0.122
E2	1.50		1.80	0.059		0.071
e		0.50			0.020	
L	0.30		0.50	0.012		0.020

Figure 36. QFN16 3x3 footprint recommendation



6 Ordering information

Table 19. Order codes for devices without shutdown feature

Order code	Temperature range	Package	Packing	Marking
TSV851ICT	-40 °C to 125 °C	SC70-5	Tape and reel	K5E
TSV851ILT		SOT23-5		K153
TSV852IQ2T		DFN8 2x2		K5E
TSV852IST		MiniSO8		K153
TSV852IDT		SO8		TSV852I
TSV854IPT		TSSOP14		TSV854I
TSV854IDT		SO14		
TSV854IQ4T		QFN16 3x3		K157
TSV851AICT		SC70-5		K5F
TSV851AILT		SOT23-5		K154
TSV852AIST		MiniSO8		
TSV852AIDT		SO8		TSV852AI
TSV854AIPT		TSSOP14		TSV854AI
TSV854AIDT		SO14		

Table 20. Order codes for devices with shutdown feature

Order code	Temperature range	Package	Packing	Marking
TSV850ILT	-40 °C to 125 °C	SOT23-6	Tape and reel	K153
TSV853IST		MiniSO10		
TSV855IPT		TSSOP16		TSV855I
TSV850AILT		SOT23-6		K154
TSV853AIST		MiniSO10		
TSV855AIPT		TSSOP16		TSV855AI

Table 21. Order codes (automotive grade parts)

Order code	Temperature range	Package	Packing	Marking
TSV851IYLT	-40 °C to 125 °C automotive grade ⁽¹⁾	SOT23-5	Tape and reel	K165
TSV852IYST		MiniSO8		
TSV852IYDT		SO8		TSV852IY
TSV854IYPT		TSSOP14		TSV854IY
TSV851AIYLT		SOT23-5		K166
TSV852AIYST		MiniSO8		
TSV852AIYDT		SO8		TSV852AY
TSV854AIYPT		TSSOP14		TSV854AIY

1. Qualified and characterized according to AEC Q100 and Q003 or equivalent, advanced screening according to AEC Q001 and Q002 or equivalent.

7 Revision history

Table 22. Document revision history

Date	Revision	Changes
10-Nov-2011	1	Initial release.
06-Jul-2012	2	Added QFN16 package with related information. Minimum supply voltage decreased down to 2.3 V. Modified Figure 2, Figure 7 and Figure 14. Addition of automotive grade parts.
02-Oct-2013	3	Figure 1: Pin connections for each package (top view): added DFN8 2x2 pin connection to show exposed pad; added footnote 1. Section 4.7: Shutdown function: added explanation of Figure 23 and Figure 23. Table 21: Order codes (automotive grade parts): updated footnote 1. Updated disclaimer.
24-Apr-2017	4	Updated Table 11 : "L" dimension changed from 0.5 mm to 0.425 mm. Minor text edits throughout the document.

IMPORTANT NOTICE – PLEASE READ CAREFULLY

STMicroelectronics NV and its subsidiaries ("ST") reserve the right to make changes, corrections, enhancements, modifications, and improvements to ST products and/or to this document at any time without notice. Purchasers should obtain the latest relevant information on ST products before placing orders. ST products are sold pursuant to ST's terms and conditions of sale in place at the time of order acknowledgement.

Purchasers are solely responsible for the choice, selection, and use of ST products and ST assumes no liability for application assistance or the design of Purchasers' products.

No license, express or implied, to any intellectual property right is granted by ST herein.

Resale of ST products with provisions different from the information set forth herein shall void any warranty granted by ST for such product.

ST and the ST logo are trademarks of ST. All other product or service names are the property of their respective owners.

Information in this document supersedes and replaces information previously supplied in any prior versions of this document.

© 2017 STMicroelectronics – All rights reserved

Компания «Океан Электроники» предлагает заключение долгосрочных отношений при поставках импортных электронных компонентов на взаимовыгодных условиях!

Наши преимущества:

- Поставка оригинальных импортных электронных компонентов напрямую с производств Америки, Европы и Азии, а так же с крупнейших складов мира;
- Широкая линейка поставок активных и пассивных импортных электронных компонентов (более 30 млн. наименований);
- Поставка сложных, дефицитных, либо снятых с производства позиций;
- Оперативные сроки поставки под заказ (от 5 рабочих дней);
- Экспресс доставка в любую точку России;
- Помощь Конструкторского Отдела и консультации квалифицированных инженеров;
- Техническая поддержка проекта, помощь в подборе аналогов, поставка прототипов;
- Поставка электронных компонентов под контролем ВП;
- Система менеджмента качества сертифицирована по Международному стандарту ISO 9001;
- При необходимости вся продукция военного и аэрокосмического назначения проходит испытания и сертификацию в лаборатории (по согласованию с заказчиком);
- Поставка специализированных компонентов военного и аэрокосмического уровня качества (Xilinx, Altera, Analog Devices, Intersil, Interpoint, Microsemi, Actel, Aeroflex, Peregrine, VPT, Syfer, Eurofarad, Texas Instruments, MS Kennedy, Miteq, Cobham, E2V, MA-COM, Hittite, Mini-Circuits, General Dynamics и др.);

Компания «Океан Электроники» является официальным дистрибьютором и эксклюзивным представителем в России одного из крупнейших производителей разъемов военного и аэрокосмического назначения «JONHON», а так же официальным дистрибьютором и эксклюзивным представителем в России производителя высокотехнологичных и надежных решений для передачи СВЧ сигналов «FORSTAR».



JONHON

«JONHON» (основан в 1970 г.)

Разъемы специального, военного и аэрокосмического назначения:

(Применяются в военной, авиационной, аэрокосмической, морской, железнодорожной, горно- и нефтедобывающей отраслях промышленности)

«FORSTAR» (основан в 1998 г.)

ВЧ соединители, коаксиальные кабели, кабельные сборки и микроволновые компоненты:

(Применяются в телекоммуникациях гражданского и специального назначения, в средствах связи, РЛС, а так же военной, авиационной и аэрокосмической отраслях промышленности).



Телефон: 8 (812) 309-75-97 (многоканальный)

Факс: 8 (812) 320-03-32

Электронная почта: ocean@oceanchips.ru

Web: <http://oceanchips.ru/>

Адрес: 198099, г. Санкт-Петербург, ул. Калинина, д. 2, корп. 4, лит. А