

## FLORENTINA-1-D

~18° diffused spot beam

### TECHNICAL SPECIFICATIONS:

Dimensions	39.7 mm
Height	13 mm
Fastening	tape
ROHS compliant	yes ⓘ

### MATERIAL SPECIFICATIONS:

Component	Type	Material	Colour	Finish
ROSE-CMC-D	Single lens	PC	clear	
FLORENTINA-1-HLD	Holder	PC	black	
ROSE-TAPE	Tape	PU tape	black	

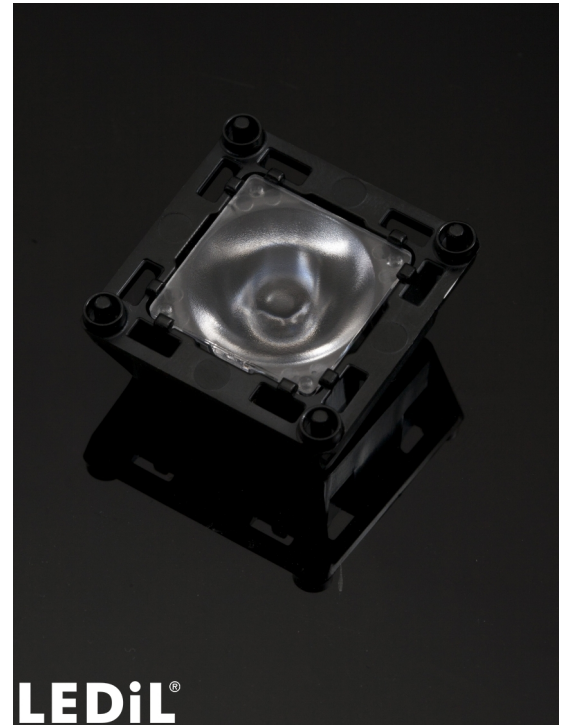





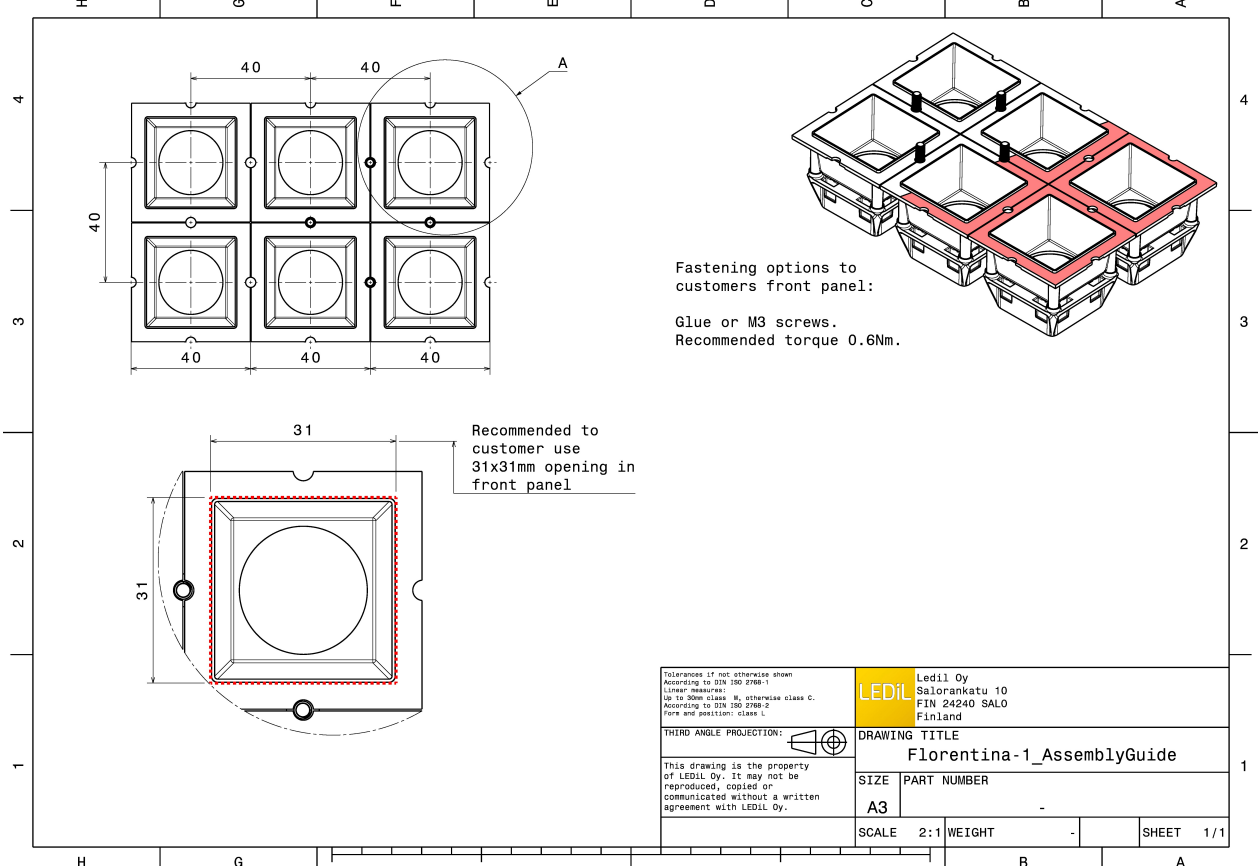
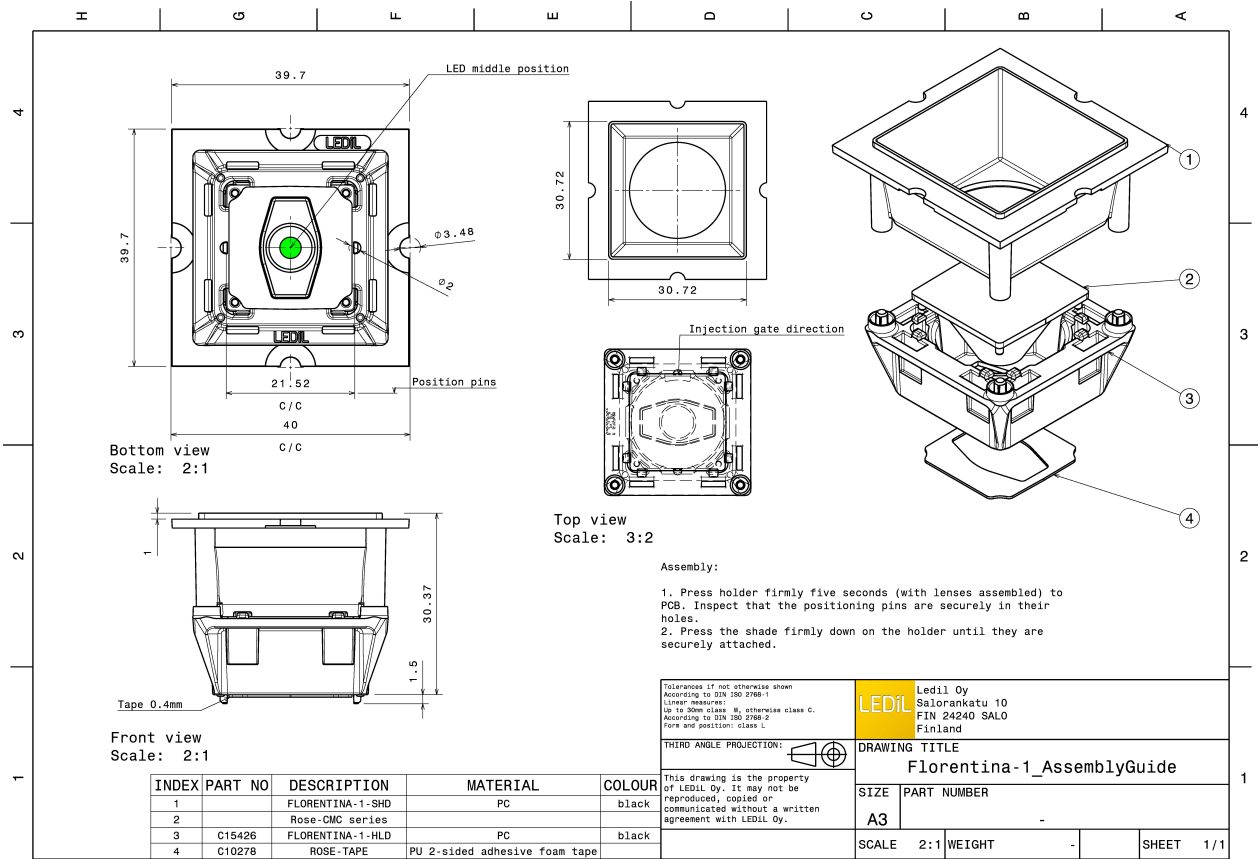

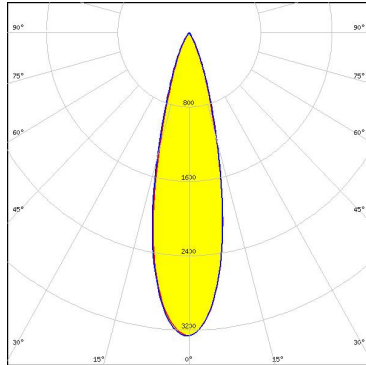

### ORDERING INFORMATION:

Component		Qty in box	MOQ	MPQ	Box weight (kg)
FCA15450_FLORENTINA-1-D	Single lens	840		60	7.9
» Box size: 480 x 280 x 300 mm					

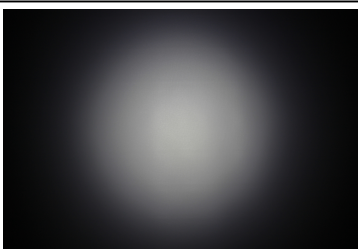
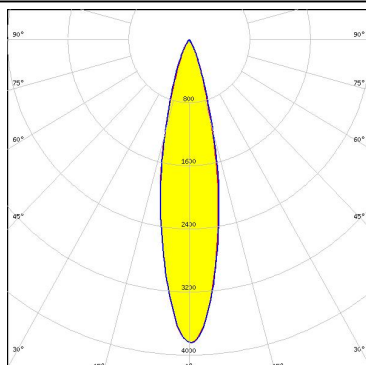

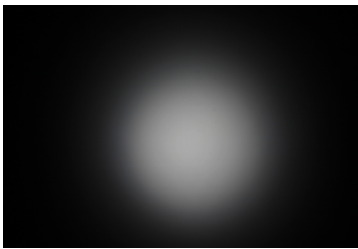
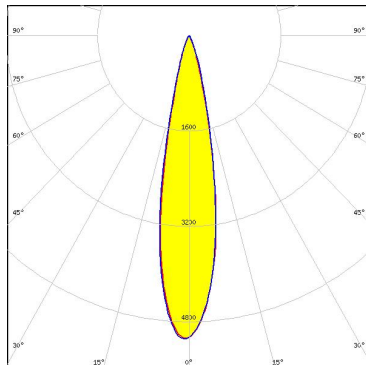
#### PHOTOMETRIC DATA (MEASURED):

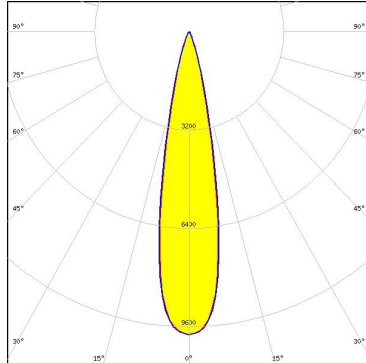
<p> <b>bridgelux</b></p> <p>LED                    Bridgelux SMD 5050            FWHM                26.0°            Efficiency            78 %            Peak intensity      3.3 cd/lm            LEDs/each optic    1            Light colour        White            Required components:                                      C15427_FLORENTINA-1-SHD-60</p>		
<p> <b>CREE</b></p> <p>LED                    XHP35 HD            FWHM                23.0°            Efficiency            77 %            Peak intensity      3.9 cd/lm            LEDs/each optic    1            Light colour        White            Required components:                                      C15427_FLORENTINA-1-SHD-60</p>		
<p> <b>CREE</b></p> <p>LED                    XHP35 HI            FWHM                21.0°            Efficiency            77 %            Peak intensity      5.1 cd/lm            LEDs/each optic    1            Light colour        White            Required components:</p>		
<p> <b>CREE</b></p> <p>LED                    XP-G2            FWHM                21.0°            Efficiency            77 %            Peak intensity      5.1 cd/lm            LEDs/each optic    1            Light colour        White            Required components:                                      C15427_FLORENTINA-1-SHD-60</p>		

#### PHOTOMETRIC DATA (MEASURED):



LED XP-L HD  
 FWHM 23.0°  
 Efficiency 76 %  
 Peak intensity 4.2 cd/lm  
 LEDs/each optic 1  
 Light colour White  
 Required components:  
 C15427\_FLORENTINA-1-SHD-60

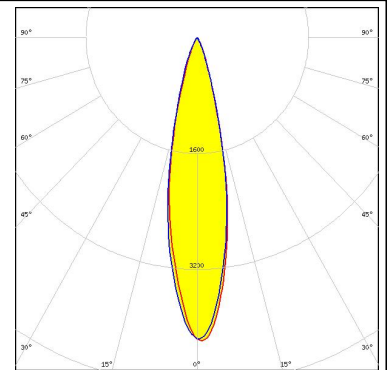

LED XP-L2  
 FWHM 23.0°  
 Efficiency 75 %  
 Peak intensity 3.9 cd/lm  
 LEDs/each optic 1  
 Light colour White  
 Required components:  
 C15427\_FLORENTINA-1-SHD-60

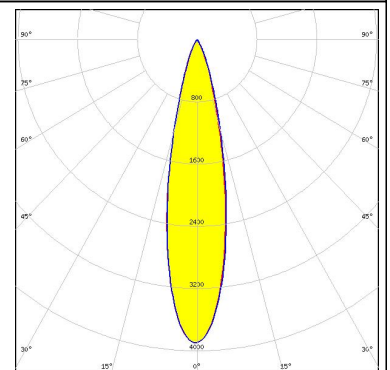



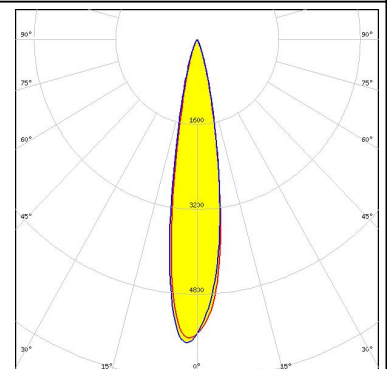
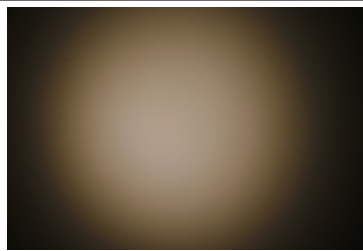

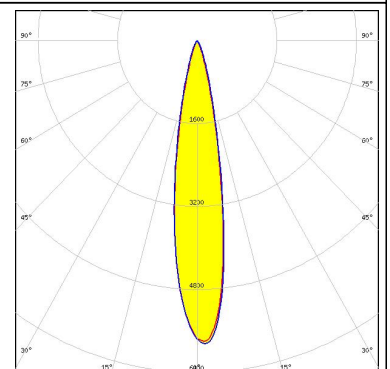

LED XT-E  
 FWHM 18.0°  
 Efficiency 76 %  
 Peak intensity 5.8 cd/lm  
 LEDs/each optic 1  
 Light colour White  
 Required components:  
 C15427\_FLORENTINA-1-SHD-60



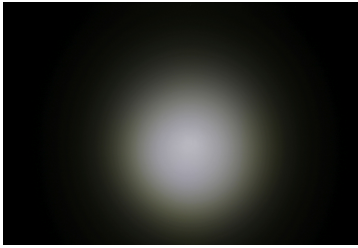
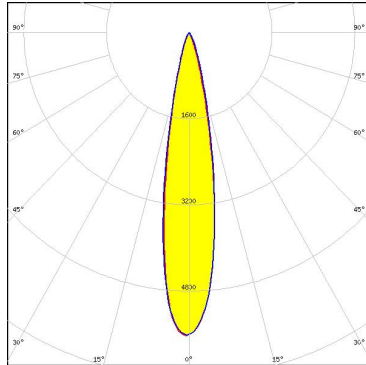

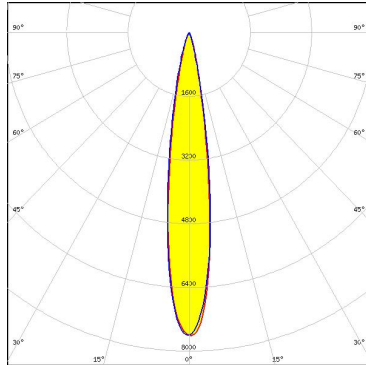
LED LG 5630  
 FWHM 19.0°  
 Efficiency 82 %  
 Peak intensity 5.9 cd/lm  
 LEDs/each optic 1  
 Light colour White  
 Required components:  
 C16701\_FLORENTINA-1-SHD-60-WHT

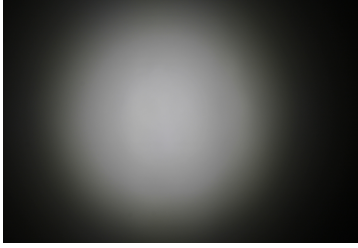
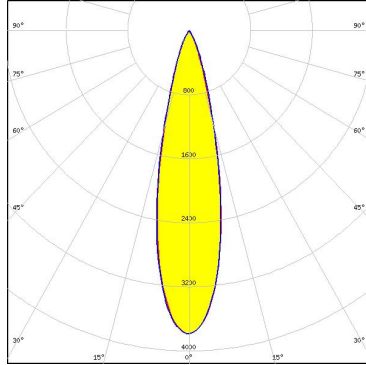

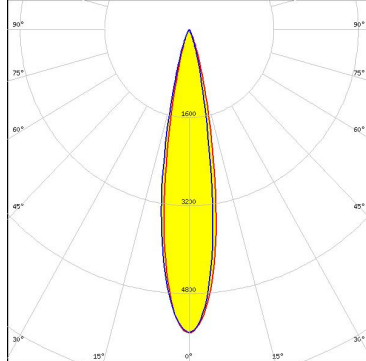
#### PHOTOMETRIC DATA (MEASURED):

<p> <b>LG Innotek</b></p> <p>LED LG 5630            FWHM 19.0°            Efficiency 81 %            Peak intensity 5.6 cd/lm            LEDs/each optic 1            Light colour White            Required components:            C15427_FLORENTINA-1-SHD-60</p>		
<p> <b>LUMILEDS</b></p> <p>LED LUXEON 3030 2D (Round LES)            FWHM 16.0°            Efficiency 79 %            Peak intensity 7.6 cd/lm            LEDs/each optic 1            Light colour White            Required components:</p>		
<p> <b>LUMILEDS</b></p> <p>LED LUXEON 5050 Round LES            FWHM 24.0°            Efficiency 79 %            Peak intensity 3.8 cd/lm            LEDs/each optic 1            Light colour White            Required components:            C15427_FLORENTINA-1-SHD-60</p>		
<p> <b>LUMILEDS</b></p> <p>LED LUXEON TX            FWHM 19.0°            Efficiency 77 %            Peak intensity 5.5 cd/lm            LEDs/each optic 1            Light colour White            Required components:            C15427_FLORENTINA-1-SHD-60</p>		

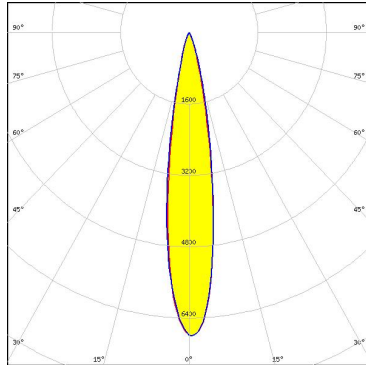
#### PHOTOMETRIC DATA (MEASURED):

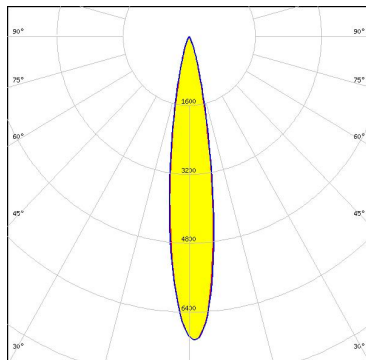
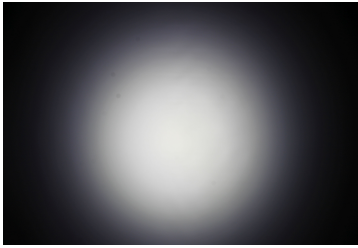
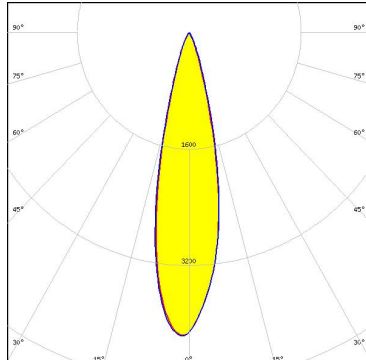
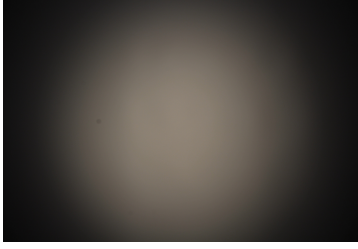
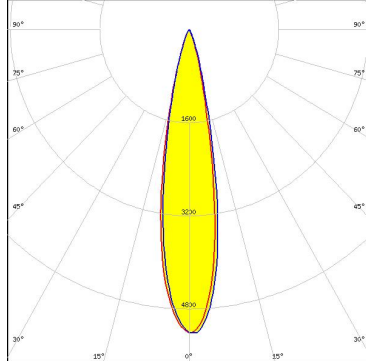
<p><b>NICHIA</b></p> <p>LED NF2x757G            FWHM 18.0°            Efficiency 82 %            Peak intensity 6.8 cd/lm            LEDs/each optic 1            Light colour White            Required components:            C16701_FLORENTINA-1-SHD-60-WHT</p>		
<p><b>NICHIA</b></p> <p>LED NF2x757G            FWHM 17.0°            Efficiency 81 %            Peak intensity 7.2 cd/lm            LEDs/each optic 1            Light colour White            Required components:            C15427_FLORENTINA-1-SHD-60</p>		
<p><b>NICHIA</b></p> <p>LED NVSW319B            FWHM 24.0°            Efficiency 79 %            Peak intensity 4.2 cd/lm            LEDs/each optic 1            Light colour White            Required components:            C15427_FLORENTINA-1-SHD-60</p>		
<p><b>NICHIA</b></p> <p>LED NVSxx19B/NVSxx19C            FWHM 20.0°            Efficiency 78 %            Peak intensity 5.2 cd/lm            LEDs/each optic 1            Light colour White            Required components:            C15427_FLORENTINA-1-SHD-60</p>		

#### PHOTOMETRIC DATA (MEASURED):

#### OSRAM

Opto Semiconductors

LED OSLOM Square CSSRM2/CSSRM3  
 FWHM 20.0°  
 Efficiency 79 %  
 Peak intensity 5.4 cd/lm  
 LEDs/each optic 1  
 Light colour White  
 Required components:  
 C15427\_FLORENTINA-1-SHD-60

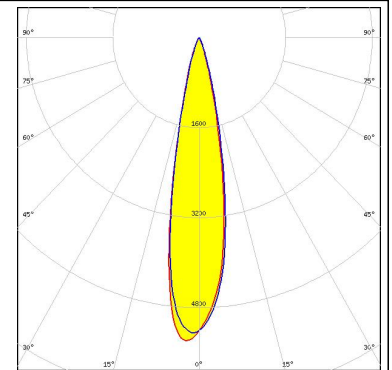
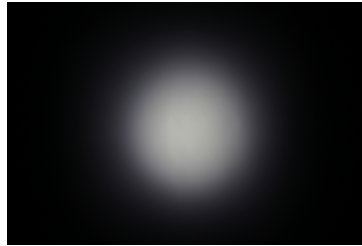

#### OSRAM

Opto Semiconductors

LED OSLOM SSL 150  
 FWHM 18.0°  
 Efficiency 77 %  
 Peak intensity 6.6 cd/lm  
 LEDs/each optic 1  
 Light colour White  
 Required components:  
 C15427\_FLORENTINA-1-SHD-60

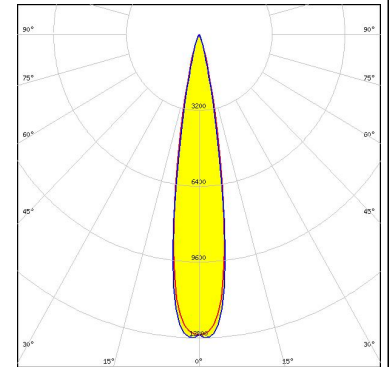

#### SAMSUNG

LED LM561B  
 FWHM 17.0°  
 Efficiency 80 %  
 Peak intensity 6.9 cd/lm  
 LEDs/each optic 1  
 Light colour White  
 Required components:  
 C15427\_FLORENTINA-1-SHD-60

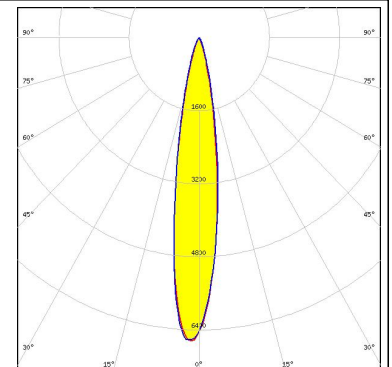
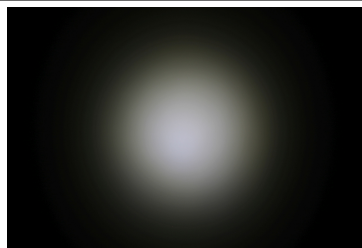

SEOUL SEMICONDUCTOR

LED SEOUL 5630  
 FWHM 16.0°  
 Efficiency 82 %  
 Peak intensity 7.4 cd/lm  
 LEDs/each optic 1  
 Light colour White  
 Required components:  
 C15427\_FLORENTINA-1-SHD-60

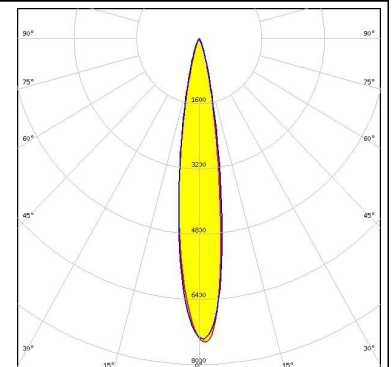

#### PHOTOMETRIC DATA (MEASURED):

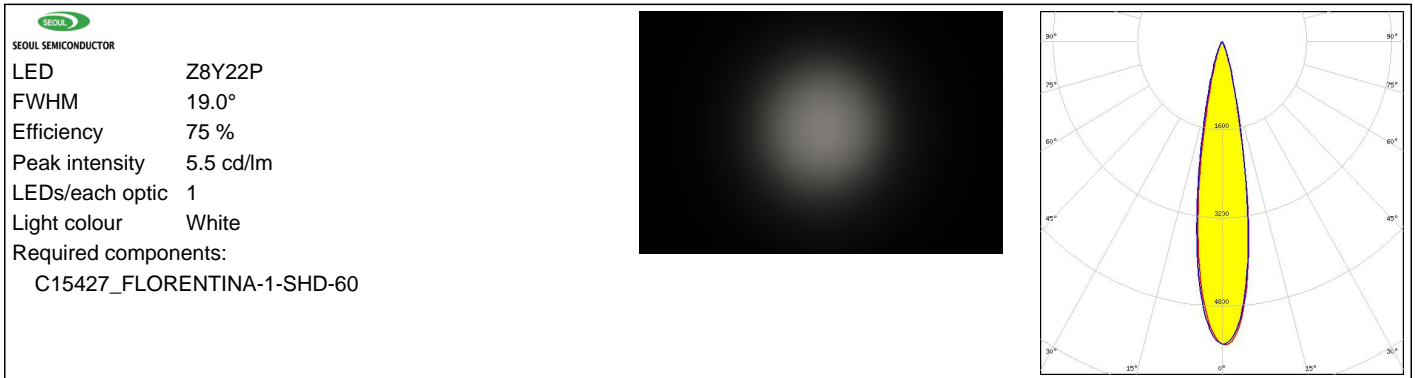



#### GENERAL INFORMATION:

NOTE: The typical beam angle will be changed by different color, chip size and chip position tolerance. The typical total beam angle is the full angle measured where the luminous intensity is half of the peak value.

#### MATERIALS:

As part of our continuous research and improvement processes, and to ensure the best possible quality and availability of our products, LEDiL reserves the right to change material grades without notice.

#### PRODUCT DATA USER AGREEMENT AND DISCLAIMER:

The measured data in the provided downloadable LEDiL Product Datasheets and Mechanical 2D-Drawings is rounded and provided as reference for planning. LEDiL Oy's optical specifications have been verified by conducting performance testing of the products in accordance with the company's quality system. The reported data are averaged results of multiple measurements with typical variation. LEDiL Oy reserves the right to without prior notification make changes and improvements to its products.

LEDiL Oy assumes neither warranty, nor guarantee nor any other liability of any kind for the contents and correctness of the provided data. The provided data has been generated with highest diligence but the provided data may in reality not represent the complete possible variation range of all intrinsic parameters. Therefore, in certain cases a deviation from the provided data could occur.

LEDiL Oy reserves the right to undertake technical changes of its products without further notification which could lead to changes in the provided data. LEDiL Oy assumes no liability of any kind for the possible deviation from any provided data or any other damage resulting from the usage of the provided data.

The user agrees to this disclaimer and user agreement with the download or usage of the provided files.

#### LEDiL Oy

Joensuunkatu 13  
FI-24240 SALO  
Finland

#### LEDiL Inc.

228 West Page Street  
Suite D  
Sycamore IL 60178  
USA

#### Local sales and technical support

[www.ledil.com/  
where\\_to\\_buy](http://www.ledil.com/where_to_buy)

#### Shipping locations

Salo, Finland  
Hong Kong, China

#### Distribution Partners

[www.ledil.com/  
where\\_to\\_buy](http://www.ledil.com/where_to_buy)

Компания «Океан Электроники» предлагает заключение долгосрочных отношений при поставках импортных электронных компонентов на взаимовыгодных условиях!

Наши преимущества:

- Поставка оригинальных импортных электронных компонентов напрямую с производств Америки, Европы и Азии, а так же с крупнейших складов мира;
- Широкая линейка поставок активных и пассивных импортных электронных компонентов (более 30 млн. наименований);
- Поставка сложных, дефицитных, либо снятых с производства позиций;
- Оперативные сроки поставки под заказ (от 5 рабочих дней);
- Экспресс доставка в любую точку России;
- Помощь Конструкторского Отдела и консультации квалифицированных инженеров;
- Техническая поддержка проекта, помощь в подборе аналогов, поставка прототипов;
- Поставка электронных компонентов под контролем ВП;
- Система менеджмента качества сертифицирована по Международному стандарту ISO 9001;
- При необходимости вся продукция военного и аэрокосмического назначения проходит испытания и сертификацию в лаборатории (по согласованию с заказчиком);
- Поставка специализированных компонентов военного и аэрокосмического уровня качества (Xilinx, Altera, Analog Devices, Intersil, Interpoint, Microsemi, Actel, Aeroflex, Peregrine, VPT, Syfer, Eurofarad, Texas Instruments, MS Kennedy, Miteq, Cobham, E2V, MA-COM, Hittite, Mini-Circuits, General Dynamics и др.);

Компания «Океан Электроники» является официальным дистрибьютором и эксклюзивным представителем в России одного из крупнейших производителей разъемов военного и аэрокосмического назначения «JONHON», а так же официальным дистрибьютором и эксклюзивным представителем в России производителя высокотехнологичных и надежных решений для передачи СВЧ сигналов «FORSTAR».



## JONHON

«JONHON» (основан в 1970 г.)

Разъемы специального, военного и аэрокосмического назначения:

(Применяются в военной, авиационной, аэрокосмической, морской, железнодорожной, горно- и нефтедобывающей отраслях промышленности)

«FORSTAR» (основан в 1998 г.)

ВЧ соединители, коаксиальные кабели, кабельные сборки и микроволновые компоненты:

(Применяются в телекоммуникациях гражданского и специального назначения, в средствах связи, РЛС, а так же военной, авиационной и аэрокосмической отраслях промышленности).



Телефон: 8 (812) 309-75-97 (многоканальный)

Факс: 8 (812) 320-03-32

Электронная почта: [ocean@oceanchips.ru](mailto:ocean@oceanchips.ru)

Web: <http://oceanchips.ru/>

Адрес: 198099, г. Санкт-Петербург, ул. Калинина, д. 2, корп. 4, лит. А