

# Using the TPS84410EVM-001, TPS84210EVM-002, TPS84610EVM-003

## User's Guide



Literature Number: SLUU633A  
September 2011–Revised February 2012

# **TPS84410EVM-001/TPS84210EVM-002/TPS84610EVM-003, 2-A to 6-A Integrated Power Solution**

---



---



---

## **1 Introduction**

The TPS84410EVM-001, TPS84210EVM-002, TPS84610EVM-003 Evaluation Module (TPS84x10EVM-00x) is designed as an easy to use platform that facilitates an extensive evaluation of the features and performance of the Integrated Power Solution (IPS) devices. The EVM PCB may be configured with one of three IPS devices (see [Table 1](#)).

**Table 1. TPS84x10EVM-00x Device Configuration**

DEVICE	TITLE
TPS84210	6-V input, 2-A output sync. step-down converter with PWM
TPS84410	6-V input, 4-A output sync. step-down converter with PWM
TPS84610	6-V input, 6-A output sync. step-down converter with PWM

This user guide provides information on the correct usage of the EVM and an explanation of the numerous test points on the board.

## **2 Description**

The EVM features a TPS84x10 synchronous buck IPS device configured for operation with typical 3.3-V and 5-V input bus applications. The output voltage can be set to one of five popular values by using a simple configuration jumper. In similar fashion, the switching frequency can be set to one of four values by use of a jumper. The full 4-A rated output current can be supplied by the EVM. A minimal amount of input and output capacitance is used on the board. Component pads are provided for additional input and output capacitors if desired. Monitoring test points are provided to allow measurement of efficiency, power dissipation, input ripple, output ripple, line and load regulation, and transient response. Control test points are provided for use of the PWRGD, Inhibit/UVLO, synchronization, and slow-start/tracking features of the IPS device. The EVM uses a recommended PCB layout that maximizes thermal performance and minimizes output ripple and noise.

### 3 Getting Started

Figure 1 highlights the user interface items associated with the EVM. The polarized  $V_{IN}$  Power terminal block is used for connection to the host input supply and the polarized  $V_{OUT}$  Power terminal block is used for connection to the load. The terminal blocks can accept up to 16 AWG wire.

The  $V_{IN}$  monitor and  $V_{OUT}$  monitor test points located near the power terminal blocks are intended to be used as voltage monitoring points where voltmeters can be connected to measure  $V_{IN}$  and  $V_{OUT}$ . The voltmeter references should be connected to any of the four  $V_{IN}/V_{OUT}$  monitor grounds test points located between the power terminal blocks. Do not use these  $V_{IN}$  and  $V_{OUT}$  monitoring test points as the input supply or output load connection points. The PCB traces connecting to these test points are not designed to support high currents.

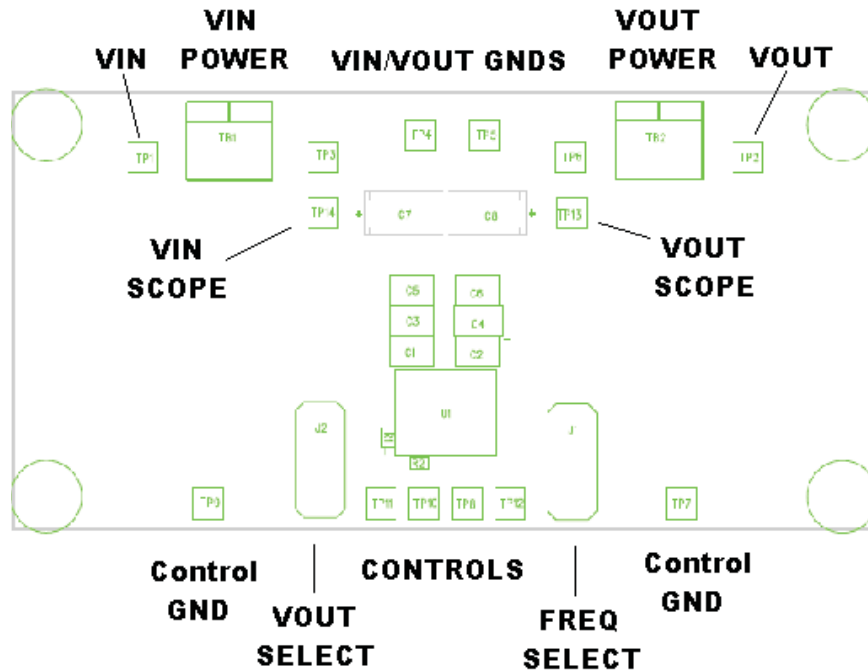
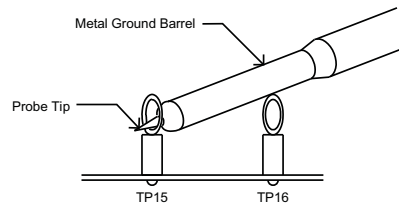

Figure 1. TPS84x10EVM-00x User Interface

The  $V_{IN}$  scope and  $V_{OUT}$  scope test points can be used to monitor  $V_{IN}$  and  $V_{OUT}$  waveforms with an oscilloscope. These test points are intended for use with un-hooded scope probes. The scope probe tip should be connected to the socket labeled VIN or VOUT, and the scope ground barrel should lean against to the test point labeled GND. The GND TP may need to be cut or bent slightly to hold the probe barrel.



**Figure 2. Tip and Barrel Measurement**

The control test points located directly below the TPS84x10 IPS device are made available to test the features of the device. Any external connections made to these test points should be referenced to either of the two control ground test points located along the bottom of the EVM. Refer to [Section 4](#) of this user guide for more information on the individual control test points.

The  $V_{OUT}$ -select and  $F_{SW}$ -select configuration jumpers are provided for selecting the desired output voltage and appropriate switching frequency. Before applying power to the EVM, ensure that the jumpers are present and properly positioned for the intended output voltage. Refer to [Table 2](#) for the recommended jumper settings. Always remove input power before changing the jumper settings.

Once the jumper settings have been confirmed, configure the host input supply to apply the appropriate bus voltage listed in [Table 2](#) and confirm that the selected output voltage is obtained.

**Table 2. Output Voltage and Switching Frequency Jumper Settings**

$V_{OUT}$ SELECT	TPS84210, $F_{SW}$ SELECT	TPS84410, $F_{SW}$ SELECT	TPS84610, $F_{SW}$ SELECT	$V_{IN}$ BUS VOLTAGE
3.3 V	1.5 MHz	1 MHz	-	5 V
2.5 V	1.5 MHz	1 MHz	-	5 V
1.8 V	1 MHz	1 MHz	-	5 V or 3.3 V
1.2 V	750 kHz	750 kHz	-	5 V or 3.3 V
0.8 V	650 kHz	650 kHz	-	5 V or 3.3 V

## 4 Test Point Descriptions

Fourteen wire-loop test points have been provided as convenient connection points for digital voltmeters (DVM) or oscilloscope probes to aid in the evaluation of the IPS device. A via labeled PH is available near U1 to scope on the switching frequency. A description of each test point is listed in [Table 3](#)

**Table 3. Test Point Descriptions**

TEST POINT	DESCRIPTION
VIN	Input voltage monitor. Connect DVM to this point for measuring efficiency.
VOUT	Output voltage monitor. Connect DVM to this point for measuring efficiency, line regulation, and load regulation.
GND	Input and output voltage monitor grounds (located between terminal blocks). Reference the above DVMs to any of these four ground points.
VIN (scope)	Input voltage scope monitor. Connect an oscilloscope to this set of points to measure input ripple voltage.
VOUT (scope)	Output voltage scope monitor. Connect an oscilloscope to this set of points to measure output ripple voltage and transient response.
PWRGD	Monitors the power good signal of the IPS device. This is an open drain signal that requires an external pull-up resistor to $V_{IN}$ if monitoring is desired. A 10-k $\Omega$ to 100-k $\Omega$ pull-up resistor is recommended. PWRGD is high if the output voltage is within 92% to 106% of its nominal value.
INH/UVLO	Connect this point to control ground to inhibit the IPS device. Allow this point to float to enable the device. Do not use a pull-up resistor. An external resistor can be connected from this point to control ground to increase the under-voltage lockout (UVLO) of the device.
RT/CLK	Connects to the RT/CLK pin of the IPS device. An external clock signal can be applied to this point to synchronize the device to an appropriate frequency.
SS/TR	Connects to the internal slow-start capacitor of the IPS device. An external capacitor can be connected from this point to control ground to increase the slow-start time of the device. This point can also be used as an input for tracking applications.
GND	Control grounds (located along bottom of EVM). Reference any signals associated with the control test points to either of these two ground points.

## 5 Operation Notes

The UVLO threshold of the factory-stock EVM is approximately 3.05 V with 0.3 V of hysteresis. The input voltage must be above the UVLO threshold in order to startup the IPS device. The UVLO threshold can be increased by adding a resistor to the INH/UVLO test point as described above. After startup, the minimum input voltage to the IPS device must be at least 2.95 V or ( $V_{OUT} + 1.1$  V), whichever is greater, in order to produce a regulated output. The maximum operating input voltage for the IPS device is 6 V. Refer to the [TPS84410 datasheet](#) for further information on the input voltage range and UVLO operation.

After application of the proper input voltage, the output voltage of the IPS device will ramp to its final value in approximately 1 ms. If desired, this soft-start time can be increased by adding a capacitor to the SS/TR test point as described above. Refer to the [TPS84410 datasheet](#) for further information on adjusting the soft-start time.

[Table 1](#) lists the recommended switching frequencies for each of the  $V_{OUT}$  selections. These recommendations cover operation over a wide range of input voltage and output load conditions. Several factors such as duty cycle, minimum on-time, minimum off-time, and current limit influence selection of the appropriate switching frequency. In some applications, other switching frequencies might be used for particular output voltages, depending on the above factors. Refer to the [TPS84410 datasheet](#) for further information on switching frequency selection, including synchronization.

6 TPS84x10EVM-00x Schematic

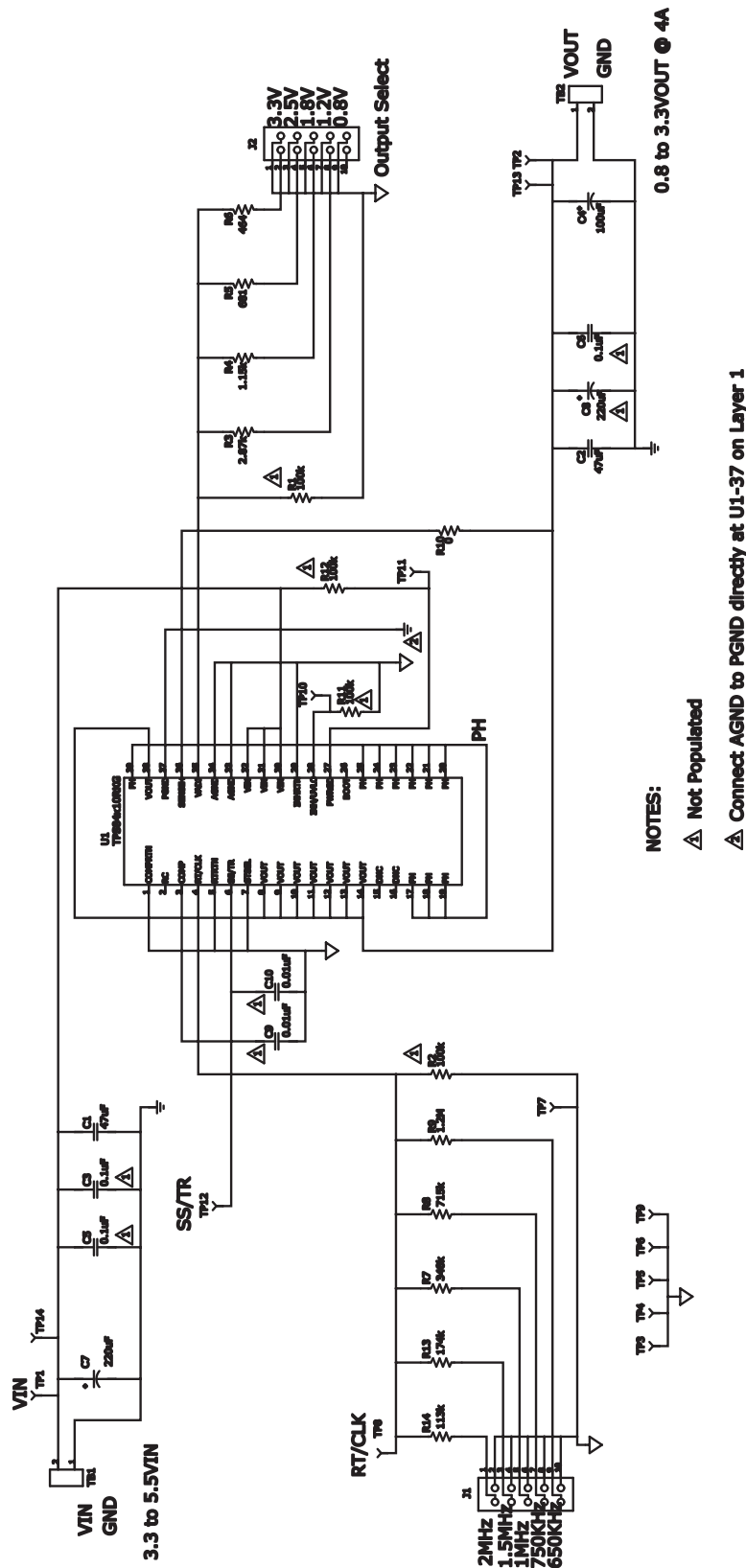

Figure 3. TPS84x10EVM-00x Schematic

## 7 PCB Layouts

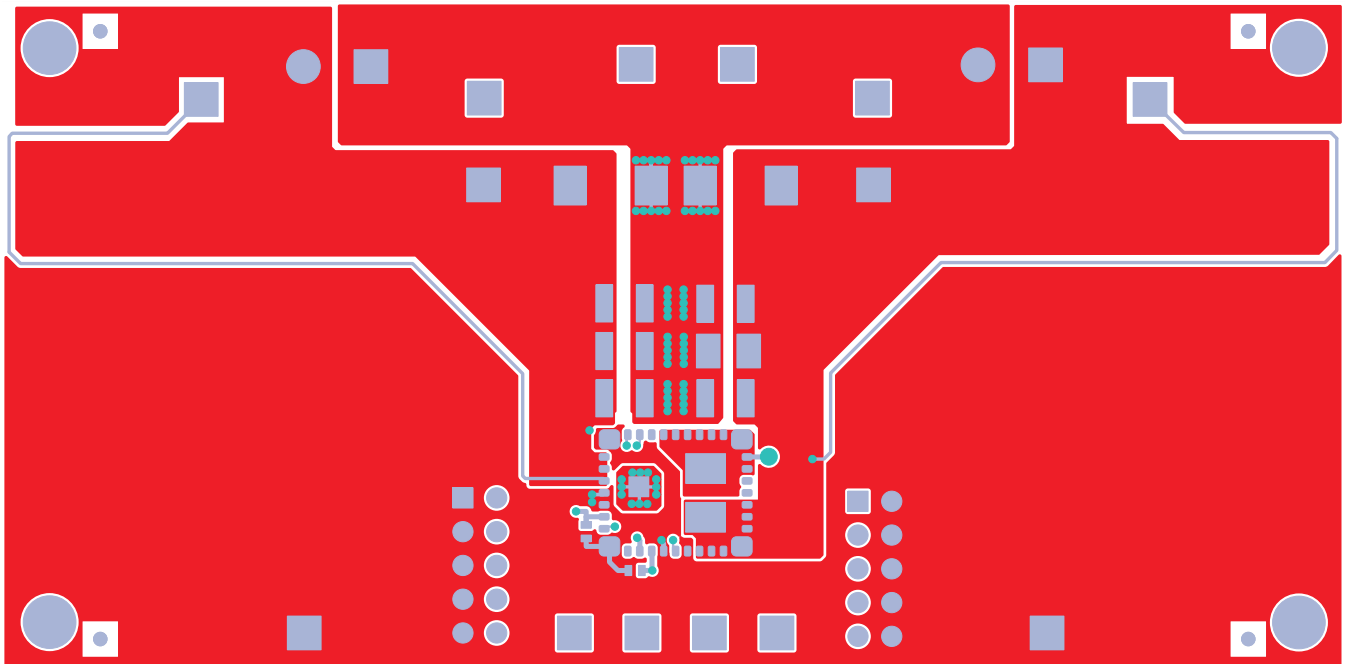

Figure 4. Top Layer

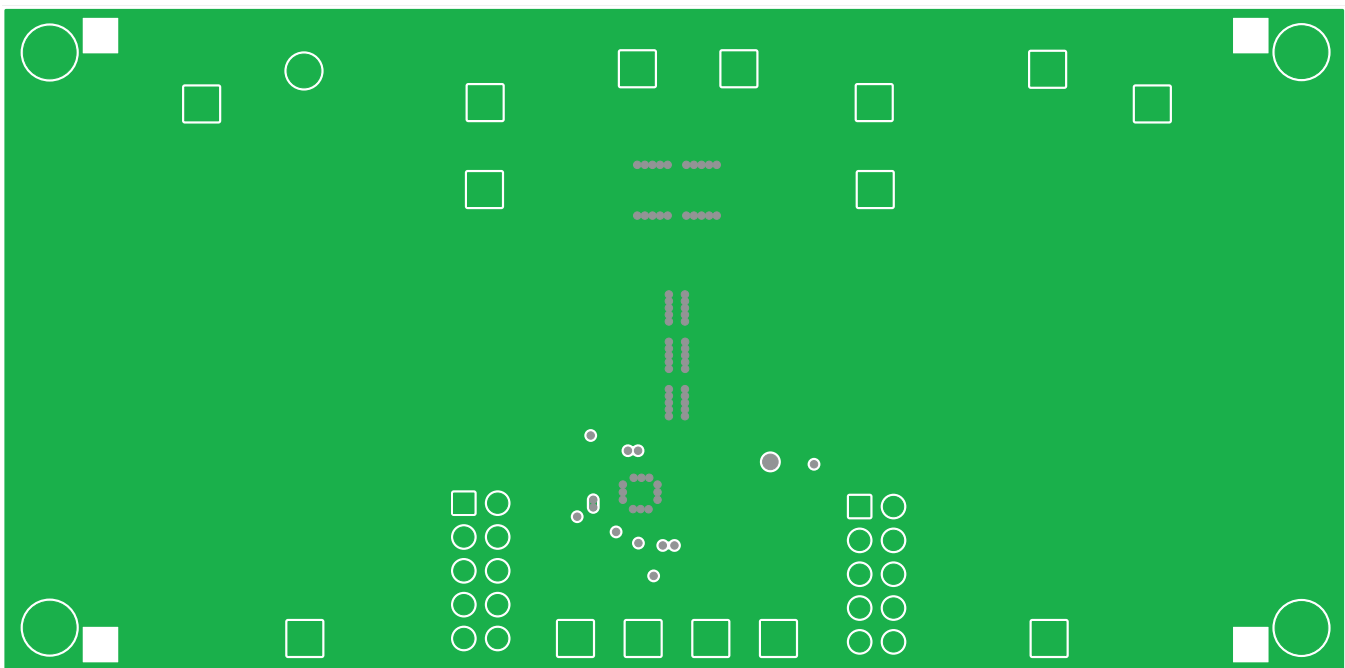

Figure 5. Internal 1 Layer

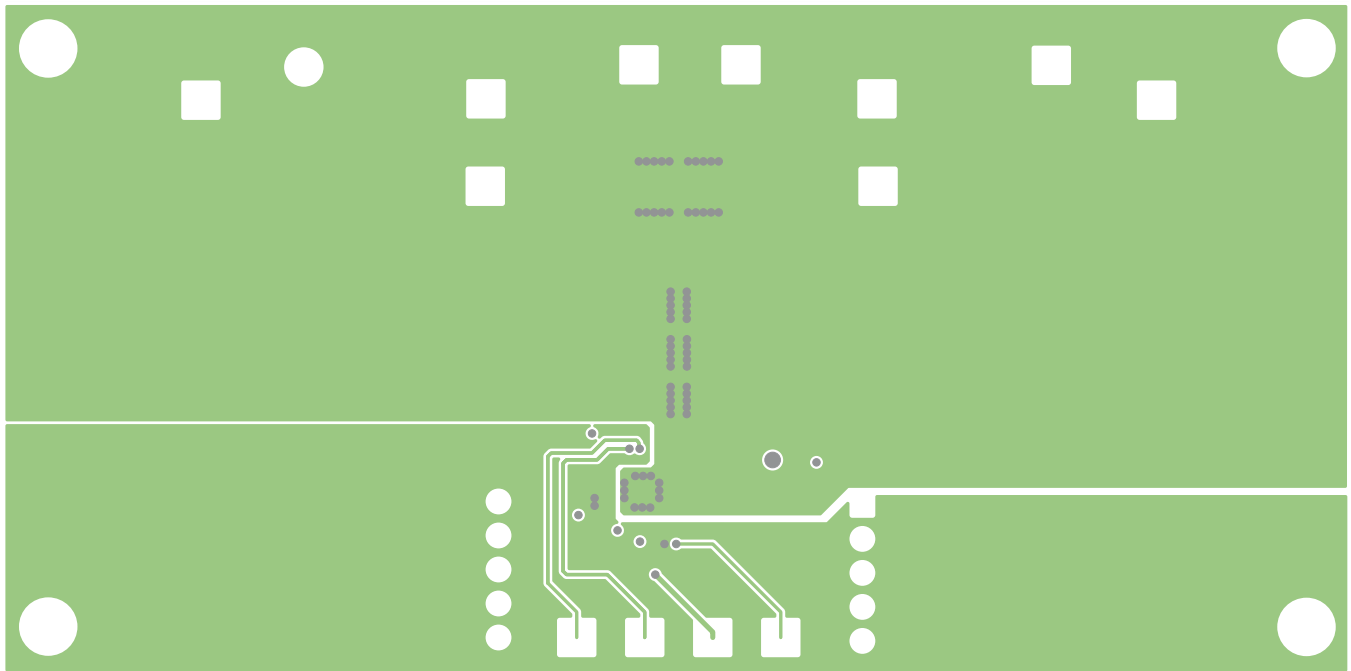

Figure 6. Internal 2 Layer

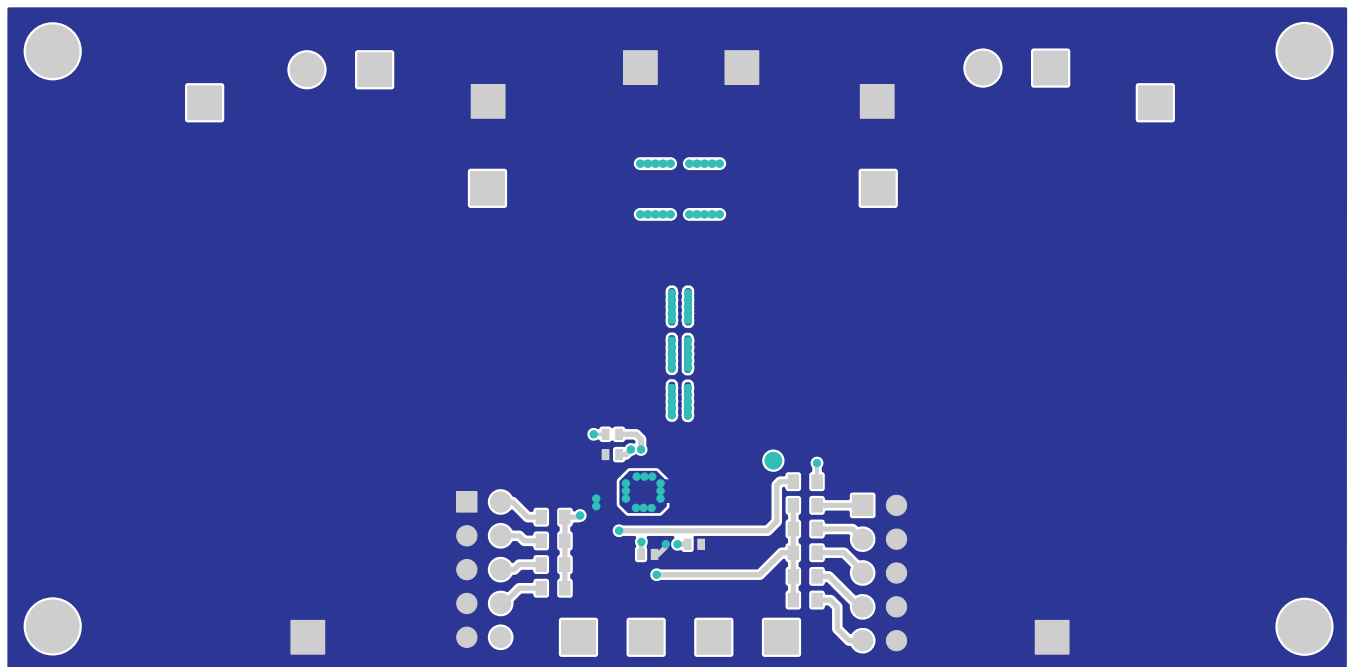
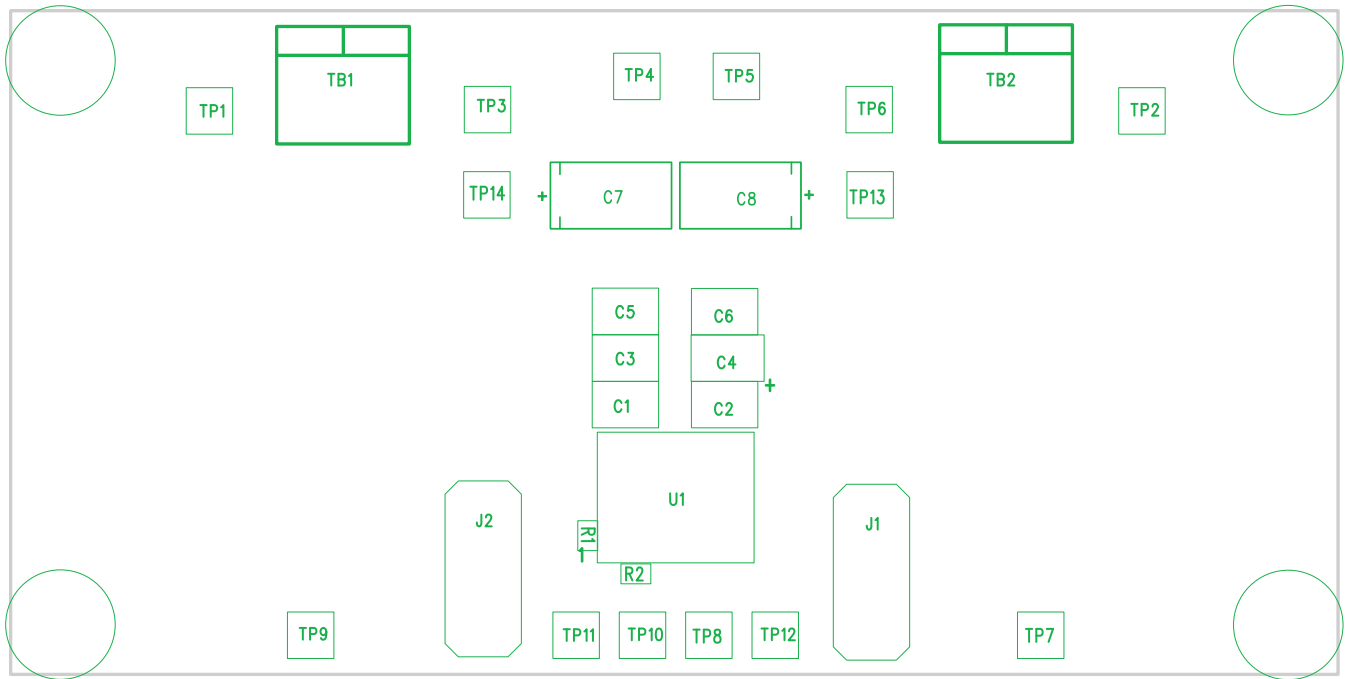
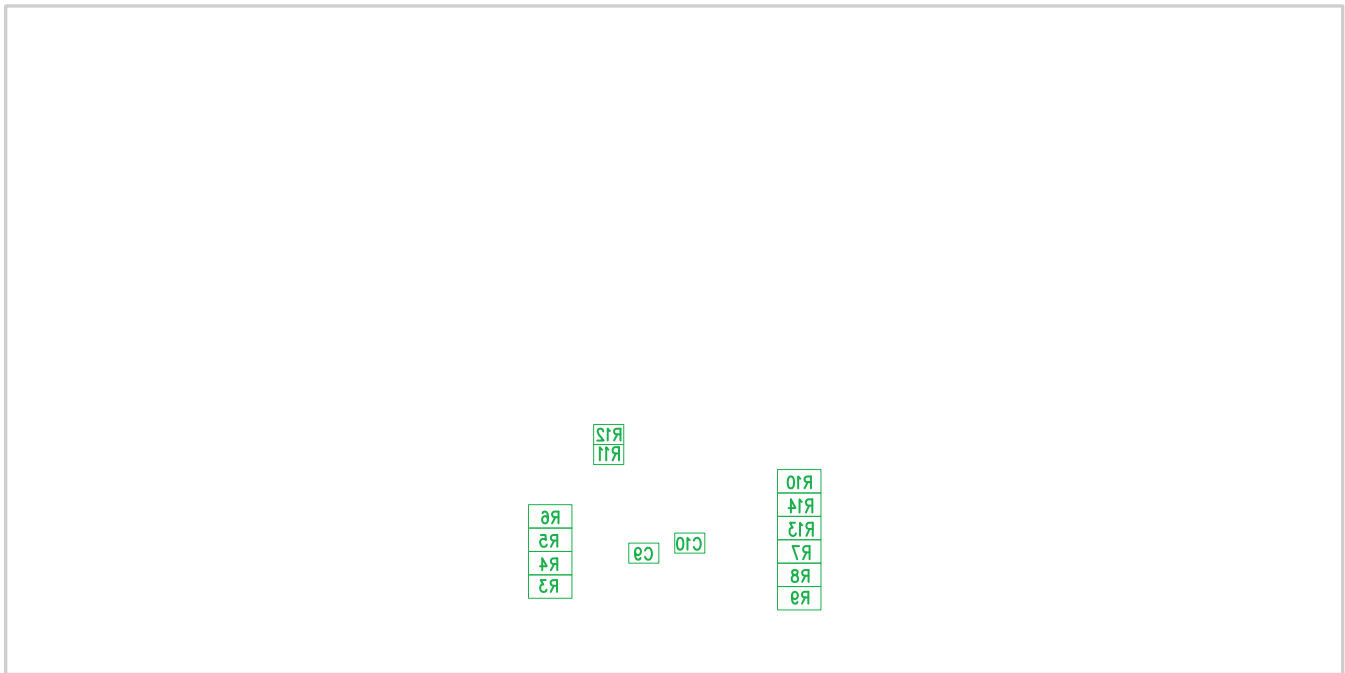

Figure 7. Bottom Layer





**Figure 8. Top Assembly**



**Figure 9. Bottom Layer**

## 8 List of Material

**Table 4. TPS84x10EVM-00x List of Material<sup>(1)(2)(3)(4)(5)</sup>**

-003	-002	-001	REF DES	DESCRIPTION	Part Number	MFR
1	1	1	C1	Capacitor, ceramic, 10 V, x5R, 10%, 47 $\mu$ F, 1210	GRM32ER61A476K	Murata
1	1	1	C2	Capacitor, ceramic, 6.3 V, x5R, 20%, 47 $\mu$ F, 1210	GRM32ER60J476M	Murata
1	1	1	C7	Capacitor, polymer, 10 V, 20%, 220 $\mu$ F, D3L	10TPE220ML	Sanyo
0	0	0	C8	Capacitor, polymer, 10 V, 20%, 220 $\mu$ F, D3L	10TPE220ML	Sanyo
1	1	1	C4	Capacitor, polymer, 6.3 V, 20%, 100 $\mu$ F, B2	6TPE100MPB	Sanyo
0	0	0	C3, C5, C6	Capacitor, ceramic, 0.1 $\mu$ F, 1210	Std	STD
0	0	0	10	Capacitor, ceramic, 0.01 $\mu$ F, 0402	STD	STD
2	2	2	J1-2	Header, male 2 x 5 pin, 100-mil spacing, 0.100 inch x 5 inch x 2 inch	PEC05DAAN	Sullins
1	1	1	R3	Resistor, chip, 1/16 W, 1%, 2.87 k $\Omega$ , 0603	STD	STD
1	1	1	R4	Resistor, chip, 1/16 W, 1%, 1.15 k $\Omega$ , 0603	STD	STD
1	1	1	R5	Resistor, chip, 1/16 W, 1%, 681 $\Omega$ , 0603	STD	STD
1	1	1	R6	Resistor, chip, 1/16 W, 1%, 464 $\Omega$ , 0603	STD	STD
1	1	1	R7	Resistor, chip, 1/16 W, 1%, 348 k $\Omega$ , 0603	STD	STD
1	1	1	R8	Resistor, chip, 1/16 W, 1%, 715 k $\Omega$ , 0603	STD	STD
1	1	1	R9	Resistor, chip, 1/16 W, 1%, 1.2 M $\Omega$ , 0603	STD	STD
1	1	1	R10	Resistor, chip, 1/16 W, 5%, 0 $\Omega$ , 0603	STD	STD
1	1	1	R13	Resistor, chip, 1/16 W, 1%, 174 k $\Omega$ , 0603	STD	STD
1	1	1	R14	Resistor, chip, 1/16 W, 1%, 113 k $\Omega$ , 0603	STD	STD
0	0	0	R1, R2, R11, R12	Resistor, chip, 1/16 W, 1%, 100 k $\Omega$ , 0402	Std	Std

<sup>(1)</sup> These assemblies are ESD sensitive, ESD precautions shall be observed.

<sup>(2)</sup> These assemblies must be clean and free from flux and all contaminants. Use of no clean flux is not acceptable.

<sup>(3)</sup> These assemblies must comply with workmanship standards IPC-A-610 Class 2.

<sup>(4)</sup> Ref designators marked with an asterisk (\*\*\*) cannot be substituted. All other components can be substituted with equivalent MFG's component.

<sup>(5)</sup> Install label after final wash. Text shall be 8 pt font. Text shall be per [Table 5](#).

**Table 4. TPS84x10EVM-00x List of Material<sup>(1)(2)(3)(4)(5)</sup> (continued)**

-003	-002	-001	REF DES	DESCRIPTION	Part Number	MFR
2	2	2	TB1-2	Terminal block, 2 pin, 15 A, 5.1 mm, 0.40 inch x 0.35 inch	ED120/2DS	OST
8	8	8	TP1, TP2 TP8 TP10- TP14	Test point, white, thru hole, 5012, 0.125 inch x 0.125 inch	5012	Keystone
6	6	6	TP3-7 TP9	Test point, black, thru hole, 5011, 0.125 inch x 0.125 inch	5011	Keystone
0	0	1	U1	6-V input, 4-A Output Sync. Step-Down Converter with PWM, QFN	TPS84410RKG	TI
0	1	0	U1	6-V input, 2-A Output Sync. Step-Down Converter with PWM, QFN	TPS84210RKG	TI
1	0	0	U1	6-V input, 6-A Output Sync. Step-Down Converter with PWM, QFN	TPS84610RKG	TI
1	1	1		PCB, 0.063 inch H x 1.9 inch L x 3.9 inch W	PWR059	ANY
2	2	2		Conn jumper shorting gold flash	SPC02SYAN	Sullins
4	4	4		Bumpon hemisphere 0.44 inch x 0.20 inch clear, 0.440 inch Dia x 0.200 inch H	SJ-5303	3M

**Table 5. Labeling**

ASSEMBLY NUMBER	TEXT
PWR059-001	TPS84410EVM-001
PWR059-002	TPS84210EVM-002
PWR059-003	TPS84610EVM-003

## Evaluation Board/Kit Important Notice

Texas Instruments (TI) provides the enclosed product(s) under the following conditions:

This evaluation board/kit is intended for use for **ENGINEERING DEVELOPMENT, DEMONSTRATION, OR EVALUATION PURPOSES ONLY** and is not considered by TI to be a finished end-product fit for general consumer use. Persons handling the product(s) must have electronics training and observe good engineering practice standards. As such, the goods being provided are not intended to be complete in terms of required design-, marketing-, and/or manufacturing-related protective considerations, including product safety and environmental measures typically found in end products that incorporate such semiconductor components or circuit boards. This evaluation board/kit does not fall within the scope of the European Union directives regarding electromagnetic compatibility, restricted substances (RoHS), recycling (WEEE), FCC, CE or UL, and therefore may not meet the technical requirements of these directives or other related directives.

Should this evaluation board/kit not meet the specifications indicated in the User's Guide, the board/kit may be returned within 30 days from the date of delivery for a full refund. **THE FOREGOING WARRANTY IS THE EXCLUSIVE WARRANTY MADE BY SELLER TO BUYER AND IS IN LIEU OF ALL OTHER WARRANTIES, EXPRESSED, IMPLIED, OR STATUTORY, INCLUDING ANY WARRANTY OF MERCHANTABILITY OR FITNESS FOR ANY PARTICULAR PURPOSE.**

The user assumes all responsibility and liability for proper and safe handling of the goods. Further, the user indemnifies TI from all claims arising from the handling or use of the goods. Due to the open construction of the product, it is the user's responsibility to take any and all appropriate precautions with regard to electrostatic discharge.

**EXCEPT TO THE EXTENT OF THE INDEMNITY SET FORTH ABOVE, NEITHER PARTY SHALL BE LIABLE TO THE OTHER FOR ANY INDIRECT, SPECIAL, INCIDENTAL, OR CONSEQUENTIAL DAMAGES.**

TI currently deals with a variety of customers for products, and therefore our arrangement with the user **is not exclusive.**

TI assumes **no liability for applications assistance, customer product design, software performance, or infringement of patents or services described herein.**

Please read the User's Guide and, specifically, the Warnings and Restrictions notice in the User's Guide prior to handling the product. This notice contains important safety information about temperatures and voltages. For additional information on TI's environmental and/or safety programs, please contact the TI application engineer or visit [www.ti.com/esh](http://www.ti.com/esh).

No license is granted under any patent right or other intellectual property right of TI covering or relating to any machine, process, or combination in which such TI products or services might be or are used.

## FCC Warning

This evaluation board/kit is intended for use for **ENGINEERING DEVELOPMENT, DEMONSTRATION, OR EVALUATION PURPOSES ONLY** and is not considered by TI to be a finished end-product fit for general consumer use. It generates, uses, and can radiate radio frequency energy and has not been tested for compliance with the limits of computing devices pursuant to part 15 of FCC rules, which are designed to provide reasonable protection against radio frequency interference. Operation of this equipment in other environments may cause interference with radio communications, in which case the user at his own expense will be required to take whatever measures may be required to correct this interference.

## EVM Warnings and Restrictions

It is important to operate this EVM within the input voltage range of 3 V to 6 V and the output voltage range of 0.8 V to 3.6 V .

Exceeding the specified input range may cause unexpected operation and/or irreversible damage to the EVM. If there are questions concerning the input range, please contact a TI field representative prior to connecting the input power.

Applying loads outside of the specified output range may result in unintended operation and/or possible permanent damage to the EVM. Please consult the EVM User's Guide prior to connecting any load to the EVM output. If there is uncertainty as to the load specification, please contact a TI field representative.

During normal operation, some circuit components may have case temperatures greater than 40° C. The EVM is designed to operate properly with certain components above 80° C as long as the input and output ranges are maintained. These components include but are not limited to linear regulators, switching transistors, pass transistors, and current sense resistors. These types of devices can be identified using the EVM schematic located in the EVM User's Guide. When placing measurement probes near these devices during operation, please be aware that these devices may be very warm to the touch.

Mailing Address: Texas Instruments, Post Office Box 655303, Dallas, Texas 75265  
Copyright © 2012, Texas Instruments Incorporated

## IMPORTANT NOTICE

Texas Instruments Incorporated and its subsidiaries (TI) reserve the right to make corrections, modifications, enhancements, improvements, and other changes to its products and services at any time and to discontinue any product or service without notice. Customers should obtain the latest relevant information before placing orders and should verify that such information is current and complete. All products are sold subject to TI's terms and conditions of sale supplied at the time of order acknowledgment.

TI warrants performance of its hardware products to the specifications applicable at the time of sale in accordance with TI's standard warranty. Testing and other quality control techniques are used to the extent TI deems necessary to support this warranty. Except where mandated by government requirements, testing of all parameters of each product is not necessarily performed.

TI assumes no liability for applications assistance or customer product design. Customers are responsible for their products and applications using TI components. To minimize the risks associated with customer products and applications, customers should provide adequate design and operating safeguards.

TI does not warrant or represent that any license, either express or implied, is granted under any TI patent right, copyright, mask work right, or other TI intellectual property right relating to any combination, machine, or process in which TI products or services are used. Information published by TI regarding third-party products or services does not constitute a license from TI to use such products or services or a warranty or endorsement thereof. Use of such information may require a license from a third party under the patents or other intellectual property of the third party, or a license from TI under the patents or other intellectual property of TI.

Reproduction of TI information in TI data books or data sheets is permissible only if reproduction is without alteration and is accompanied by all associated warranties, conditions, limitations, and notices. Reproduction of this information with alteration is an unfair and deceptive business practice. TI is not responsible or liable for such altered documentation. Information of third parties may be subject to additional restrictions.

Resale of TI products or services with statements different from or beyond the parameters stated by TI for that product or service voids all express and any implied warranties for the associated TI product or service and is an unfair and deceptive business practice. TI is not responsible or liable for any such statements.

TI products are not authorized for use in safety-critical applications (such as life support) where a failure of the TI product would reasonably be expected to cause severe personal injury or death, unless officers of the parties have executed an agreement specifically governing such use. Buyers represent that they have all necessary expertise in the safety and regulatory ramifications of their applications, and acknowledge and agree that they are solely responsible for all legal, regulatory and safety-related requirements concerning their products and any use of TI products in such safety-critical applications, notwithstanding any applications-related information or support that may be provided by TI. Further, Buyers must fully indemnify TI and its representatives against any damages arising out of the use of TI products in such safety-critical applications.

TI products are neither designed nor intended for use in military/aerospace applications or environments unless the TI products are specifically designated by TI as military-grade or "enhanced plastic." Only products designated by TI as military-grade meet military specifications. Buyers acknowledge and agree that any such use of TI products which TI has not designated as military-grade is solely at the Buyer's risk, and that they are solely responsible for compliance with all legal and regulatory requirements in connection with such use.

TI products are neither designed nor intended for use in automotive applications or environments unless the specific TI products are designated by TI as compliant with ISO/TS 16949 requirements. Buyers acknowledge and agree that, if they use any non-designated products in automotive applications, TI will not be responsible for any failure to meet such requirements.

Following are URLs where you can obtain information on other Texas Instruments products and application solutions:

### Products

Audio	<a href="http://www.ti.com/audio">www.ti.com/audio</a>
Amplifiers	<a href="http://amplifier.ti.com">amplifier.ti.com</a>
Data Converters	<a href="http://dataconverter.ti.com">dataconverter.ti.com</a>
DLP® Products	<a href="http://www.dlp.com">www.dlp.com</a>
DSP	<a href="http://dsp.ti.com">dsp.ti.com</a>
Clocks and Timers	<a href="http://www.ti.com/clocks">www.ti.com/clocks</a>
Interface	<a href="http://interface.ti.com">interface.ti.com</a>
Logic	<a href="http://logic.ti.com">logic.ti.com</a>
Power Mgmt	<a href="http://power.ti.com">power.ti.com</a>
Microcontrollers	<a href="http://microcontroller.ti.com">microcontroller.ti.com</a>
RFID	<a href="http://www.ti-rfid.com">www.ti-rfid.com</a>
OMAP Mobile Processors	<a href="http://www.ti.com/omap">www.ti.com/omap</a>
Wireless Connectivity	<a href="http://www.ti.com/wirelessconnectivity">www.ti.com/wirelessconnectivity</a>

### Applications

Automotive and Transportation	<a href="http://www.ti.com/automotive">www.ti.com/automotive</a>
Communications and Telecom	<a href="http://www.ti.com/communications">www.ti.com/communications</a>
Computers and Peripherals	<a href="http://www.ti.com/computers">www.ti.com/computers</a>
Consumer Electronics	<a href="http://www.ti.com/consumer-apps">www.ti.com/consumer-apps</a>
Energy and Lighting	<a href="http://www.ti.com/energy">www.ti.com/energy</a>
Industrial	<a href="http://www.ti.com/industrial">www.ti.com/industrial</a>
Medical	<a href="http://www.ti.com/medical">www.ti.com/medical</a>
Security	<a href="http://www.ti.com/security">www.ti.com/security</a>
Space, Avionics and Defense	<a href="http://www.ti.com/space-avionics-defense">www.ti.com/space-avionics-defense</a>
Video and Imaging	<a href="http://www.ti.com/video">www.ti.com/video</a>

TI E2E Community Home Page

[e2e.ti.com](http://e2e.ti.com)

Mailing Address: Texas Instruments, Post Office Box 655303, Dallas, Texas 75265  
Copyright © 2012, Texas Instruments Incorporated

Компания «Океан Электроники» предлагает заключение долгосрочных отношений при поставках импортных электронных компонентов на взаимовыгодных условиях!

Наши преимущества:

- Поставка оригинальных импортных электронных компонентов напрямую с производств Америки, Европы и Азии, а так же с крупнейших складов мира;
- Широкая линейка поставок активных и пассивных импортных электронных компонентов (более 30 млн. наименований);
- Поставка сложных, дефицитных, либо снятых с производства позиций;
- Оперативные сроки поставки под заказ (от 5 рабочих дней);
- Экспресс доставка в любую точку России;
- Помощь Конструкторского Отдела и консультации квалифицированных инженеров;
- Техническая поддержка проекта, помощь в подборе аналогов, поставка прототипов;
- Поставка электронных компонентов под контролем ВП;
- Система менеджмента качества сертифицирована по Международному стандарту ISO 9001;
- При необходимости вся продукция военного и аэрокосмического назначения проходит испытания и сертификацию в лаборатории (по согласованию с заказчиком);
- Поставка специализированных компонентов военного и аэрокосмического уровня качества (Xilinx, Altera, Analog Devices, Intersil, Interpoint, Microsemi, Actel, Aeroflex, Peregrine, VPT, Syfer, Eurofarad, Texas Instruments, MS Kennedy, Miteq, Cobham, E2V, MA-COM, Hittite, Mini-Circuits, General Dynamics и др.);

Компания «Океан Электроники» является официальным дистрибьютором и эксклюзивным представителем в России одного из крупнейших производителей разъемов военного и аэрокосмического назначения «JONHON», а так же официальным дистрибьютором и эксклюзивным представителем в России производителя высокотехнологичных и надежных решений для передачи СВЧ сигналов «FORSTAR».



## JONHON

«JONHON» (основан в 1970 г.)

Разъемы специального, военного и аэрокосмического назначения:

(Применяются в военной, авиационной, аэрокосмической, морской, железнодорожной, горно- и нефтедобывающей отраслях промышленности)

«FORSTAR» (основан в 1998 г.)

ВЧ соединители, коаксиальные кабели, кабельные сборки и микроволновые компоненты:

(Применяются в телекоммуникациях гражданского и специального назначения, в средствах связи, РЛС, а так же военной, авиационной и аэрокосмической отраслях промышленности).



Телефон: 8 (812) 309-75-97 (многоканальный)

Факс: 8 (812) 320-03-32

Электронная почта: [ocean@oceanchips.ru](mailto:ocean@oceanchips.ru)

Web: <http://oceanchips.ru/>

Адрес: 198099, г. Санкт-Петербург, ул. Калинина, д. 2, корп. 4, лит. А