

---

### **PWM/ VFM, Dual-channel Step-up/ Inverting DC/DC Converter with Synchronous Rectifier for LCD**

---

NO.EA-325-160421

#### **OUTLINE**

The R1287x is a CMOS-based PWM/ VFM dual-channel step-up/ inverting DC/DC converter with synchronous rectifier for LCD. The step-up DC/DC converter (CH1) generates a 4.5 V to 5.8 V boosted output voltage and the inverting DC/DC converter (CH2) generates a -4.5 V to -6.0 V inverting output voltage.

Internally, the R1287x consists of an oscillator circuit, PWM control circuits, a reference voltage unit, error amplifiers, soft-start circuits, a  $L_x$  peak current limit circuit, short protection circuits, thermal shutdown circuit, an under voltage lockout circuit (UVLO), a NMOS transistor driver and a synchronous PMOS transistor driver for CH1, and a PMOS transistor driver and a synchronous NMOS transistor driver for CH2.

The R1287x is employing synchronous rectification for improving the efficiency of rectification by replacing diodes with built-in switching transistors. Using synchronous rectification not only increases circuit performance but also allows a design to reduce parts count.

The R1287x provides the normal PWM control or the PWM/VFM auto switching control. The PWM normal control switches at fixed frequency rate in low output current in order to reduce noise. Likewise, the PWM/VFM auto switching control automatically switches from PWM mode to VFM mode in low output current in order to achieve high efficiency. RICOH's unique control method can suppress a ripple voltage in the VFM mode, thus the R1287x can achieve both low ripple voltage at light load and high efficiency.

Both CH1 and CH2 can independently control the ON/ OFF control and freely set the starting sequence and shutdown sequence.

Both CH1 and CH2 own an auto-discharge function which actively discharges the output voltage to ground when the device is placed in shutdown mode.

The R1287x is offered in a 12-pin WLCSP-12-P1 package and a 12-pin DFN3030-12 package.

---

## R1287x

---

NO.EA-325-160421

### FEATURES

- Operating Voltage Range ..... 2.5 V to 5.5 V

#### [Step-up DC/DC Converter (CH1)]

- Selectable Step-up Output Voltage ( $V_{OUTP}$ ) ..... R1287xxxxy: 4.5 V to 5.8 V (0.1 V Step)
- Step-up Output Voltage (Externally adjustable) ..... R1287x001y: 4.5 V to 5.8 V
- Maximum Output Current (Dependent on inductance) ..... R1287xxxxB/D/F/H: 200 mA,  
R1287xxxxC/G: 100 mA

#### [Inverting DC/DC Converter (CH2)]

- Selectable Inverting Output Voltage ( $V_{OUTN}$ ) ..... R1287xxxxy: -4.5 V to -5.8 V (0.1 V Step)
- Inverting Output Voltage (externally adjustable) ..... R1287x001y: -4.5 V to -6.0 V
- Maximum Output Current (dependent on inductance) ..... R1287xxxxB/D/F/H: 200 mA,  
R1287xxxxC/G: 100 mA

#### [Controller]

- ON/ OFF Control: Operates CH1/ CH2 separately by the EN1/ EN2 pin.
- Auto-discharge Function: Discharges the output voltage to GND within a short time in shutdown mode.
- Latch-type Short Circuit Protection: Short-circuiting of either one of CH1 or CH2 activates this circuit.
  
- Maximum Duty Cycle
  
- $L_x$  Peak Current Limit Function
- Undervoltage Lockout (UVLO) Threshold ..... Typ. 2.25 V
- Thermal Shutdown Temperature ..... Typ. 150°C
- Oscillator Frequency ..... R1287xxxxB/D/F/H: 1 MHz,  
R1287xxxxC/G: 300 kHz
- Package ..... WLCSP-12-P1, DFN3030-12

### APPLICATIONS

- Power source for hand-held equipment
- Power source for LCD

**BLOCK DIAGRAMS**

R1287xxxxy Block Diagram (Fixed Output Voltage Type)

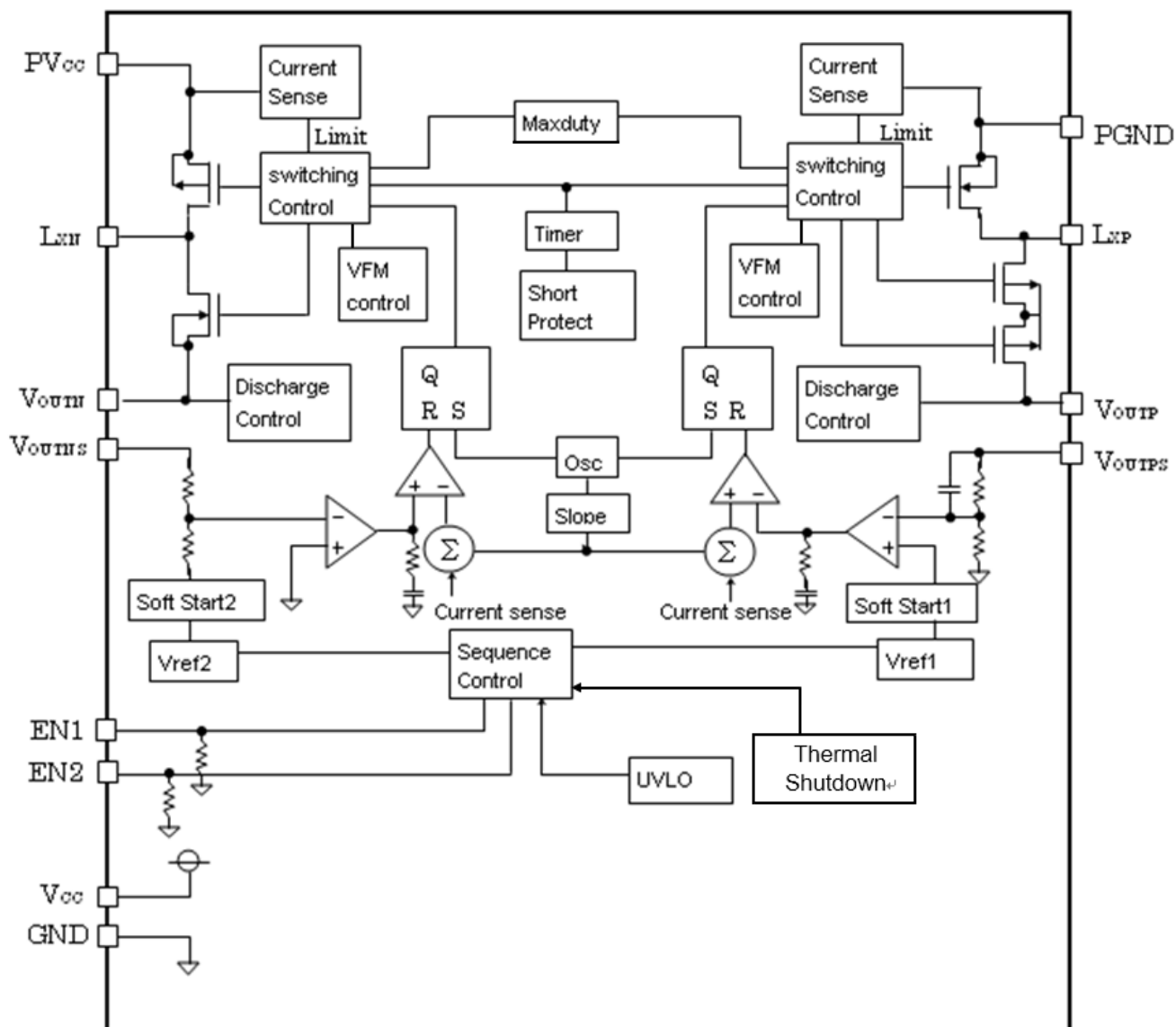

---

**R1287x**

---

NO.EA-325-160421

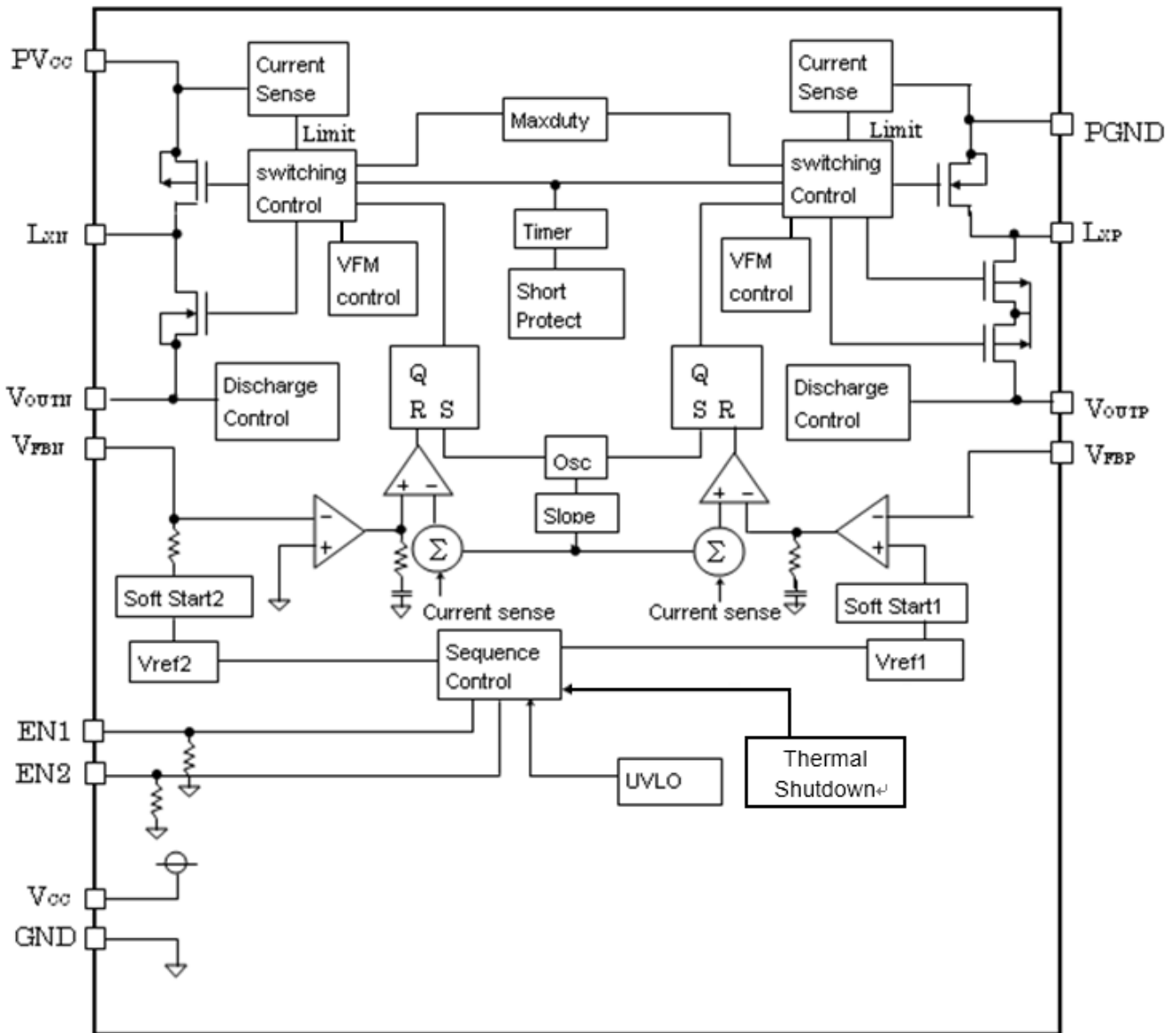
**R1287x001y Block Diagram (Adjustable Output Voltage Type)**

## SELECTION GUIDE

The output voltage types are user-selectable options that can be selected from either fixed output voltage type or adjustable output voltage type. With the fixed output voltage type, the combination of a CH1 output voltage and a CH2 output voltage can be selected. The combination of an oscillator frequency, a power controlling method, and a discharge current can also be selected.

### Selection Guide

Product Name	Package	Quantity per Reel	Pb Free	Halogen Free
R1287Zxxxxy-E2-F	WLCSP-12-P1	4,000 pcs	Yes	Yes
R1287Lxxxxy-TR	DFN3030-12	3,000 pcs	Yes	Yes

xxx: Specify the set output voltage ( $V_{SET}$ ).

001: Adjustable Output Voltage Type, The output voltage is adjustable using external resistors.

002 to 009<sup>\*2</sup>: Fixed Output Voltage Type

CH1 Output Voltage ( $V_{OUTP}$ ): selectable from +4.5 V to +5.8 V by 0.1 V step<sup>\*1</sup>

CH2 Output Voltage ( $V_{OUTN}$ ): selectable from -4.5 V to -5.8 V by 0.1 V step<sup>\*1</sup>

Notes: Refer to *Output Voltage for All Combinations of  $V_{OUTP}$  and  $V_{OUTN}$* .

y: Specify the oscillator frequency, the power controlling method, and the discharge current.

(B) 1 MHz, PWM/ VFM Auto Switching Control, discharge current 0.06 mA

(C) 300 kHz, Normal PWM Control, discharge current 0.06 mA

(D) 1 MHz, Normal PWM Control, discharge current 0.06 mA

(F) 1 MHz, PWM/ VFM Auto Switching Control, discharge current 0.4 mA<sup>\*3</sup>

(G) 300 kHz, Normal PWM Control, discharge current 0.4 mA<sup>\*3</sup>

(H) 1 MHz, Normal PWM Control, discharge current 0.4 mA<sup>\*3</sup>

<sup>\*1</sup> 0.05 V step is also available as a custom code.

<sup>\*2</sup> 009 is only available for WLCSP-12-P1 package.

<sup>\*3</sup> F/G/H versions are only available for WLCSP-12-P1 package.

### Output Voltage for All Combinations of $V_{OUTP}$ and $V_{OUTN}$

$V_{SET}$ Code No. (xxx)	CH1 Output Voltage ( $V_{OUTP}$ )	CH2 Output Voltage ( $V_{OUTN}$ )
001	Adjustable using external resistors	Adjustable using external resistors
002	5.0	-5.0
003	5.4	-5.4
004	5.75	-5.75
005	5.6	-5.6
006	4.5	-4.5
007	5.8	-5.8
008	5.5	-5.5
009	5.1	-5.1

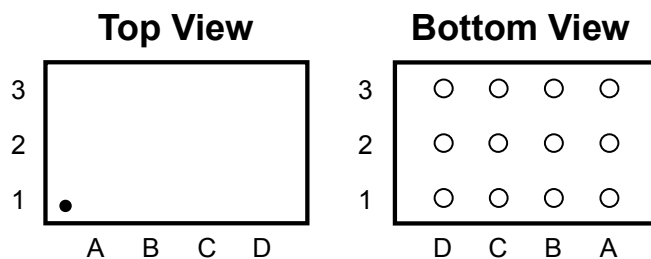
**PIN DESCRIPTIONS****WLCSP-12-P1 Pin Configurations****WLCSP-12-P1 Pin Description**

Pin No.	Symbol	Description
A1	$V_{OUTN}$	CH2 Output Voltage Pin
A2	PGND	Power Ground Pin
A3	$L_{XP}$	CH1 Switching Output Pin
B1	$L_{XN}$	CH2 Switching Output Pin
B2	GND	Analog Ground Pin
B3	$V_{OUTP}$	CH1 Output Voltage Pin
C1	$PV_{CC}$	Power Input Voltage Pin
C2	$V_{CC}$	Analog Power Input Voltage Pin
C3	$V_{OUTPS}$	CH1 Feedback Voltage Pin
	$V_{FBP}$	
D1	$V_{OUTNS}$	CH2 Feedback Voltage Pin
	$V_{FBN}$	
D2	EN2	CH2 Enable Control Pin
D3	EN1	CH1 Enable Control Pin

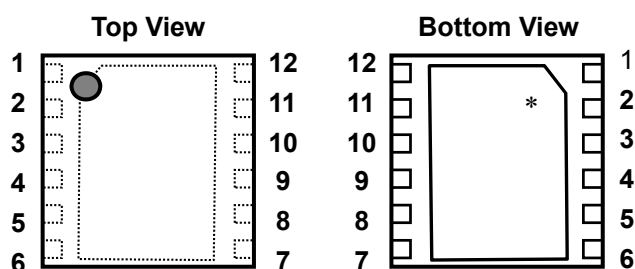

DFN3030-12 Pin Configuration

## DFN3030-12 Pin Description

Pin No.	Symbol		Description
1	EN2		CH2 Enable Control Pin
2	$V_{OUTNS}$	R1287Lxxxxy	CH2 Feedback Voltage Pin
	$V_{FBN}$	R1287L001y	
3	$V_{CC}$		Analog Power Input Voltage Pin
4	$PV_{CC}$		Power Input Voltage Pin
5	$L_{XN}$		CH2 Switching Output Pin
6	$V_{OUTN}$		CH2 Output Voltage Pin
7	PGND		Power Ground Pin
8	$L_{XP}$		CH1 Switching Output Pin
9	$V_{OUTP}$		CH1 Output Voltage Pin
10	$V_{OUTPS}$	R1287Lxxxxy	CH1 Feedback Voltage Pin
	$V_{FBP}$	R1287L001y	
11	GND		Analog Ground Pin
12	EN1		CH1 Enable Control Pin

\* The tab on the bottom of the package enhances thermal performance and is electrically connected to GND (substrate level). It is recommended that the tab be connected to the ground plane on the board, or otherwise be left floating.

## R1287x

NO.EA-325-160421

### ABSOLUTE MAXIMUM RATINGS

#### Absolute Maximum Ratings

(GND = PGND = 0 V)

Symbol	Item		Rating	Unit
V <sub>CC</sub>	V <sub>CC</sub> / PV <sub>CC</sub> Pin Voltage		-0.3 to 6.0	V
V <sub>EN</sub>	EN1/ EN2 Pin Voltage		-0.3 to 6.0	V
V <sub>LXP</sub>	L <sub>XP</sub> Pin Voltage		-0.3 to 6.5	V
V <sub>OUTP</sub>	V <sub>OUTP</sub> Pin Voltage		-0.3 to 6.5	V
V <sub>LXN</sub>	L <sub>XN</sub> Pin Voltage		V <sub>CC</sub> - 14 to V <sub>CC</sub> + 0.3	V
V <sub>OUTN</sub>	V <sub>OUTN</sub> Pin Voltage		V <sub>CC</sub> - 14 to 0.3	V
V <sub>OUTPS</sub>	V <sub>OUTPS</sub> Pin Voltage	R1287xxxxxy	-0.3 ~ 6.5	V
V <sub>OUTNS</sub>	V <sub>OUTNS</sub> Pin Voltage	R1287xxxxxy	V <sub>CC</sub> - 14 ~ V <sub>CC</sub> + 0.3	V
V <sub>FBP</sub>	V <sub>FBP</sub> Pin Voltage	R1287x001y	-0.3 to V <sub>CC</sub> + 0.3	V
V <sub>FBN</sub>	V <sub>FBN</sub> Pin Voltage	R1287x001y	-0.3 to V <sub>CC</sub> + 0.3	V
P <sub>D</sub>	Power Dissipation (WLCSP-12-P1)* <sup>1</sup>	Standard Test Land Pattern	1000	mW
	Power Dissipation (DFN3030-12)* <sup>1</sup>	Standard Test Land Pattern	1000	
		JEDEC STD. 51-7 Test Land Pattern	1950	
T <sub>a</sub>	Operating Temperature Range		-40 to 85	°C
T <sub>stg</sub>	Storage Temperature Range		-55 to 125	°C

\*<sup>1</sup> Refer to *PACKAGE INFORMATION* for detailed information.

#### ABSOLUTE MAXIMUM RATINGS

Electronic and mechanical stress momentarily exceeded absolute maximum ratings may cause the permanent damages and may degrade the life time and safety for both device and system using the device in the field. The functional operation at or over these absolute maximum ratings is not assured.

#### RECOMMENDED OPERATING CONDITIONS (ELECTRICAL CHARACTERISTICS)

All of electronic equipment should be designed that the mounted semiconductor devices operate within the recommended operating conditions. The semiconductor devices cannot operate normally over the recommended operating conditions, even if when they are used over such conditions by momentary electronic noise or surge. And the semiconductor devices may receive serious damage when they continue to operate over the recommended operating conditions.



## ELECTRICAL CHARACTERISTICS

The specifications surrounded by  are guaranteed by design engineering at  $-40^{\circ}\text{C} \leq T_a \leq 85^{\circ}\text{C}$ .

### R1287x Electrical Characteristics

(Ta = 25°C)

Symbol	Item	Conditions	Min.	Typ.	Max.	Unit
V <sub>CC</sub>	Operating Input Voltage	R1287xxxxy	2.5		5.5	V
I <sub>CC</sub>	V <sub>CC</sub> Consumption Current (at no switching)	V <sub>CC</sub> = 5.5 V, R1287xxxxy		470		μA
I <sub>standby</sub>	Standby Current	V <sub>CC</sub> = V <sub>LXP</sub> = 5.5 V, V <sub>EN</sub> = V <sub>LXN</sub> = 0 V, R1287xxxxy		0.1	5	μA
V <sub>UVLO1</sub>	UVLO Detector Threshold	Falling, R1287xxxxy	2.15	2.25		V
V <sub>UVLO2</sub>	UVLO Released Voltage	Rising, R1287xxxxy		V <sub>UVLO1</sub> +0.10	2.48	V
V <sub>EN1H</sub>	EN1 "H" Input Voltage	V <sub>CC</sub> = 3.7 V, R1287xxxxy	1.2			V
V <sub>EN1L</sub>	EN1 "L" Input Voltage	V <sub>CC</sub> = 3.7 V, R1287xxxxy			0.4	V
R <sub>EN1</sub>	EN1 Pull-down Resistance	V <sub>CC</sub> = 3.7 V, R1287xxxxy		1000		kΩ
V <sub>EN2H</sub>	EN2 "H" Input Voltage	V <sub>CC</sub> = 3.7 V, R1287xxxxy	1.2			V
V <sub>EN2L</sub>	EN2 "L" Input Voltage	V <sub>CC</sub> = 3.7 V, R1287xxxxy			0.4	V
R <sub>EN2</sub>	EN2 Pull-down Resistance	V <sub>CC</sub> = 3.7 V, R1287xxxxy		1000		kΩ
t <sub>prot</sub>	Protection Delay Time	V <sub>CC</sub> = 3.7 V, R1287xxxxy	21	30	39	ms
T <sub>TSD</sub>	Thermal Shutdown Temperature	V <sub>CC</sub> = 3.7 V, R1287xxxxy		150		°C
T <sub>TSR</sub>	Thermal Shutdown Released Temperature	V <sub>CC</sub> = 3.7 V, R1287xxxxy		125		°C

### STEP-UP DC/DC CONVERTER (CH1)

$\Delta V_{\text{OUTP}} / \Delta I_{\text{OUT}}$	V <sub>OUTP</sub> Load Regulation	3.2 V ≤ V <sub>CC</sub> ≤ 4.2 V, 10 mA ≤ I <sub>OUT</sub> ≤ 100 mA, R1287xxxxB/F			±0.3		%
		3.2 V ≤ V <sub>CC</sub> ≤ 4.2 V, 10 mA ≤ I <sub>OUT</sub> ≤ 100 mA, R1287xxxxC/D/G/H			±0.2		%
f <sub>oscp</sub>	CH1 PWM Oscillator Frequency	V <sub>CC</sub> = 3.7 V	R1287xxxxB/F	700	900	1100	kHz
			R1287xxxxC/G	240	300	360	kHz
			R1287xxxxD/H	800	1000	1200	kHz
Maxduty1	CH1 Maximum Duty Cycle	V <sub>CC</sub> = 3.7 V	R1287xxxxB/D/F/H		90		%
			R1287xxxxC/G		97		%
I <sub>VOUTP</sub>	V <sub>OUTP</sub> Discharge Current	V <sub>CC</sub> = 3.7 V, V <sub>OUTP</sub> = 0.1 V	R1287xxxxB/C/D		0.06		mA
			R1287xxxxF/G/H		0.4		mA
t <sub>ssp</sub>	CH1 Soft-start Time	V <sub>CC</sub> = 3.7 V, EN1 = "H" to V <sub>OUTP</sub> = V <sub>SET</sub>	R1287xxxxB/F	1.91		5.54	ms
			R1287xxxxC/G		4.5		ms
			R1287xxxxD/H		4.5		ms

---

**R1287x**

---

NO.EA-325-160421

**ELECTRICAL CHARACTERISTICS (continued)**

The specifications surrounded by   are guaranteed by design engineering at  $-40^{\circ}\text{C} \leq T_a \leq 85^{\circ}\text{C}$ .

**R1287x Electrical Characteristics**

(Ta = 25°C)

Symbol	Item	Conditions	Min.	Typ.	Max.	Unit
trp	CH1 Rising Time	$V_{CC} = 3.7\text{ V}$ , $V_{OUTP} = V_{SET} \times 10\% \text{ to } 90\%$ , R1287xxxxB/F	<span style="border: 1px solid black; padding: 0 2px;">1.53</span>		<span style="border: 1px solid black; padding: 0 2px;">4.99</span>	ms
RLXP	Nch Tr. ON Resistance	$V_{CC} = 3.7\text{ V}$ , R1287xxxxy		400		mΩ
RSYNCP	Pch Tr. ON Resistance	$V_{CC} = 3.7\text{ V}$ , R1287xxxxy		700		mΩ
ILIMLXP	Nch Tr. Current Limit	$V_{CC} = 3.7\text{ V}$ , R1287xxxxy		1.1		A
VUVP	V <sub>OUTP</sub> Low Voltage Detector Threshold	$V_{CC} = 3.7\text{ V}$ , R1287xxxxy		2.7		V

All test items listed under *ELECTRICAL CHARACTERISTICS* are done under the pulse load condition ( $T_j \approx T_a = 25^{\circ}\text{C}$ ) except V<sub>OUTP</sub> Load Regulation, CH1 Rising Time, Nch Tr. ON Resistance and Pch Tr. ON Resistance.

## ELECTRICAL CHARACTERISTICS (continued)

The specifications surrounded by   are guaranteed by design engineering at  $-40^{\circ}\text{C} \leq T_a \leq 85^{\circ}\text{C}$ .

### R1287x Electrical Characteristics

(Ta = 25°C)

Symbol	Item	Conditions	Min.	Typ.	Max.	Unit
<b>[R1287xxxxB, R1287xxxxC, R1287xxxxD, R1287xxxxF, R1287xxxxG, R1287xxxxH]</b>						
V <sub>OUTP</sub>	V <sub>OUTP</sub> Voltage	V <sub>CC</sub> = 3.7 V	×0.991	V <sub>SET</sub>	×1.009	V
V <sub>OUTP</sub> /ΔTa	V <sub>OUTP</sub> Voltage Temperature Coefficient	V <sub>CC</sub> = 3.7 V, $-40^{\circ}\text{C} \leq T_a \leq 85^{\circ}\text{C}$		±50		ppm/°C
<b>[R1287x001B, R1287x001C, R1287x001D, R1287x001F, R1287x001G, R1287x001H]</b>						
V <sub>FBP</sub>	V <sub>FBP</sub> Voltage	V <sub>CC</sub> = 3.7 V	0.985	1.000	1.015	V
I <sub>FBP</sub>	V <sub>FBP</sub> Input Current	V <sub>CC</sub> = 5.5 V, V <sub>FBP</sub> = 0 V or 5.5 V	-0.1		0.1	μA
ΔV <sub>FBP</sub> /ΔTa	V <sub>FBP</sub> Voltage Temperature Coefficient	V <sub>CC</sub> = 3.7 V, $-40^{\circ}\text{C} \leq T_a \leq 85^{\circ}\text{C}$		±50		ppm/°C

### INVERTING DC/DC CONVERTER (CH2)

ΔV <sub>OUTN</sub> /ΔI <sub>OUT</sub>	V <sub>OUTN</sub> Load Regulation	3.2 V ≤ V <sub>CC</sub> ≤ 4.2 V, 10 mA ≤ I <sub>OUT</sub> ≤ 100 mA, R1287xxxxB/F		±0.4		%	
		3.2V ≤ V <sub>CC</sub> ≤ 4.2 V, 10 mA ≤ I <sub>OUT</sub> ≤ 100 mA, R1287xxxxC/D/G/H		±0.2		%	
foscN	CH2 PWM Oscillator Frequency	V <sub>CC</sub> = 3.7 V	R1287xxxxB/F	900	1100	1300	kHz
			R1287xxxxC/G	240	300	360	kHz
			R1287xxxxD/H	800	1000	1200	kHz
Maxduty2	CH2 Maximum Duty Cycle	V <sub>CC</sub> = 3.7 V	R1287xxxxB/D/F/H		90		%
			R1287xxxxC/G		97		%
I <sub>VOUTN</sub>	V <sub>OUTN</sub> Discharge Current	V <sub>CC</sub> = 3.7 V, V <sub>OUTN</sub> = -0.1	R1287xxxxB/C/D		0.2		mA
			R1287xxxxF/G/H		0.4		mA
tssN	CH2 Soft-start Time	V <sub>CC</sub> = 3.7 V, EN2 = "H" to V <sub>OUTN</sub> = V <sub>SET</sub> ,	R1287xxxxB/F	0.73		4.11	ms
			R1287xxxxC/G		2.6		ms
			R1287xxxxD/H		2.6		ms
trN	CH2 Rising Time	V <sub>CC</sub> = 3.7 V, V <sub>OUTN</sub> = V <sub>SET</sub> × 10% to 90%, R1287xxxxB/F	<span style="border: 1px solid black; padding: 0 2px;">0.58</span>		<span style="border: 1px solid black; padding: 0 2px;">3.29</span>	ms	
R <sub>LXN</sub>	Pch Tr. ON Resistance	V <sub>CC</sub> = 3.7 V, R1287xxxxy		400		mΩ	
R <sub>SYNCH</sub>	Nch Tr. ON Resistance	V <sub>CC</sub> = 3.7 V, R1287xxxxy		600		mΩ	
I <sub>LIMLXN</sub>	Pch Tr. Current Limit	V <sub>CC</sub> = 3.7 V, R1287xxxxy		1.5		A	

### [R1287xxxxB, R1287xxxxC, R1287xxxxD, R1287xxxxF, R1287xxxxG, R1287xxxxH]

V <sub>OUTN</sub>	V <sub>OUTN</sub> Voltage	V <sub>CC</sub> = 3.7 V	×0.990	V <sub>SET</sub>	×1.01	V
ΔV <sub>OUTN</sub> /ΔTa	V <sub>OUTN</sub> Voltage Temperature Coefficient	V <sub>CC</sub> = 3.7 V, $-40^{\circ}\text{C} \leq T_a \leq 85^{\circ}\text{C}$		±50		ppm/°C

---

**R1287x**

---

NO.EA-325-160421

**ELECTRICAL CHARACTERISTICS (continued)**The specifications surrounded by   are guaranteed by design engineering at  $-40^{\circ}\text{C} \leq T_a \leq 85^{\circ}\text{C}$ .**R1287x Electrical Characteristics**

(Ta = 25°C)

Symbol	Item	Conditions	Min.	Typ.	Max.	Unit
<b>[R1287x001B, R1287x001C, R1287x001D, R1287x001F, R1287x001G, R1287x001H]</b>						
V <sub>FBN0</sub>	V <sub>FBN</sub> Voltage	V <sub>CC</sub> = 3.7 V	-30	0	30	mV
I <sub>FBN</sub>	V <sub>FBN</sub> Input Current	V <sub>CC</sub> = 3.7 V, V <sub>FBN</sub> = V <sub>FBN0</sub> X 1.2	6.541	6.667	6.794	μA
$\frac{\Delta I_{FBN}}{\Delta T_a}$	I <sub>FBN</sub> Current Temperature Coefficient	V <sub>CC</sub> = 3.7 V, $-40^{\circ}\text{C} \leq T_a \leq 85^{\circ}\text{C}$		±150		ppm /°C

All test items listed under *ELECTRICAL CHARACTERISTICS* are done under the pulse load condition ( $T_j \approx T_a = 25^{\circ}\text{C}$ ) except V<sub>OUTP</sub> Voltage Temperature Coefficient, V<sub>FBP</sub> Voltage Temperature Coefficient, V<sub>OUTN</sub> Load Regulation, CH2 Rising Time, Pch Tr. ON Resistance, Nch Tr. ON Resistance, V<sub>OUTN</sub> Voltage Temperature Coefficient and I<sub>FBN</sub> Current Temperature Coefficient.

## ELECTRICAL CHARACTERISTICS (continued)

### CH1 Electrical Characteristics by Different Output Voltage

Product Name	$\Delta V_{OUTP}/\Delta I_{OUT}$ [%]	fosc [kHz]			Maxduty1 [%]	V <sub>OUT</sub> [V]		
	Typ.	Min.	Typ.	Max.	Typ.	Min.	Typ.	Max.
R1287x001B/F	±0.3	700	900	1100	90	-	-	-
R1287x001C/G	±0.2	240	300	360	97			
R1287x001D/H		800	1000	1200	90			
R1287x002B/F	±0.3	700	900	1100	90	4.955	5.0	5.045
R1287x002C/G	±0.2	240	300	360	97			
R1287x002D/H		800	1000	1200	90			
R1287x003B/F	±0.3	700	900	1100	90	5.351	5.4	5.449
R1287x003C/G	±0.2	240	300	360	97			
R1287x003D/H		800	1000	1200	90			
R1287x004B/F	±0.3	700	900	1100	90	5.698	5.75	5.802
R1287x004C/G	±0.2	240	300	360	97			
R1287x004D/H		800	1000	1200	90			
R1287x005B/F	±0.3	700	900	1100	90	5.550	5.6	5.650
R1287x005C/G	±0.2	240	300	360	97			
R1287x005D/H		800	1000	1200	90			
R1287x006B/F	±0.3	700	900	1100	90	4.460	4.5	4.541
R1287x006C/G	±0.2	240	300	360	97			
R1287x006D/H		800	1000	1200	90			
R1287x007B/F	±0.3	700	900	1100	90	5.748	5.8	5.852
R1287x007C/G	±0.2	240	300	360	97			
R1287x007D/H		800	1000	1200	90			
R1287x008B/F	±0.3	700	900	1100	90	5.451	5.5	5.550
R1287x008C/G	±0.2	240	300	360	97			
R1287x008D/H		800	1000	1200	90			
R1287x009B/F	±0.3	700	900	1100	90	5.054	5.1	5.146
R1287x009C/G	±0.2	240	300	360	97			
R1287x009D/H		800	1000	1200	90			

**R1287x**

NO.EA-325-160421

**ELECTRICAL CHARACTERISTICS (continued)****CH2 Electrical Characteristics by Different Output Voltage**

Product Name	$\Delta V_{OUTN}/\Delta I_{OUT}$	foscN			Maxduty2	V <sub>OUT</sub>		
	[%]	[kHz]			[%]	[V]		
	Typ.	Min.	Typ.	Max.	Typ.	Min.	Typ.	Max.
R1287x001B/F	±0.4	900	1100	1200	90	-	-	-
R1287x001C/G	±0.2	240	300	360	97			
R1287x001D/H		800	1000	1200	90			
R1287x002B/F	±0.4	900	1100	1200	90	-4.950	-5.0	-5.050
R1287x002C/G	±0.2	240	300	360	97			
R1287x002D/H		800	1000	1200	90			
R1287x003B/F	±0.4	900	1100	1200	90	-5.346	-5.4	-5.454
R1287x003C/G	±0.2	240	300	360	97			
R1287x003D/H		800	1000	1200	90			
R1287x004B/F	±0.4	900	1100	1200	90	-5.693	-5.75	-5.808
R1287x004C/G	±0.2	240	300	360	97			
R1287x004D/H		800	1000	1200	90			
R1287x005B/F	±0.4	900	1100	1200	90	-5.544	-5.6	-5.656
R1287x005C/G	±0.2	240	300	360	97			
R1287x005D/H		800	1000	1200	90			
R1287x006B/F	±0.4	900	1100	1200	90	-4.455	-4.5	-4.545
R1287x006C/G	±0.2	240	300	360	97			
R1287x006D/H		800	1000	1200	90			
R1287x007B/F	±0.4	900	1100	1200	90	-5.742	-5.8	-5.858
R1287x007C/G	±0.2	240	300	360	97			
R1287x007D/H		800	1000	1200	90			
R1287x008B/F	±0.4	900	1100	1200	90	-5.445	-5.5	-5.555
R1287x008C/G	±0.2	240	300	360	97			
R1287x008D/H		800	1000	1200	90			
R1287x009B/F	±0.4	900	1100	1200	90	-5.049	-5.1	-5.151
R1287x009C/G	±0.2	240	300	360	97			
R1287x009D/H		800	1000	1200	90			

## TYPICAL APPLICATION

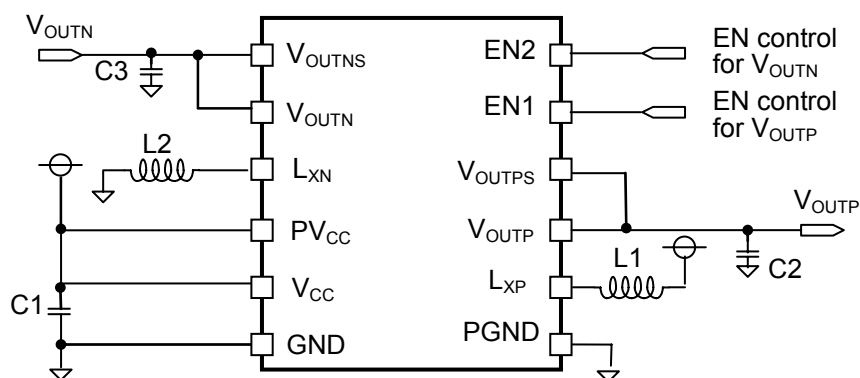

R1287xxxxy Typical Application (Fixed Output Voltage Type)

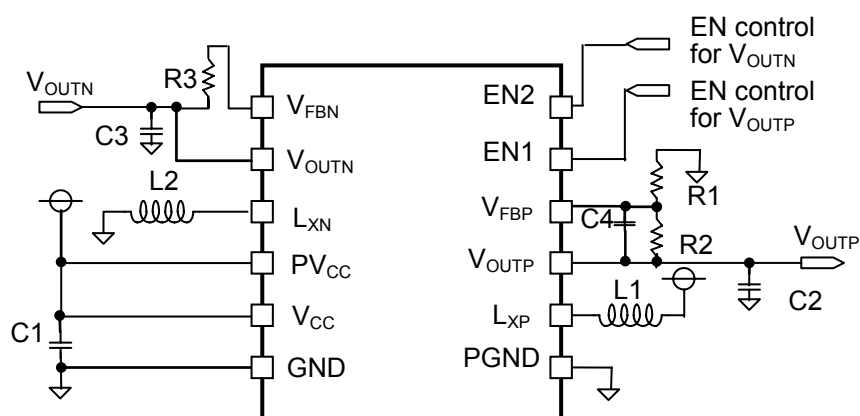

R1287x001y Typical Application (Adjustable Output Voltage Type)

## Recommended Components

Symbol	Descriptions
L1, L2	VLF302510M-4R7M, TDK DFE252010C, TOKO, 1269AS-H-4R7M=P2
C1 (C <sub>IN</sub> )	10 $\mu$ F, 2012 size, X5R T = 0.85 max
C2 (C <sub>OUTP</sub> )	10 $\mu$ F, 2012 size, X5R T = 0.85 max
C3 (C <sub>OUTN</sub> )	10 $\mu$ F, 2012 size, X5R T = 0.85 max

## TECHNICAL NOTES

The performance of a power source circuit using this device is highly dependent on a peripheral circuit. A peripheral component or the device mounted on PCB should not exceed a rated voltage, a rated current or a rated power. When designing a peripheral circuit, please be fully aware of the following points.

- Place a 10  $\mu$ F or more ceramic capacitor (C1) between the  $V_{CC}$  pin and the GND pin, or the  $PV_{CC}$  pin and the PGND pin in a shortest distance.
- Make GND and PGND to the same potential.
- Make  $V_{CC}$  and  $PV_{CC}$  to the same potential.
- Place a 10  $\mu$ F or more ceramic capacitor (C2) between the  $V_{OUTP}$  and the GND pin. Likewise, place a 10  $\mu$ F or more ceramic capacitor (C3) between the  $V_{OUTN}$  pin and the GND pin.
- For stable operation of the device, the R1287x provides a phase compensation circuit according to the values of inductors (L1, L2) and capacitors (C2, C3).

Use L1 or L2 which is having a low equivalent series resistance, having enough tolerable current and which is less likely to cause magnetic saturation. A large load current causes a significant drop of the inductance value. Therefore, select the inductor value in consideration of the amount of load current under using condition. A significant drop of the inductance value can cause an increase in the  $L_x$  peak current along with an increase in the load current. When the  $L_x$  peak current reaches the current limit, the  $L_x$  peak current limit circuit starts operating.

- **CH1 Output Voltage Setting (R1287x001y: Adjustable Output Voltage Type)**

The output voltage of CH1 ( $V_{OUTP}$ ) controls the output voltage of CH1 feedback pin voltage ( $V_{FBP}$ ) to 1.0 V.  $V_{OUTP}$ , depending on the resistors (R1 and R2), can be calculated as follows:

$$V_{OUTP} = V_{FBP} \times (R1 + R2) / R1$$

$V_{OUTP}$  can be set within the range of 4.5 V to 5.8 V. R1 between 20 k $\Omega$  to 60 k $\Omega$  is recommended.

- **CH2 Output Voltage Setting (R1287x001y: Adjustable Output Voltage Type)**

The output voltage of CH2 ( $V_{OUTN}$ ) controls the output voltage of CH2 feedback pin voltage ( $V_{FBN}$ ) to 0 V.

$V_{OUTN}$ , depending on the resistor (R3) and the  $V_{FBN}$  pin input current ( $I_{FBN}$ ), can be calculated as follows:

$$V_{OUTN} = -I_{FBN} \times R3$$

$V_{OUTN}$  can be set within the range of -4.5 V to -6.0 V. The recommended value for R3 is as follows:

<b><math>V_{OUTN}</math> Setting</b>	<b>R3</b>
-5.0 V	750 k $\Omega$
-5.4 V	810 k $\Omega$ (310 k $\Omega$ + 500 k $\Omega$ )
-5.6 V	840 k $\Omega$ (680 k $\Omega$ + 160 k $\Omega$ )



- **Phase Compensation of CH1 (R1287x001y: Adjustable Output Voltage Type)**

The phase compensation of CH1 can be delayed 180 degree because of the external components (L, C) and the load current. The phase delay causes the loss in phase margins and stability. Therefore, the phase advance should be ensured.

A zero-point can be formed with R1 and C4 as follows:

$$C4 \text{ [pF]} = 300 / R1 \text{ [k}\Omega\text{]}$$

## TIMING CHART

### Enable the EN1 pin first and then the EN2 pin

If the EN1 pin is switched from low to high, CH1 performs soft-start operation. If the EN2 pin is switched from low to high while the EN1 pin is high, CH2 will not perform soft-start operation until CH1 detects that the output voltage of CH1 ( $V_{OUTP}$ ) has reached the preset voltage.

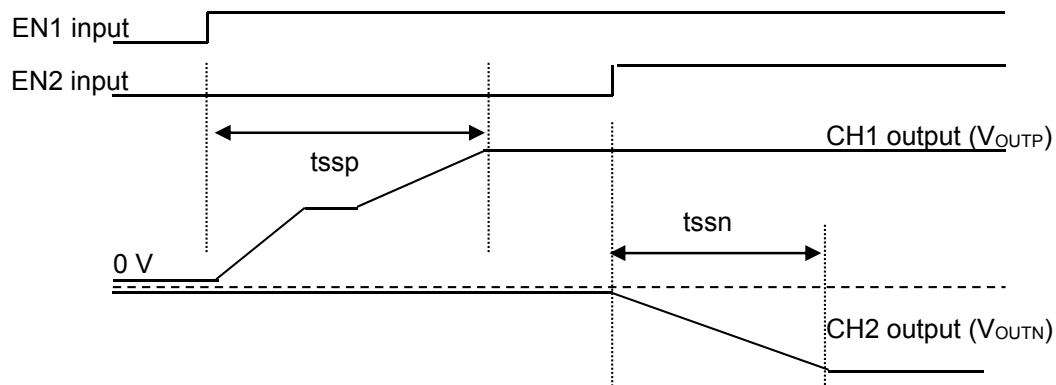

### Enable the EN2 pin first and then the EN1 pin

If the EN2 pin is switched from low to high, CH2 performs soft-start operation. If the EN1 pin is switched from low to high while the EN2 pin is high, CH1 will not perform soft-start operation until CH2 detects that the output voltage of CH2 ( $V_{OUTN}$ ) has reached the preset voltage.

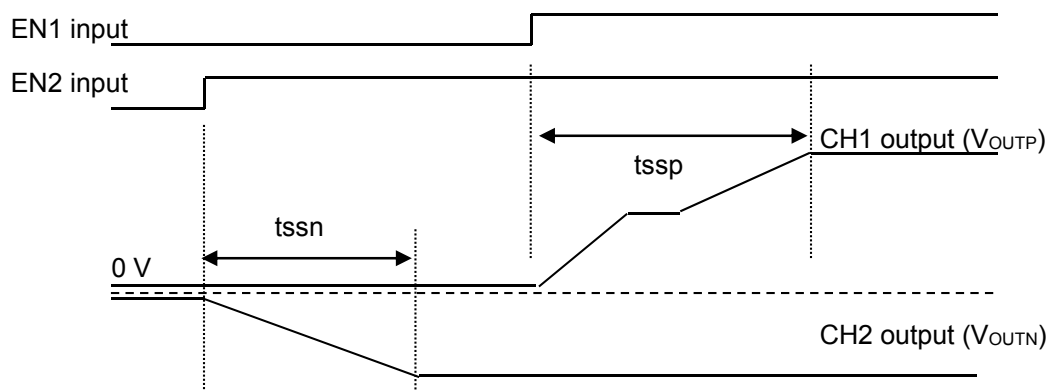

**Enable the EN1 Pin and the EN2 Pin while Short-circuiting**

If the EN1 pin and the EN2 pin are switched from low to high while they are short-circuited, CH1 performs soft-start operation. CH2 will not perform soft-start operation until CH1 detects that the output voltage of CH1 ( $V_{OUTP}$ ) has reached the preset voltage.

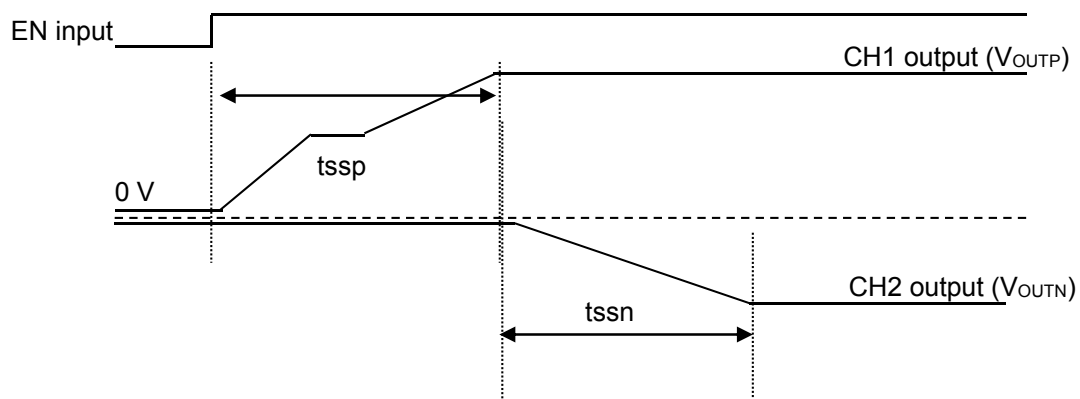

---

**R1287x**

---

NO.EA-325-160421

**Auto Discharge Function**

CH1 can be turned off by setting the EN1 pin low, and CH2 can be turned off by setting the EN2 pin low. Both CH1 and CH2 can be controlled individually.

If CH1/ CH2 is turned off by setting the EN1/ EN2 pin low, the auto-discharge function is enabled. The switch between the  $V_{OUTP}/ V_{OUTN}$  pin and the GND pin is turned on while the auto-discharge function is enabled. While both EN1 and EN2 pins are set low, the device is in the standby mode.

If CH1/ CH2 is turned off by other reasons, such as the  $V_{CC}$  pin voltage is dropped below the UVLO detector threshold or the timer-latch circuit is triggered due to short-circuit, the auto-discharge function is disabled.

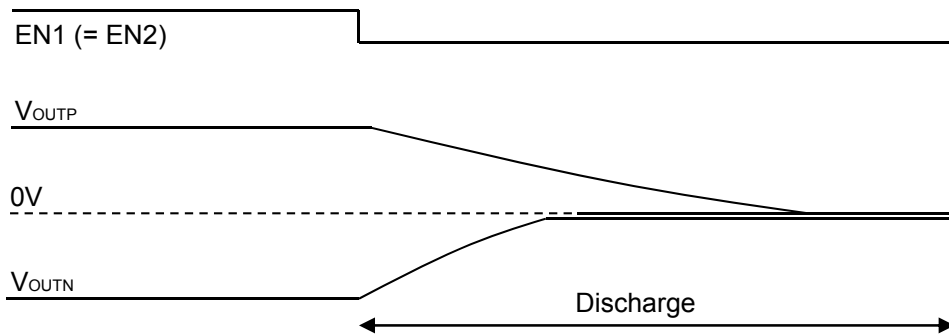
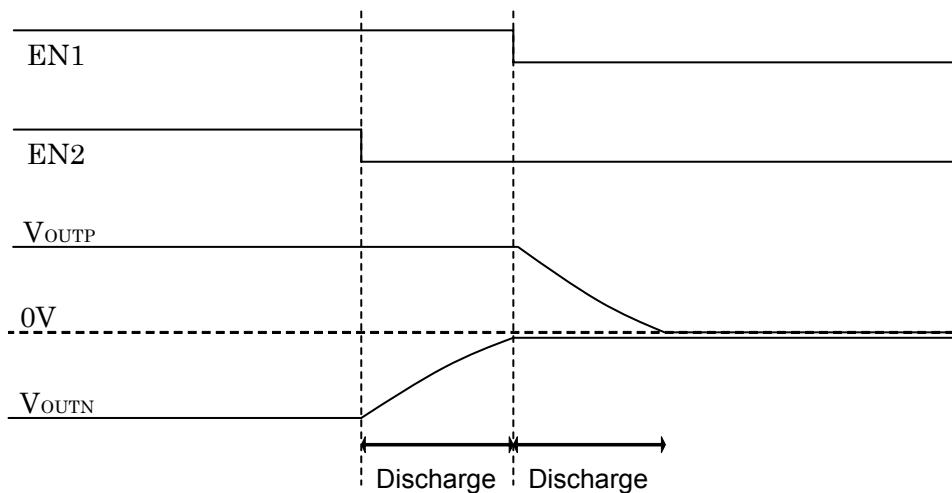
**Example of R1287xxxxB/C/D Falling Waveform****Example of R1287xxxxF/G/H Falling Waveform**

### **Thermal Shutdown Protection**

Thermal shutdown circuit detects the overheating of the device and stops the device operation to protect the device from damages. If the internal temperature of the device exceeds the thermal shutdown temperature, the thermal shutdown circuit turns off the drivers and synchronous transistors. If the internal temperature of the device falls below the thermal shutdown release temperature, the thermal shutdown circuit resets the device and restarts the device operation. Please note that the re-starting sequence of the device is performed by the following order: CH2 first and then CH1.

### **Low Output Voltage Detection Circuit for CH1**

If CH1 detects a significant voltage drop, after the completion of soft-start operation, CH1 resets the device and restarts the device operation. Please note that the re-starting sequence of the device is performed by the following order: CH1 first and then CH2.

### **L<sub>x</sub> Peak Current Limit Timer/ Latch-type Short Circuit Protection Timer**

The L<sub>x</sub> peak current limit circuit supervises the peak current of the inductor, which is passing through NMOS transistor of CH1 and PMOS transistor of CH2, in every switching cycle. If the peak current exceeds the L<sub>x</sub> peak current limit ( $I_{LIMLXP}/I_{LIMLXN}$ ), the L<sub>x</sub> peak current limit circuit turns off the NMOS transistor of CH1 or PMOS transistor of CH2.

The latch-type short circuit protection circuit latches the built-in drivers of CH1 and CH2 off to stop the operation of the device if the overcurrent state continues more than the protection delay time ( $t_{prot}$ ).

Please note that  $I_{LIMLXP}/I_{LIMLXN}$  and  $t_{prot}$  can be easily affected by self-heating and ambient environment. Also, the significant voltage drop or the unstable voltage caused by short-circuiting may affect on the protection operation and the delay time.

To release the latch-type short circuit protection, switch the EN1/ EN2 pin from high to low to reset the device or make the input voltage ( $V_{IN}$ ) lower than the UVLO detector threshold ( $V_{UVLO1}$ ).

During the softstart operation of CH1 and CH2, both L<sub>x</sub> peak current limit circuit timer and latch-type short circuit protection circuit timer operate until CH1 and CH2 reach their preset voltages. Therefore, the normal operation of circuit timers will not be affected by the abnormal completion of soft-start operation due to short-circuit or etc.

### **Protection Resistors between V<sub>OUTN</sub> and V<sub>OUTNS</sub> in Fixed Output Voltage Type (R1287Lxxxxy)**

If the V<sub>OUTNS</sub> pin and the V<sub>OUTN</sub> pin are connected to each other on PCB while the V<sub>OUTNS</sub> pin and the V<sub>CC</sub> pin or the EN2 pin are short-circuited due to some failure, the voltage higher than the rated voltage will be applied to the V<sub>OUTN</sub> pin. To prevent this, it is recommended that an approximately 100 Ω protection resistor be connected between the V<sub>OUTN</sub> pin and the V<sub>OUTNS</sub> pin.

## OUTPUT CURRENT AND EXTERNAL COMPONENTS

### Operation of CH1 and Output Current

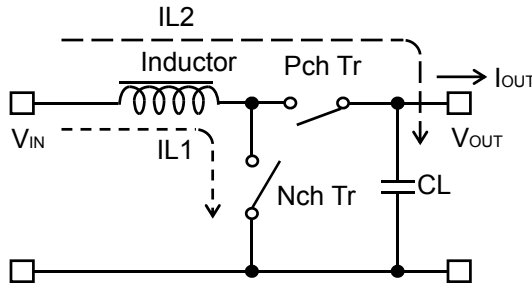

Basic Circuit

#### Discontinuous Inductor Current Mode

#### Continuous Inductor Current Mode

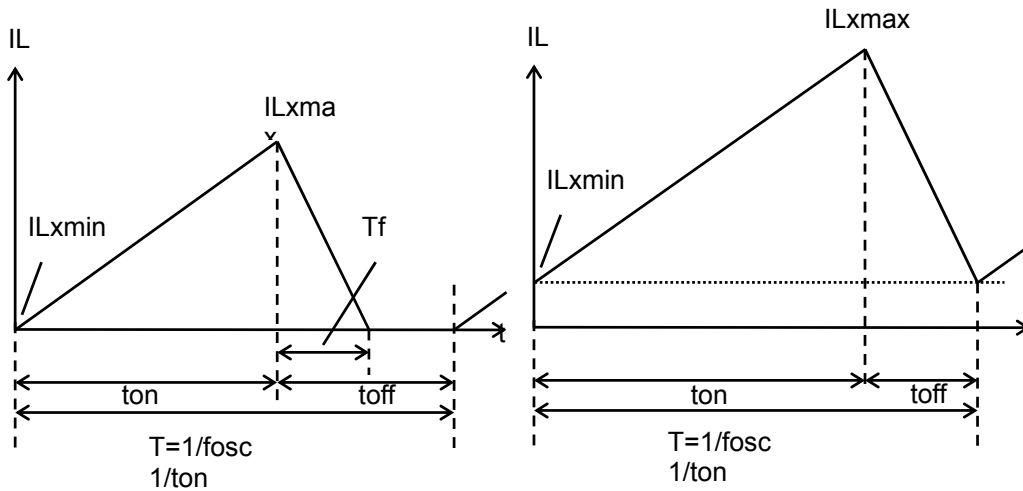

Inductor Current Waveshapes (IL) through Indictor (L)

The normal PWM control type of CH1 has two operation modes characterized by the continuity of inductor current: discontinuous inductor current mode and continuous inductor current mode.

When a NMOS Tr. is in On-state, the voltage to be applied to the inductor (L) is described as  $V_{IN}$ . An increase in the inductor current ( $IL1$ ) can be written as follows:

$$IL1 = V_{IN} \times t_{on} / L \dots \dots \dots \text{Formula 1}$$

In the CH1 circuit, the energy accumulated during the On-state is transferred into the capacitor even in the Off-state. A decrease in the inductor current ( $IL2$ ) can be written as follows:

$$IL2 = (V_{OUT} - V_{IN}) \times t_{f} / L \dots \dots \dots \text{Formula 2}$$

In the normal PWM control, IL1 and IL2 become continuous when  $t_f = t_{off}$ , which is called continuous inductor current mode.

When the device is in continuous inductor current mode and operates in steady-state conditions, the variations of IL1 and IL2 are same:

$$V_{IN} \times t_{on} / L = (V_{OUT} - V_{IN}) \times t_{off} / L \dots\dots\dots \text{Formula 3}$$

Therefore, the duty cycle in continuous inductor current mode is:

$$\text{Duty} = t_{on} / (t_{on} + t_{off}) = (V_{OUT} - V_{IN}) / V_{OUT} \dots\dots\dots \text{Formula 4}$$

If the input voltage ( $V_{IN}$ ) is equal to  $V_{OUT}$ , the output current ( $I_{OUT}$ ) is:

$$I_{OUT} = V_{IN}^2 \times t_{on} / (2 \times L \times V_{OUT}) \dots\dots\dots \text{Formula 5}$$

If  $I_{OUT}$  is larger than Formula 5, the device switches to continuous inductor current mode.

The  $L_x$  peak current flowing through L ( $I_{Lxmax}$ ) is:

$$I_{Lxmax} = I_{OUT} \times V_{OUT} / V_{IN} + V_{IN} \times t_{on} / (2 \times L) \dots\dots\dots \text{Formula 6}$$

$$I_{Lxmax} = I_{OUT} \times V_{OUT} / V_{IN} + V_{IN} \times T \times (V_{OUT} - V_{IN}) / (2 \times L \times V_{OUT}) \dots\dots\dots \text{Formula 7}$$

As a result,  $I_{Lxmax}$  becomes larger compared to  $I_{OUT}$ .

In discontinuous inductor current mode,  $I_{Lxmax}$  is:

$$I_{Lxmax} = \sqrt{(2 \times I_{OUT} \times (V_{OUT} - V_{IN}) \times T / L)} \dots\dots\dots \text{Formula 8}$$

The  $L_x$  peak current limit circuit operates in both modes if the  $I_{Lxmax}$  becomes more than the  $L_x$  peak current limit. When considering the input and output conditions or selecting the external components, please pay attention to  $I_{Lxmax}$ .

**Notes:** The above calculations are based on the ideal operation of the device. They do not include the losses caused by the external components or  $L_x$  switch. The actual maximum output current will be 70% to 90% of the above calculation results. Especially, if IL is large or  $V_{IN}$  is low, it may cause the switching losses.

**Operation of CH2 and Output Current**

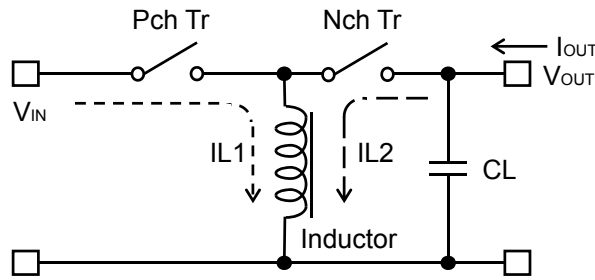

**Basic Circuit**

**Discontinuous Inductor Current Mode**

**Continuous Inductor Current Mode**

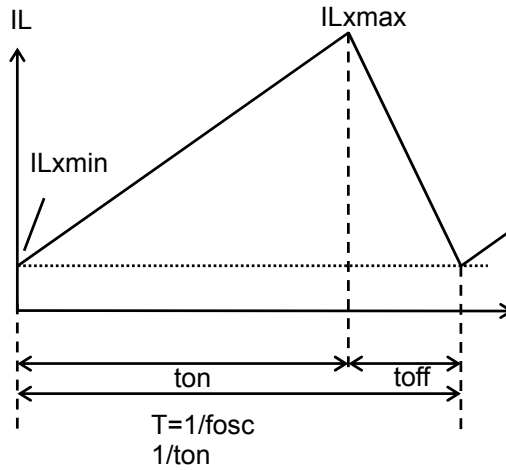
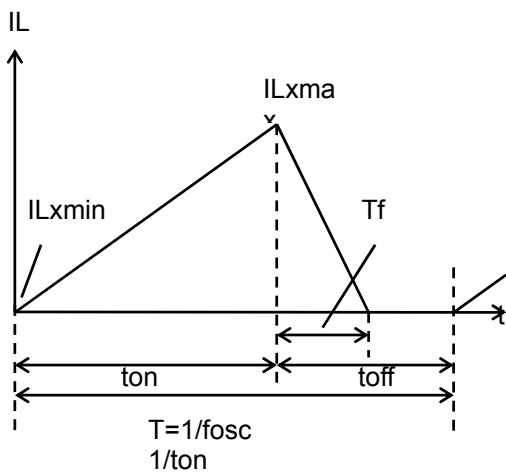

**Inductor Current Waveshapes (IL) through Inductor (L)**

The normal PWM control type of CH2 has two operation modes characterized by the continuity of inductor current: discontinuous inductor current mode and continuous inductor current mode.

When a PMOS Tr. is in ON-state, the voltage to be applied to the inductor (L) is described as VIN. An increase in the inductor current (IL1) can be written as follows:

$$IL1 = V_{IN} \times t_{on} / L \dots \dots \dots \text{Formula 9}$$

In the CH2 circuit, the energy accumulated during the On-state is transferred into the capacitor even in the Off-state. A decrease in the inductor current (IL2) can be written as follows:

$$IL2 = |V_{OUT}| \times t_f / L \dots \dots \dots \text{Formula 10}$$



In the normal PWM control type, when  $t_f = t_{off}$ , the inductor current will be continuous and the operation of CH2 will be continuous inductor current mode. When the device is in continuous inductor current mode and operates in steady-state conditions, the variation of  $I_{L1}$  and  $I_{L2}$  are same:

$$V_{IN} \times t_{on} / L = |V_{OUT}| \times t_{off} / L \cdots \cdots \cdots \text{Formula 11}$$

Therefore, the duty cycle in continuous inductor current mode is:

$$\text{Duty} = t_{on} / (t_{on} + t_{off}) = |V_{OUT}| / (|V_{OUT}| + V_{IN}) \cdots \cdots \cdots \text{Formula 12}$$

If the input voltage ( $V_{IN}$ ) equal to  $V_{OUT}$ , the output current ( $I_{OUT}$ ) is:

$$I_{OUT} = V_{IN}^2 \times t_{on} / (2 \times L \times |V_{OUT}|) \cdots \cdots \cdots \text{Formula 13}$$

If  $I_{OUT}$  is larger than Formula 13, the device switches to continuous inductor current mode.

The  $L_x$  peak current flowing through L ( $I_{Lxmax}$ ) is:

$$I_{Lxmax} = I_{OUT} \times (|V_{OUT}| + V_{IN}) / V_{IN} + V_{IN} \times t_{on} / (2 \times L) \cdots \cdots \cdots \text{Formula 14}$$

$$I_{Lxmax} = I_{OUT} \times (|V_{OUT}| + V_{IN}) / V_{IN} + V_{IN} \times |V_{OUT}| \times T / \{ 2 \times L \times (|V_{OUT}| + V_{IN}) \} \cdots \cdots \cdots \text{Formula 15}$$

As a result,  $I_{Lxmax}$  becomes larger compared to  $I_{OUT}$ .

In discontinuous inductor current mode,  $I_{Lxmax}$  is:

$$I_{Lxmax} = \sqrt{2 \times I_{OUT} \times |V_{OUT}| \times T / L} \cdots \cdots \cdots \text{Formula 16}$$

The  $L_x$  peak current limit circuit operates in both modes if the  $I_{Lxmax}$  becomes more than the  $L_x$  peak current limit. When considering the input and output conditions or selecting the external components, please pay attention to  $I_{Lxmax}$ .

**Notes:** The above calculations are based on the ideal operation of the device. They do not include the losses caused by the external components or  $L_x$  switch. The actual maximum output current will be 70% to 90% of the above calculation results. Especially, if  $I_L$  is large or  $V_{IN}$  is low, it may cause the switching losses.

**VFM Mode Operation (R1287xxxxB/F)**

The PWM/VFM auto switching control automatically switches from PWM mode to VFM mode in low output current in order to achieve high efficiency. With the VFM mode operation,  $t_{on}$  is preset inside the IC.

In continuous inductor current mode, if the inductor current is set to  $4.7\ \mu\text{H}$ ,  $t_{on}$  is set in a way that  $I_{Lmax}$  becomes 600 mA or less. In discontinuous inductor current mode, if the inductor current is set to  $4.7\ \mu\text{H}$ ,  $t_{on}$  is set in a way that  $I_{Lpp}$  becomes 400 mA or less.

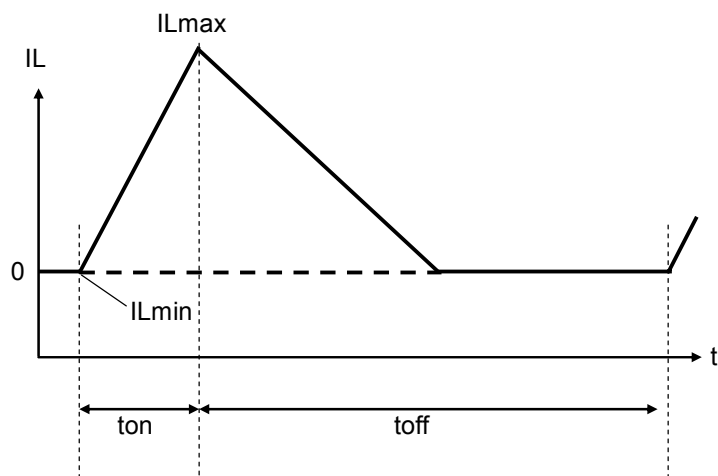
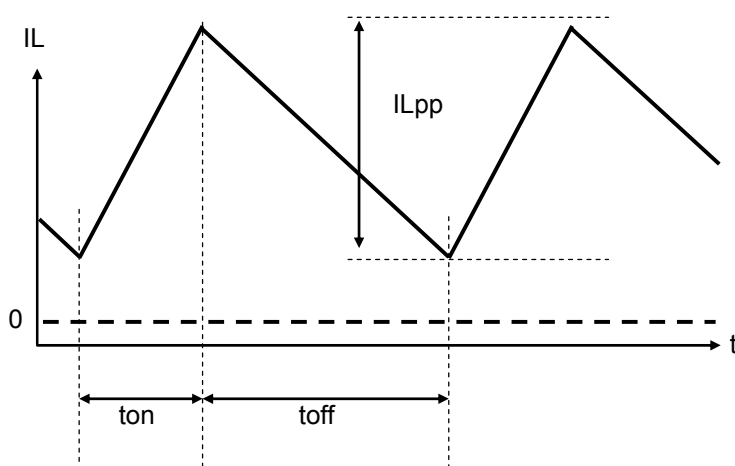
**VFM Mode Operation (Discontinuous Inductor Current Mode)****VFM Mode Operation (Continuous Inductor Current Mode)**

## PACKAGE INFORMATION

### POWER DISSIPATION (WLCSP-12-P1)

Power Dissipation ( $P_D$ ) of the package is dependent on PCB material, layout, and environmental conditions. The following conditions are used in this measurement.

#### Measurement Conditions

	Standard Test Land Pattern
Environment	Mounting on Board (Wind Velocity = 0 m/s)
Board Material	Glass Cloth Epoxy Plastic (Double-sided)
Board Dimensions	40 mm x 40 mm x 1.6 mm
Copper Ratio	Topside: Approx. 80%, Backside: Approx. 90% $\phi$ : 0.6 mm x 31 pcs

#### Measurement Result

( $T_a = 25^\circ\text{C}$ ,  $T_{j\text{max}} = 125^\circ\text{C}$ )

	Standard Test Land Pattern
Power Dissipation	1000 mW
Thermal Resistance	$\theta_{ja} = (125 - 25^\circ\text{C}) / 1.0 \text{ W} = 100^\circ\text{C/W}$

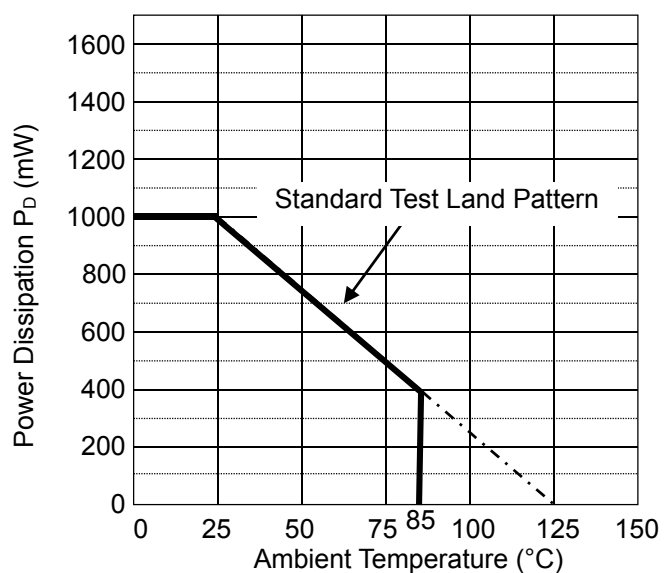

Power Dissipation vs. Ambient Temperature

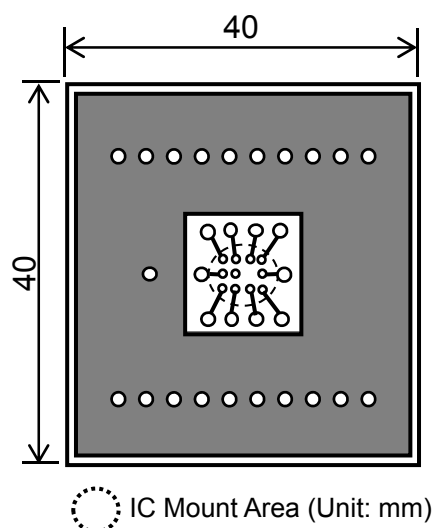

Measurement Board Pattern

---

**R1287x**

---

NO.EA-325-160421

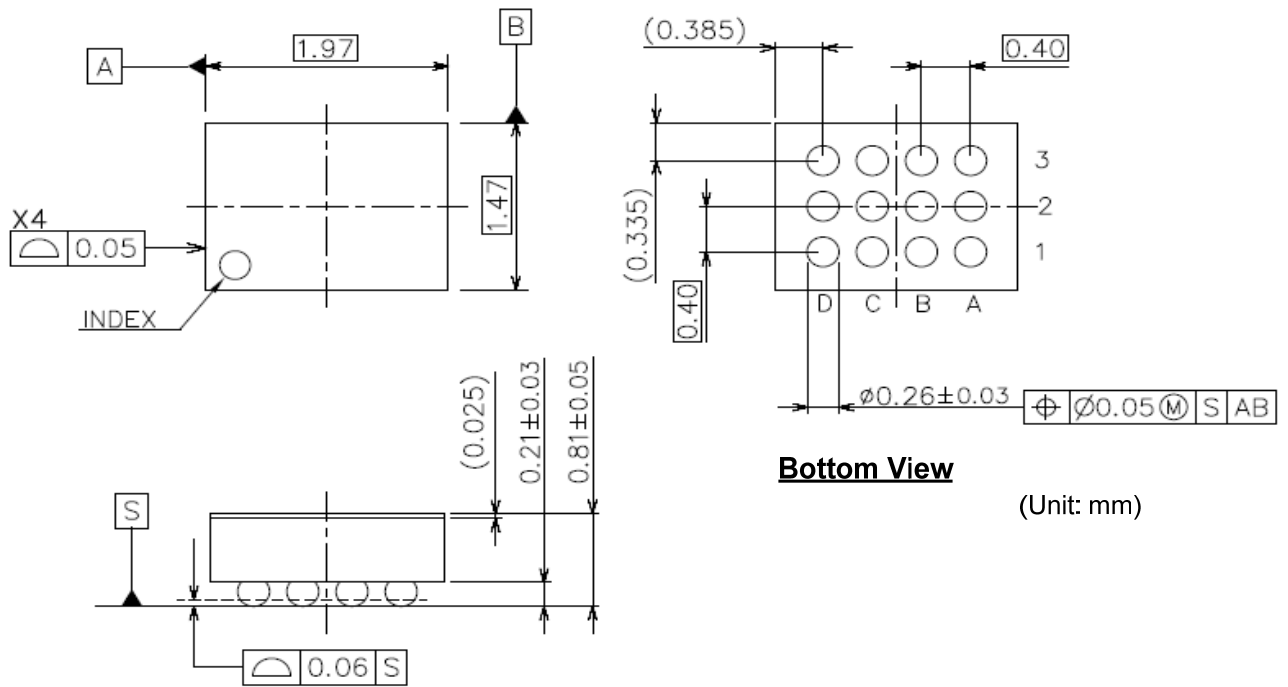
**PACKAGE DIMENSIONS (WLCSP-12-P1)****WLCSP-12-P1 Package Dimensions****MARK SPECIFICATION (WLCSP-12-P1)**

- ①: Product Code ... **Refer to MARK SPECIFICATION TABLE (WLCSP-12-P1)**  
②③: Lot Number ... Alphanumeric Serial Number

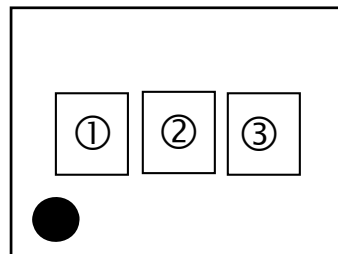
**WLCSP-12-P1 Mark Specification**

## MARK SPECIFICATION TABLE (WLCSP-12-P1)

R1287Z Mark Specification Table

Product Name	①	Product Name	①
R1287Z001B	R	R1287Z001F	R
R1287Z001C	R	R1287Z001G	R
R1287Z001D	R	R1287Z001H	R
R1287Z002B	R	R1287Z002F	R
R1287Z002C	R	R1287Z002G	R
R1287Z002D	R	R1287Z002H	R
R1287Z003B	R	R1287Z003F	R
R1287Z003C	R	R1287Z003G	R
R1287Z003D	R	R1287Z003H	R
R1287Z004B	R	R1287Z004F	R
R1287Z004C	R	R1287Z004G	R
R1287Z004D	R	R1287Z004H	R
R1287Z005B	R	R1287Z005F	R
R1287Z005C	R	R1287Z005G	R
R1287Z005D	R	R1287Z005H	R
R1287Z006B	R	R1287Z006F	R
R1287Z006C	R	R1287Z006G	R
R1287Z006D	R	R1287Z006H	R
R1287Z007B	R	R1287Z007F	R
R1287Z007C	R	R1287Z007G	R
R1287Z007D	R	R1287Z007H	R
R1287Z008B	R	R1287Z008F	R
R1287Z008C	R	R1287Z008G	R
R1287Z008D	R	R1287Z008H	R
R1287Z009B	R	R1287Z009F	R
R1287Z009C	R	R1287Z009G	R
R1287Z009D	R	R1287Z009H	R

# R1287x

NO.EA-325-160421

## POWER DISSIPATION (DFN3030-12)

Power Dissipation ( $P_D$ ) of the package is dependent on PCB material, layout, and environmental conditions. The following conditions are used in this measurement.

### Measurement Conditions

	Standard Test Land Pattern	JEDEC STD. 51-7 Test Land Pattern
Environment	Mounting on Board (Wind Velocity = 0 m/s)	Mounting on Board (Wind Velocity = 0 m/s)
Board Material	Glass Cloth Epoxy Plastic (Double-sided)	Glass Cloth Epoxy Plastic (Four-layers)
Board Dimensions	40 mm x 40 mm x 1.6 mm	76.2 mm x 114.3 mm x 1.6 mm
Copper Ratio	Top side: Approx. 50%, Back side: Approx. 50%	Top & Back sides: 60 mm x 60 mm, Approx. 10%, 2nd & 3rd layers: 74.2 mm x 74.2 mm, Approx. 100%
Through-holes	$\phi$ : 0.54 mm x 32 pcs	$\phi$ : 0.85 mm x 64 pcs Notes: The land pattern of Tab (Heat spreader), the inner layers and the backside pattern are connected by 0.3 mm through-hole.

### Measurement Result

( $T_a = 25^\circ\text{C}$ ,  $T_{jmax} = 125^\circ\text{C}$ )

	Standard Test Land Pattern	JEDEC STD. 51-7 Test Land Pattern
Power Dissipation	1000 mW	1950 mW
Thermal Resistance	$\theta_{ja} = (125 - 25^\circ\text{C}) / 1.0 \text{ W} = 100^\circ\text{C/W}$ $\theta_{jc} = 18^\circ\text{C/W}$	$\theta_{ja} = (125 - 25^\circ\text{C}) / 1.95 \text{ W} = 51.2^\circ\text{C/W}$ $\theta_{jc} = 5.9^\circ\text{C/W}$

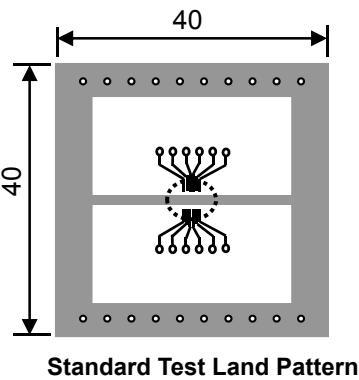
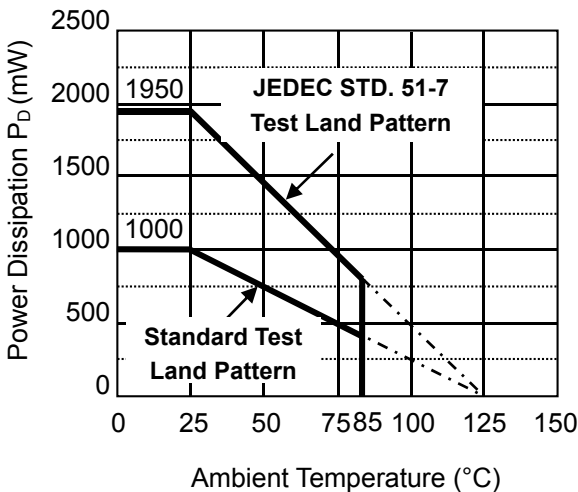

Standard Test Land Pattern

○ IC Mount Area (Unit: mm)

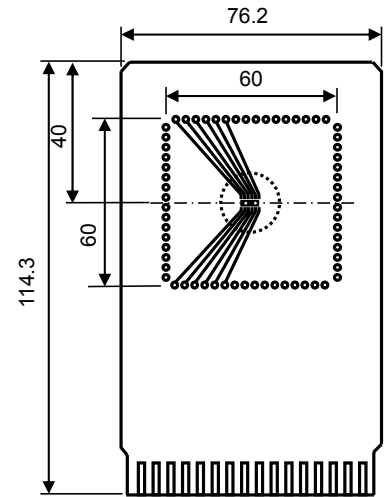

JEDEC STD. 51-7 Test Land Pattern

○ IC Mount Area (Unit: mm)

Power Dissipation vs. Ambient Temperature

Measurement Board Pattern

Measurement Board Pattern

**PACKAGE DIMENSIONS (DFN3030-12)**

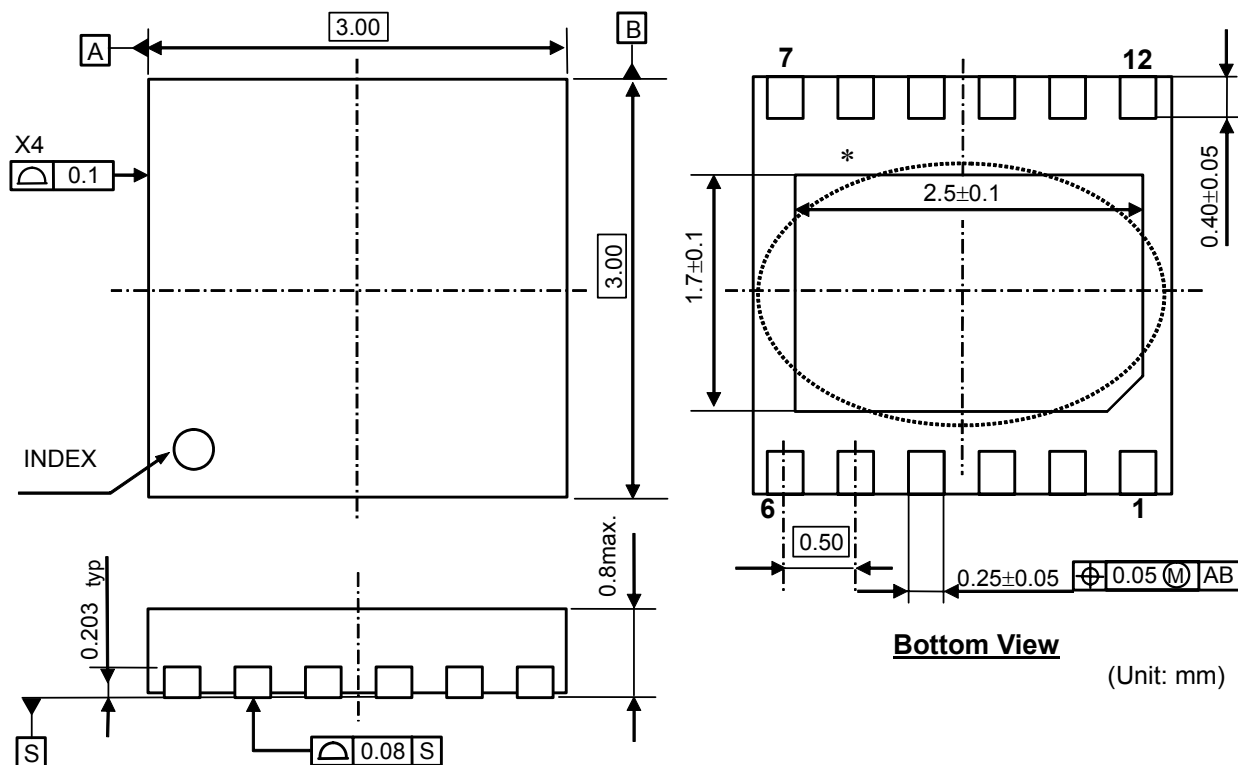

\* The tab on the bottom of the package enhances thermal performance and is electrically connected to GND (substrate level). It is recommended that the tab be connected to the ground plane on the board, or otherwise be left floating.

**DFN3030-12 Package Dimensions**

**MARK SPECIFICATION (DFN3030-12)**

①②③④: Product Code ... **Refer to MARK SPECIFICATION TABLE (DFN3030-12)**

⑤⑥: Lot Number ... Alphanumeric Serial Number

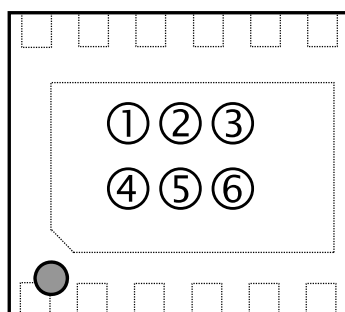

**DFN3030-12 Mark Specification**

---

**R1287x**

---

NO.EA-325-160421

**MARK SPECIFICATION TABLE (DFN3030-12)****R1287L Mark Specification Table**

<b>Product Name</b>	<b>①②③④</b>
R1287L001B	EK00
R1287L001C	EK01
R1287L001D	EK02
R1287L002B	EK03
R1287L002C	EK04
R1287L002D	EK05
R1287L003B	EK06
R1287L003C	EK07
R1287L003D	EK08
R1287L004B	EK09
R1287L004C	EK10
R1287L004D	EK11
R1287L005B	EK12
R1287L005C	EK13
R1287L005D	EK14
R1287L006B	EK15
R1287L006C	EK16
R1287L006D	EK17
R1287L007B	EK18
R1287L007C	EK19
R1287L007D	EK20
R1287L008B	EK21
R1287L008C	EK22
R1287L008D	EK23



## TYPICAL CHARACTERISTICS

Notes: Typical Characteristics are intended to be used as reference data; they are not guaranteed.

### 1) Output Voltage vs. Output Current

R1287x001B/F ( $V_{OUTP} = 5.0\text{ V}$ )  
( $T_a = 25^\circ\text{C}$ )

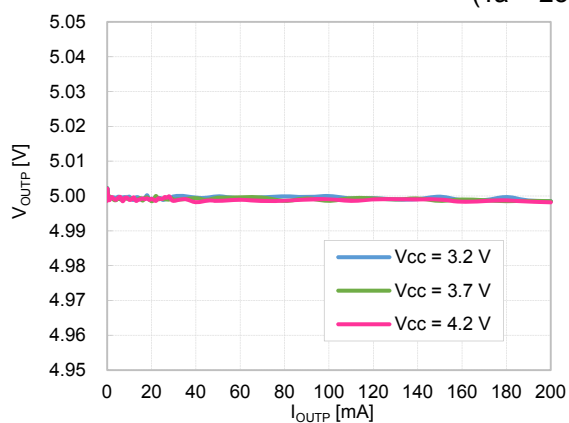

R1287x001C/G ( $V_{OUTP} = 5.0\text{ V}$ )  
( $T_a = 25^\circ\text{C}$ )

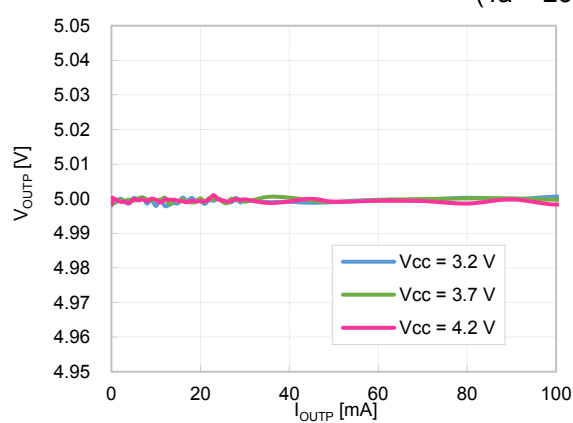

R1287x001D/H ( $V_{OUTP} = 5.0\text{ V}$ )  
( $T_a = 25^\circ\text{C}$ )

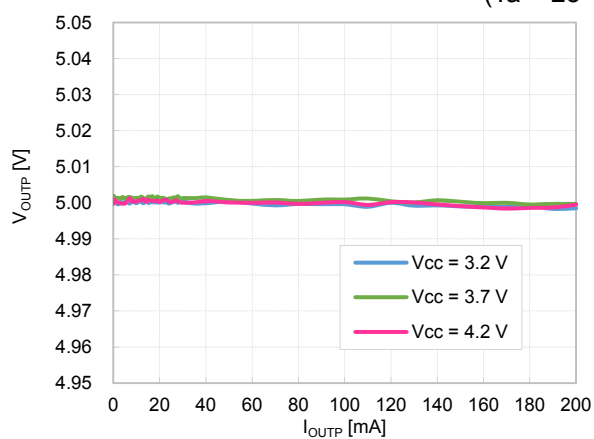

R1287x001B/F ( $V_{OUTP} = 5.6\text{ V}$ )  
( $T_a = 25^\circ\text{C}$ )

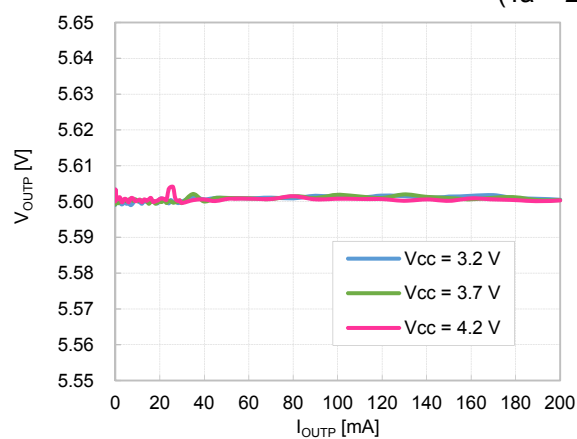

R1287x001C/G ( $V_{OUTP} = 5.6\text{ V}$ )  
( $T_a = 25^\circ\text{C}$ )

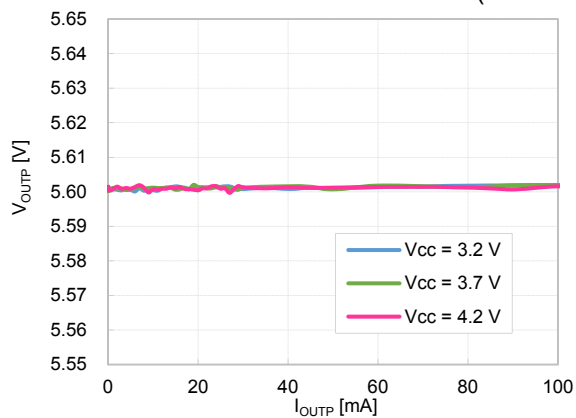

R1287x001B/F ( $V_{OUTN} = -5.0\text{ V}$ )  
( $T_a = 25^\circ\text{C}$ )

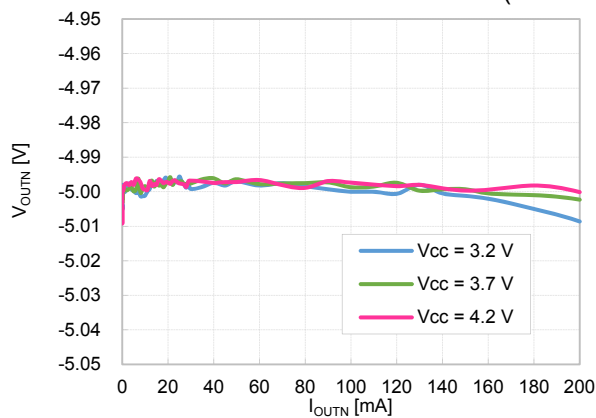

# R1287x

NO.EA-325-160421

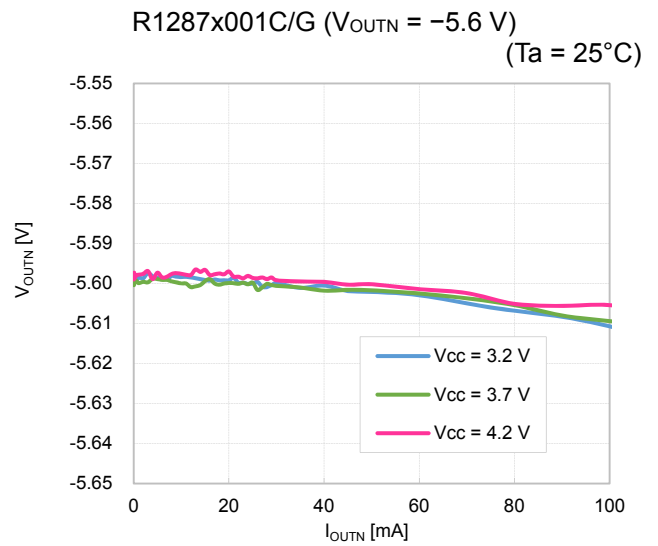
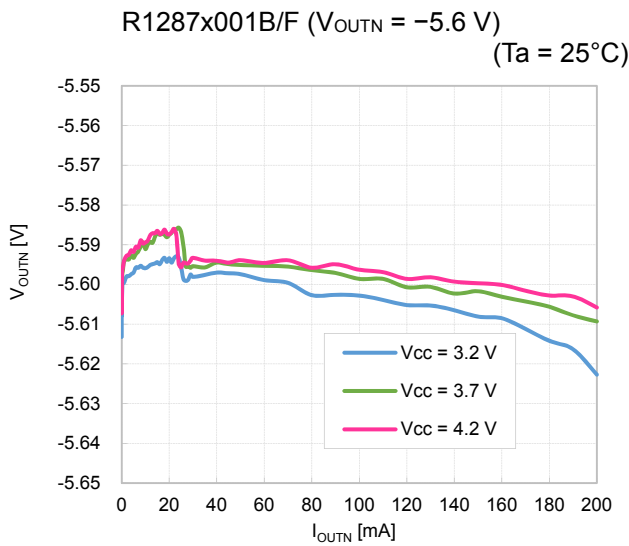
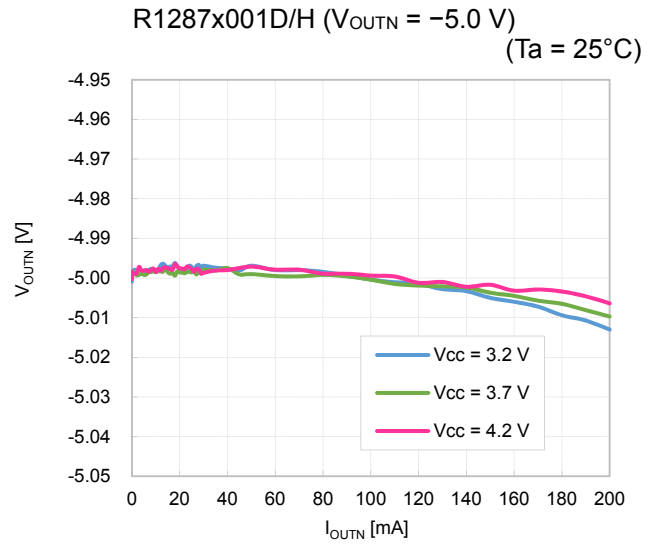
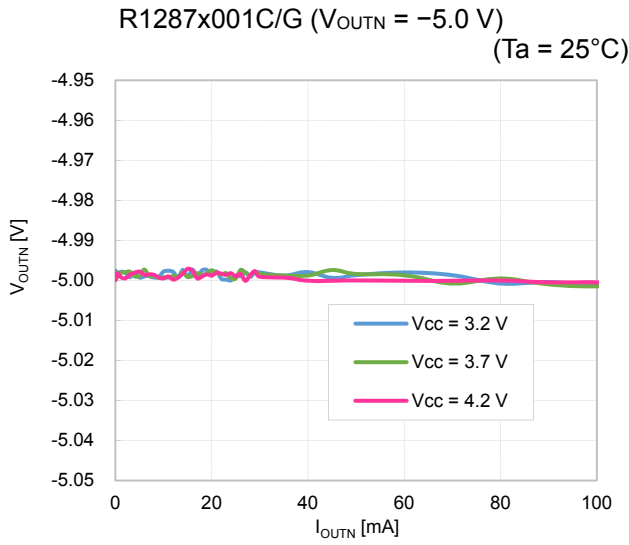

## 2) Efficiency vs. Output Current

R1287x001B/F ( $V_{OUTP} = 5.0\text{ V}$ ,  $V_{OUTN} = -5.0\text{ V}$ )  
( $T_a = 25^\circ\text{C}$ )

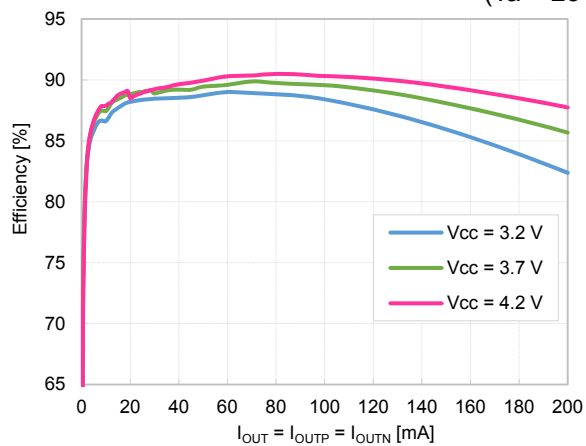

R1287x001C/G ( $V_{OUTP} = 5.0\text{ V}$ ,  $V_{OUTN} = -5.0\text{ V}$ )  
( $T_a = 25^\circ\text{C}$ )

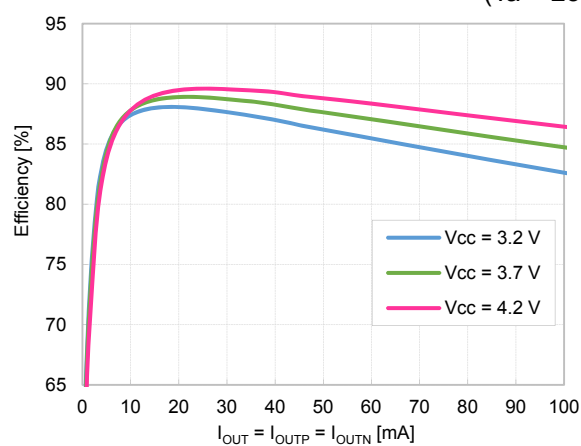

R1287x001D/H ( $V_{OUTP} = 5.0\text{ V}$ ,  $V_{OUTN} = -5.0\text{ V}$ )  
( $T_a = 25^\circ\text{C}$ )

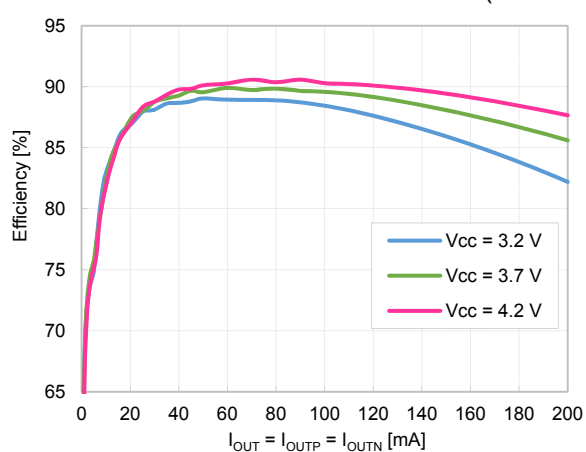

R1287x001B/F ( $V_{OUTP} = 5.6\text{ V}$ ,  $V_{OUTN} = -5.6\text{ V}$ )  
( $T_a = 25^\circ\text{C}$ )

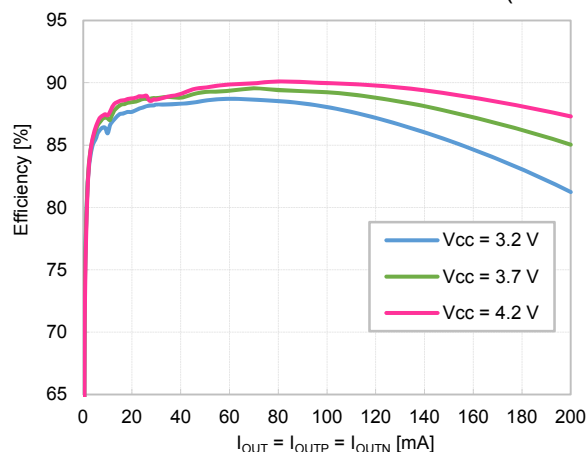

R1287x001C/G ( $V_{OUTP} = 5.6\text{ V}$ ,  $V_{OUTN} = -5.6\text{ V}$ )  
( $T_a = 25^\circ\text{C}$ )

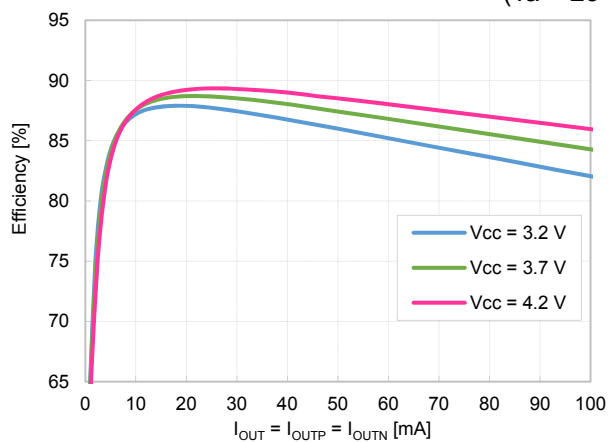

# R1287x

NO.EA-325-160421

### 3) Frequency vs. Output Current (VFM mode)

R1287x001B/F ( $V_{OUTP} = 5.0\text{ V}$ )  
( $T_a = 25^\circ\text{C}$ )

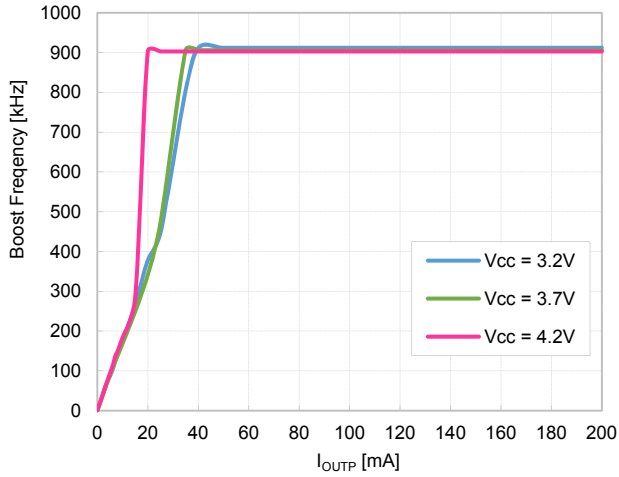

R1287x001B/F ( $V_{OUTP} = 5.6\text{ V}$ )  
( $T_a = 25^\circ\text{C}$ )

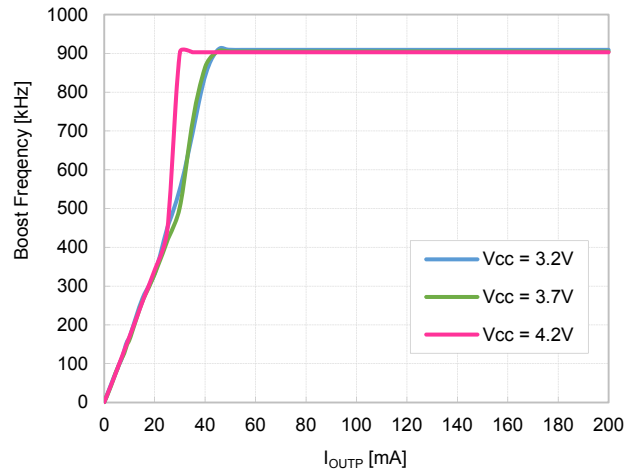

R1287x001B/F ( $V_{OUTN} = -5.0\text{ V}$ )  
( $T_a = 25^\circ\text{C}$ )

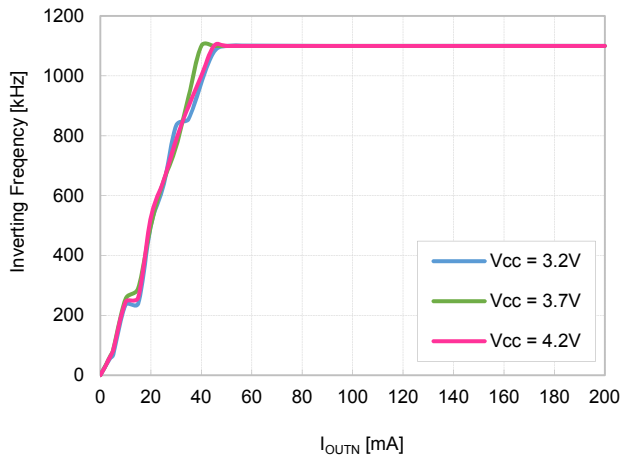

R1287x001B/F ( $V_{OUTN} = -5.6\text{ V}$ )  
( $T_a = 25^\circ\text{C}$ )

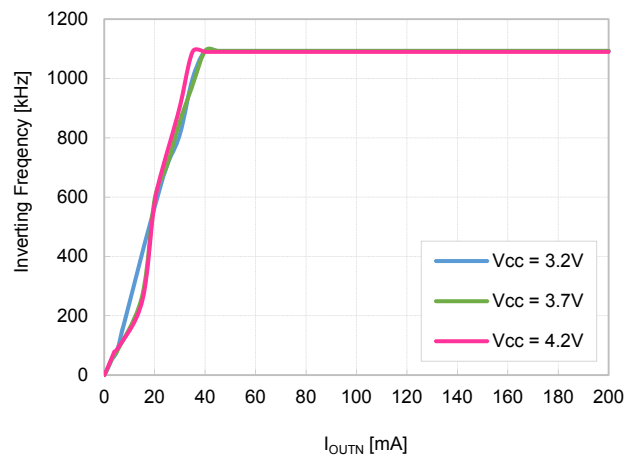

**4) Turn-on Waveform by EN1 & EN2**

$V_{CC} = PV_{CC} = 3.7\text{ V}$ ,  $I_{OUTP} = I_{OUTN} = 0\text{ mA}$   
 R1287x001B/F ( $V_{OUTP} = 5.0\text{ V}$ ,  $V_{OUTN} = -5.0\text{ V}$ )  
 ( $T_a = 25^\circ\text{C}$ )

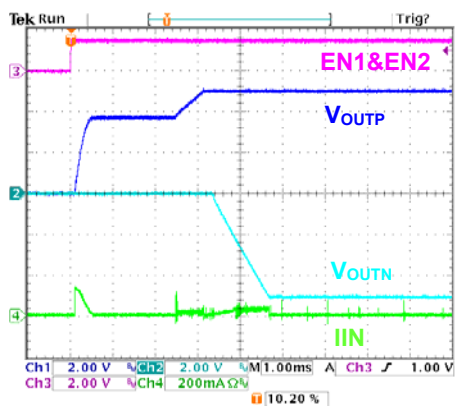

R1287x001C/G ( $V_{OUTP} = 5.0\text{ V}$ ,  $V_{OUTN} = -5.0\text{ V}$ )  
 ( $T_a = 25^\circ\text{C}$ )

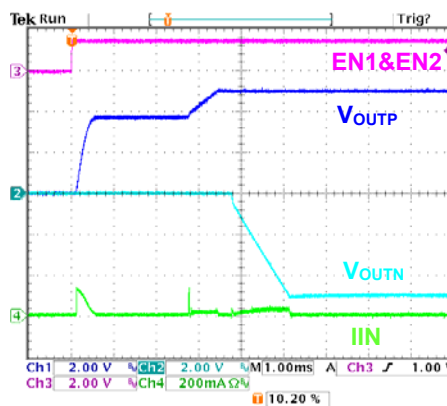

R1287x001D/H ( $V_{OUTP} = 5.0\text{ V}$ ,  $V_{OUTN} = -5.0\text{ V}$ )  
 ( $T_a = 25^\circ\text{C}$ )

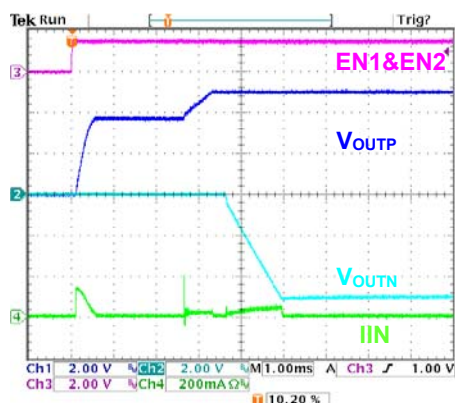

**5) Turn-on Waveform by EN1 -> EN2**

$V_{CC} = PV_{CC} = 3.7\text{ V}$ ,  $I_{OUTP} = I_{OUTN} = 0\text{ mA}$   
 R1287x001D/H ( $V_{OUTP} = 5.0\text{ V}$ ,  $V_{OUTN} = -5.0\text{ V}$ )  
 ( $T_a = 25^\circ\text{C}$ )

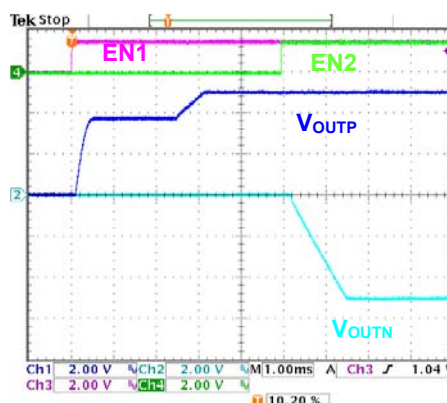

**6) Turn-on Waveform by EN2 -> EN1**

$V_{CC} = PV_{CC} = 3.7\text{ V}$ ,  $I_{OUTP} = I_{OUTN} = 0\text{ mA}$   
 R1287x001B/F ( $V_{OUTP} = 5.0\text{ V}$ ,  $V_{OUTN} = -5.0\text{ V}$ )  
 ( $T_a = 25^\circ\text{C}$ )

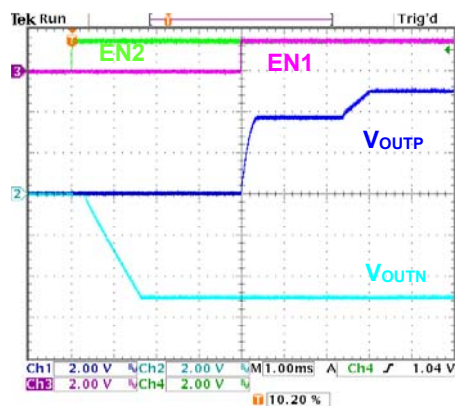

---

# R1287x

---

NO.EA-325-160421

## 7) Turn-off Waveform by EN1 & EN2

$V_{CC} = PV_{CC} = 3.7\text{ V}$ ,  $I_{OUTP} = I_{OUTN} = 0\text{ mA}$

R1287x001B/C/D ( $V_{OUTP} = 5.0\text{ V}$ ,  $V_{OUTN} = -5.0\text{ V}$ )  
( $T_a = 25^\circ\text{C}$ )

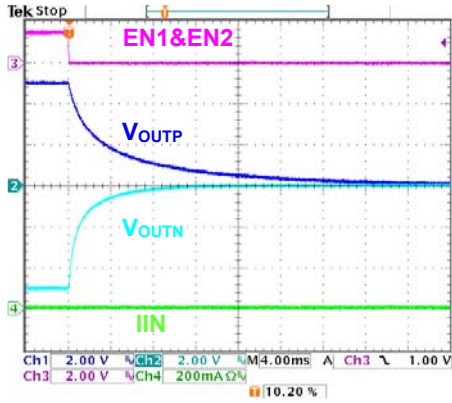

R1287x001F/G/H ( $V_{OUTP} = 5.0\text{ V}$ ,  $V_{OUTN} = -5.0\text{ V}$ )  
( $T_a = 25^\circ\text{C}$ )

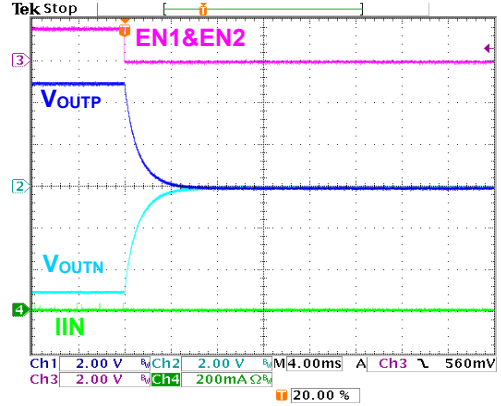

## 8) Load Transient Response Waveform

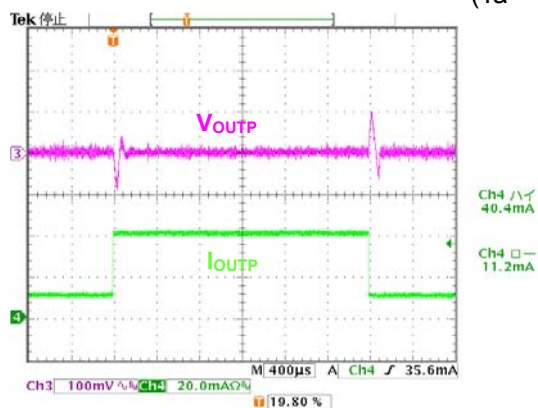
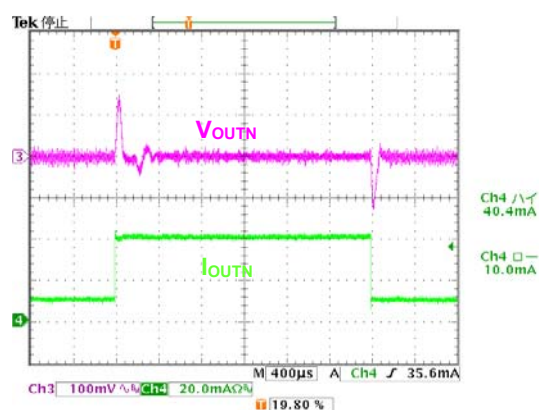
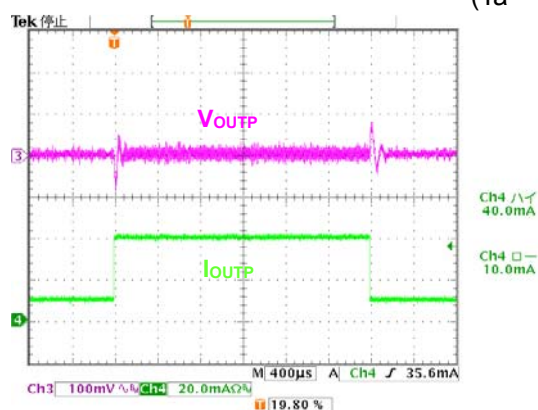
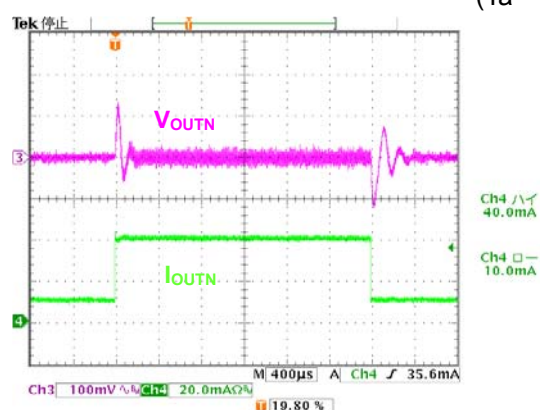
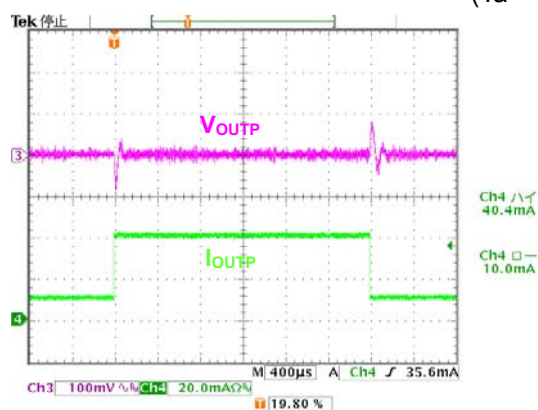
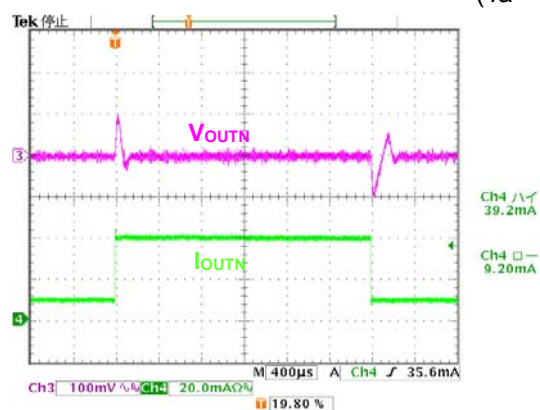
 $V_{CC} = PV_{CC} = 3.7\text{ V}$ R1287x001B/F ( $V_{OUTP} = 5.0\text{ V}$ ) $(T_a = 25^\circ\text{C})$ R1287x001B/F ( $V_{OUTN} = -5.0\text{ V}$ ) $(T_a = 25^\circ\text{C})$ R1287x001C/G ( $V_{OUTP} = 5.0\text{ V}$ ) $(T_a = 25^\circ\text{C})$ R1287x001C/G ( $V_{OUTN} = -5.0\text{ V}$ ) $(T_a = 25^\circ\text{C})$ R1287x001D/H ( $V_{OUTP} = 5.0\text{ V}$ ) $(T_a = 25^\circ\text{C})$ R1287x001D/H ( $V_{OUTN} = -5.0\text{ V}$ ) $(T_a = 25^\circ\text{C})$ 

# R1287x

NO.EA-325-160421

**9) Standby Current vs. Temperature**  
R1287xxxxy

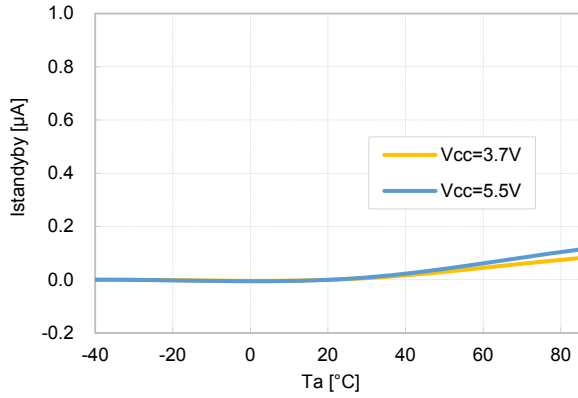

**10) UVLO Voltage vs. Temperature**  
R1287xxxxy

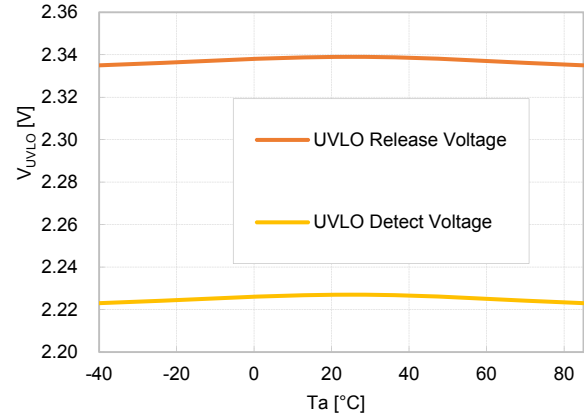

**11) V<sub>OUTP</sub> Voltage vs. Temperature**  
V<sub>CC</sub> = 3.7 V

R1287x002y

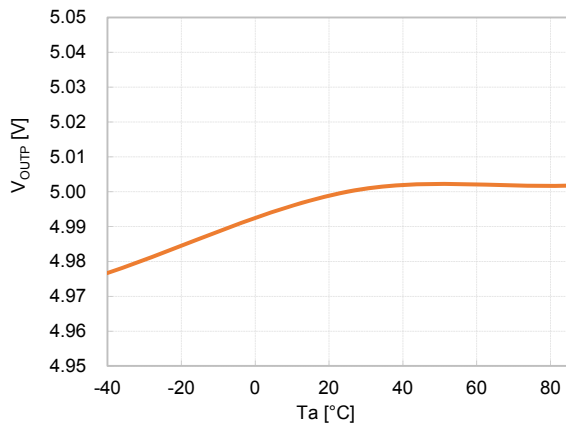

**12) V<sub>OUTN</sub> Voltage vs. Temperature**  
V<sub>CC</sub> = 3.7 V

R1287x002y

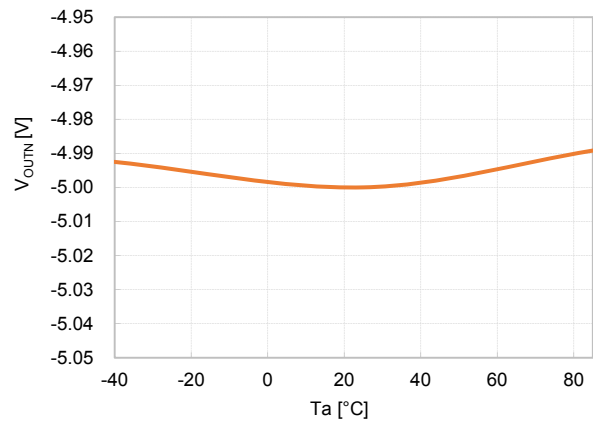

**13) V<sub>FBP</sub> Voltage vs. Temperature**  
V<sub>CC</sub> = 3.7 V

R1287x001y

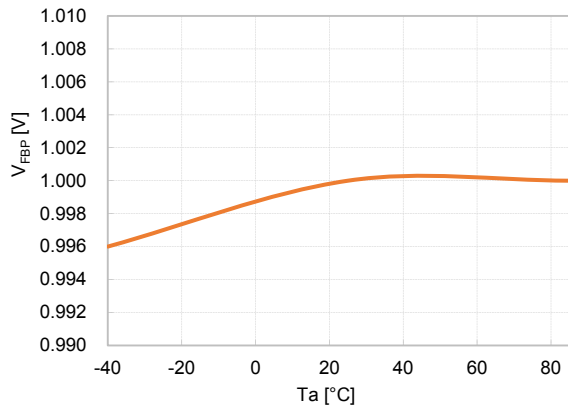

**14) V<sub>FBN</sub> Voltage vs. Temperature**  
V<sub>CC</sub> = 3.7 V

R1287x001y

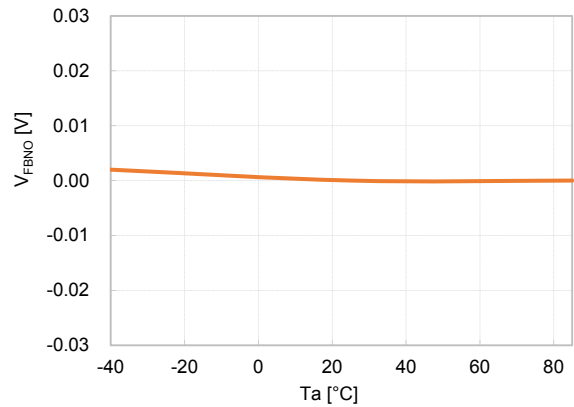



**15) I<sub>FBN</sub> Current vs. Temperature**

V<sub>CC</sub> = 3.7 V

R1287x001y

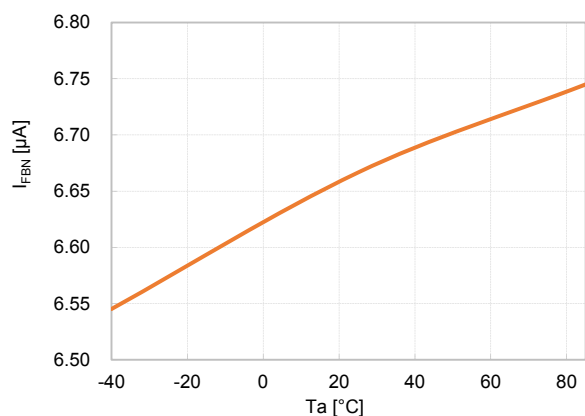

**16) PWM Oscillator Frequency vs. Temperature**

V<sub>CC</sub> = 3.7 V

R1287xxxxC

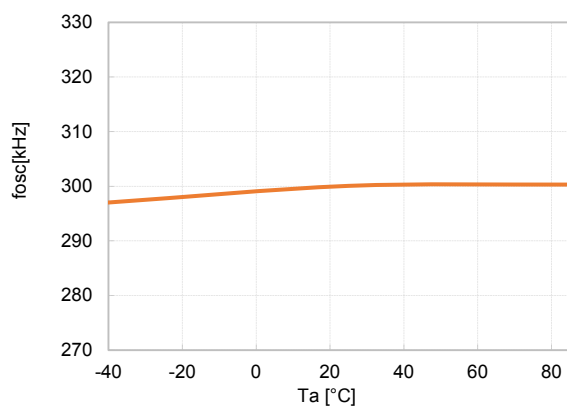

R1287xxxxD

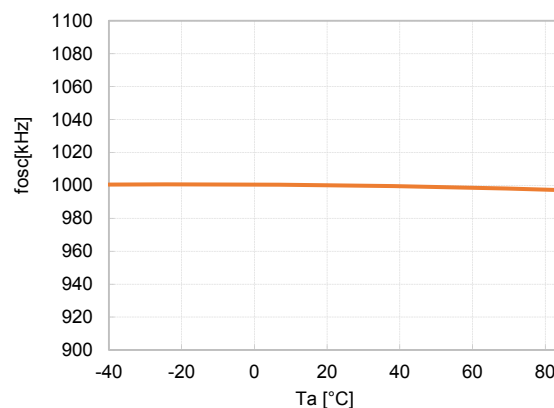

**17) CH1 Maximum Duty Cycle vs. Temperature**

V<sub>CC</sub> = 3.7 V

R1287xxxxy

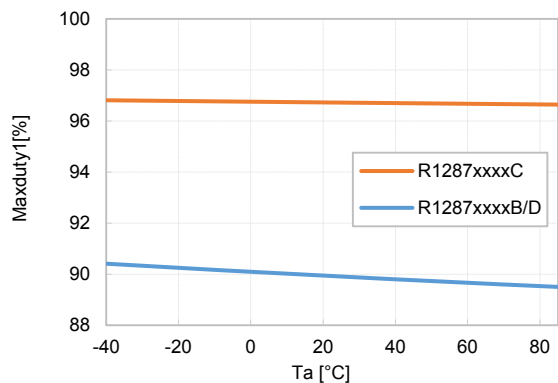

**18) CH2 Maximum Duty Cycle vs. Temperature**

V<sub>CC</sub> = 3.7 V

R1287xxxxy

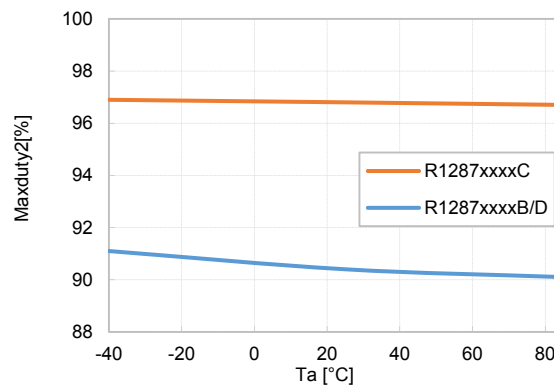

# R1287x

NO.EA-325-160421

**19) EN1 H/L Input Voltage vs. Temperature**  
 $V_{CC} = 3.7\text{ V}$

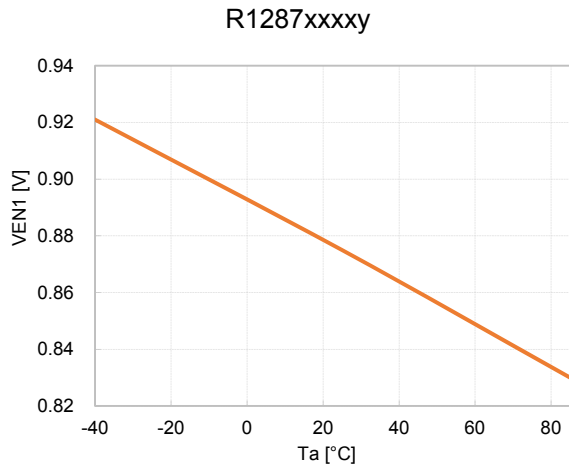

**20) EN2 H/L Input Voltage vs. Temperature**  
 $V_{CC} = 3.7\text{ V}$

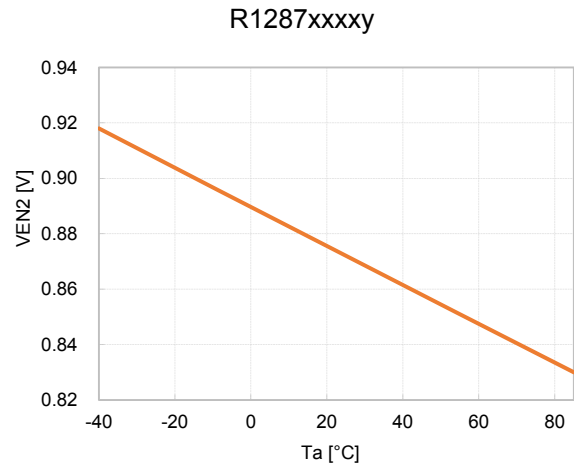

**21) Boost Nch Current Limit vs. Temperature**  
R1287xxxxxy

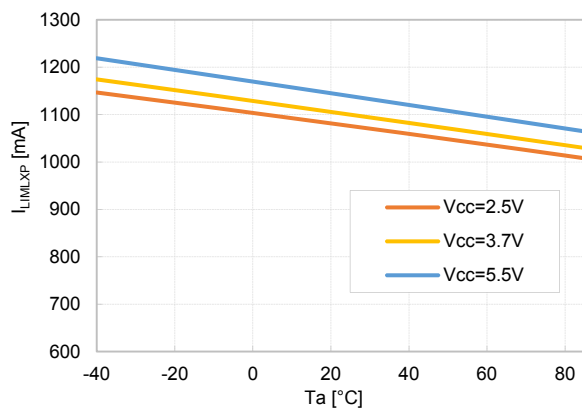

**22) Inverting Pch Current Limit vs. Temperature**  
R1287xxxxxy

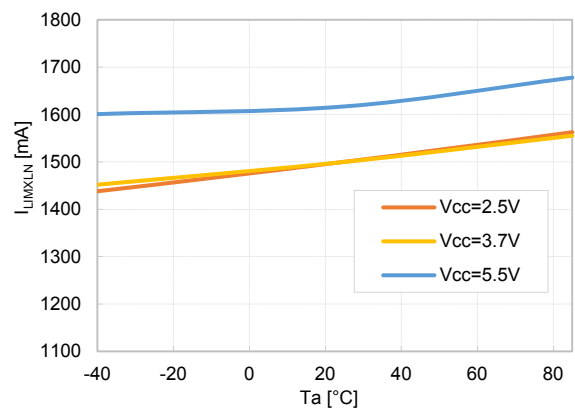

**23) CH1 Soft-Start Time vs. Temperature**  
R1287xxxxxy

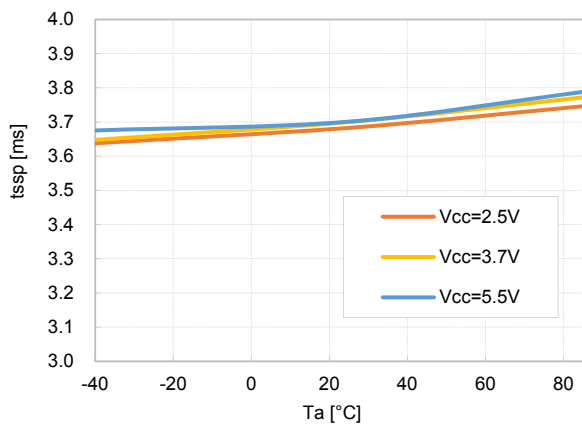

**24) CH2 Soft-Start Time vs. Temperature**  
R1287xxxxxy

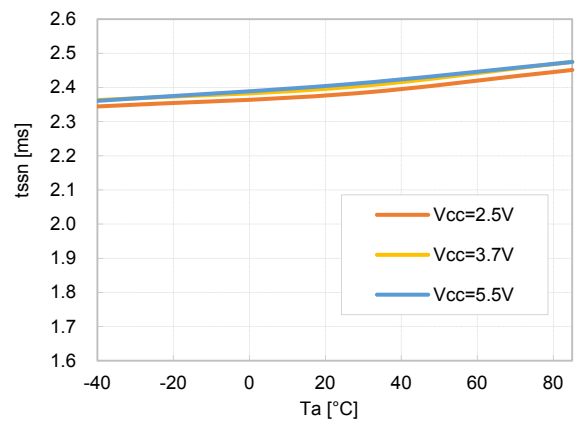

**25) Delay Time for Protection vs. Temperature** $V_{CC} = 3.7\text{ V}$ 

R1287xxxxy

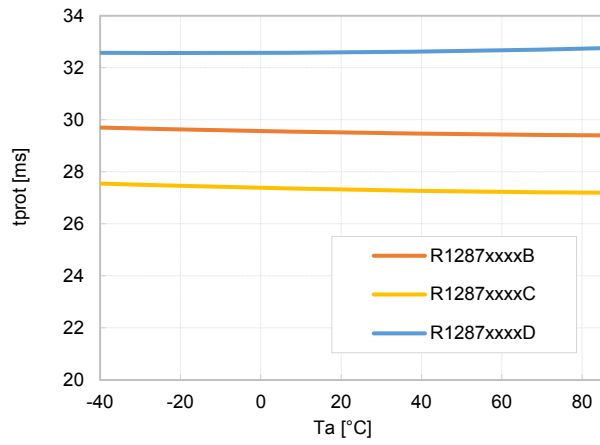



1. The products and the product specifications described in this document are subject to change or discontinuation of production without notice for reasons such as improvement. Therefore, before deciding to use the products, please refer to Ricoh sales representatives for the latest information thereon.
2. The materials in this document may not be copied or otherwise reproduced in whole or in part without prior written consent of Ricoh.
3. Please be sure to take any necessary formalities under relevant laws or regulations before exporting or otherwise taking out of your country the products or the technical information described herein.
4. The technical information described in this document shows typical characteristics of and example application circuits for the products. The release of such information is not to be construed as a warranty of or a grant of license under Ricoh's or any third party's intellectual property rights or any other rights.
5. The products listed in this document are intended and designed for use as general electronic components in standard applications (office equipment, telecommunication equipment, measuring instruments, consumer electronic products, amusement equipment etc.). Those customers intending to use a product in an application requiring extreme quality and reliability, for example, in a highly specific application where the failure or misoperation of the product could result in human injury or death (aircraft, spacevehicle, nuclear reactor control system, traffic control system, automotive and transportation equipment, combustion equipment, safety devices, life support system etc.) should first contact us.
6. We are making our continuous effort to improve the quality and reliability of our products, but semiconductor products are likely to fail with certain probability. In order to prevent any injury to persons or damages to property resulting from such failure, customers should be careful enough to incorporate safety measures in their design, such as redundancy feature, fire containment feature and fail-safe feature. We do not assume any liability or responsibility for any loss or damage arising from misuse or inappropriate use of the products.
7. Anti-radiation design is not implemented in the products described in this document.
8. Please contact Ricoh sales representatives should you have any questions or comments concerning the products or the technical information.



**Ricoh is committed to reducing the environmental loading materials in electrical devices with a view to contributing to the protection of human health and the environment.**

Ricoh has been providing RoHS compliant products since April 1, 2006 and Halogen-free products since April 1, 2012.

**RICOH** RICOH ELECTRONIC DEVICES CO., LTD.

<http://www.e-devices.ricoh.co.jp/en/>

#### Sales & Support Offices

##### **RICOH ELECTRONIC DEVICES CO., LTD.**

**Higashi-Shinagawa Office (International Sales)**  
3-32-3, Higashi-Shinagawa, Shinagawa-ku, Tokyo 140-8655, Japan  
Phone: +81-3-5479-2857 Fax: +81-3-5479-0502

##### **RICOH EUROPE (NETHERLANDS) B.V.**

**Semiconductor Support Centre**  
Prof. W.H. Keesomlaan 1, 1183 DJ Amstelveen, The Netherlands  
Phone: +31-20-5474-309

##### **RICOH INTERNATIONAL B.V. - German Branch**

**Semiconductor Sales and Support Centre**  
Oberrather Strasse 6, 40472 Düsseldorf, Germany  
Phone: +49-211-6546-0

##### **RICOH ELECTRONIC DEVICES KOREA CO., LTD.**

3F, Haesung Bldg, 504, Teheran-ro, Gangnam-gu, Seoul, 135-725, Korea  
Phone: +82-2-2135-5700 Fax: +82-2-2051-5713

##### **RICOH ELECTRONIC DEVICES SHANGHAI CO., LTD.**

Room 403, No.2 Building, No.690 Bibo Road, Pu Dong New District, Shanghai 201203, People's Republic of China  
Phone: +86-21-5027-3200 Fax: +86-21-5027-3299

##### **RICOH ELECTRONIC DEVICES CO., LTD.**

**Taipei office**  
Room 109, 10F-1, No.51, Hengyang Rd., Taipei City, Taiwan (R.O.C.)  
Phone: +886-2-2313-1621/1622 Fax: +886-2-2313-1623

# Mouser Electronics

Authorized Distributor

Click to View Pricing, Inventory, Delivery & Lifecycle Information:

[Rico Electronics:](#)

[R1287Z003F-E2-F](#) [R1287Z008F-E2-F](#) [R1287Z001C-E2-F](#) [R1287Z008C-E2-F](#) [R1287Z009F-E2-F](#) [R1287Z001B-E2-F](#)

Компания «Океан Электроники» предлагает заключение долгосрочных отношений при поставках импортных электронных компонентов на взаимовыгодных условиях!

Наши преимущества:

- Поставка оригинальных импортных электронных компонентов напрямую с производств Америки, Европы и Азии, а так же с крупнейших складов мира;
- Широкая линейка поставок активных и пассивных импортных электронных компонентов (более 30 млн. наименований);
- Поставка сложных, дефицитных, либо снятых с производства позиций;
- Оперативные сроки поставки под заказ (от 5 рабочих дней);
- Экспресс доставка в любую точку России;
- Помощь Конструкторского Отдела и консультации квалифицированных инженеров;
- Техническая поддержка проекта, помощь в подборе аналогов, поставка прототипов;
- Поставка электронных компонентов под контролем ВП;
- Система менеджмента качества сертифицирована по Международному стандарту ISO 9001;
- При необходимости вся продукция военного и аэрокосмического назначения проходит испытания и сертификацию в лаборатории (по согласованию с заказчиком);
- Поставка специализированных компонентов военного и аэрокосмического уровня качества (Xilinx, Altera, Analog Devices, Intersil, Interpoint, Microsemi, Actel, Aeroflex, Peregrine, VPT, Syfer, Eurofarad, Texas Instruments, MS Kennedy, Miteq, Cobham, E2V, MA-COM, Hittite, Mini-Circuits, General Dynamics и др.);

Компания «Океан Электроники» является официальным дистрибьютором и эксклюзивным представителем в России одного из крупнейших производителей разъемов военного и аэрокосмического назначения «JONHON», а так же официальным дистрибьютором и эксклюзивным представителем в России производителя высокотехнологичных и надежных решений для передачи СВЧ сигналов «FORSTAR».



## JONHON

«JONHON» (основан в 1970 г.)

Разъемы специального, военного и аэрокосмического назначения:

(Применяются в военной, авиационной, аэрокосмической, морской, железнодорожной, горно- и нефтедобывающей отраслях промышленности)

«FORSTAR» (основан в 1998 г.)

ВЧ соединители, коаксиальные кабели,  
кабельные сборки и микроволновые компоненты:

(Применяются в телекоммуникациях гражданского и специального назначения, в средствах связи, РЛС, а так же военной, авиационной и аэрокосмической отраслях промышленности).



Телефон: 8 (812) 309-75-97 (многоканальный)

Факс: 8 (812) 320-03-32

Электронная почта: [ocean@oceanchips.ru](mailto:ocean@oceanchips.ru)

Web: <http://oceanchips.ru/>

Адрес: 198099, г. Санкт-Петербург, ул. Калинина, д. 2, корп. 4, лит. А