

GT11 Series

— Connectors for coaxial cables —

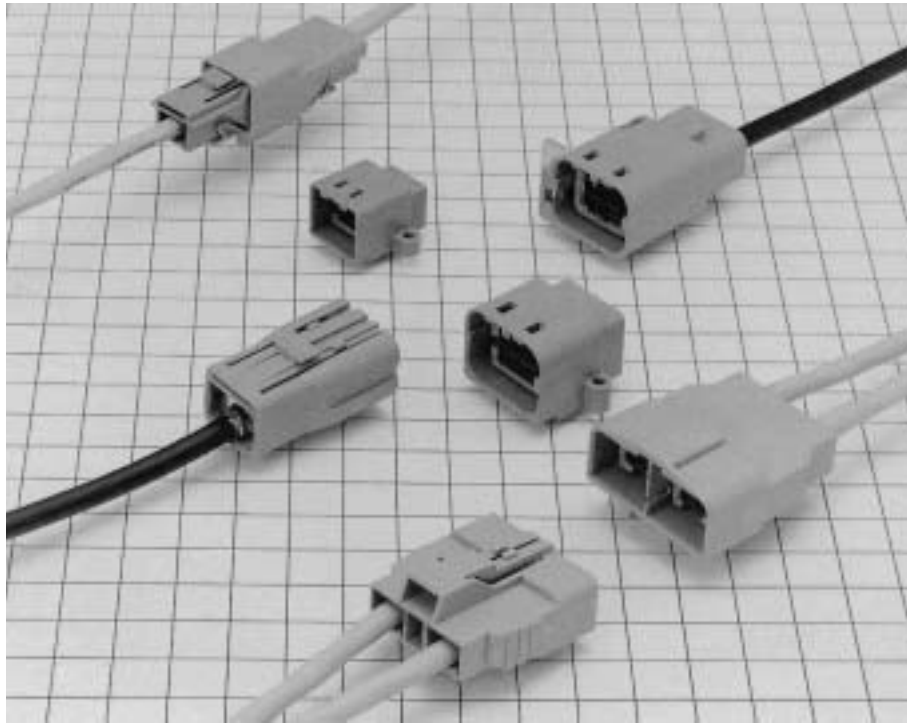

■ Features

- **Cost efficient termination**
Highly efficient and reliable single motion crimp termination allows high volume production with semi-automatic equipment.
- **Lock-release latching system**
- **Shock / vibration resistant electrical connections**
- **Verification of the full contact insertion**

For Double-Conductor coaxial shielded cable

F Connectors

● Outer terminals

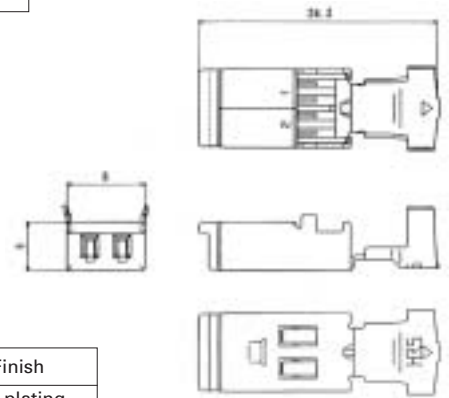

Part Number	CL No.	Applicable Cable
GT11-2S-5.2C	761-0002-3	4.5 to 5.2mm
GT11-2S-6.0C	761-0028-7	5.8 to 6.2mm

Item	Material	Finish
Outer terminal	Brass	Tin plating
Insulator	PT	Color: Dark gray

* The suitable terminals might differ depending on the internal structure of the cable.

● Inner Terminals

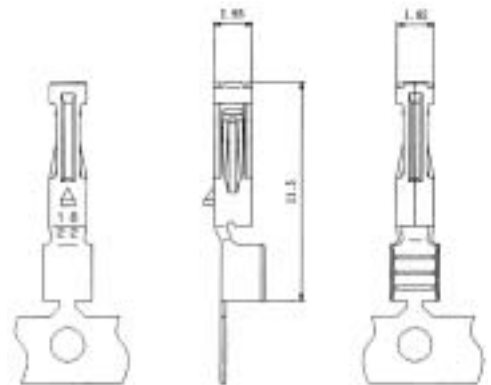

Part Number	CL No.	Conductor Size (AWG)	Material	Finish	Packaging
GT11-1822SCF	761-0004-9	#18 to 22	Brass	Tin plating	8,000 pcs. per reel
GT11-2428SCF	761-0020-5	#24 to 28			

M Connectors

● Outer terminals

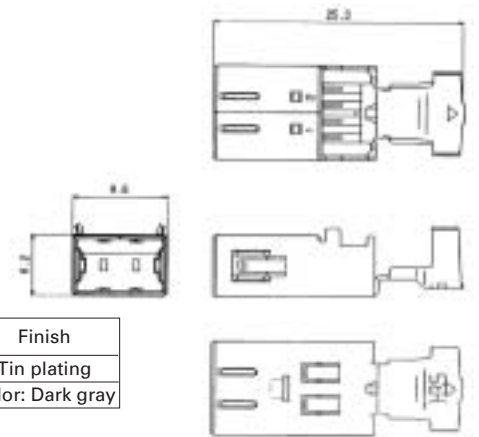

Part Number	CL No.	Applicable Cable
GT11-2P-5.2C	761-0001-0	4.5 to 5.2mm
GT11-2P-6.0C	761-0027-4	5.8 to 6.2mm

Item	Material	Finish
Outer terminal	Brass	Tin plating
Insulator	PT	Color: Dark gray

* The suitable terminals might differ depending on the internal structure of the cable.

● Inner Terminals

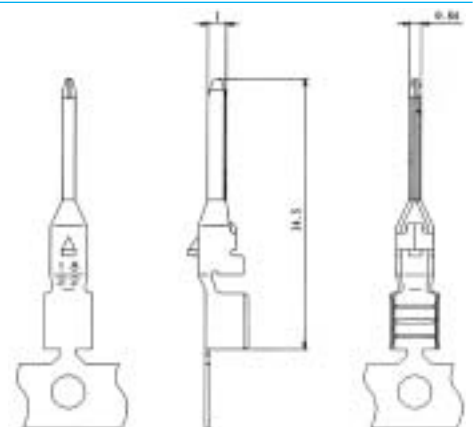

Part Number	CL No.	Conductor Size (AWG)	Material	Finish	Packaging
GT11-1822PCF	761-0003-6	#18 to 22	Brass	Tin plating	8,000 pcs. per reel
GT11-2428PCF	761-0019-6	#24 to 28			

For Double-Conductor coaxial cable

F Connectors

● Housing

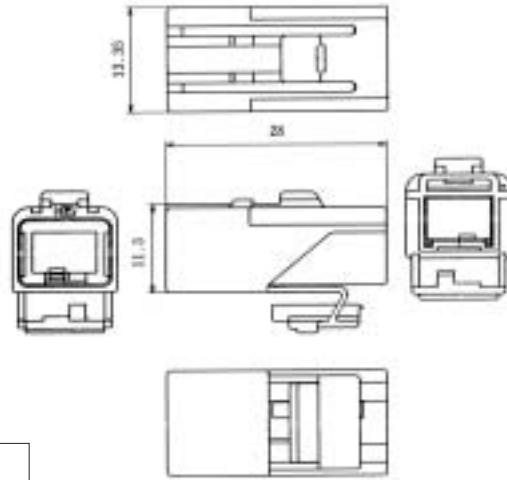

◆ Shown with inserted retainer



Part Number	CL No.	Material	Color
GT11-2S-HU	761-0005-1	PBT	Light gray

M Connectors

● Housing

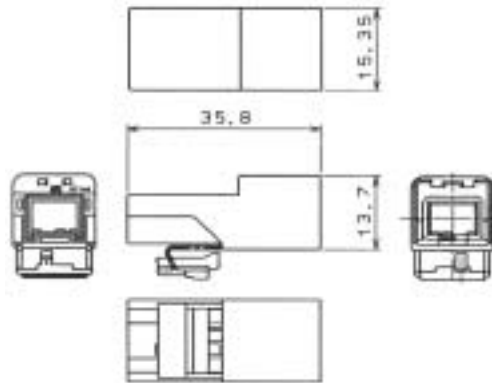

◆ Shown with inserted retainer



Part Number	CL No.	Material	Color
GT11-2P-HU	761-0006-4	PBT	Light gray

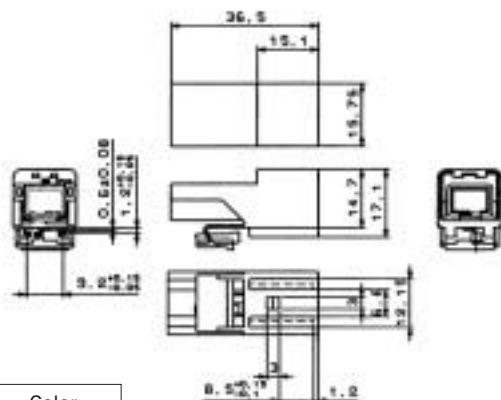

◆ Shown with inserted retainer



◆ Fully mated connector assemblies

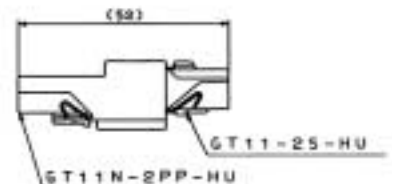

Part Number	CL No.	Material	Color
GT11N-2PP-HU	761-0008-0	PBT	Light gray

M Connectors

● Housing

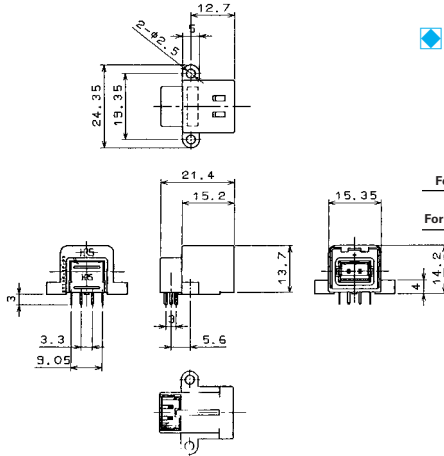

◆ Recommended Board Mounting Pattern

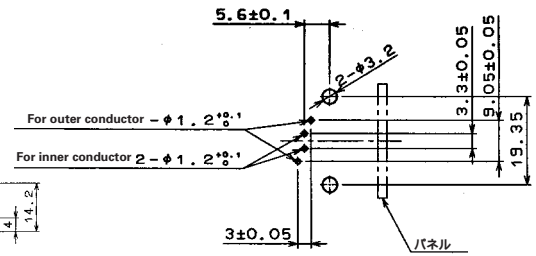

Part Number	CL No.	Material	Finish	Color
GT11-2S-HU	761-0005-1	PBT	—	Light gray
		Brass	Tin plating	—
		PBT	—	Dark gray
		Phosphor bronze	Tin plating	—

● Housing (2-position Type)

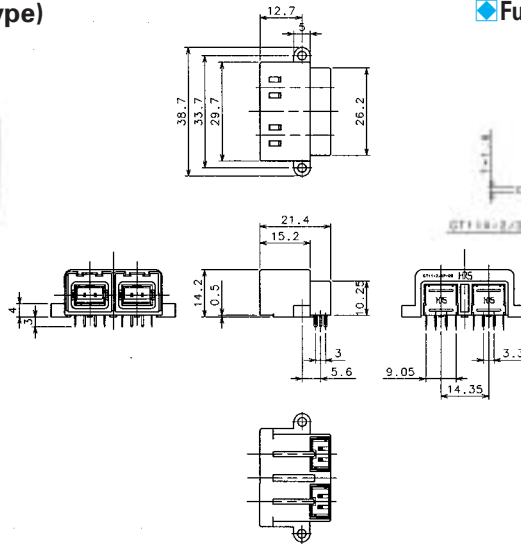

◆ Fully mated connector assemblies

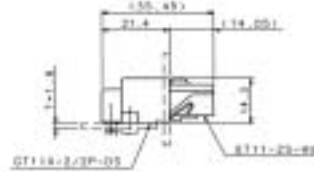

◆ Recommended Panel Cut-out



◆ Recommended Board Mounting Pattern

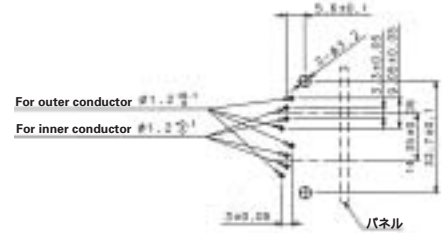

Part Number	CL No.	Material	Finish	Color
GT11X-2/2P-DS	761-0022-0	PBT	—	Light gray
		Brass	Tin plating	—
		PBT	—	Dark gray
		Phosphor bronze	Tin plating	—

● Housing (Straight Type)

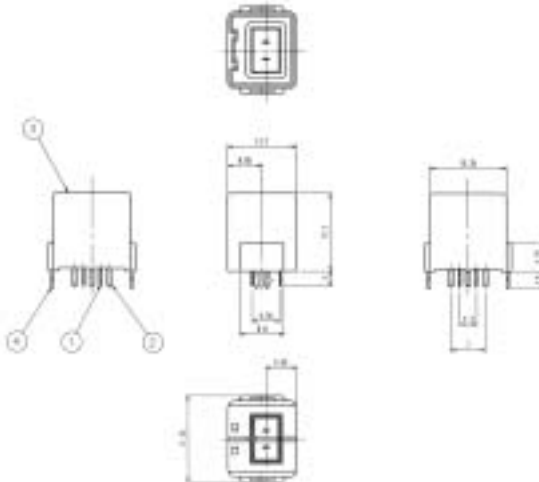

◆ Recommended Board Mounting Pattern

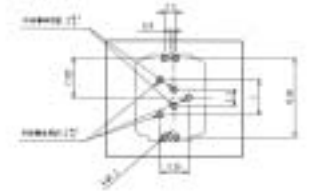

◆ Fully mated connector assemblies

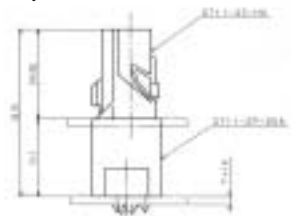

Part Number	CL No.
GT11-2P-DSA	761-0038-0

Waterproof type For Double-Conductor coaxial cable

F Connectors

● Housing

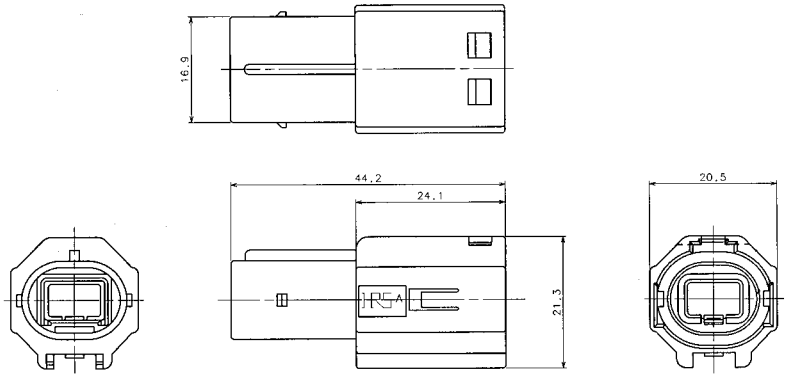

◆ Fully mated connector assemblies

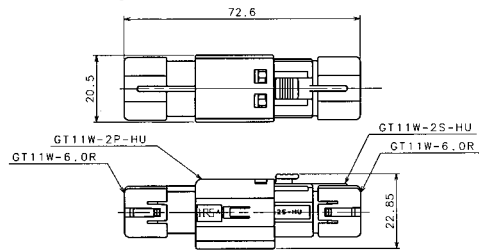

Part Number	CL No.	Material
GT11W-2P-HU	761-0023-3	PBT

M Connectors

● Housing

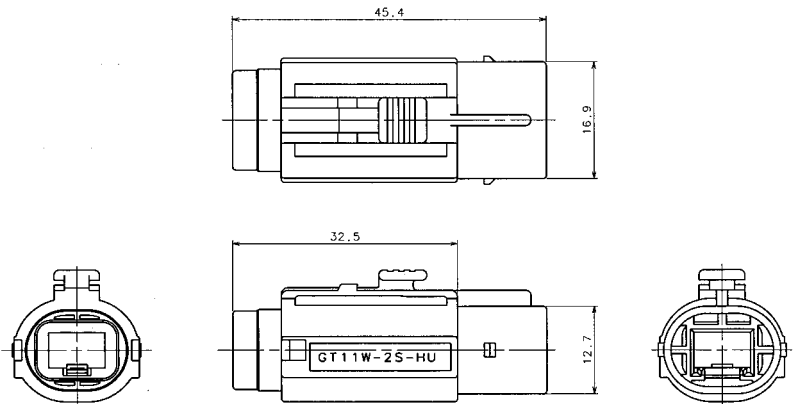

Part Number	CL No.	Material
GT11W-2S-HU	761-0024-6	PBT

● Retainer (used with GT11W-2S-HU and GT11W-2P-HU)

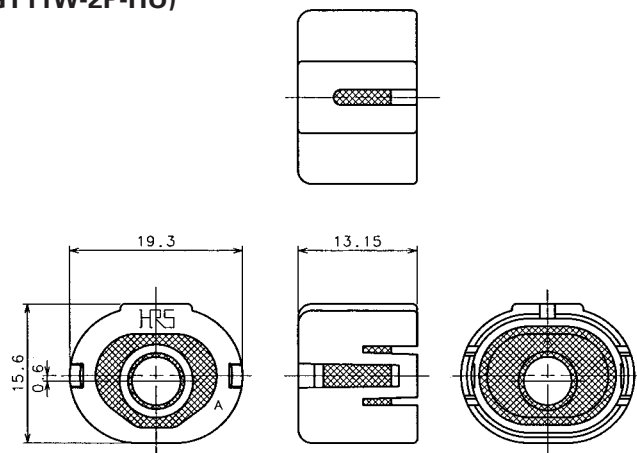

Part Number	CL No.	Applicable Cable
GT11W-6.0R	761-0025-9	PBT Silicon rubber compound

Waterproof type For Double-Conductor coaxial cable

F Connectors

● Housing

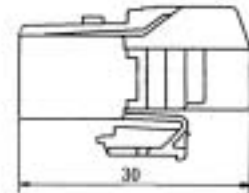
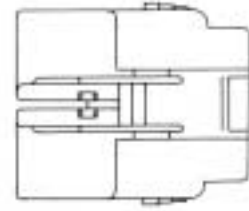
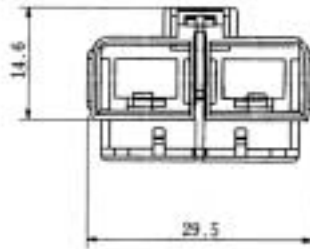

◆ Shown with inserted retainer



Part Number	CL No.	Material	Color
GT11K-2/2S-HU	761-0039-3	PBT	Light gray

* Mates only with GT11KN-2/2PP-HU.

M Connectors

● Housing

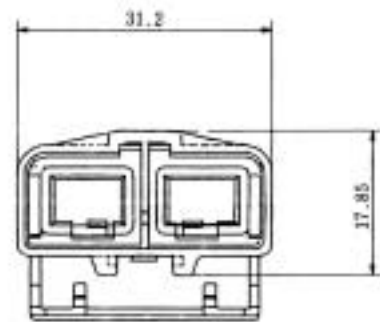
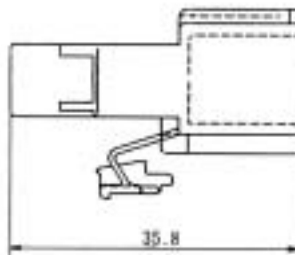
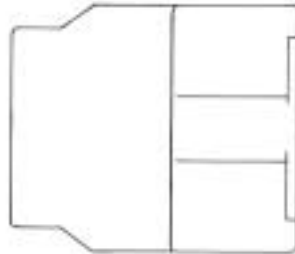

◆ Shown with inserted retainer

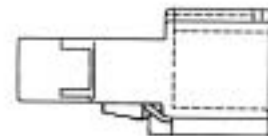

Part Number	CL No.	Material	Color
GT11KN-2/2PP-HU	761-0040-2	PBT	Light gray

◆ Termination sequence

① Strip the cable.

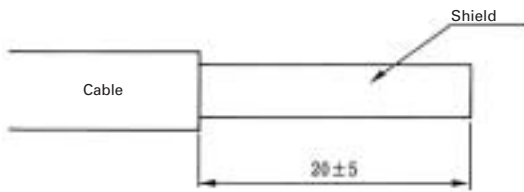

② Cut the shield and expose the wire.

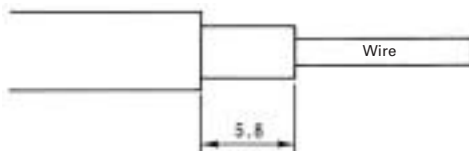

③ Cut back the shield above the sheath and wrap with conductive tape.

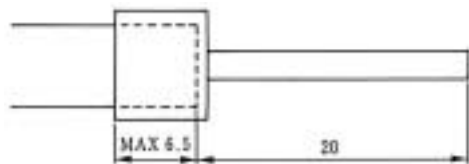

④ Strip the wire and form it.

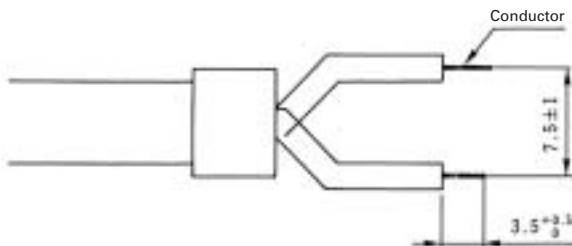

Jig used: Cable-forming strip jig
(Refer to Page 85 for detail.)

⑤ Crimp the wire to the internal terminal.

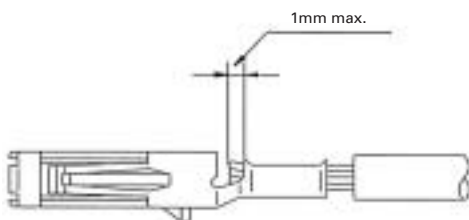

Jig used: Automatic crimping machine.
(Refer to Page 85 for detail.)

⑥ Insert the internal terminals into the Outer terminals.

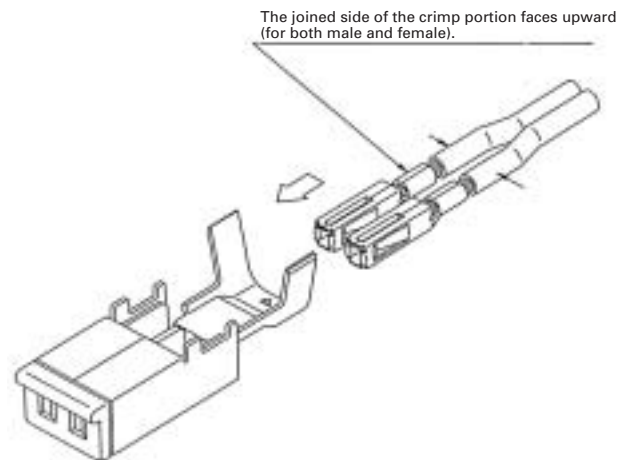

⑦ Crimp the Outer terminal.

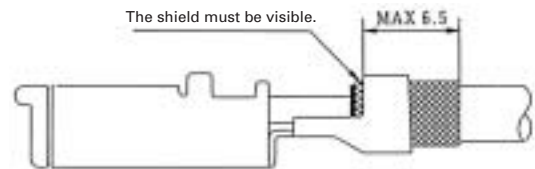

Jig used: Outside tube caulking jig.
(Refer to Page 91 for detail.)

⑧ Insert the terminal into the housing. (Please insert until the terminal is stopped by the lance.)

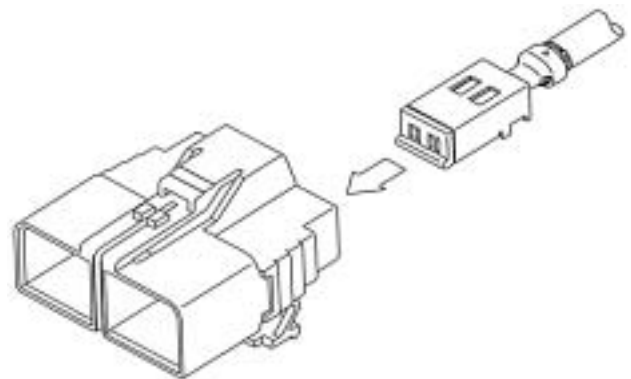

⑨ Mount the retainer to complete the task.

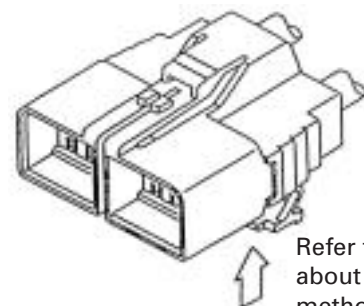

Refer to Page 84 for information about the retainer mounting method.

◆ Retainer Mounting Method

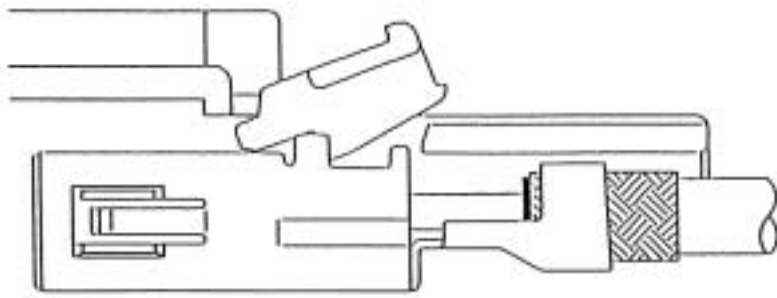
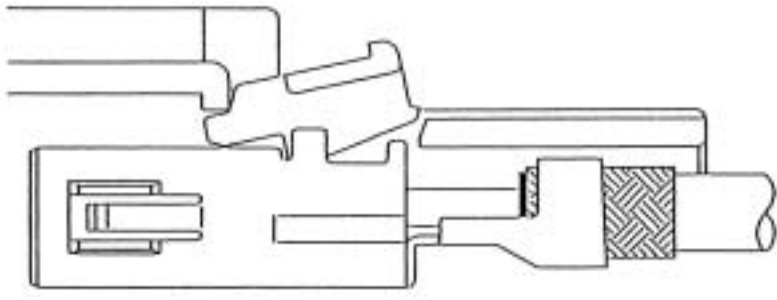
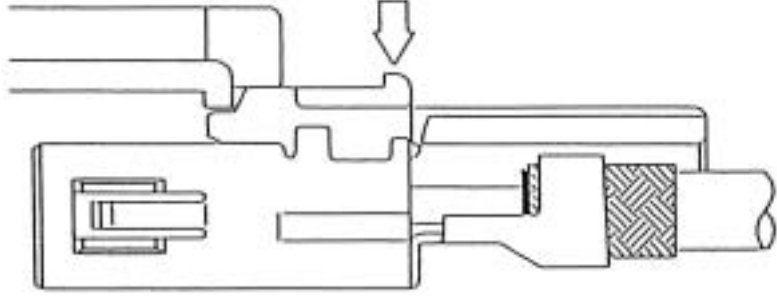
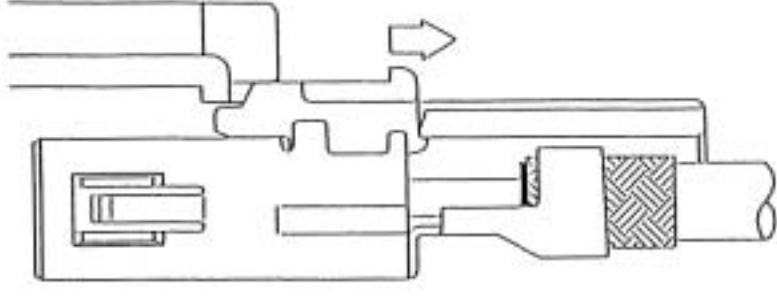
<p>a. Insert so that the terminal locking tab is inserted between the top surface of the terminal and the housing.</p>	 A cross-sectional diagram of a terminal assembly. A locking tab is being inserted from the top into a slot between the terminal and the housing. The terminal has a central pin and a side contact. The housing has a corresponding slot and a locking mechanism.
<p>b. Push in while changing the angle of the retainer until the front surface comes to a stop.</p>	 A cross-sectional diagram showing the locking tab being pushed further into the housing. The tab is now at an angle, and its front surface is in contact with the housing's internal structure.
<p>c. Press the rear portion of the retainer and snap it into the locked position.</p>	 A cross-sectional diagram showing a downward arrow pointing to the rear portion of the locking tab, indicating it is being pressed down into the housing to lock it.
<p>d. If locking is not complete, press the rear portion of the retainer again while pulling it backward.</p>	 A cross-sectional diagram showing a downward arrow on the rear portion of the tab and a rightward arrow on the front portion, indicating the final adjustment step to complete the locking process.

* Check that all locations are locked.

* Check that the bands are housed in all of the receiving areas.

◆ Termination Tools

User's manuals are available. Please ask your Hirose Electric account representative.

● Cable-Forming Strip Jig (for 2-conductor cable)

Main Unit

Accessory (Electrical Box)



Part Number CT11-ST/AD

Specifications

	Capacity	Remarks
Mounting Dimensions	Approximately 400 W x 500 D x 300 H	Approximately 300 W x 250 D x 200 H
Weight	Approximately 40 kg	Approximately 5 kg
Power supply	AC100V (50/60Hz)	
Air pressure	5-6Kgf/cm	
Task time	Approximately 14 seconds	

● Automatic Crimping Machine (for 2-conductor and 8-conductor cable)



Part Number CM-105

Specifications

Item	Specification	Remarks
Capacity	1.5tons	
Stroke	30mm	
Number of strokes	200spm (50Hz)	200spm (60Hz)
Weight	75kg	
Motor	0.2kW	AC100V
Crimping speed	2000 to 4000 pcs. per day	

● Cable-Forming Strip Jig (for 2-conductor cable)

Main Unit

Accessory (Electrical Box)



Part Number CT11-CT/AD

Specifications

	Specification	Remarks
Mounting Dimensions	Approximately 300 W x 400 D x 300 H	Approximately 300 W x 250 D x 200 H
Weight	Approximately 25 kg	Approximately 5 kg
Power supply	AC100V (50/60Hz)	
Air pressure	5-6Kgf/cm	

* Crimp height setting tables are available for each cable type. Please contact your nearest Hirose Electric account representative.
Different cables will require different crimp height settings.

For 8-Conductor coaxial shielded cable

F Connectors

● Inner Terminal

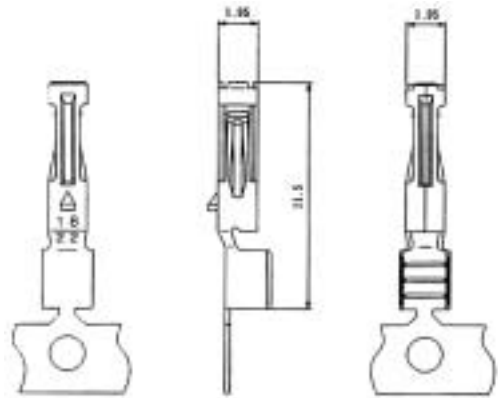

Part Number	CL No.	Conductor Size (AWG)	Material	Finish
GT11-1822SCF	761-0004-9	#24 to 28	Phosphor bronze	Tin plating
GT11-2428SCF	761-0020-5	#24 to 28	Phosphor bronze	Tin plating

● Insulator

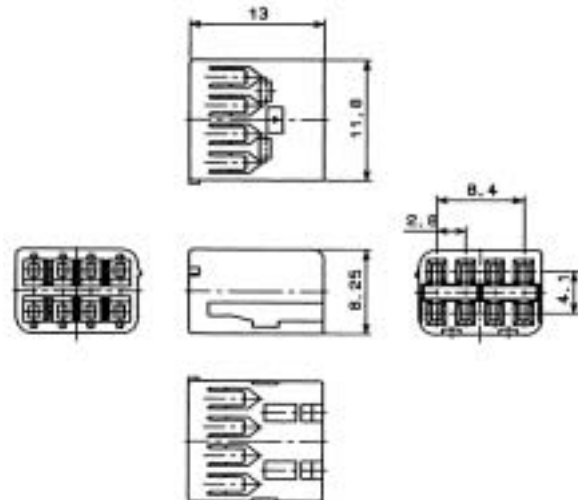

Part Number	CL No.	Material
GT11-8DS-2.8C	761-0014-2	PBT

● Outer terminals

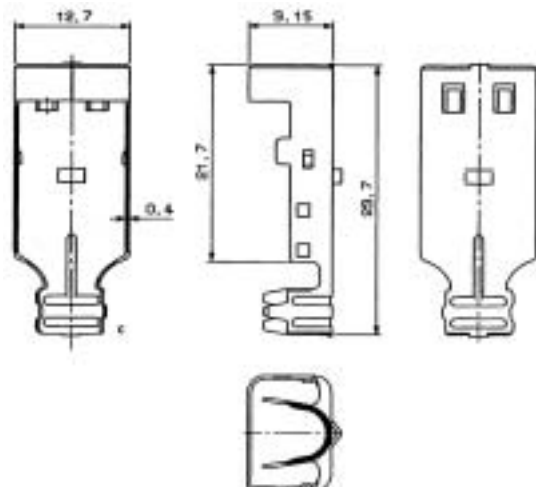

Part Number	CL No.	Material	Finish
GT11-8DS-5C	761-0015-5	Brass	Phosphor bronze

● Shield Plate

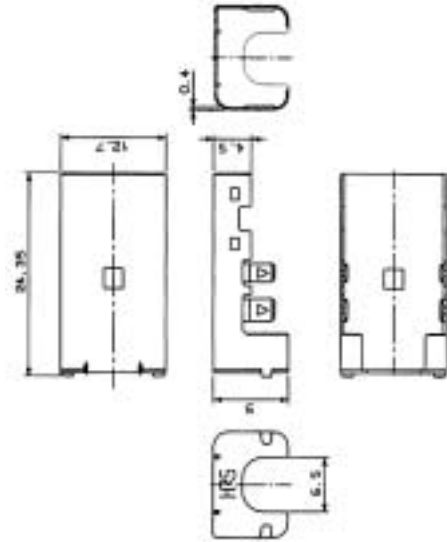

Part Number	CL No.	Material	Finish
GT11-8DS-SB	761-0016-8	Brass	Tin plating

● Housing

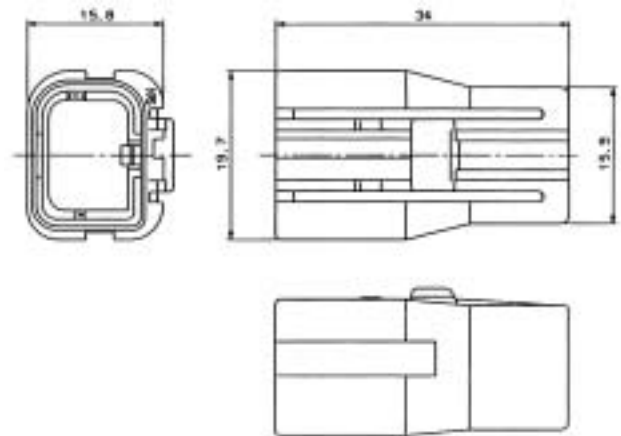

Part Number	CL No.	Material
GT11-8DS-HU	761-0017-0	PBT

● Retainer (used with GT11-8DS-HU)

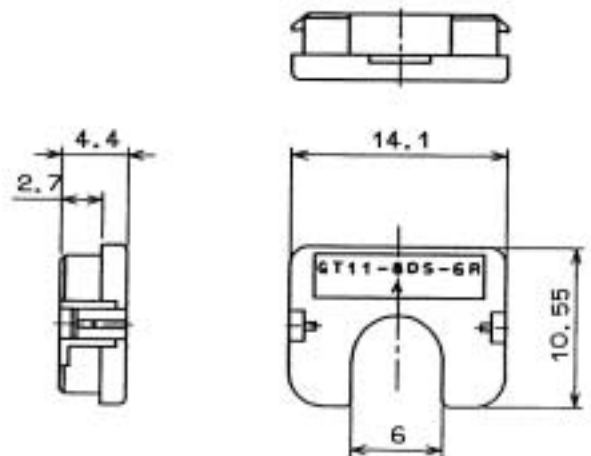

Part Number	CL No.	Material
GT11-8DS-6R	761-0018-3	PBT

M Connectors

● Inner Terminals

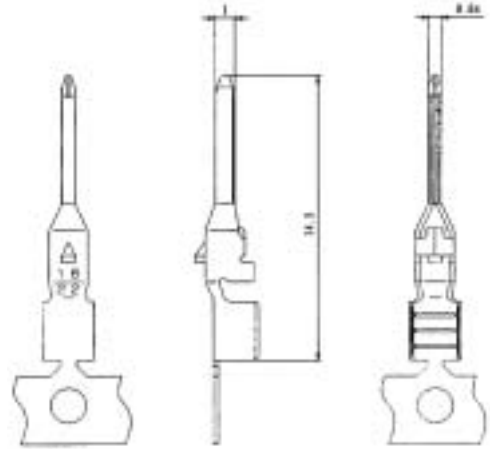

Part Number	CL No.	Conductor Size (AWG)	Material	Finish
GT11-1822PCF	761-0003-6	#18 to 22	Phosphor bronze	Tin plating
GT11-2428PCF	761-0019-6	#24 to 28	Phosphor bronze	Tin plating

● Insulator

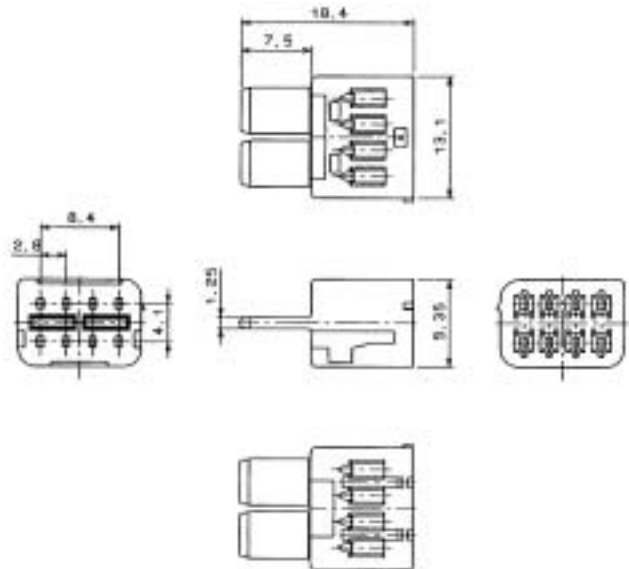

Part Number	CL No.	Material
GT11-8DP-2.8C	761-0009-2	PBT

● Outer terminals

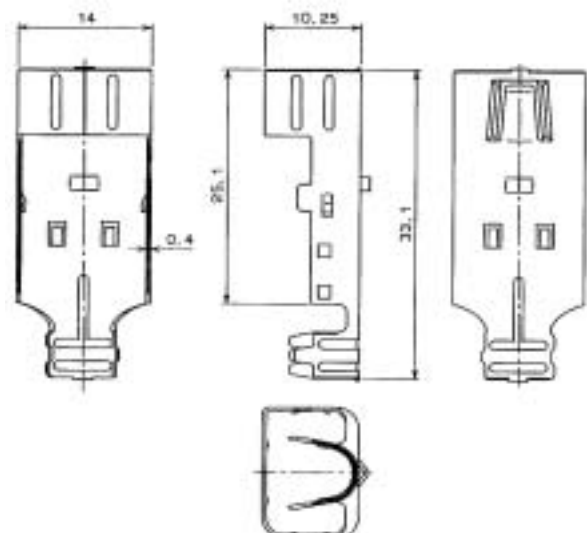

Part Number	CL No.	Material	Finish
GT11-8DP-5C	761-0010-1	Brass	Phosphor bronze

● Shield Plate

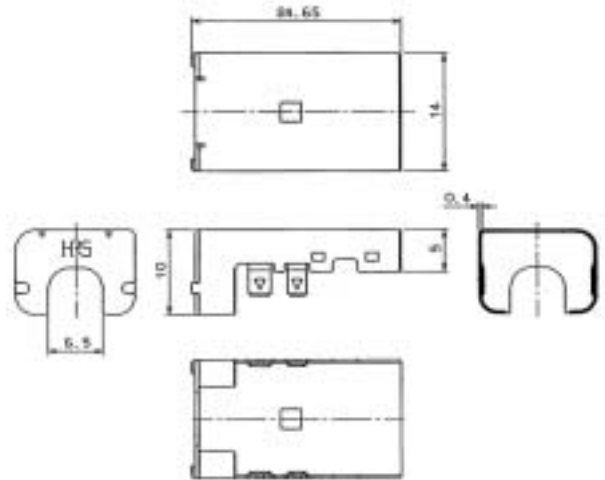

Part Number	CL No.	Material	Finish
GT11-8DP-SB	761-0011-4	Brass	Phosphor bronze

● Housing

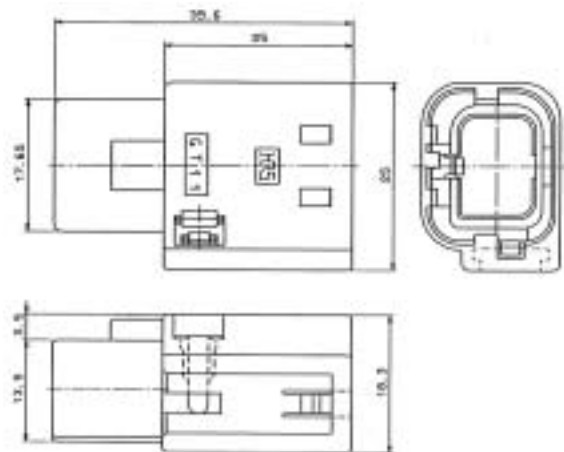

Part Number	CL No.	Material
GT11-8DP-HU	761-0012-7	PBT

● Retainer (Used with GT11-8DS-HU)

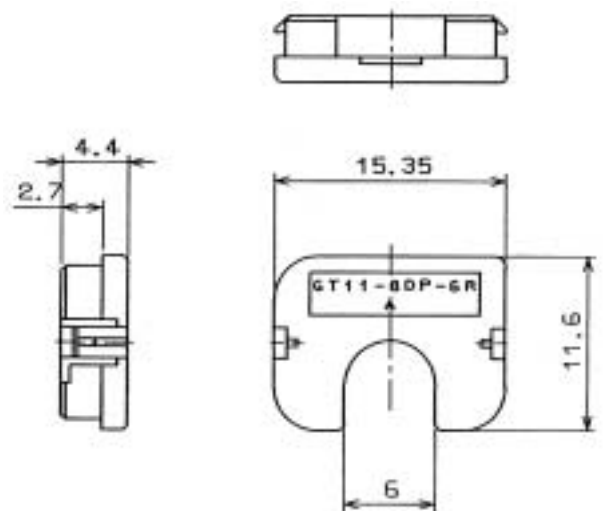

Part Number	CL No.	Material
GT11-8DP-6R	761-0013-0	PBT

* Reserved for product expansion

● Printed Circuit Board Type

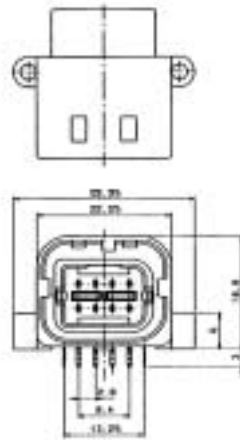
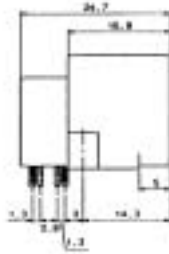

◆ Recommended Board Mounting Pattern

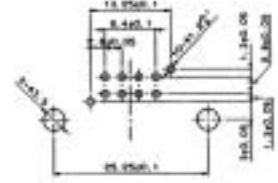

◆ Fully mated connector assemblies

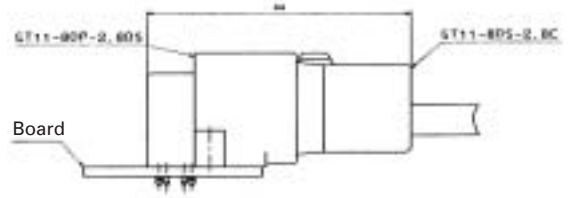

Part Number	CL No.	Item	Material	Finish
GT11-8DP-2.8DS	761-0021-8	Housing	PBT	
		Outer Terminal	Phosphor bronze	Tin plating
		Insulator	PBT	
		Terminal	Brass	Tin plating

◆ Termination sequence

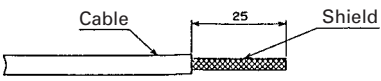
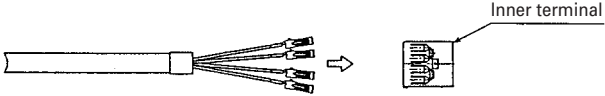
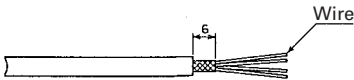
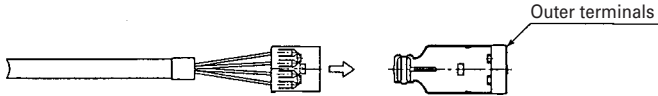
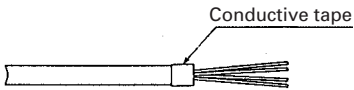
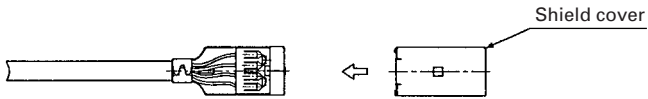
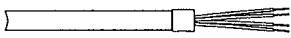
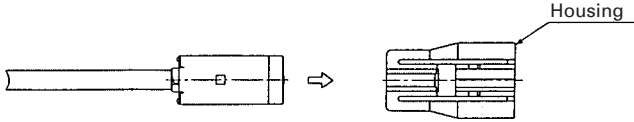
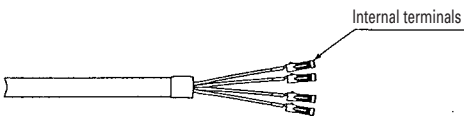
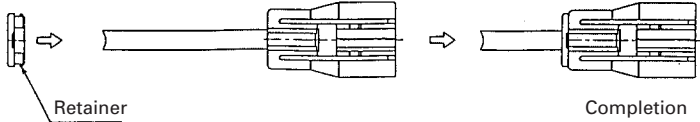
<p>① Strip the Cable.</p>  <p>The diagram shows a cross-section of a cable. A section of length 25 is marked, showing the outer jacket and the shield being stripped back. Labels include 'Cable' and 'Shield'.</p>	<p>⑥ Insert the inner terminals into the insulated case.</p>  <p>The diagram shows a bundle of wires with terminals being inserted into a rectangular insulated case. Labels include 'Inner terminal'.</p>
<p>② Cut the shield and expose the wire.</p>  <p>The diagram shows the shield being cut back, exposing the individual wires. A length of 6 is marked for the exposed wires. Labels include 'Wire'.</p>	<p>⑦ Insert what was made in Step ⑥ into the Outer terminals.</p>  <p>The diagram shows the assembly from Step 6 being inserted into a component labeled 'Outer terminals'.</p>
<p>③ Cut back the shield above the sheath and wrap with conductive tape.</p>  <p>The diagram shows the shield being wrapped with a piece of 'Conductive tape'.</p>	<p>⑧ Insert the caulking shield cover onto the Outer terminals.</p>  <p>The diagram shows a 'Shield cover' being inserted onto the assembly from Step 7.</p>
<p>④ Strip the wire.</p>  <p>The diagram shows the individual wires being stripped back.</p>	<p>⑨ Insert what was made in Step ⑧ into the housing.</p>  <p>The diagram shows the assembly from Step 8 being inserted into a component labeled 'Housing'.</p>
<p>⑤ Crimp the internal terminals.</p>  <p>The diagram shows 'Internal terminals' being crimped onto the wires.</p>	<p>⑩ Insert the retainer.</p>  <p>The diagram shows a 'Retainer' being inserted into the housing, leading to the final 'Completion' of the assembly.</p>

◆ Termination Tools

User's manuals are available. Please ask your Hirose Electric account representative.

● Cable-Forming Strip Jig (for 2-conductor cable)

Main Unit Accessory (Electrical Box)



Part Number CT11-ST/AD

Specifications

	Capacity	Remarks
Mounting Dimensions	Approximately 400 W x 500 D x 300 H	Approximately 300 W x 250 D x 200 H
Weight	Approximately 40 kg	Approximately 5 kg
Power supply	AC100V (50/60Hz)	
Air pressure	5-6Kgf/cm	
Task time	Approximately 14 seconds	

● Automatic Crimping Machine (for 2-conductor and 8-conductor cable)



Part Number CM-105

Specifications

Item	Specification	Remarks
Capacity	1.5Ton	
Stroke	30mm	
Number of strokes	200spm (50Hz)	240spm (60Hz)
Weight	75kg	
Motor	0.2kW	AC100V
Crimping speed	2000 to 4000 pcs. per day	

● Cable-Forming Strip Jig (for 2-conductor cable)

Main Unit Accessory (Electrical Box) Specifications



Part Number CT11-CT/AD

	Specification	Remarks
Mounting Dimensions	Approximately 300 W x 400 D x 300 H	Approximately 300 W x 250 D x 200 H
Weight	Approximately 25 kg	Approximately 5 kg
Power supply	AC100V (50/60Hz)	
Air pressure	5-6Kgf/cm	

* Crimp height setting tables are available for each cable type. Please contact your nearest Hirose Electric account representative.
Different cables will require different crimp height settings.

● Outer terminal Caulking Jig (for 8-conductor cable)

Hand Press



Part Number GT11-8S/P-HP

Компания «Океан Электроники» предлагает заключение долгосрочных отношений при поставках импортных электронных компонентов на взаимовыгодных условиях!

Наши преимущества:

- Поставка оригинальных импортных электронных компонентов напрямую с производств Америки, Европы и Азии, а так же с крупнейших складов мира;
- Широкая линейка поставок активных и пассивных импортных электронных компонентов (более 30 млн. наименований);
- Поставка сложных, дефицитных, либо снятых с производства позиций;
- Оперативные сроки поставки под заказ (от 5 рабочих дней);
- Экспресс доставка в любую точку России;
- Помощь Конструкторского Отдела и консультации квалифицированных инженеров;
- Техническая поддержка проекта, помощь в подборе аналогов, поставка прототипов;
- Поставка электронных компонентов под контролем ВП;
- Система менеджмента качества сертифицирована по Международному стандарту ISO 9001;
- При необходимости вся продукция военного и аэрокосмического назначения проходит испытания и сертификацию в лаборатории (по согласованию с заказчиком);
- Поставка специализированных компонентов военного и аэрокосмического уровня качества (Xilinx, Altera, Analog Devices, Intersil, Interpoint, Microsemi, Actel, Aeroflex, Peregrine, VPT, Syfer, Eurofarad, Texas Instruments, MS Kennedy, Miteq, Cobham, E2V, MA-COM, Hittite, Mini-Circuits, General Dynamics и др.);

Компания «Океан Электроники» является официальным дистрибьютором и эксклюзивным представителем в России одного из крупнейших производителей разъемов военного и аэрокосмического назначения «JONHON», а так же официальным дистрибьютором и эксклюзивным представителем в России производителя высокотехнологичных и надежных решений для передачи СВЧ сигналов «FORSTAR».



JONHON

«JONHON» (основан в 1970 г.)

Разъемы специального, военного и аэрокосмического назначения:

(Применяются в военной, авиационной, аэрокосмической, морской, железнодорожной, горно- и нефтедобывающей отраслях промышленности)

«FORSTAR» (основан в 1998 г.)

ВЧ соединители, коаксиальные кабели, кабельные сборки и микроволновые компоненты:

(Применяются в телекоммуникациях гражданского и специального назначения, в средствах связи, РЛС, а так же военной, авиационной и аэрокосмической отраслях промышленности).



Телефон: 8 (812) 309-75-97 (многоканальный)

Факс: 8 (812) 320-03-32

Электронная почта: ocean@oceanchips.ru

Web: <http://oceanchips.ru/>

Адрес: 198099, г. Санкт-Петербург, ул. Калинина, д. 2, корп. 4, лит. А