

100mW Stereo Headphone Amplifier

- Operating from **V_{cc}=2V to 5.5V**
- 100mW into 16Ω at 5V
- 38mW into 16Ω at 3.3V
- 11.5mW into 16Ω at 2V
- Switch ON/OFF click reduction circuitry
- High power supply rejection ratio: 85dB at 5V
- High signal-to-noise ratio: 110dB(A) at 5V
- High crosstalk immunity: 100dB (F=1kHz)
- Rail-to-rail input and output
- Unity-gain stable
- Available in **SO-8, MiniSO-8 & DFN8**

Description

The TS482 is a dual audio power amplifier able to drive a 16 or 32Ω stereo headset down to low voltages.

It is delivering up to 100mW per channel (into 16Ω loads) of continuous average power with 0.1% THD+N from a 5V power supply.

The unity gain stable TS482 can be configured by external gain-setting resistors.

Applications

- Stereo headphone amplifier
- Optical storage
- Computer motherboard
- PDA, organizers & notebook computers
- High-end TV, set-top box, DVD players
- Sound cards

Order Codes

Part Number	Temperature Range	Package	Packing	Marking
TS482ID/IDT	-40, +85°C	SO-8	Tube or Tape & Reel	4821
TS482IST		miniSO-8	Tape & Reel	
TS482IQT		DFN8		

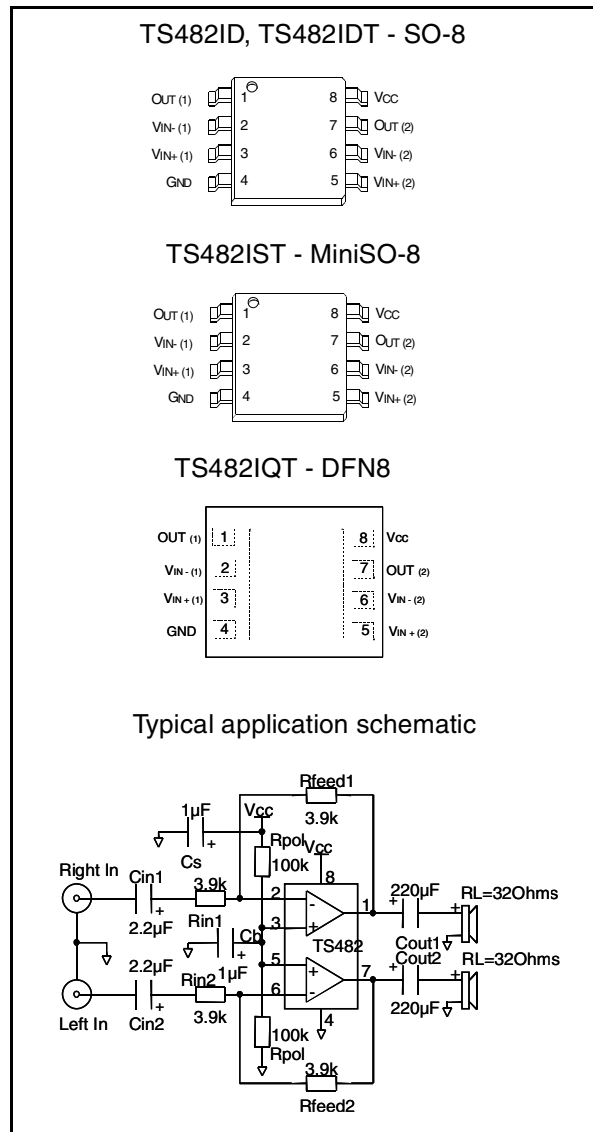

1 Absolute Maximum Ratings

Table 1. Key parameters and their absolute maximum ratings

Symbol	Parameter	Value	Unit
V _{CC}	Supply voltage ⁽¹⁾	6	V
V _i	Input Voltage	-0.3 to V _{CC} +0.3	V
T _{oper}	Operating Free Air Temperature Range	-40 to + 85	°C
T _{stg}	Storage Temperature	-65 to +150	°C
T _j	Maximum Junction Temperature	150	°C
R _{thja}	Thermal Resistance Junction to Ambient SO8 MiniSO8 DFN8	175 215 70	°C/W
Pd	Power Dissipation ⁽²⁾ SO-8 MiniSO-8 DFN8	0.71 0.58 1.79	W
ESD	Human Body Model (pin to pin)	2	kV
ESD	Machine Model - 220pF - 240pF (pin to pin)	200	V
Latch-up	Latch-up Immunity (all pins)	200	mA
	Lead Temperature (soldering, 10sec)	250	°C
	Lead Temperature (soldering, 10sec) for lead-free	260	°C
	Output Short-Circuit Duration	see note ⁽³⁾	

1. All voltages values are measured with respect to the ground pin.
2. Pd has been calculated with Tamb = 25°C, Tjunction = 150°C.
3. Attention must be paid to continuous power dissipation. Exposure of the IC to a short circuit on one or two amplifiers simultaneously can cause excessive heating and the destruction of the device.

Table 2. Operating conditions

Symbol	Parameter	Value	Unit
V _{CC}	Supply Voltage	2 to 5.5	V
R _L	Load Resistor	>= 16	Ω
C _L	Load Capacitor R _L = 16 to 100Ω R _L > 100Ω	400 100	pF
V _{icm}	Common Mode Input Voltage Range	G _{ND} to V _{CC}	V
R _{thja}	Thermal Resistance Junction to Ambient SO-8 MiniSO-8 DFN8 ⁽¹⁾	150 190 41	°C/W

1. When mounted on a 4-layer PCB.

2 Electrical Characteristics

Table 3. Electrical characteristics when $V_{CC} = +5V$, $GND = 0V$, $T_{amb} = 25^{\circ}C$ (unless otherwise specified)

Symbol	Parameter	Min.	Typ.	Max.	Unit
I_{CC}	Supply Current No input signal, no load		5.5	7.2	mA
V_{IO}	Input Offset Voltage ($V_{ICM} = V_{CC}/2$)		1	5	mV
I_{IB}	Input Bias Current ($V_{ICM} = V_{CC}/2$)		200	500	nA
P_O	Output Power THD+N = 0.1% Max, F = 1kHz, $R_L = 32\Omega$ THD+N = 1% Max, F = 1kHz, $R_L = 32\Omega$ THD+N = 0.1% Max, F = 1kHz, $R_L = 16\Omega$ THD+N = 1% Max, F = 1kHz, $R_L = 16\Omega$	60 95	65 67.5 100 107		mW
THD + N	Total Harmonic Distortion + Noise ($A_v=-1$) ⁽¹⁾ $R_L = 32\Omega$, $P_{out} = 60mW$, $20Hz \leq F \leq 20kHz$ $R_L = 16\Omega$, $P_{out} = 90mW$, $20Hz \leq F \leq 20kHz$		0.03 0.03		%
PSRR	Power Supply Rejection Ratio ($A_v=1$), inputs floating F = 100Hz, Vripple = 100mVpp		85		dB
I_O	Max Output Current THD +N < 1%, $R_L = 16\Omega$ connected between out and $V_{CC}/2$	106	120		mA
V_O	Output Swing V_{OL} : $R_L = 32\Omega$ V_{OH} : $R_L = 32\Omega$ V_{OL} : $R_L = 16\Omega$ V_{OH} : $R_L = 16\Omega$	4.45 4.2	0.4 4.6 0.55 4.4	0.48 0.65	V
SNR	Signal-to-Noise Ratio (Filter Type A, $A_v=-1$) $R_L = 32\Omega$, THD +N < 0.2%, $20Hz \leq F \leq 20kHz$	95	110		dB
Crosstalk	Channel Separation, $R_L = 32\Omega$ F = 1kHz F = 20Hz to 20kHz Channel Separation, $R_L = 16\Omega$ F = 1kHz F = 20Hz to 20kHz		100 80 100 80		dB
C_I	Input Capacitance		1		pF
GBP	Gain Bandwidth Product ($R_L = 32\Omega$)	1.35	2.2		MHz
SR	Slew Rate, Unity Gain Inverting ($R_L = 16\Omega$)	0.45	0.7		V/ μ s

1. Fig. 68 to 79 show dispersion of these parameters.

Table 4. Electrical characteristics when $V_{CC} = +3.3V$, $GND = 0V$, $T_{amb} = 25^{\circ}C$ (unless otherwise specified) ⁽¹⁾

Symbol	Parameter	Min.	Typ.	Max.	Unit
I_{CC}	Supply Current No input signal, no load		5.3	7.2	mA
V_{IO}	Input Offset Voltage ($V_{ICM} = V_{CC}/2$)		1	5	mV
I_{IB}	Input Bias Current ($V_{ICM} = V_{CC}/2$)		200	500	nA
P_O	Output Power THD+N = 0.1% Max, F = 1kHz, $R_L = 32\Omega$ THD+N = 1% Max, F = 1kHz, $R_L = 32\Omega$ THD+N = 0.1% Max, F = 1kHz, $R_L = 16\Omega$ THD+N = 1% Max, F = 1kHz, $R_L = 16\Omega$	23	27 28 38 42		mW
THD + N	Total Harmonic Distortion + Noise ($A_v=-1$) ⁽¹⁾ $R_L = 32\Omega$, $P_{out} = 16mW$, $20Hz \leq F \leq 20kHz$ $R_L = 16\Omega$, $P_{out} = 35mW$, $20Hz \leq F \leq 20kHz$		0.03 0.03		%
PSRR	Power Supply Rejection Ratio ($A_v=1$), inputs floating F = 100Hz, Vripple = 100mVpp		80		dB
I_O	Max Output Current THD +N < 1%, $R_L = 16\Omega$ connected between out and $V_{CC}/2$	64	75		mA
V_O	Output Swing V_{OL} : $R_L = 32\Omega$ V_{OH} : $R_L = 32\Omega$ V_{OL} : $R_L = 16\Omega$ V_{OH} : $R_L = 16\Omega$	2.85 2.68	0.3 3 0.45 2.85	0.38 0.52	V
SNR	Signal-to-Noise Ratio (Filter Type A, $A_v=-1$) $R_L = 32\Omega$, THD +N < 0.2%, $20Hz \leq F \leq 20kHz$	92	107		dB
Crosstalk	Channel Separation, $R_L = 32\Omega$ F = 1kHz F = 20Hz to 20kHz Channel Separation, $R_L = 16\Omega$ F = 1kHz F = 20Hz to 20kHz		100 80 100 80		dB
C_I	Input Capacitance		1		pF
GBP	Gain Bandwidth Product ($R_L = 32\Omega$)	1.2	2		MHz
SR	Slew Rate, Unity Gain Inverting ($R_L = 16\Omega$)	0.45	0.7		V/ μ s

1. Fig. 68 to 79 show dispersion of these parameters.

1. All electrical values are guaranteed with correlation measurements at 2V and 5V.

Table 5. Electrical characteristics when $V_{CC} = +2.5V$, $GND = 0V$, $T_{amb} = 25^{\circ}C$ (unless otherwise specified)⁽²⁾

Symbol	Parameter	Min.	Typ.	Max.	Unit
I_{CC}	Supply Current No input signal, no load		5.1	7.2	mA
V_{IO}	Input Offset Voltage ($V_{ICM} = V_{CC}/2$)		1	5	mV
I_{IB}	Input Bias Current ($V_{ICM} = V_{CC}/2$)		200	500	nA
P_O	Output Power THD+N = 0.1% Max, F = 1kHz, $R_L = 32\Omega$ THD+N = 1% Max, F = 1kHz, $R_L = 32\Omega$ THD+N = 0.1% Max, F = 1kHz, $R_L = 16\Omega$ THD+N = 1% Max, F = 1kHz, $R_L = 16\Omega$	12.5 17.5	13.5 14.5 20.5 22		mW
THD + N	Total Harmonic Distortion + Noise ($A_V = -1$) ⁽¹⁾ $R_L = 32\Omega$, $P_{out} = 10mW$, $20Hz \leq F \leq 20kHz$ $R_L = 16\Omega$, $P_{out} = 16mW$, $20Hz \leq F \leq 20kHz$		0.03 0.03		%
PSRR	Power Supply Rejection Ratio ($A_V = 1$), inputs floating F = 100Hz, Vripple = 100mVpp		75		dB
I_O	Max Output Current THD + N < 1%, $R_L = 16\Omega$ connected between out and $V_{CC}/2$	45	56		mA
V_O	Output Swing V_{OL} : $R_L = 32\Omega$ V_{OH} : $R_L = 32\Omega$ V_{OL} : $R_L = 16\Omega$ V_{OH} : $R_L = 16\Omega$	2.14 1.97	0.25 2.25 0.35 2.15	0.325 0.45	V
SNR	Signal-to-Noise Ratio (Filter Type A, $A_V = -1$) $R_L = 32\Omega$, THD + N < 0.2%, $20Hz \leq F \leq 20kHz$	89	102		dB
Crosstalk	Channel Separation, $R_L = 32\Omega$ F = 1kHz F = 20Hz to 20kHz Channel Separation, $R_L = 16\Omega$ F = 1kHz F = 20Hz to 20kHz		100 80 100 80		dB
C_I	Input Capacitance		1		pF
GBP	Gain Bandwidth Product ($R_L = 32\Omega$)	1.2	2		MHz
SR	Slew Rate, Unity Gain Inverting ($R_L = 16\Omega$)	0.45	0.7		V/ μ s

1. Fig. 68 to 79 show dispersion of these parameters.

2. All electrical values are guaranteed with correlation measurements at 2V and 5V.

Table 6. Electrical characteristics when $V_{CC} = +2V$, $GND = 0V$, $T_{amb} = 25^{\circ}C$ (unless otherwise specified)

Symbol	Parameter	Min.	Typ.	Max.	Unit
I_{CC}	Supply Current No input signal, no load		5	7.2	mA
V_{IO}	Input Offset Voltage ($V_{ICM} = V_{CC}/2$)		1	5	mV
I_{IB}	Input Bias Current ($V_{ICM} = V_{CC}/2$)		200	500	nA
P_O	Output Power THD+N = 0.1% Max, F = 1kHz, $R_L = 32\Omega$ THD+N = 1% Max, F = 1kHz, $R_L = 32\Omega$ THD+N = 0.1% Max, F = 1kHz, $R_L = 16\Omega$ THD+N = 1% Max, F = 1kHz, $R_L = 16\Omega$	7 9.5	8 9 11.5 13		mW
THD + N	Total Harmonic Distortion + Noise ($A_v=-1$) ⁽¹⁾ $R_L = 32\Omega$, $P_{out} = 6.5mW$, $20Hz \leq F \leq 20kHz$ $R_L = 16\Omega$, $P_{out} = 8mW$, $20Hz \leq F \leq 20kHz$		0.02 0.025		%
PSRR	Power Supply Rejection Ratio ($A_v=1$), inputs floating F = 100Hz, Vripple = 100mVpp		75		dB
I_O	Max Output Current THD +N < 1%, $R_L = 16\Omega$ connected between out and $V_{CC}/2$	33	41.5		mA
V_O	Output Swing V_{OL} : $R_L = 32\Omega$ V_{OH} : $R_L = 32\Omega$ V_{OL} : $R_L = 16\Omega$ V_{OH} : $R_L = 16\Omega$	1.67 1.53	0.24 1.73 0.33 1.63	0.295 0.41	V
SNR	Signal-to-Noise Ratio (Filter Type A, $A_v=-1$) $R_L = 32\Omega$, THD +N < 0.2%, $20Hz \leq F \leq 20kHz$	88	101		dB
Crosstalk	Channel Separation, $R_L = 32\Omega$ F = 1kHz F = 20Hz to 20kHz Channel Separation, $R_L = 16\Omega$ F = 1kHz F = 20Hz to 20kHz		100 80 100 80		dB
C_I	Input Capacitance		1		pF
GBP	Gain Bandwidth Product ($R_L = 32\Omega$)	1.2	2		MHz
SR	Slew Rate, Unity Gain Inverting ($R_L = 16\Omega$)	0.42	0.65		V/ μ s

1. Fig. 68 to 79 show dispersion of these parameters.

Table 7. Components description

Components	Functional Description
Rin	Inverting input resistor which sets the closed loop gain in conjunction with Rfeed. This resistor also forms a high pass filter with Cin ($f_c = 1 / (2 \times \pi \times R_{in} \times C_{in})$)
Cin	Input coupling capacitor which blocks the DC voltage at the amplifier input terminal
Rfeed	Feed back resistor which sets the closed loop gain in conjunction with Rin
Cs	Supply Bypass capacitor which provides power supply filtering
Cb	Bypass capacitor which provides half supply filtering
Cout	Output coupling capacitor which blocks the DC voltage at the load input terminal This capacitor also forms a high pass filter with RL ($f_c = 1 / (2 \times \pi \times R_L \times C_{out})$)
Rpol	These 2 resistors form a voltage divider which provide a DC biasing voltage ($V_{cc}/2$) for the 2 amplifiers.
Av	Closed loop gain = $-R_{feed} / R_{in}$

Table 8. Index of graphics

Description	Figure	Page
<i>Open loop gain and phase vs. frequency response</i>	<i>Figure 1 to 10</i>	<i>Page 9 to 10</i>
<i>Phase and Gain Margin vs. Power Supply Voltage</i>	<i>Figure 11 to 20</i>	<i>Page 10 to 12</i>
<i>Output power vs. power supply voltage</i>	<i>Figure 21 to 23</i>	<i>Page 12</i>
<i>Output power vs. load resistance</i>	<i>Figure 24 to 27</i>	<i>Page 12 to 13</i>
<i>Power dissipation vs. output power</i>	<i>Figure 28 to 31</i>	<i>Page 13 to 14</i>
<i>Power derating vs. ambient temperature</i>	<i>Figure 32</i>	<i>Page 14</i>
<i>Current consumption vs. power supply voltage</i>	<i>Figure 33</i>	<i>Page 14</i>
<i>Power supply rejection ratio vs. frequency</i>	<i>Figure 34</i>	<i>Page 14</i>
<i>THD + N vs. output power</i>	<i>Figure 35 to 49</i>	<i>Page 14 to 17</i>
<i>THD + N vs. frequency</i>	<i>Figure 50 to 54</i>	<i>Page 17</i>
<i>Signal to noise ratio</i>	<i>Figure 55 to 58</i>	<i>Page 18</i>
<i>Equivalent input noise voltage vs. frequency</i>	<i>Figure 59</i>	<i>Page 18</i>
<i>Output voltage swing vs. power supply</i>	<i>Figure 60</i>	<i>Page 18</i>
<i>Crosstalk vs. frequency</i>	<i>Figure 61 to 65</i>	<i>Page 19</i>
<i>Lower cut off frequency vs. output capacitor</i>	<i>Figure 66</i>	<i>Page 19</i>
<i>Lower cut off frequency vs. input capacitor</i>	<i>Figure 67</i>	<i>Page 20</i>
<i>Typical distribution of TDH + N</i>	<i>Figure 68 to 79</i>	<i>Page 20 to 22</i>

Figure 1. Open loop gain and phase vs. frequency response

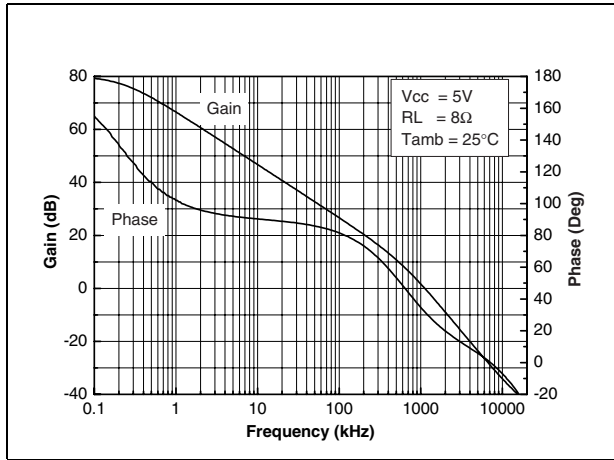

Figure 2. Open loop gain and phase vs. frequency response

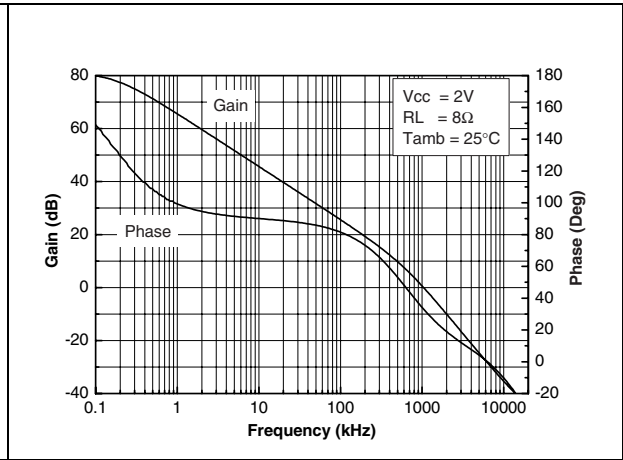

Figure 3. Open loop gain and phase vs. frequency response

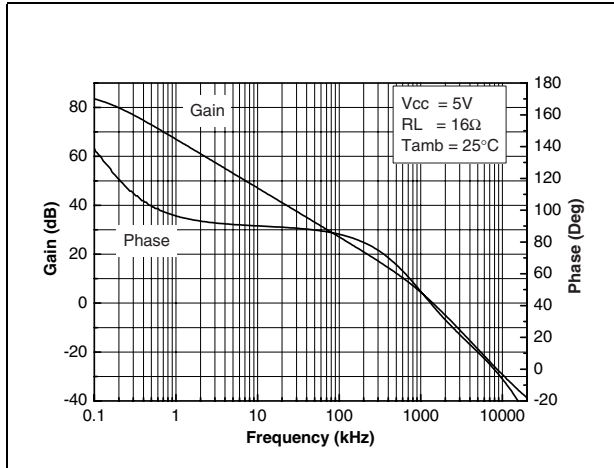

Figure 4. Open loop gain and phase vs. frequency response

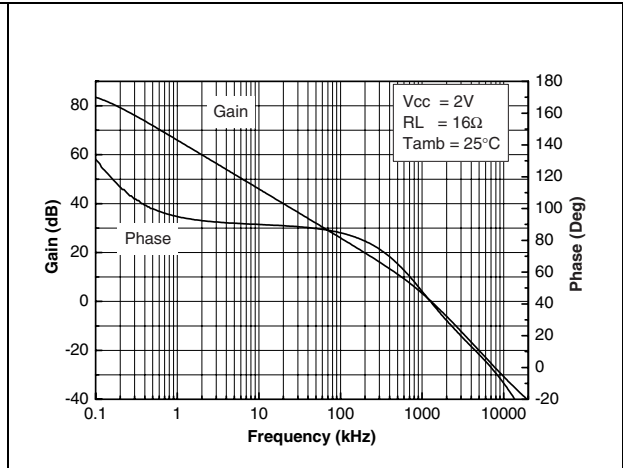

Figure 5. Open loop gain and phase vs. frequency response

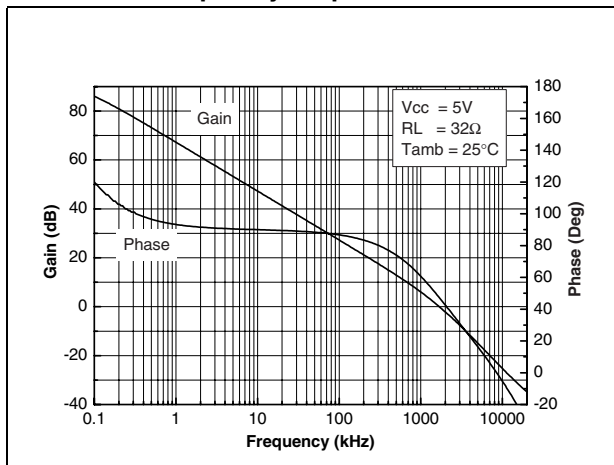

Figure 6. Open loop gain and phase vs. frequency response

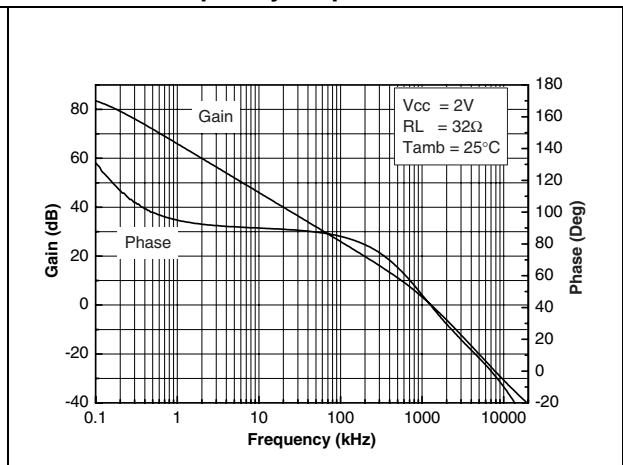

Figure 7. Open loop gain and phase vs. frequency response

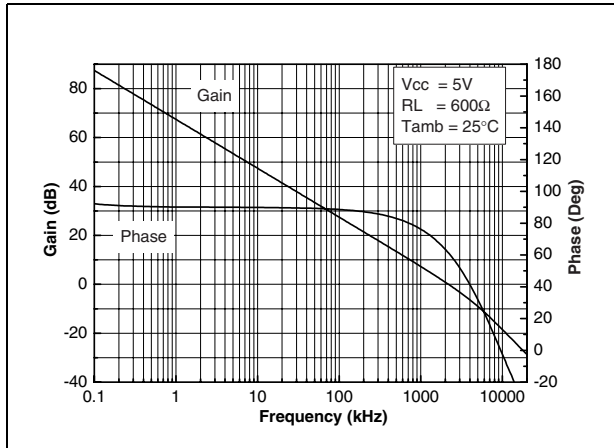

Figure 8. Open loop gain and phase vs. frequency response

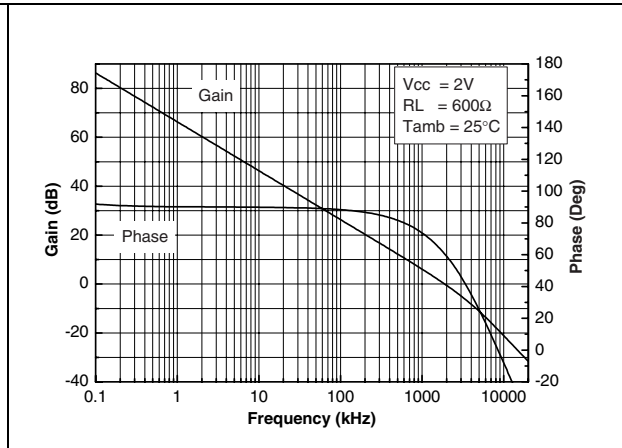

Figure 9. Open loop gain and phase vs. frequency response

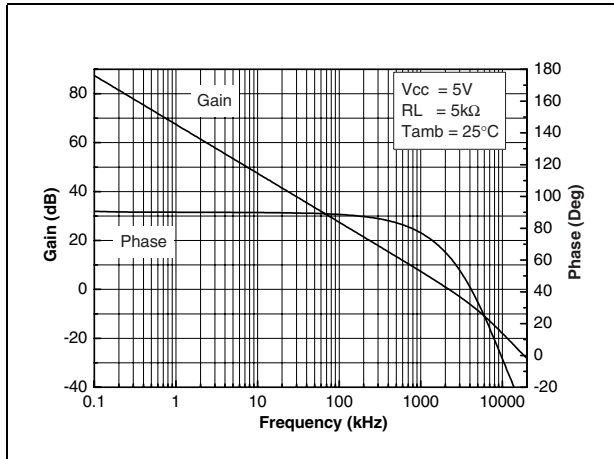

Figure 10. Open loop gain and phase vs. frequency response

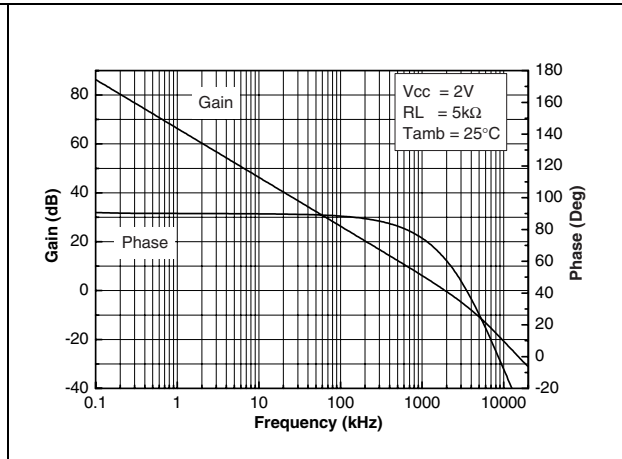

Figure 11. Phase margin vs. power supply voltage Figure 12. Phase margin vs. power supply voltage

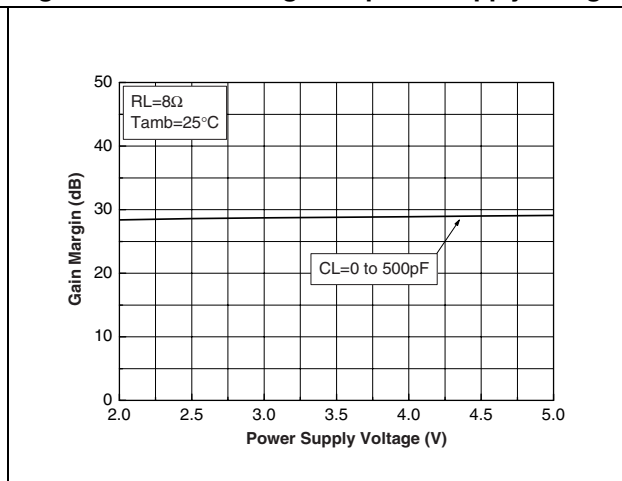
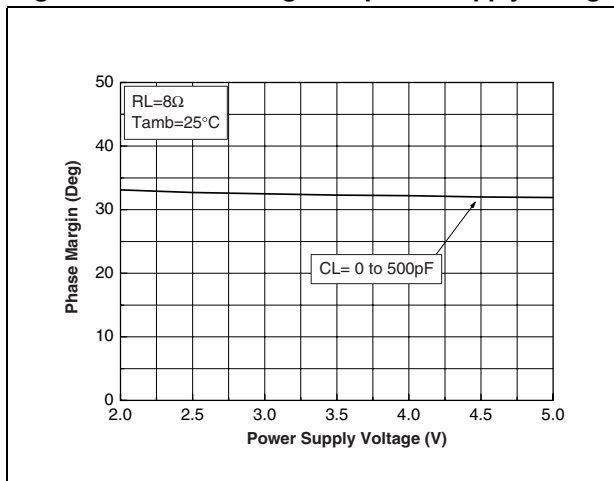

Figure 13. Phase margin vs. power supply voltage Figure 14. Gain margin vs. power supply voltage

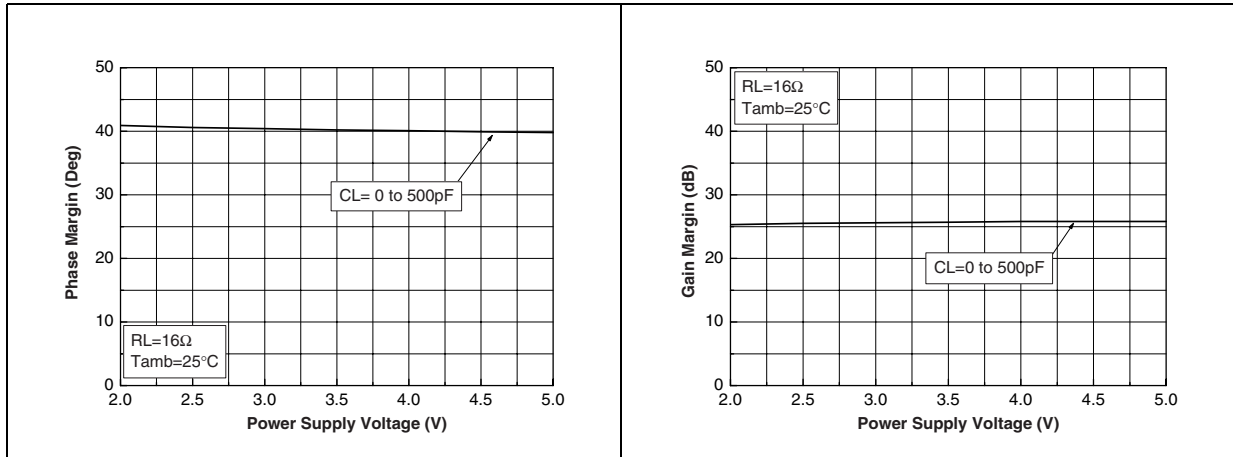

Figure 15. Phase margin vs. power supply voltage Figure 16. Gain margin vs. power supply voltage

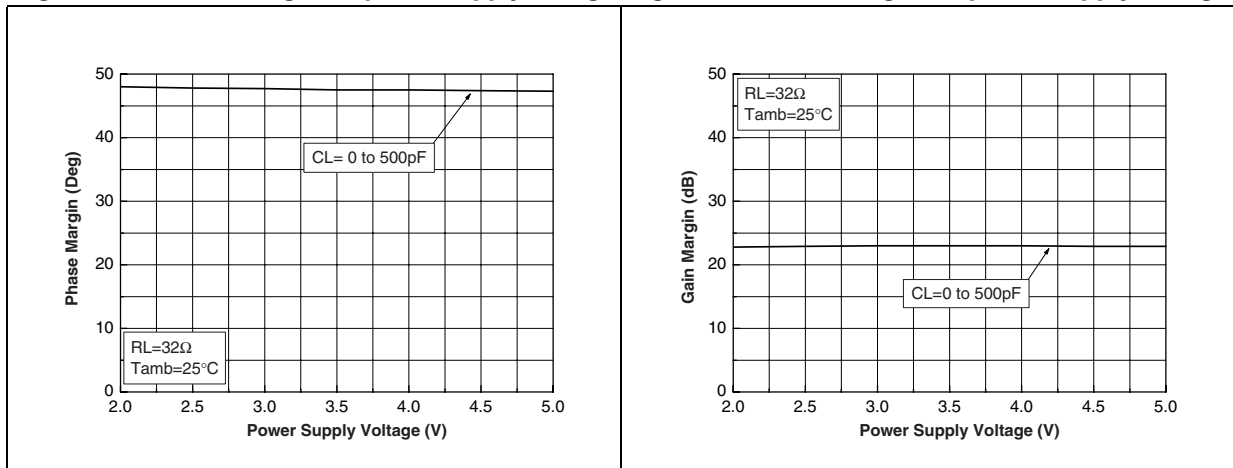

Figure 17. Phase margin vs. power supply voltage Figure 18. Gain margin vs. power supply voltage

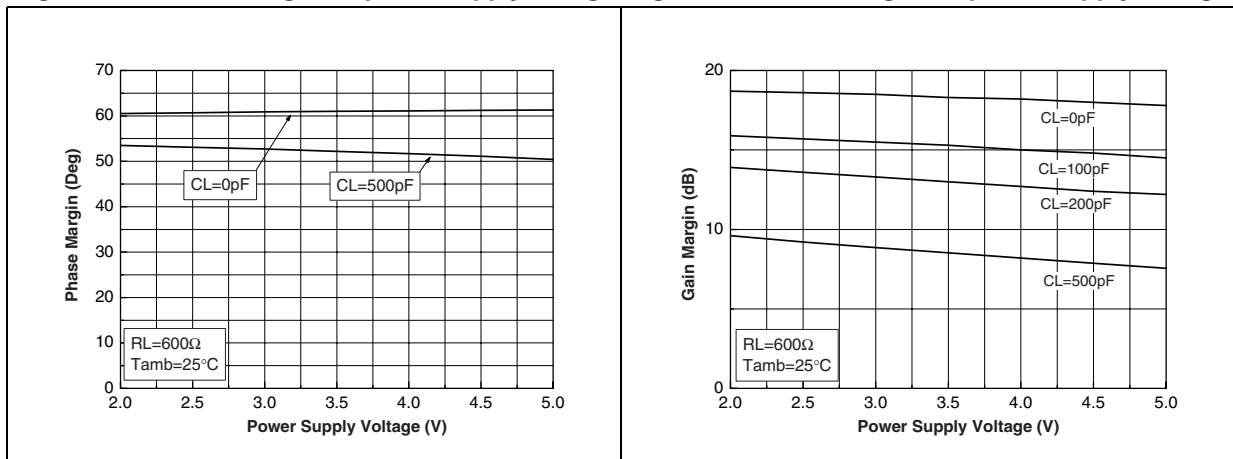

Figure 19. Phase margin vs. power supply voltage Figure 20. Gain margin vs. power supply voltage

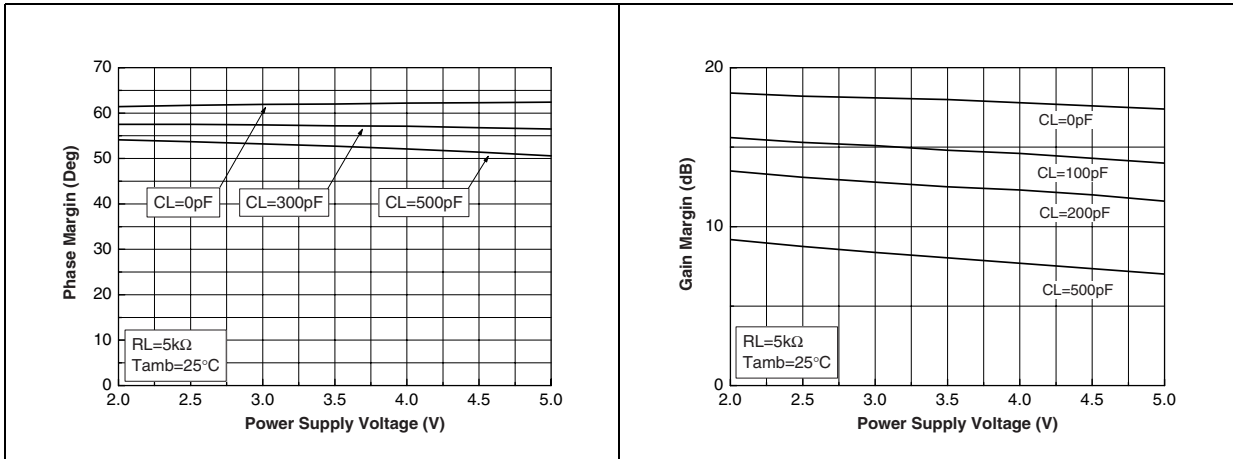

Figure 21. Output power vs. power supply voltage Figure 22. Output power vs. power supply voltage

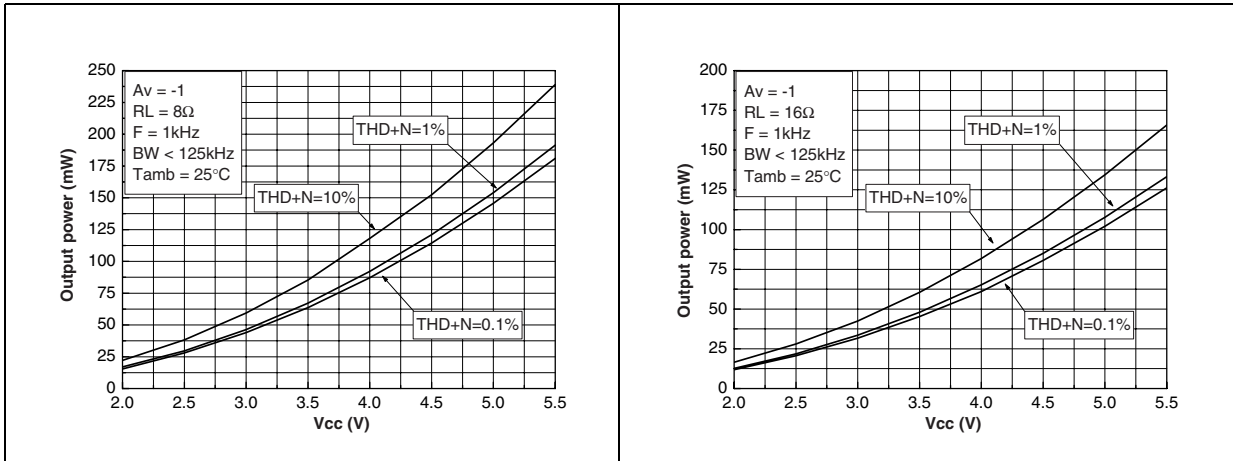

Figure 23. Output power vs. power supply voltage Figure 24. Output power vs. load resistance

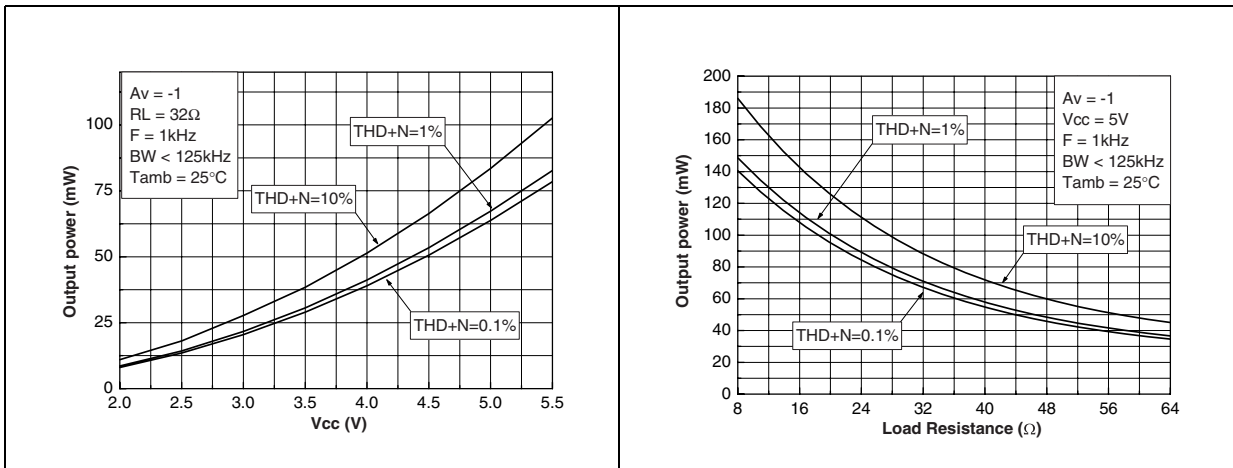

Figure 25. Output power vs. load resistance

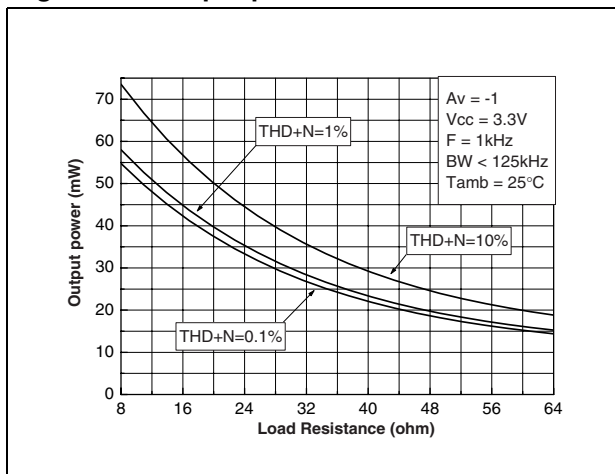

Figure 26. Output power vs. load resistance

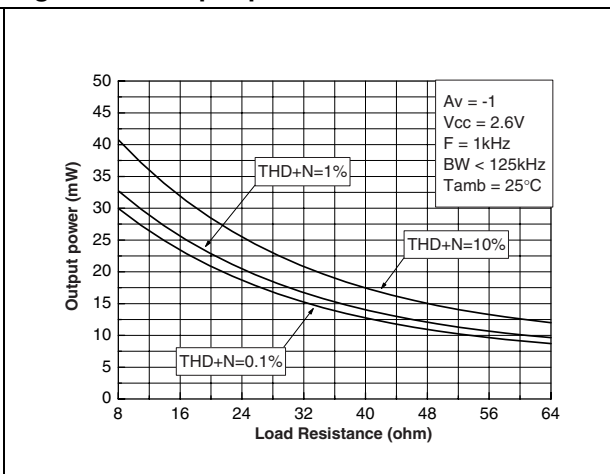

Figure 27. Output power vs. load resistance

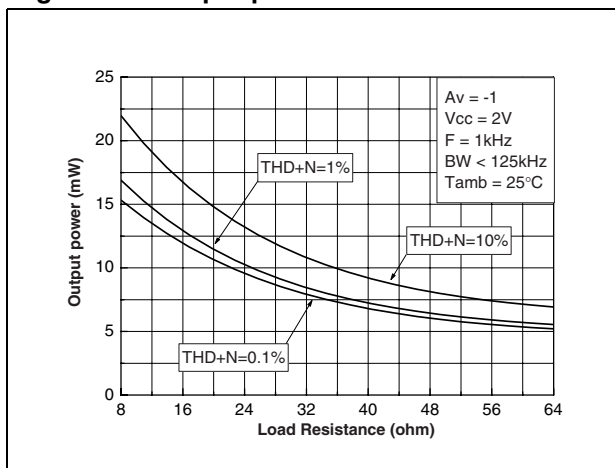

Figure 28. Power dissipation vs. output power

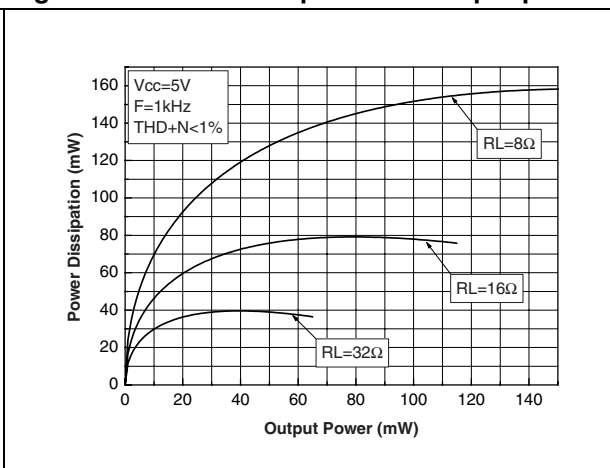

Figure 29. Power dissipation vs. output power

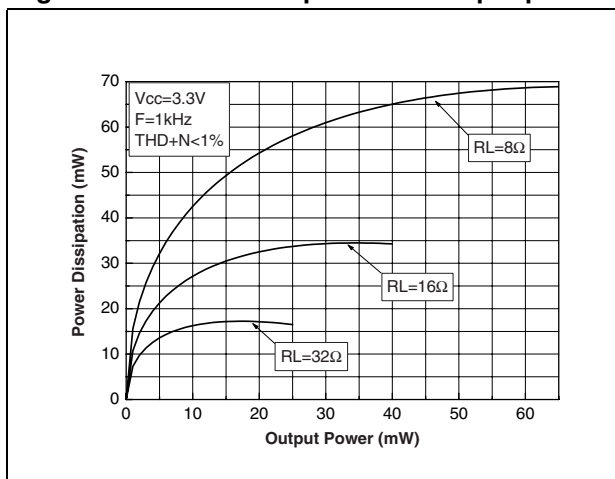

Figure 30. Power dissipation vs. output power

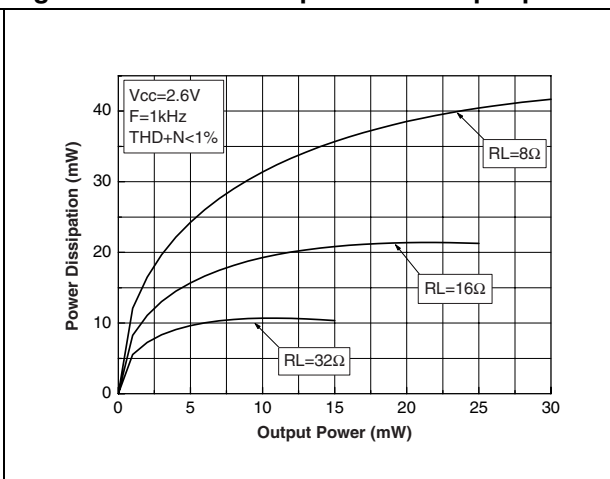

Figure 31. Power dissipation vs. output power Figure 32. Power derating vs. ambient temperature

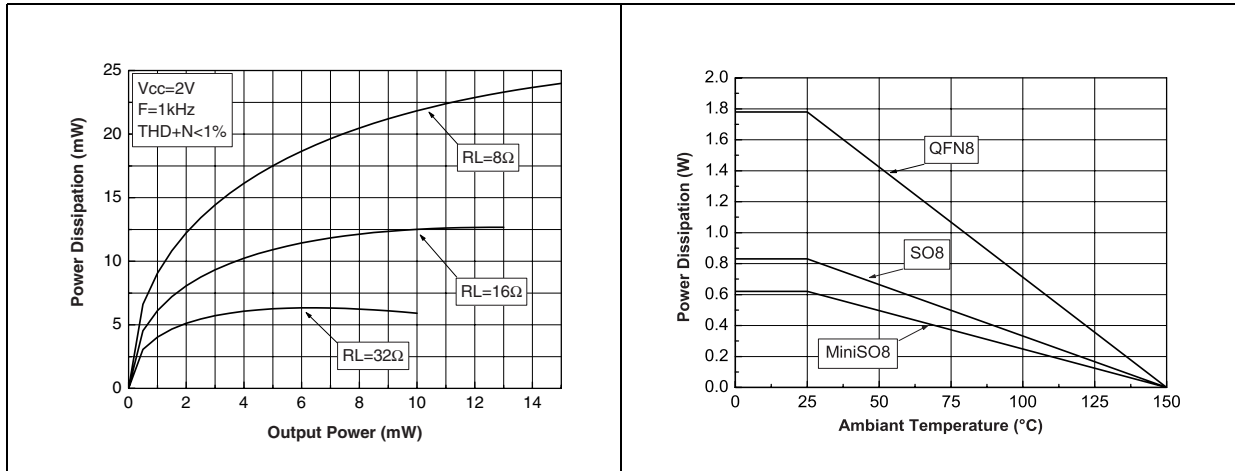

Figure 33. Current consumption vs. power supply voltage Figure 34. Power supply rejection ratio vs. frequency

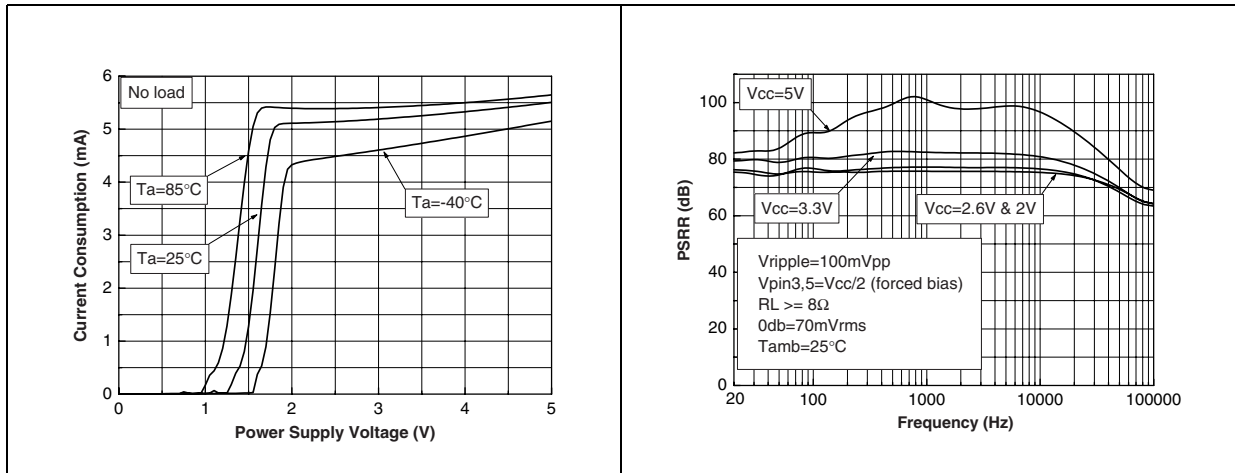

Figure 35. THD + N vs. output power Figure 36. THD + N vs. output power

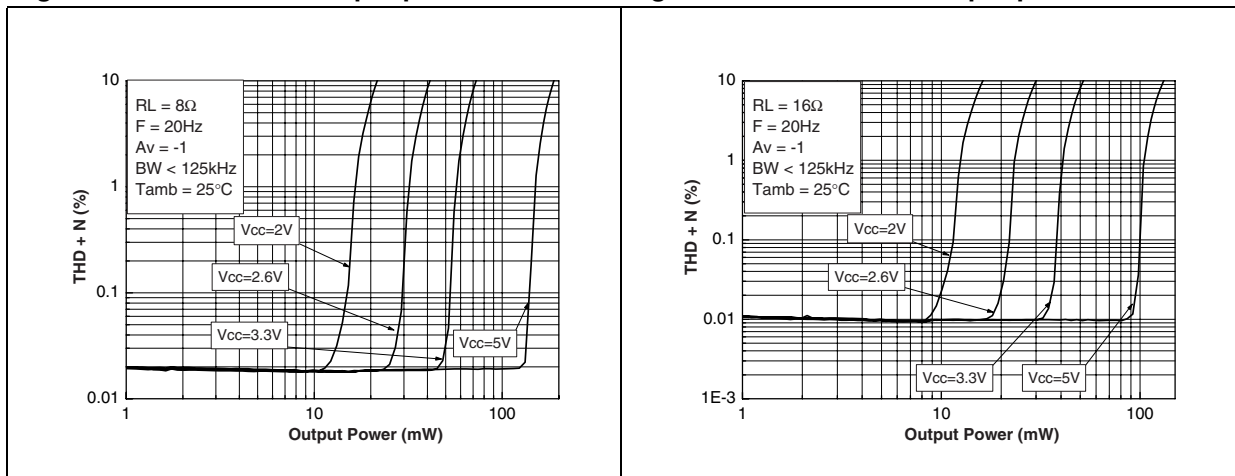

Figure 37. THD + N vs. output power

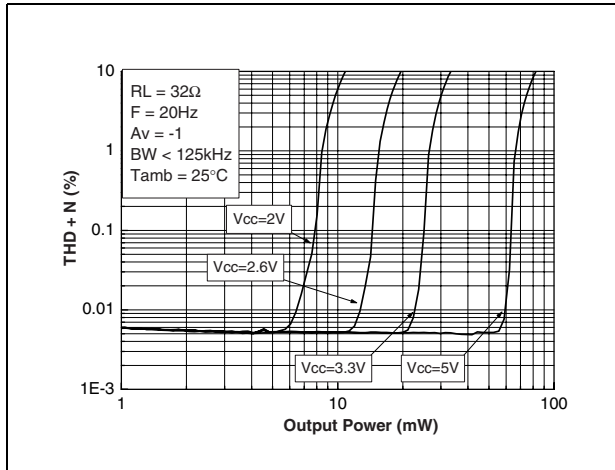

Figure 38. THD + N vs. output power

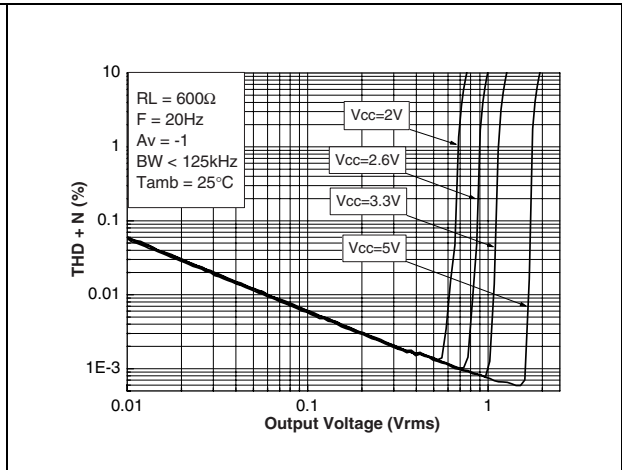

Figure 39. THD + N vs. output power

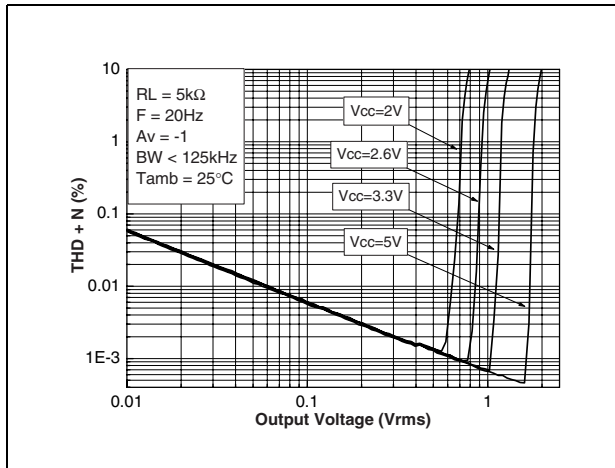

Figure 40. THD + N vs. output power

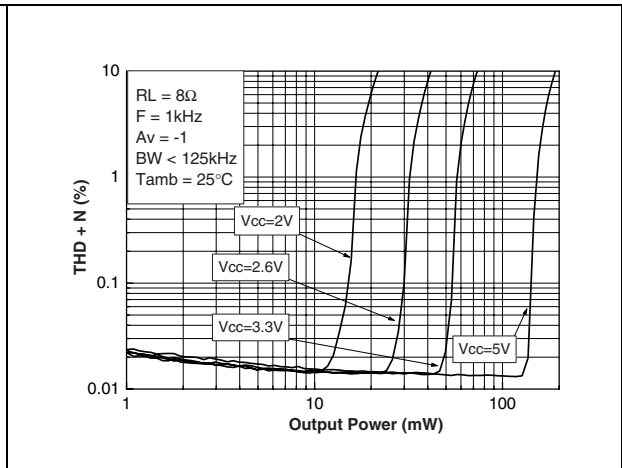

Figure 41. THD + N vs. output power

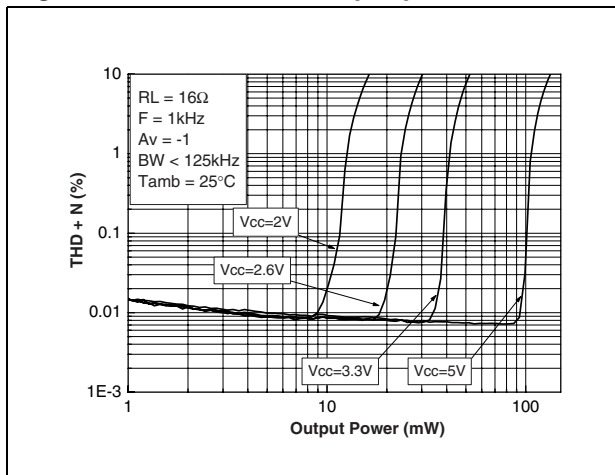

Figure 42. THD + N vs. output power

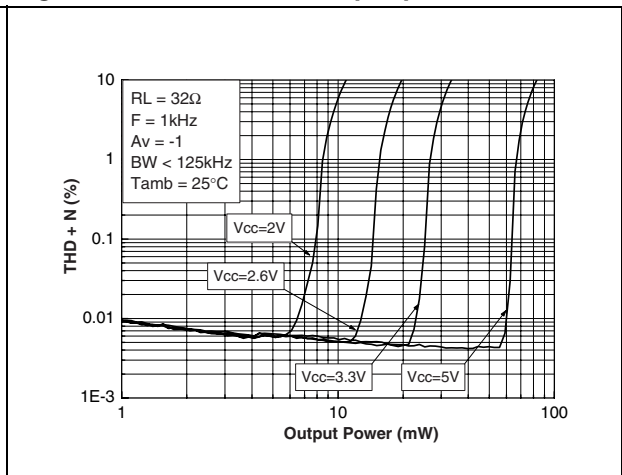

Figure 43. THD + N vs. output power

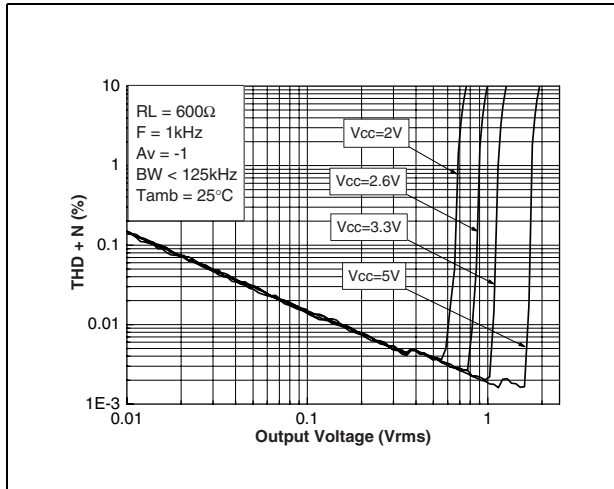

Figure 44. THD + N vs. output power

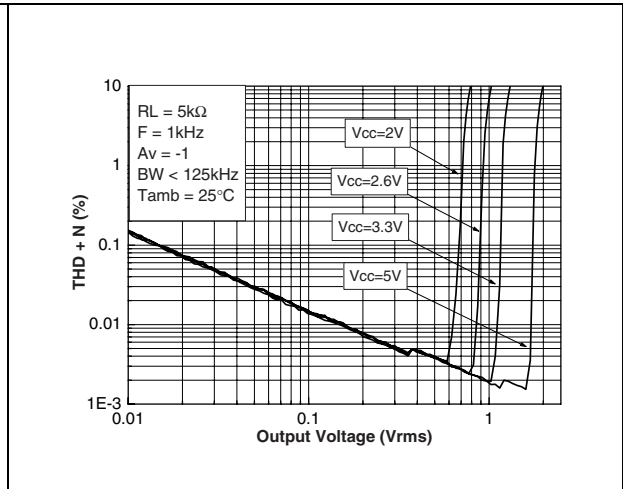

Figure 45. THD + N vs. output power

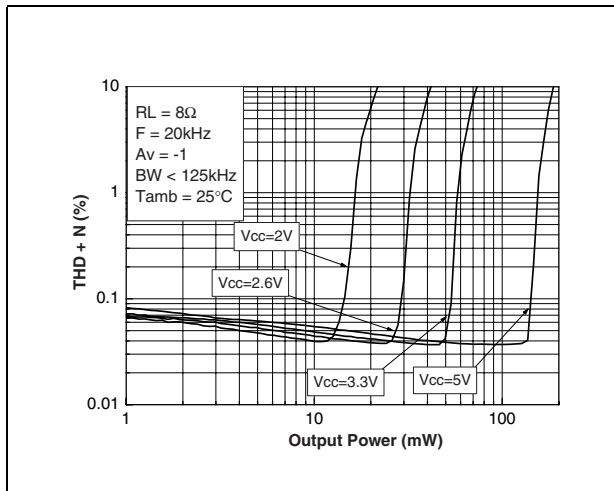

Figure 46. THD + N vs. output power

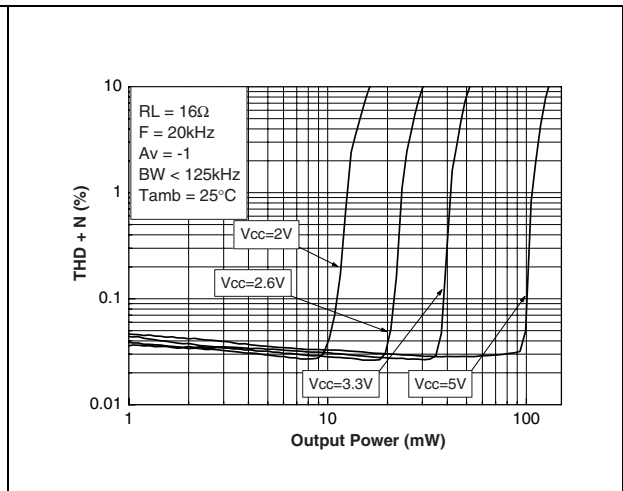

Figure 47. THD + N vs. output power

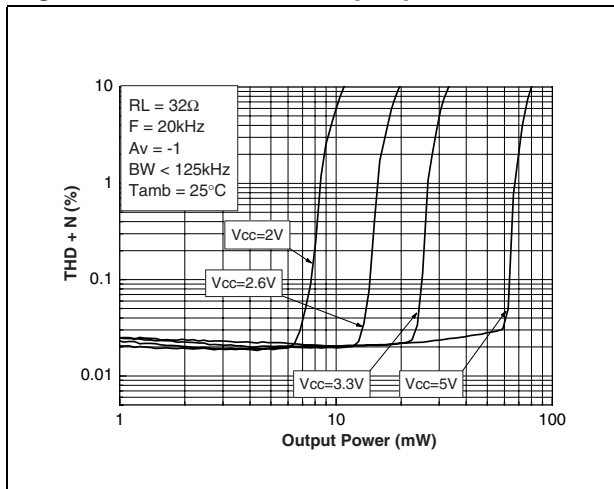

Figure 48. THD + N vs. output power

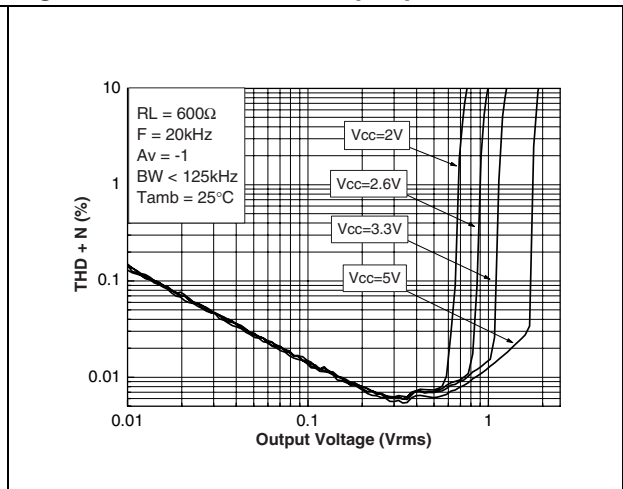

Figure 49. THD + N vs. output power

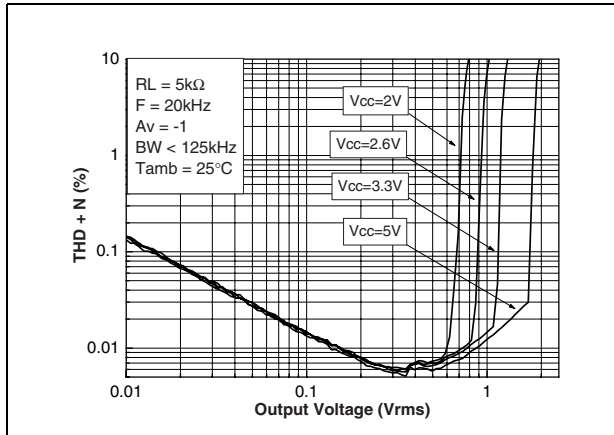

Figure 50. THD + N vs. frequency

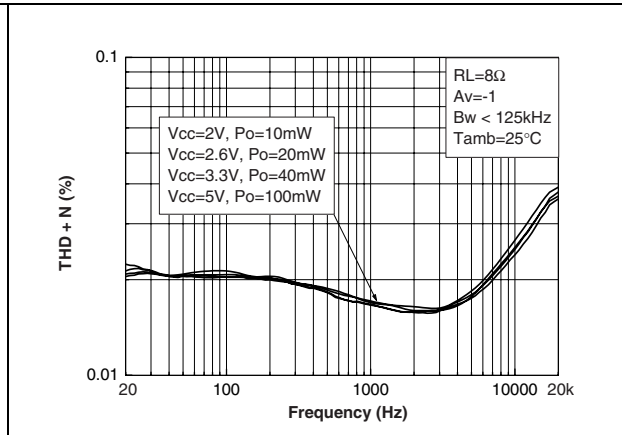

Figure 51. THD + N vs. frequency

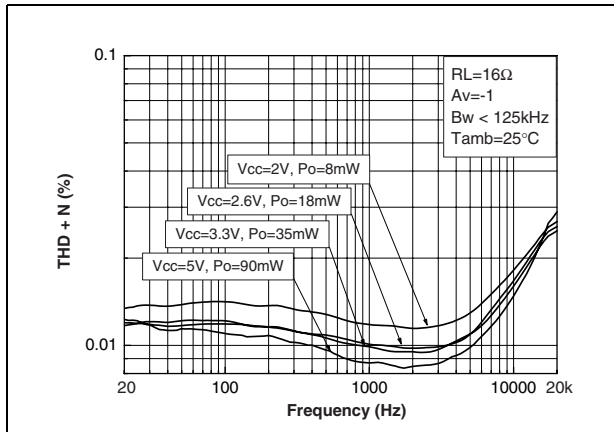

Figure 52. THD + N vs. frequency

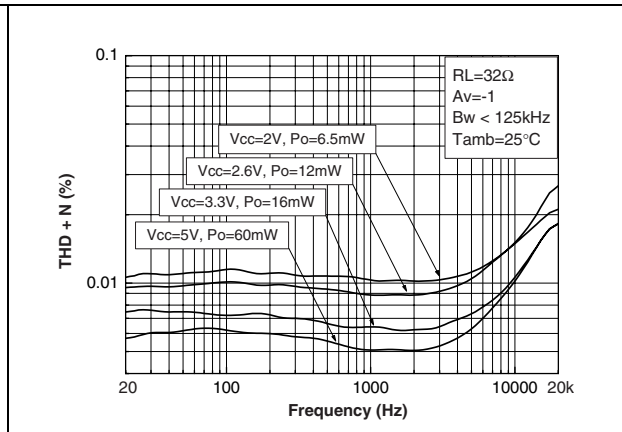

Figure 53. THD + N vs. frequency

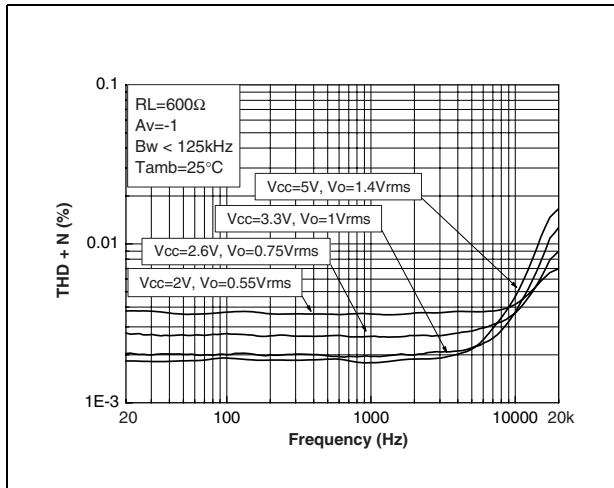

Figure 54. THD + N vs. frequency

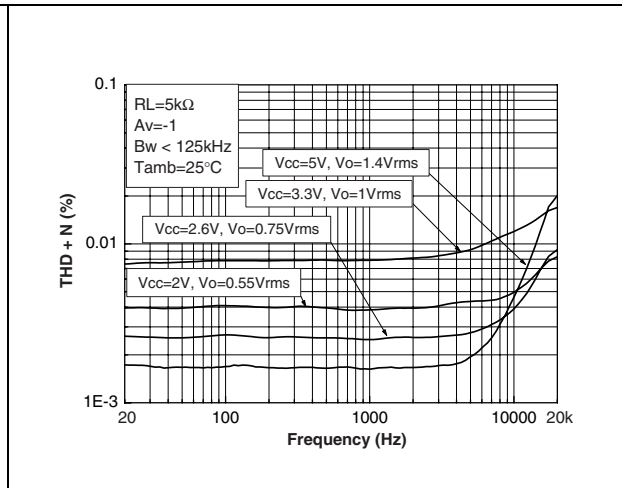

Figure 55. Signal to noise ratio vs. power supply with unweighted filter (20Hz to 20kHz)

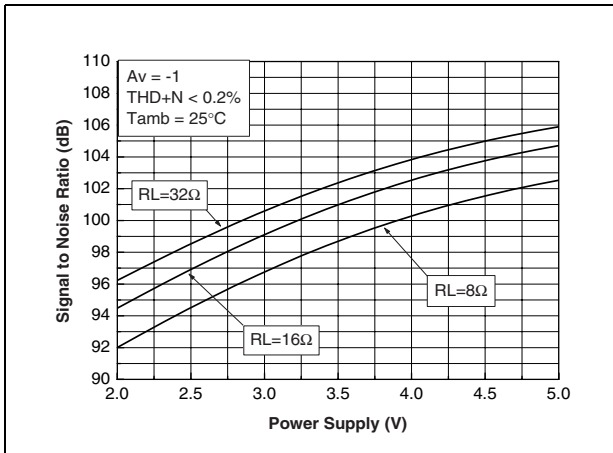

Figure 56. Signal to noise ratio vs. power supply with unweighted filter (20Hz to 20kHz)

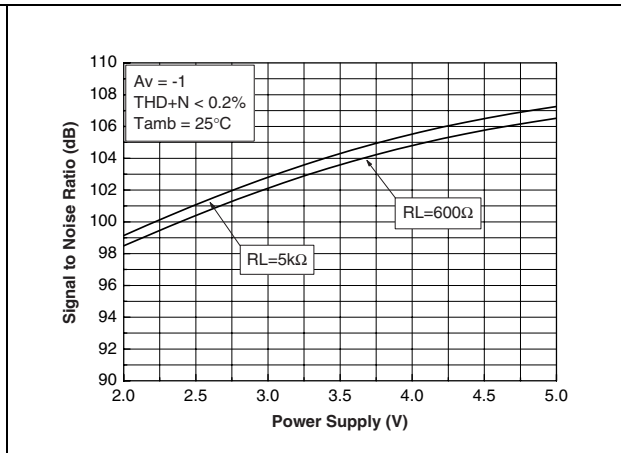

Figure 57. Signal to noise ratio vs. power supply with A weighted filter

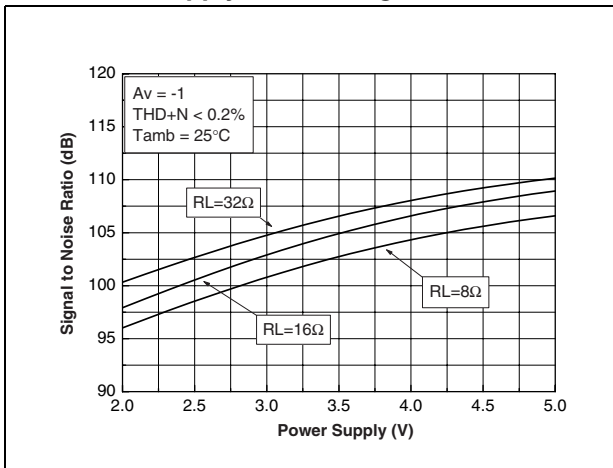

Figure 58. Signal to noise ratio vs. power supply with A weighted filter

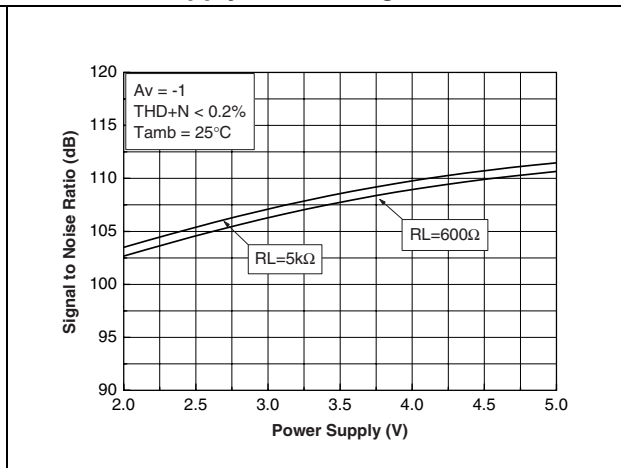

Figure 59. Equivalent input noise voltage vs. frequency

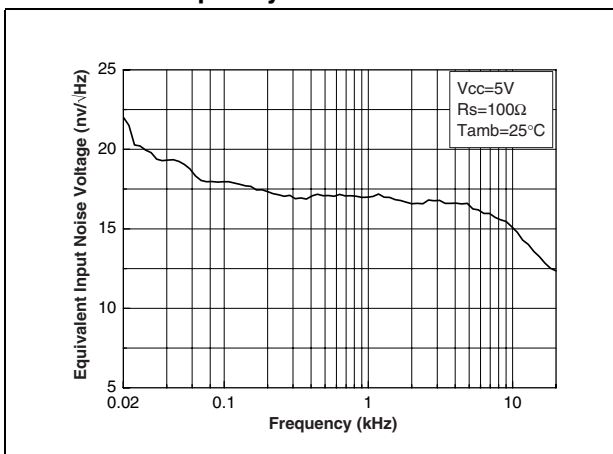

Figure 60. Output voltage swing vs. power supply

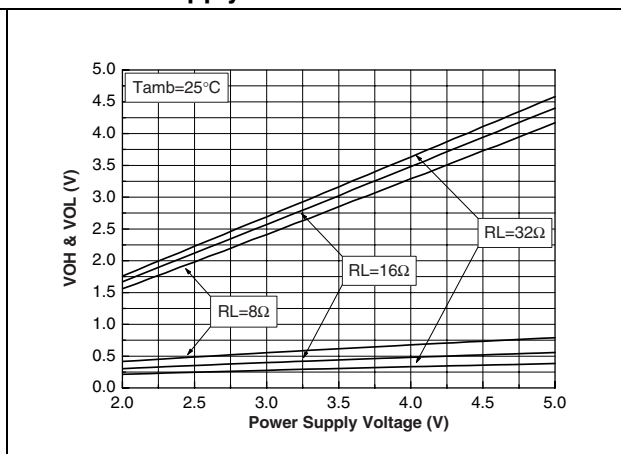

Figure 61. Crosstalk vs. frequency

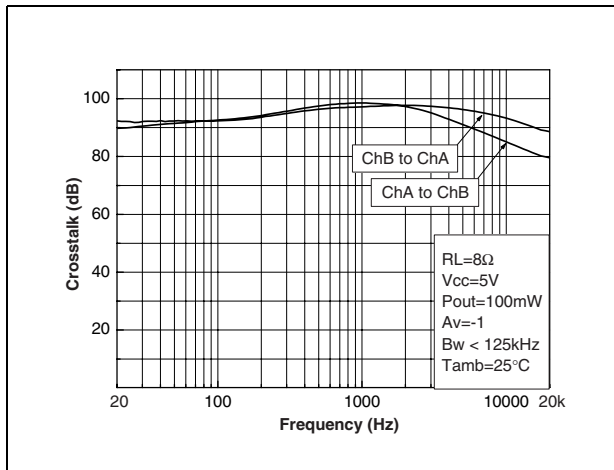

Figure 62. Crosstalk vs. frequency

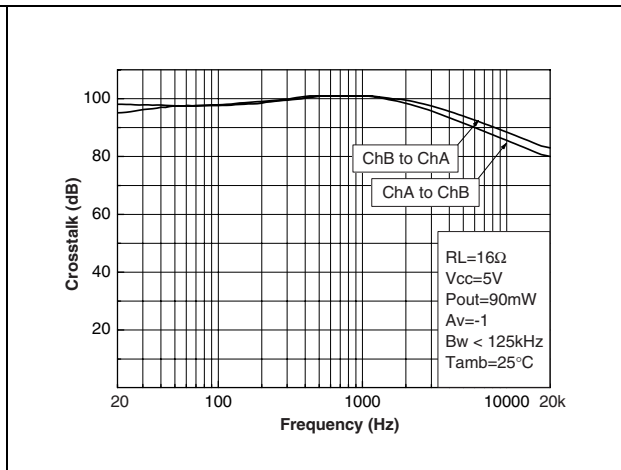

Figure 63. Crosstalk vs. frequency

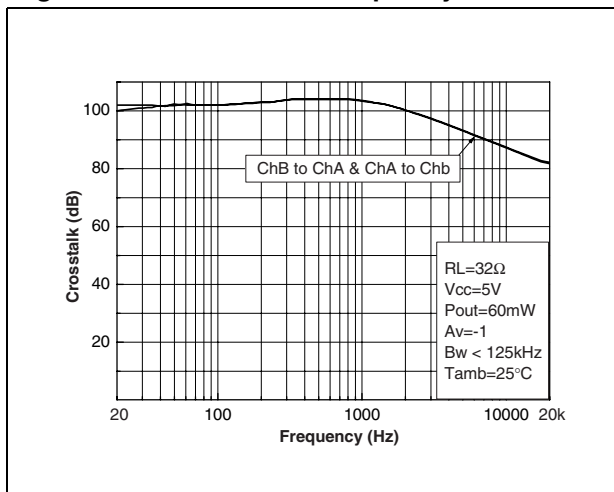

Figure 64. Crosstalk vs. frequency

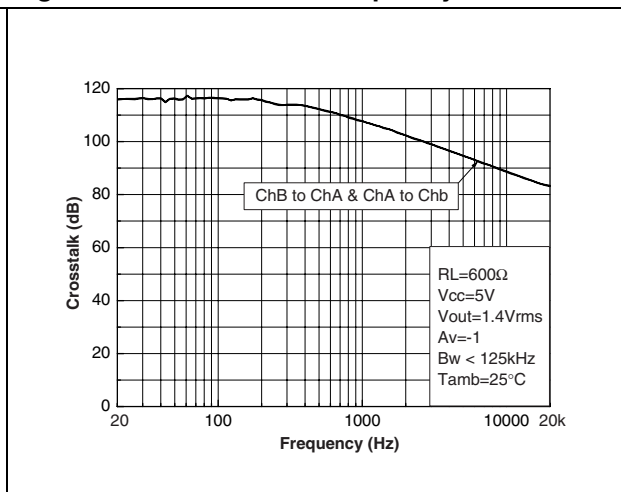

Figure 65. Crosstalk vs. frequency

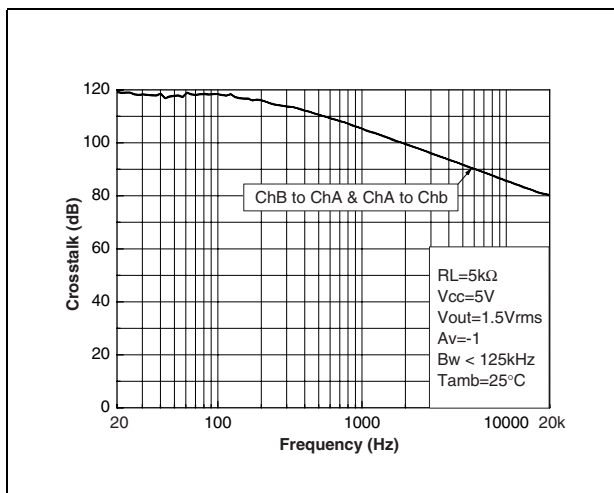

Figure 66. Lower cut off frequency vs. output capacitor

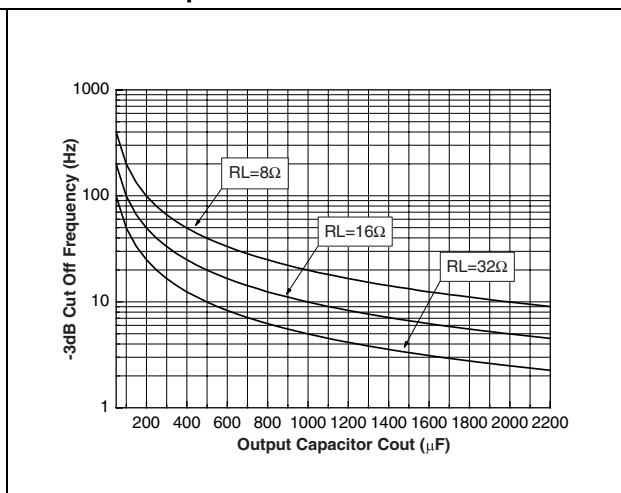

Figure 67. Lower cut off frequency vs. input capacitor

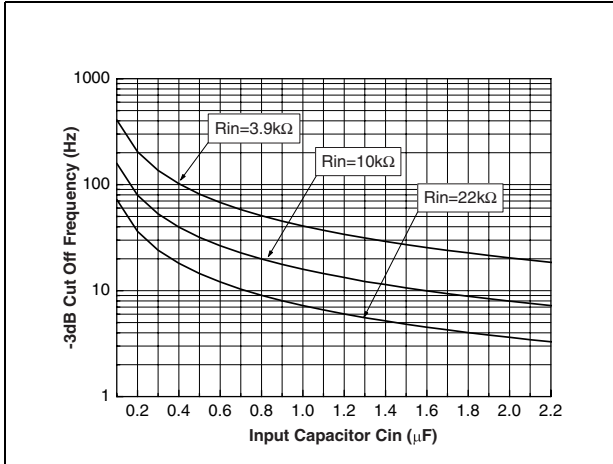

Figure 68. Typical distribution of THD + N

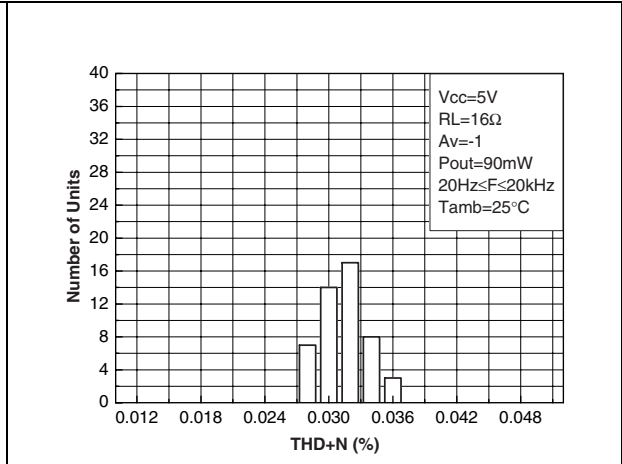

Figure 69. Best case distribution of THD + N

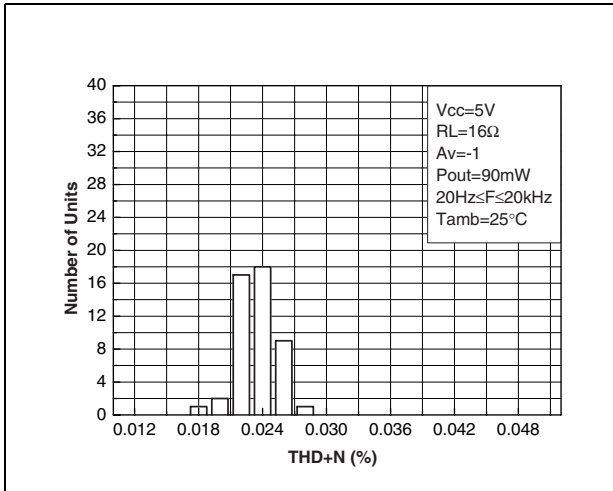

Figure 70. Worst case distribution of THD + N

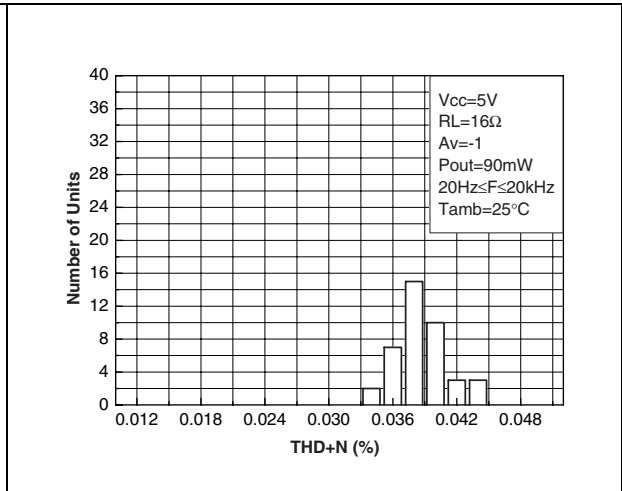

Figure 71. Typical distribution of THD + N

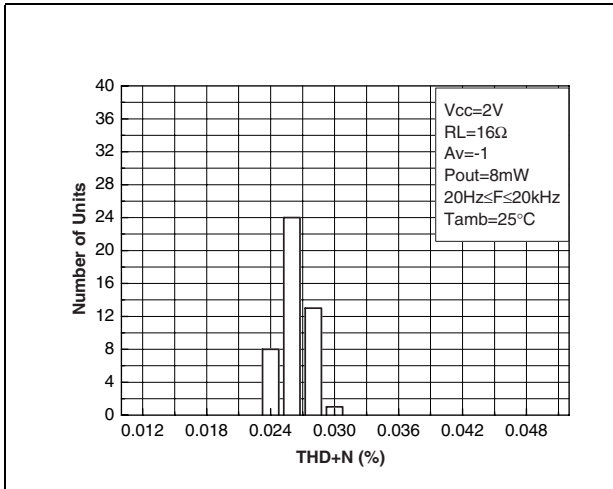

Figure 72. Best case distribution of THD + N

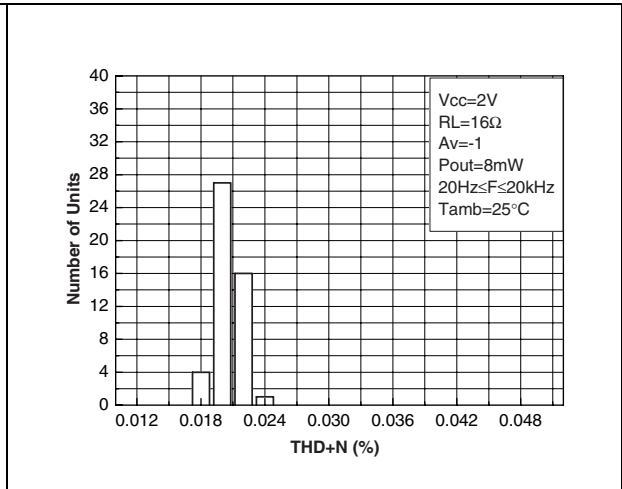

Figure 73. Worst case distribution of THD + N

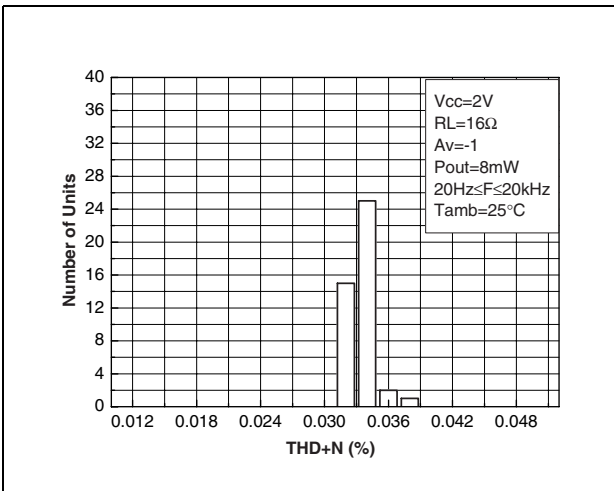

Figure 74. Typical distribution of TDH + N

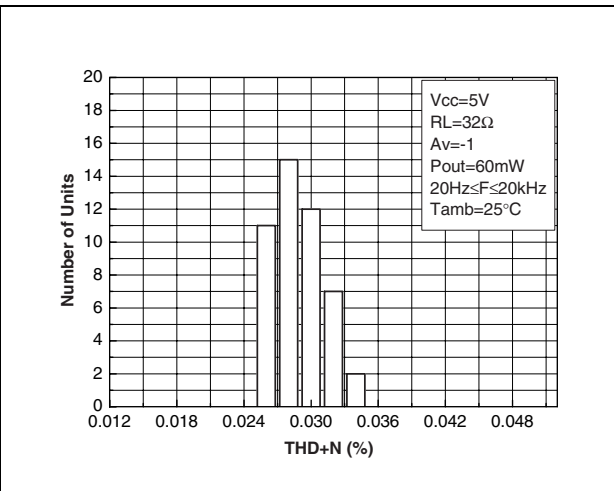

Figure 75. Best case distribution of THD + N

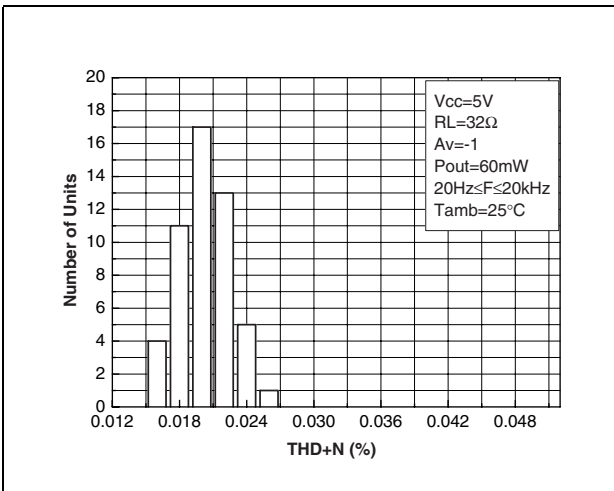

Figure 76. Worst case distribution of THD + N

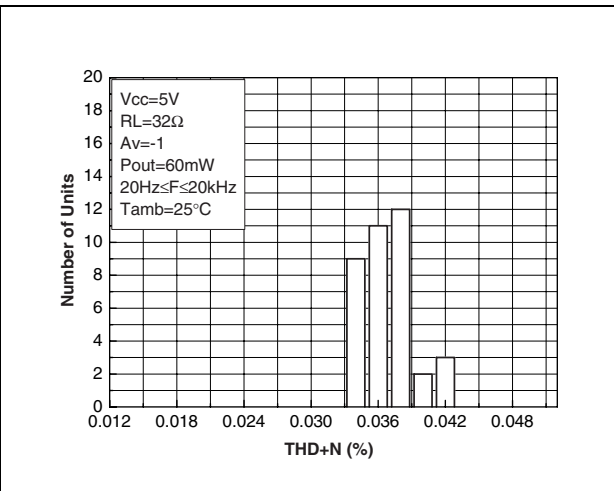

Figure 77. Typical distribution of TDH + N

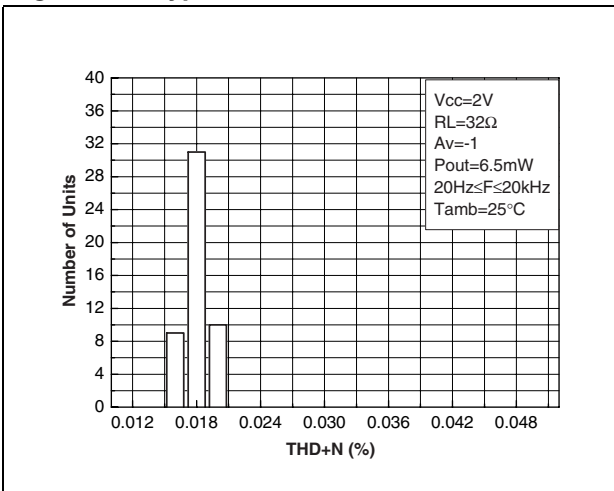

Figure 78. Best case distribution of THD + N

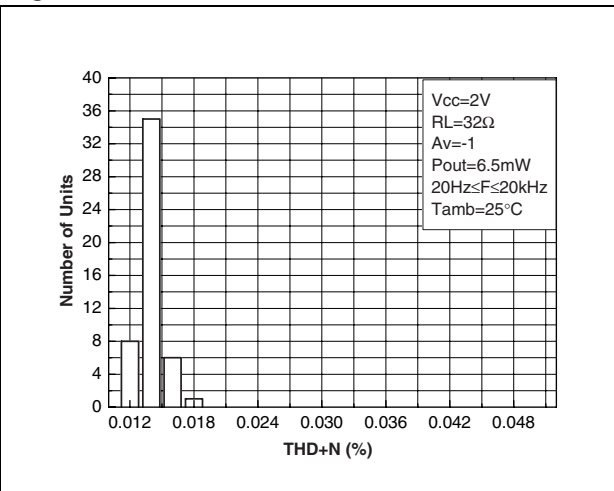
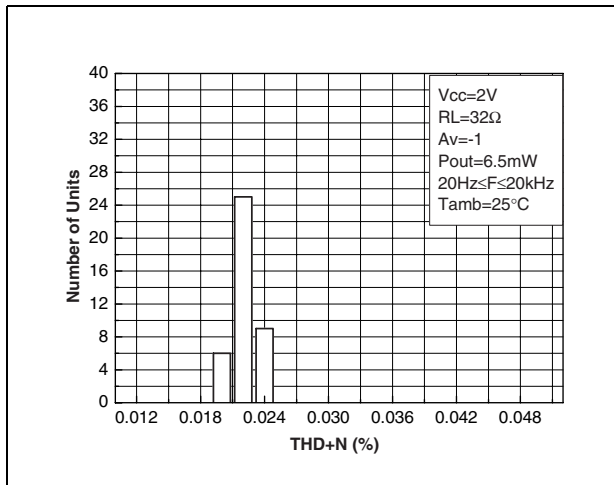

Figure 79. Worst case distribution of THD + N



3 Package Mechanical Data

In order to meet environmental requirements, ST offers these devices in ECOPACK[®] packages. These packages have a Lead-free second level interconnect. The category of second level interconnect is marked on the package and on the inner box label, in compliance with JEDEC Standard JESD97. The maximum ratings related to soldering conditions are also marked on the inner box label. ECOPACK is an ST trademark. ECOPACK specifications are available at: www.st.com.

3.1 SO-8 Package

SO-8 MECHANICAL DATA						
DIM.	mm.			inch		
	MIN.	TYP.	MAX.	MIN.	TYP.	MAX.
A	1.35		1.75	0.053		0.069
A1	0.10		0.25	0.04		0.010
A2	1.10		1.65	0.043		0.065
B	0.33		0.51	0.013		0.020
C	0.19		0.25	0.007		0.010
D	4.80		5.00	0.189		0.197
E	3.80		4.00	0.150		0.157
e		1.27			0.050	
H	5.80		6.20	0.228		0.244
h	0.25		0.50	0.010		0.020
L	0.40		1.27	0.016		0.050
k	8° (max.)					
ddd			0.1			0.04

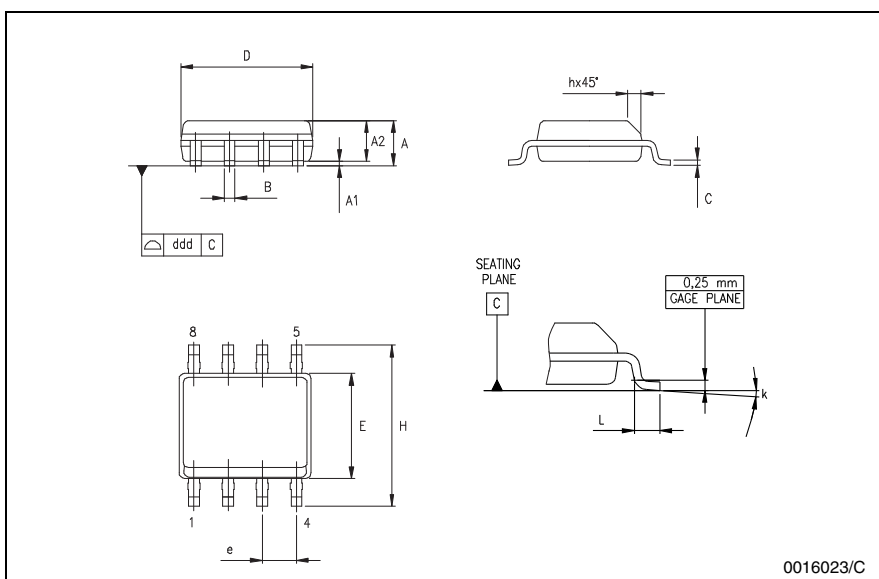

3.2 MiniSO-8 Package

miniSO-8 MECHANICAL DATA						
DIM.	mm.			inch		
	MIN.	TYP	MAX.	MIN.	TYP.	MAX.
A			1.1			0.043
A1	0.05	0.10	0.15	0.002	0.004	0.006
A2	0.78	0.86	0.94	0.031	0.031	0.037
b	0.25	0.33	0.40	0.010	0.13	0.013
c	0.13	0.18	0.23	0.005	0.007	0.009
D	2.90	3.00	3.10	0.114	0.118	0.122
E	4.75	4.90	5.05	0.187	0.193	0.199
E1	2.90	3.00	3.10	.0114	0.118	0.122
e		0.65			0.026	
K	0°		6°	0°		6°
L	0.40	0.55	0.70	0.016	0.022	0.028
L1			0.10			0.004

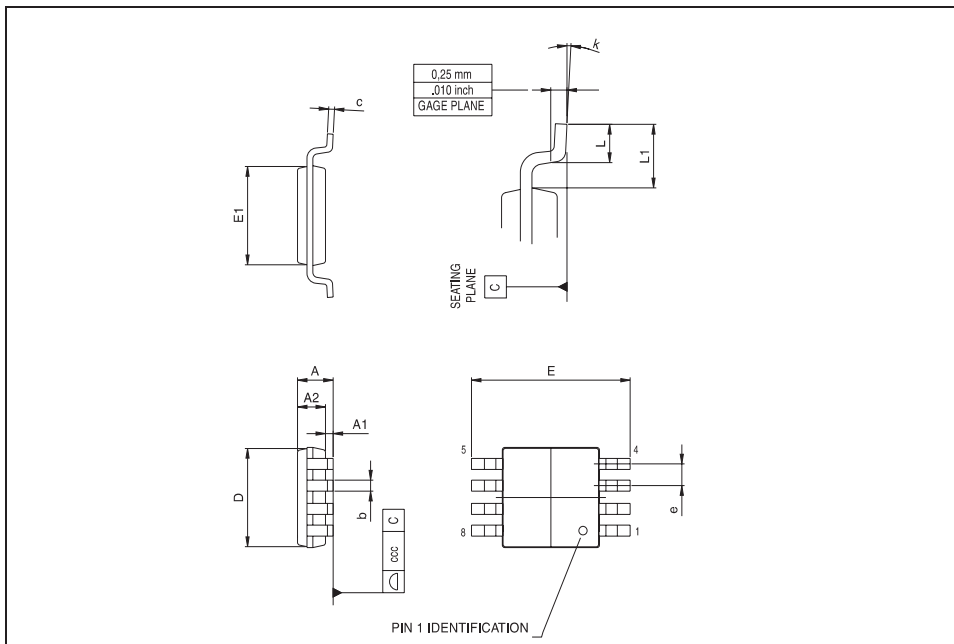

3.3 DFN8 Package

DFN8 (3x3) MECHANICAL DATA

DIM.	mm.			inch		
	MIN.	TYP	MAX.	MIN.	TYP.	MAX.
A	0.80	0.90	1.00	31.5	35.4	39.4
A1		0.02	0.05		0.8	2.0
A2		0.70			27.6	
A3		0.20			7.9	
b	0.18	0.23	0.30	7.1	9.1	11.8
D	2.875	3.00	3.125		118.1	
D2	2.23	2.38	2.48	87.8	93.7	97.7
E	2.875	3.00	3.125		118.1	
E2	1.49	1.64	1.74	58.7	64.6	68.5
e		0.50			19.7	
L	0.30	0.40	0.50	11.8	15.7	19.7

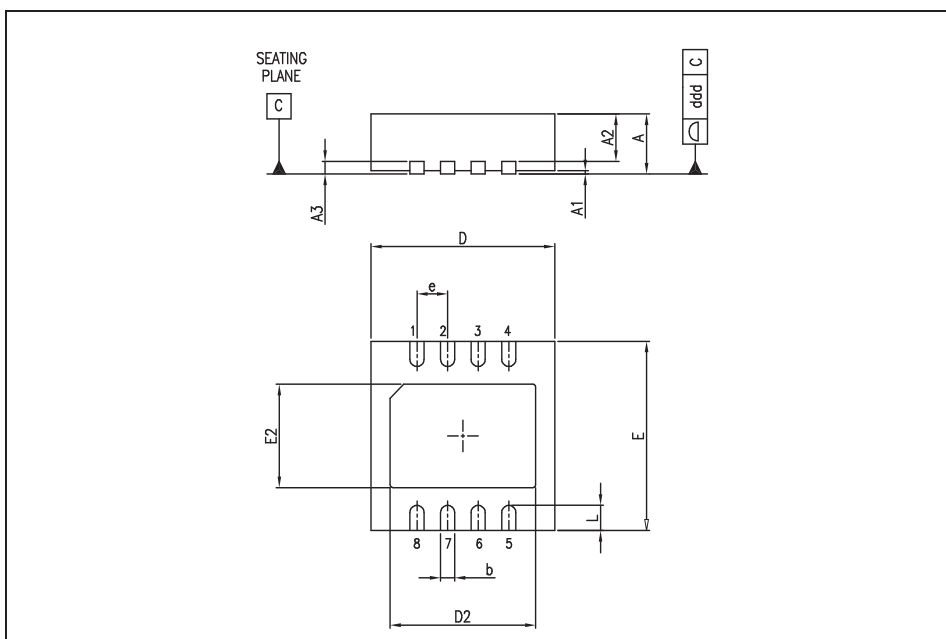

4 Revision history

Date	Revision	Changes
June 2003	1	Initial release.
Nov. 2005	2	The following changes were made in this revision: <ul style="list-style-type: none">– Lead temperature for lead-free added see Table 1: Key parameters and their absolute maximum ratings on page 2.– Formatting changes throughout.

Information furnished is believed to be accurate and reliable. However, STMicroelectronics assumes no responsibility for the consequences of use of such information nor for any infringement of patents or other rights of third parties which may result from its use. No license is granted by implication or otherwise under any patent or patent rights of STMicroelectronics. Specifications mentioned in this publication are subject to change without notice. This publication supersedes and replaces all information previously supplied. STMicroelectronics products are not authorized for use as critical components in life support devices or systems without express written approval of STMicroelectronics.

The ST logo is a registered trademark of STMicroelectronics.
All other names are the property of their respective owners

© 2005 STMicroelectronics - All rights reserved

STMicroelectronics group of companies

Australia - Belgium - Brazil - Canada - China - Czech Republic - Finland - France - Germany - Hong Kong - India - Israel - Italy - Japan - Malaysia - Malta - Morocco - Singapore - Spain - Sweden - Switzerland - United Kingdom - United States of America

www.st.com

Компания «Океан Электроники» предлагает заключение долгосрочных отношений при поставках импортных электронных компонентов на взаимовыгодных условиях!

Наши преимущества:

- Поставка оригинальных импортных электронных компонентов напрямую с производств Америки, Европы и Азии, а так же с крупнейших складов мира;
- Широкая линейка поставок активных и пассивных импортных электронных компонентов (более 30 млн. наименований);
- Поставка сложных, дефицитных, либо снятых с производства позиций;
- Оперативные сроки поставки под заказ (от 5 рабочих дней);
- Экспресс доставка в любую точку России;
- Помощь Конструкторского Отдела и консультации квалифицированных инженеров;
- Техническая поддержка проекта, помощь в подборе аналогов, поставка прототипов;
- Поставка электронных компонентов под контролем ВП;
- Система менеджмента качества сертифицирована по Международному стандарту ISO 9001;
- При необходимости вся продукция военного и аэрокосмического назначения проходит испытания и сертификацию в лаборатории (по согласованию с заказчиком);
- Поставка специализированных компонентов военного и аэрокосмического уровня качества (Xilinx, Altera, Analog Devices, Intersil, Interpoint, Microsemi, Actel, Aeroflex, Peregrine, VPT, Syfer, Eurofarad, Texas Instruments, MS Kennedy, Miteq, Cobham, E2V, MA-COM, Hittite, Mini-Circuits, General Dynamics и др.);

Компания «Океан Электроники» является официальным дистрибьютором и эксклюзивным представителем в России одного из крупнейших производителей разъемов военного и аэрокосмического назначения «JONHON», а так же официальным дистрибьютором и эксклюзивным представителем в России производителя высокотехнологичных и надежных решений для передачи СВЧ сигналов «FORSTAR».



JONHON

«JONHON» (основан в 1970 г.)

Разъемы специального, военного и аэрокосмического назначения:

(Применяются в военной, авиационной, аэрокосмической, морской, железнодорожной, горно- и нефтедобывающей отраслях промышленности)

«FORSTAR» (основан в 1998 г.)

ВЧ соединители, коаксиальные кабели, кабельные сборки и микроволновые компоненты:

(Применяются в телекоммуникациях гражданского и специального назначения, в средствах связи, РЛС, а так же военной, авиационной и аэрокосмической отраслях промышленности).



Телефон: 8 (812) 309-75-97 (многоканальный)

Факс: 8 (812) 320-03-32

Электронная почта: ocean@oceanchips.ru

Web: <http://oceanchips.ru/>

Адрес: 198099, г. Санкт-Петербург, ул. Калинина, д. 2, корп. 4, лит. А