

CMOS LDO Regulator Series for Portable Equipments

Versatile Package FULL CMOS LDO Regulator



BUxxTD2WNVX series

●General Description

BUxxTD2WNVX series is high-performance FULL CMOS regulator with 200-mA output, which is mounted on versatile package SSON004X1010 (1.00mm × 1.00 mm × 0.60mm). It has excellent noise characteristics and load responsiveness characteristics despite its low circuit current consumption of 35μA. It is most appropriate for various applications such as power supplies for logic IC, RF, and camera modules.ROHM's.

●Features

- High accuracy detection
- low current consumption
- Compatible with small ceramic capacitor(Cin=Co=0.47uF)
- With built-in output discharge circuit
- High ripple rejection
- ON/OFF control of output voltage
- With built-in over current protection circuit and thermal shutdown circuit
- Low dropout voltage

●Key Specifications

- Output voltage: 1.0V to 3.4V
- Accuracy output voltage: ±1.0% (±25mV)
- Low current consumption: 35μA
- Operating temperature range: -40°C to +85°C

●Applications

Battery-powered portable equipment, etc.

●Package

SSON004X1010 : 1.00mm x 1.00mm x 0.60mm



●Typical Application Circuit

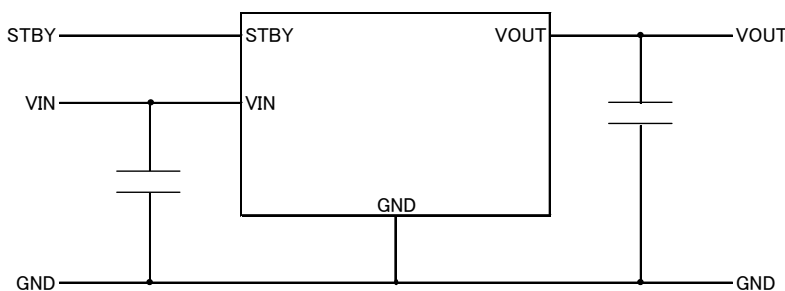
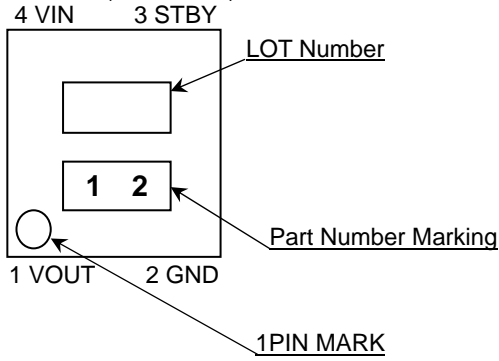

Fig.1 Application Circuit

○Product structure:Silicon monolithic integrated circuit ○This product is not designed protection against radioactive rays.

● Connection Diagram

SSON004X1010 (TOP VIEW)



BOTTOM VIEW

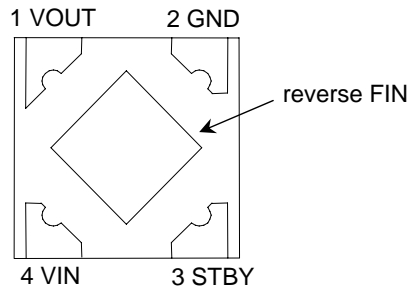

● Pin Descriptions

SSON004X1010		
PIN No.	Symbol	Function
1	VOUT	Output Voltage
2	GND	Grounding
3	STBY	ON/OFF control of output voltage (High: ON, Low: OFF)
4	VIN	Power Supply Voltage
reverse	FIN	Substrate (Connect to GND)

● Ordering Information

B U x x T D 2 W N V X - T L					
Part Number	Output Voltage 10 : 1.0V ↓ 34 : 3.4V	Low Dropout Voltage Maximum Output Current 200mA	with output discharge	Package INVX : SSON004X1010	Packageing and forming specification Embossed tape and reel TL : The pin number 1 is the lower left

SSON004X1010

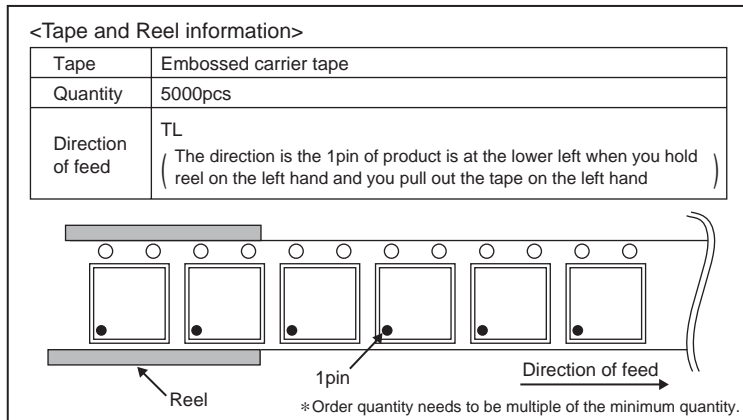
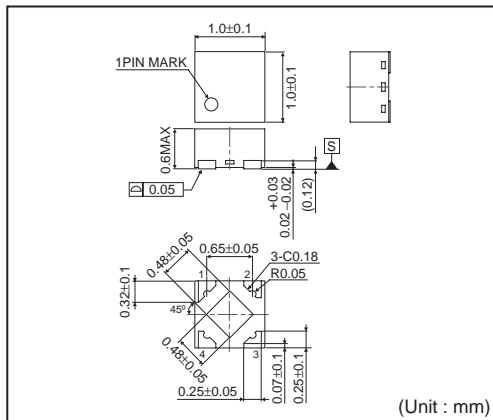

●Lineup

Marking	A	6	5	2	B	3	5i	C	D
Output Voltage	1.0V	1.05V	1.1V	1.15V	1.2V	1.25V	1.3V	1.5V	1.8V
Part Number	BU10	BU1A	BU11	BU1B	BU12	BU1C	BU13	BU15	BU18

E	F	G	r	0	1	H	J	K
1.85V	1.9V	2.0V	2.05V	2.1V	2.3V	2.5V	2.6V	2.7V
BU1J	BU19	BU20	BU2A	BU21	BU23	BU25	BU26	BU27

a	L	M	N	P	Q	R	U	Y
2.75V	2.8V	2.85V	2.9V	3.0V	3.1V	3.2V	3.3V	3.4V
BU2H	BU28	BU2J	BU29	BU30	BU31	BU32	BU33	BU34

●Absolute Maximum Ratings (Ta=25°C)

PARAMETER	Symbol	Limit	Unit
Power Supply Voltage	VMAX	-0.3 ~ +6.5	V
Power Dissipation	Pd	560(*1)	mW
Maximum junction temperature	TjMAX	+125	°C
Operating Temperature Range	Topr	-40 ~ +85	°C
Storage Temperature Range	Tstg	-55 ~ +125	°C

(*1)Pd deleted at 5.6mW/°C at temperatures above Ta=25°C, mounted on 70x70x1.6 mm glass-epoxy PCB.

●RECOMMENDED OPERATING RANGE (not to exceed Pd)

PARAMETER	Symbol	Limit	Unit
Power Supply Voltage	VIN	1.7~6.0	V
Maximum Output Current	IMAX	200	mA

●OPERATING CONDITIONS

PARAMETER	Symbol	MIN.	TYP.	MAX.	Unit	CONDITION
Input Capacitor	Cin	0.22(*2)	0.47	-	μF	Ceramic capacitor recommended
Output Capacitor	Co	0.22(*2)	0.47	-	μF	

(*2)Make sure that the output capacitor value is not kept lower than this specified level across a variety of temperature, DC bias, changing as time progresses characteristic.

●Electrical Characteristics

(Ta=25°C, VIN=VOUT+1.0V (*3), STBY=VIN, Cin=0.47μF, Co=0.47μF, unless otherwise noted.)

PARAMETER	Symbol	Limit			Unit	Conditions
		MIN.	TYP.	MAX.		
Overall Device						
Output Voltage	VOUT	$V_{OUT} \times 0.99$	VOUT	$V_{OUT} \times 1.01$	V	$I_{OUT}=10\mu A, V_{OUT} \geq 2.5V$
		$V_{OUT}-25mV$		$V_{OUT}+25mV$		$I_{OUT}=10\mu A, V_{OUT} < 2.5V$
Operating Current	IIN	-	35	60	μA	$I_{OUT}=0mA$
Operating Current (STBY)	ISTBY	-	-	1.0	μA	STBY=0V
Ripple Rejection Ratio	RR	45	70	-	dB	$V_{RR}=-20dBv, f_{RR}=1kHz, I_{OUT}=10mA$
Dropout Voltage	VSAT	-	800	1100	mV	$1.0V \leq V_{OUT} < 1.2V (I_{OUT}=200mA)$
		-	600	900	mV	$1.2V \leq V_{OUT} < 1.5V (I_{OUT}=200mA)$
		-	440	700	mV	$1.5V \leq V_{OUT} < 1.8V (I_{OUT}=200mA)$
		-	380	600	mV	$1.8V \leq V_{OUT} < 2.5V (I_{OUT}=200mA)$
		-	280	540	mV	$2.5V \leq V_{OUT} \leq 2.6V (I_{OUT}=200mA)$
		-	260	500	mV	$2.7V \leq V_{OUT} \leq 2.85V (I_{OUT}=200mA)$
		-	240	460	mV	$2.9V \leq V_{OUT} \leq 3.1V (I_{OUT}=200mA)$
Line Regulation	VDL	-	2	20	mV	$V_{IN}=V_{OUT}+1.0V$ to 5.5V (*4), $I_{OUT}=10\mu A$
Load Regulation	VDLO	-	10	80	mV	$I_{OUT}=0.01mA$ to 100mA
Over Current Protection (OCP)						
Limit Current	ILMAX	220	400	700	mA	$V_o=V_{OUT} \times 0.95$
Short Current	ISHORT	20	70	150	mA	$V_o=0V$
Standby Block						
Discharge Resistor	RDSC	20	50	80	Ω	$V_{IN}=4.0V, STBY=0V, V_{OUT}=4.0V$
STBY Pin Pull-down Current	ISTB	0.1	0.6	2.0	μA	STBY=1.5V
STBY Control Voltage	ON	VSTBH	1.2	-	6.0	V
	OFF	VSTBL	-0.3	-	0.3	V

This product is not designed for protection against radioactive rays.

(*3) VIN=2.5V for VOUT ≤ 1.5V

(*4) VIN=2.5V to 3.6V for VOUT ≤ 1.5V

●Block Diagrams

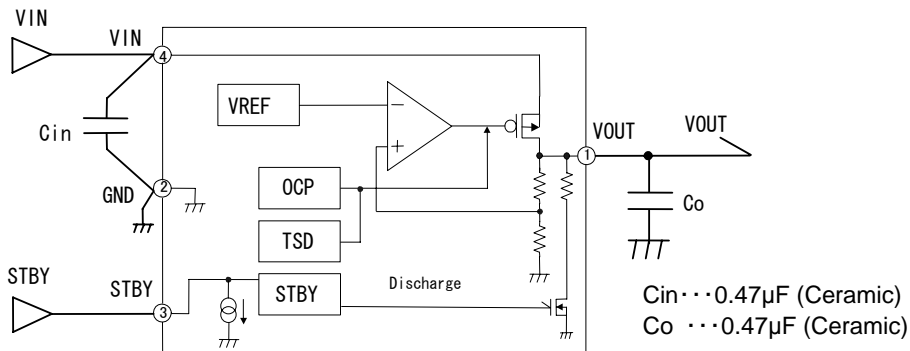

Fig. 2 Block Diagrams

●Reference data BU12TD2WNVX (Ta=25°C unless otherwise specified.)

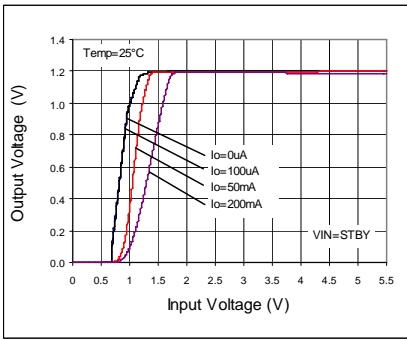

Fig 3. Output Voltage

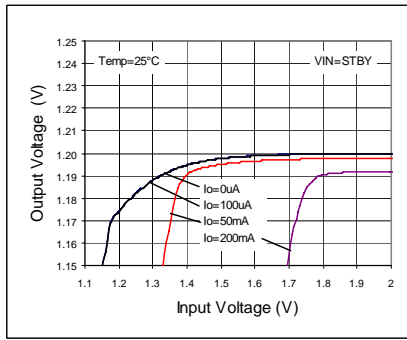

Fig 4. Line Regulation

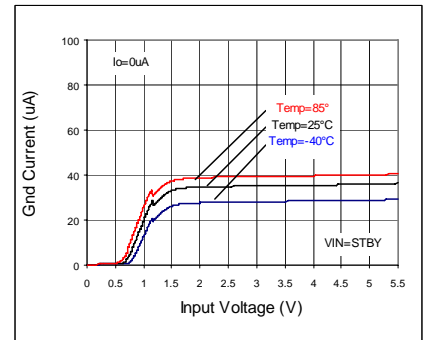

Fig 5. Circuit Current IGND

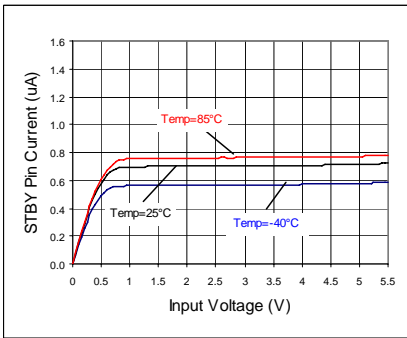

Fig 6. VSTBY - ISTBY

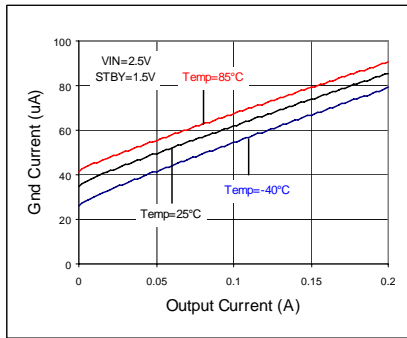

Fig 7. IOU - IGND

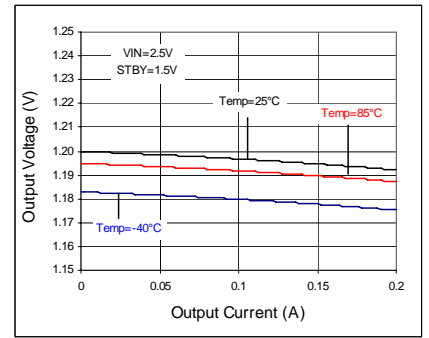

Fig 8. Load Regulation

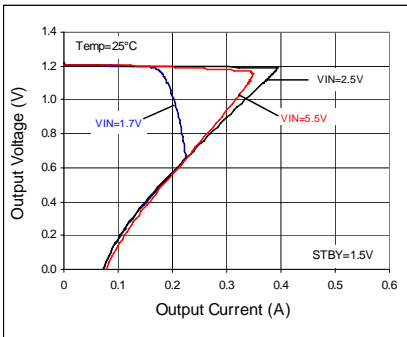

Fig 9. OCP Threshold

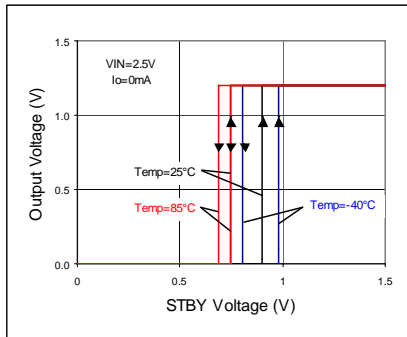

Fig 10. STBY Threshold

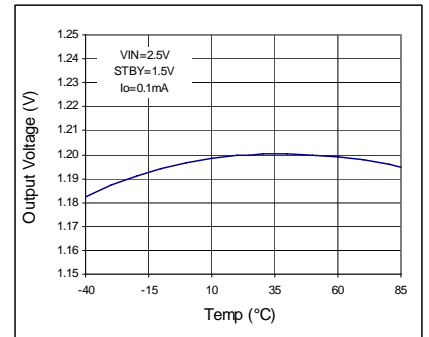

Fig 11. VOUT - Temp

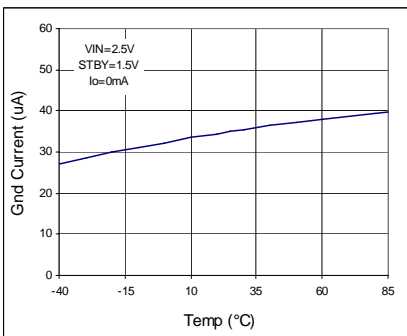

Fig 12. I_GND vs Temp

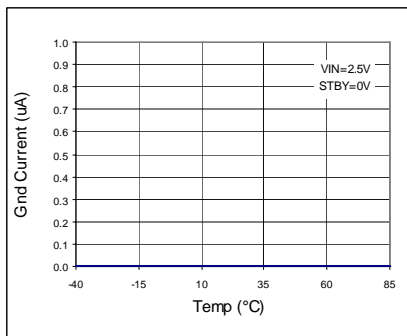

Fig 13. I_GND - Temp (STBY)

●Reference data BU12TD2WNVX (Ta=25°C unless otherwise specified.)

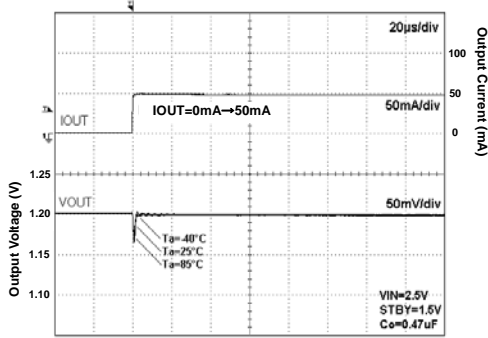

Fig 14. Load Response

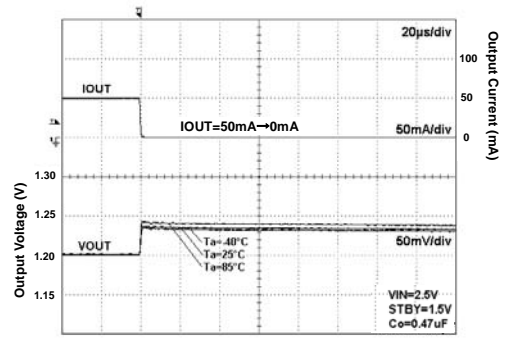

Fig 15. Load Response

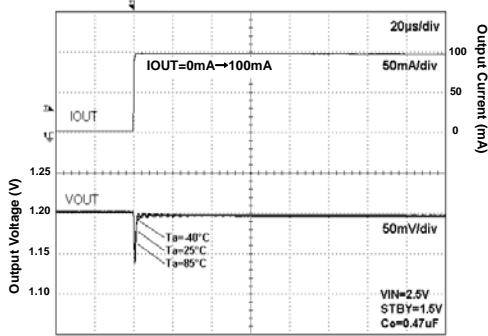

Fig 16. Load Response

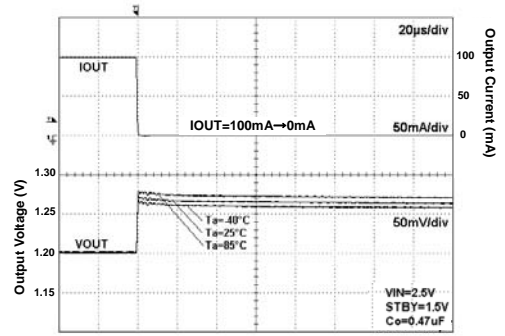

Fig 17. Load Response

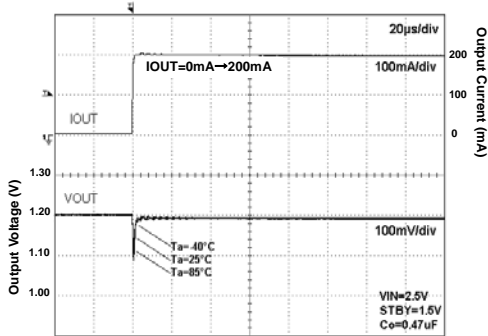

Fig 18. Load Response

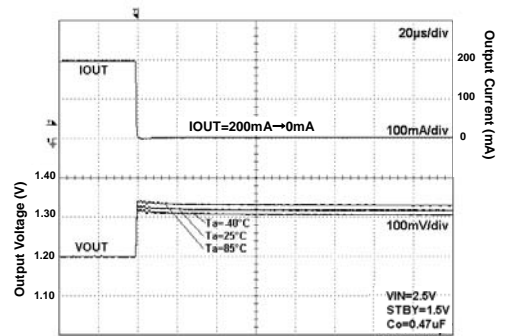

Fig 19. Load Response

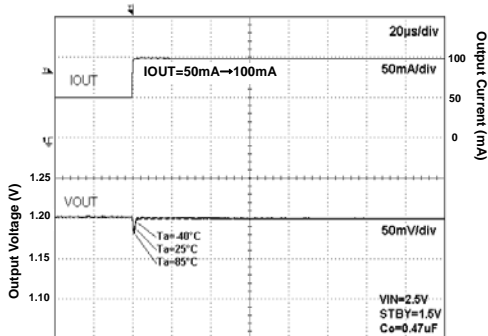

Fig 20. Load Response

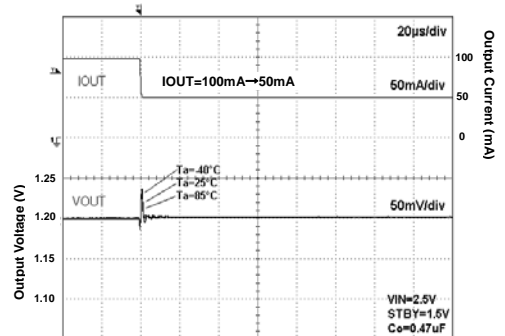

Fig 21. Load Response

●Reference data BU12TD2WNVX (Ta=25°C unless otherwise specified.)

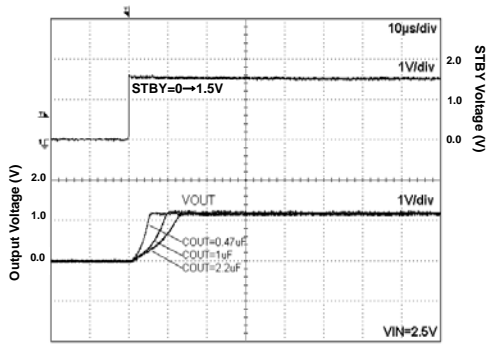

Fig 22. Start Up Time
Iout=0mA

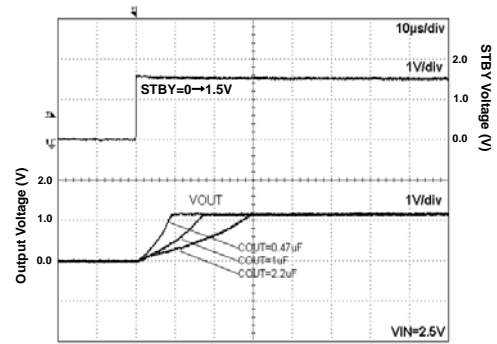

Fig 23. Start Up Time
Iout=200mA

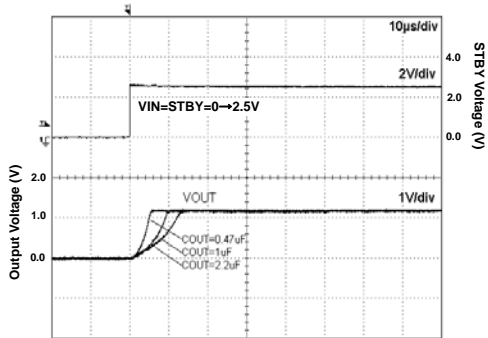

Fig 24. Start Up Time
(VIN=STBY) Iout=0mA
Iout=0mA

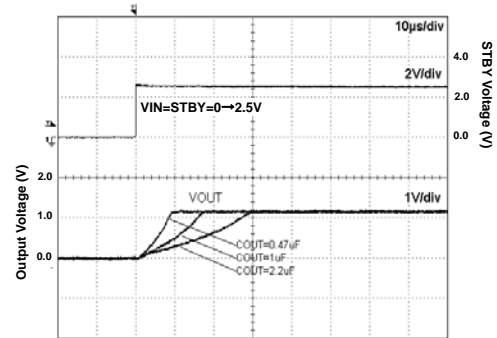

Fig 25. Start Up Time
(VIN=STBY) Iout=200mA

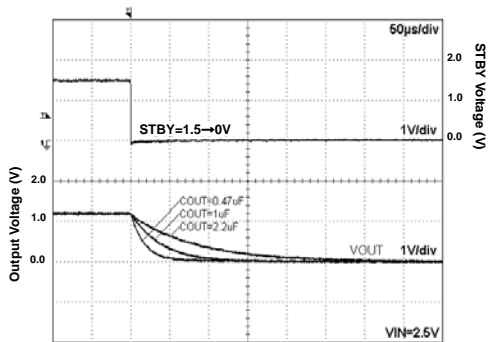

Fig 26. Discharge Time

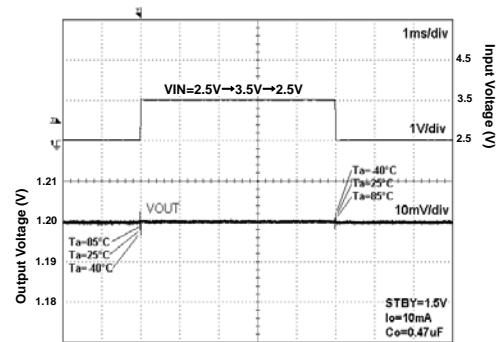

Fig 27. VIN Response

●Reference data BU15TD2WNVX (Ta=25°C unless otherwise specified.)

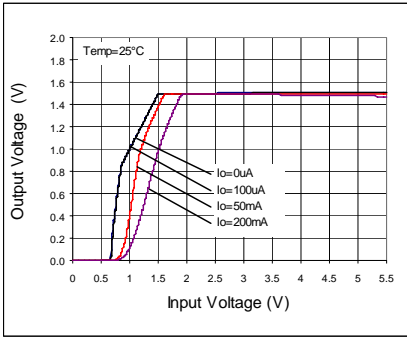

Fig 28. Output Voltage

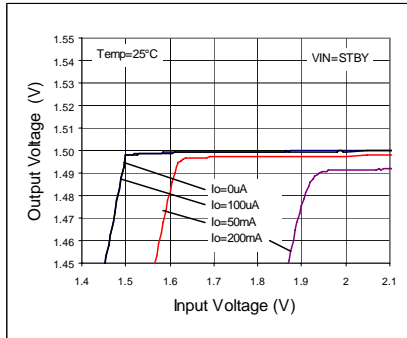

Fig 29. Line Regulation

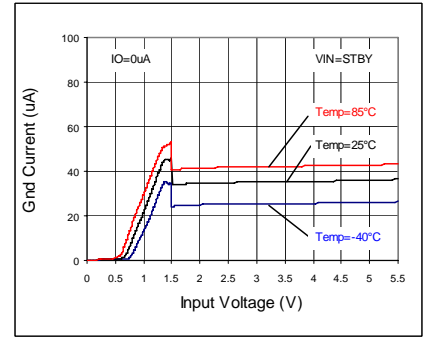

Fig 30. Circuit Current IGND

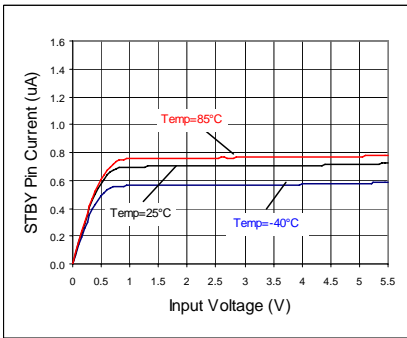

Fig 31. VSTBY - ISTBY

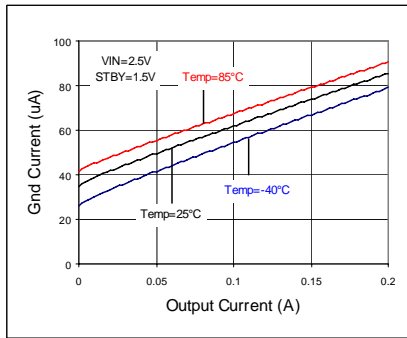

Fig 32. IOOUT - IIGND

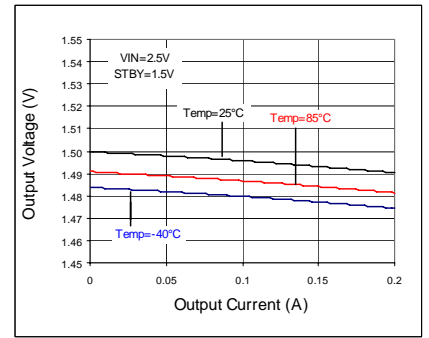

Fig 33. Load Regulation

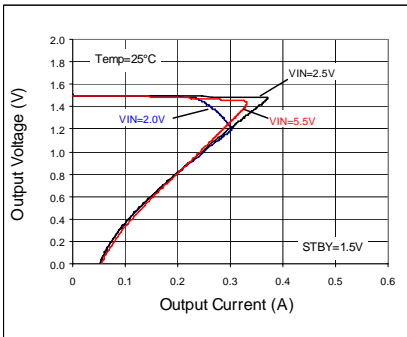

Fig 34. OCP Threshold

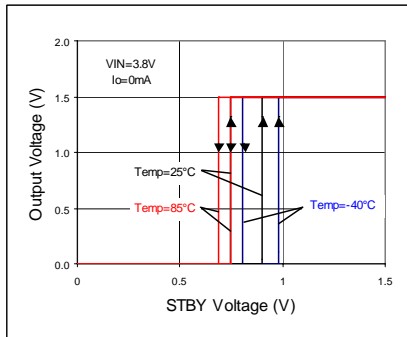

Fig 35. STBY Threshold

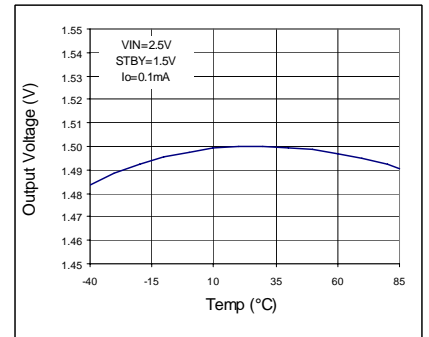

Fig 36. VOUT - Temp

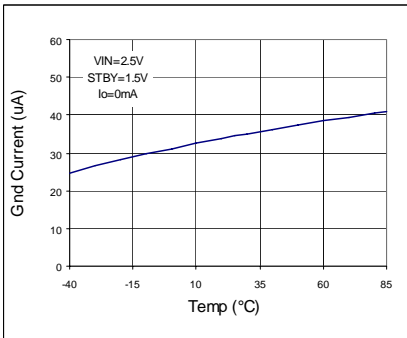

Fig 37. IIGND vs Temp

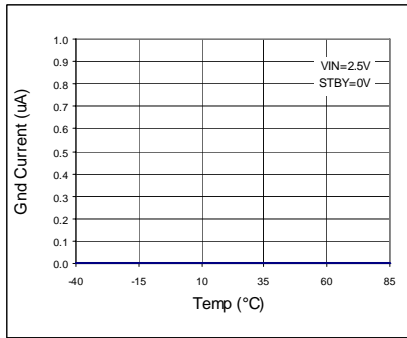

Fig 38. IIGND vs Temp (STBY)

● Reference data BU15TD2WNVX (Ta=25°C unless otherwise specified.)

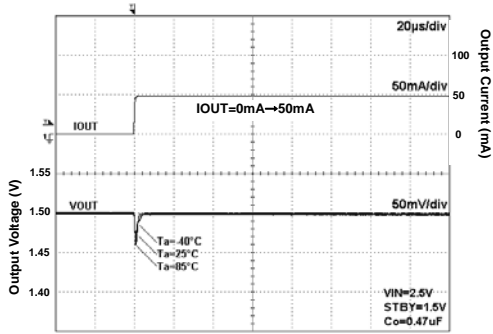

Fig 39. Load Response

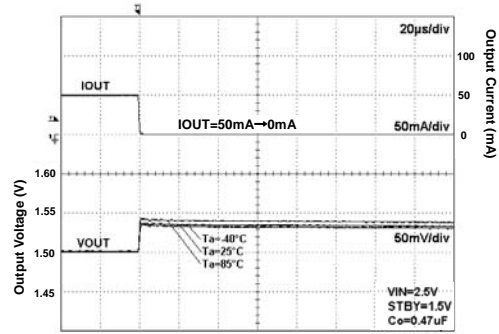

Fig 40. Load Response

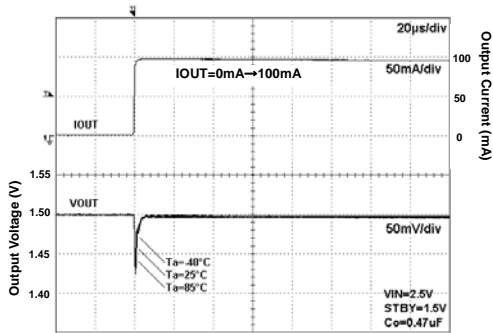

Fig 41. Load Response

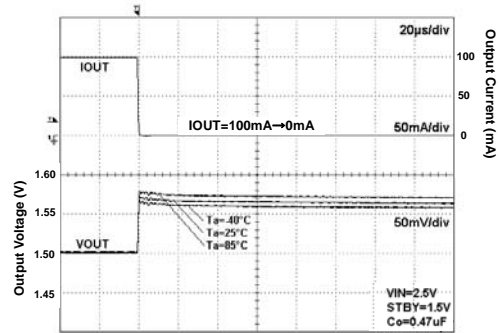

Fig 42. Load Response

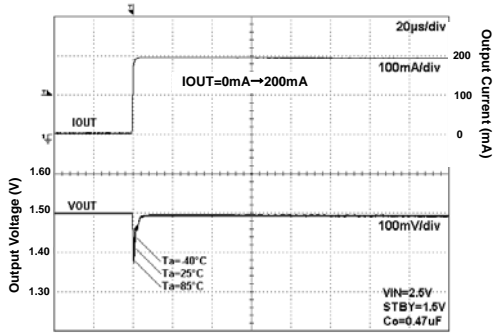

Fig 43. Load Response

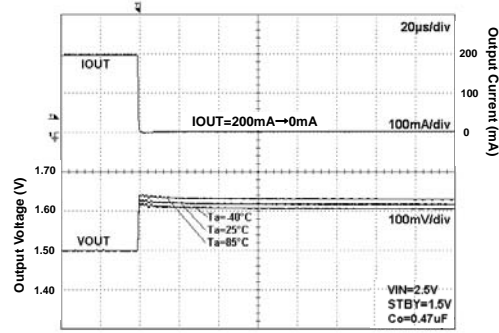

Fig 44. Load Response

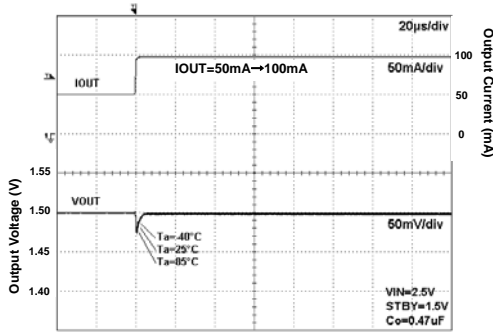

Fig 45. Load Response

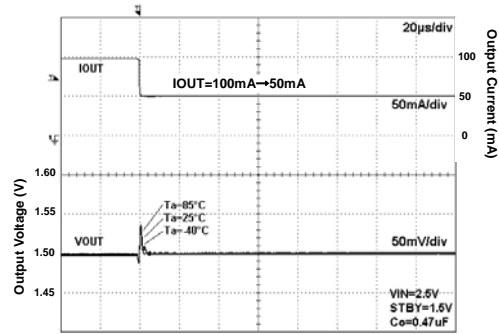

Fig 46. Load Response

●Reference data BU15TD2WNVX (Ta=25°C unless otherwise specified.)

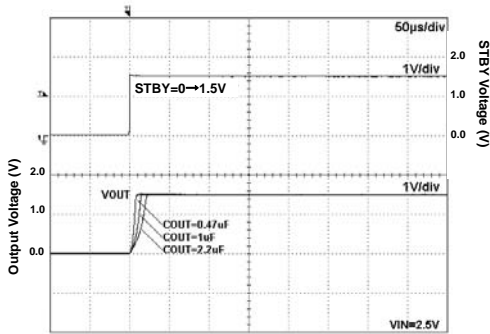

Fig 47. Start Up Time
Iout=0mA

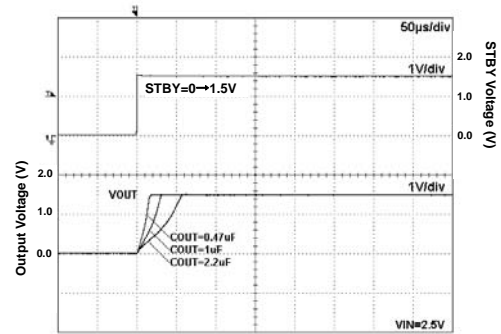

Fig 48. Start Up Time
Iout=200mA

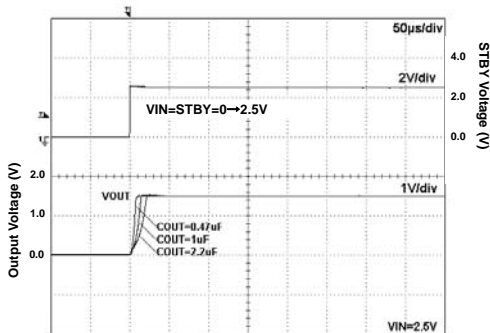

Fig 49. Start Up Time
(VIN=STBY) Iout=0mA
Iout=0mA

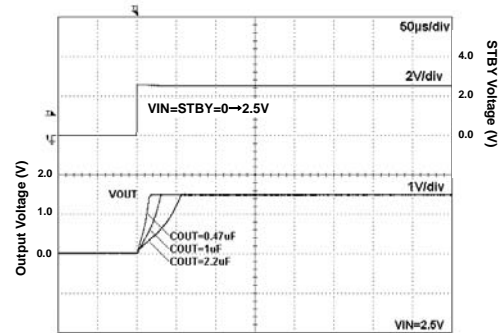

Fig 50. Start Up Time
(VIN=STBY) Iout=200mA

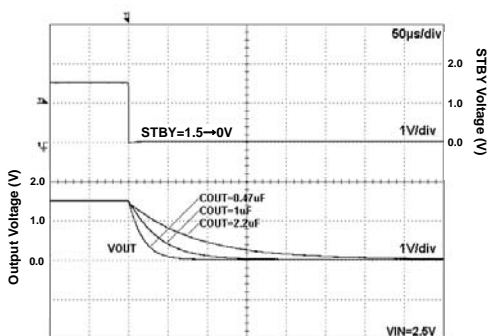

Fig 51. Discharge Time

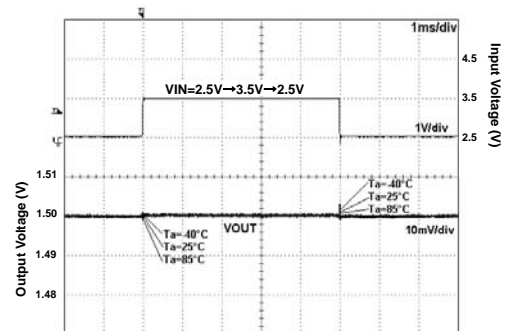

Fig 52. VIN Response

●Reference data BU18TD2WNVX (Ta=25°C unless otherwise specified.)

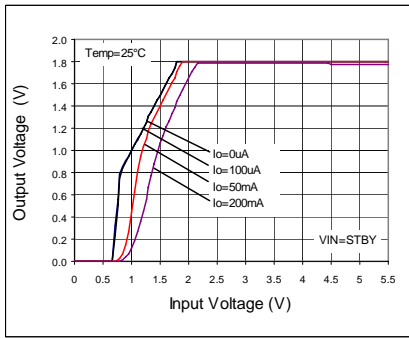

Fig 53. Output Voltage

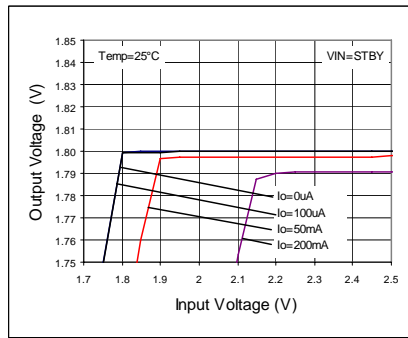

Fig 54. Line Regulation

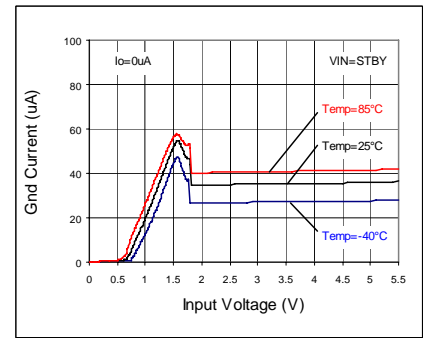

Fig 55. Circuit Current IGND

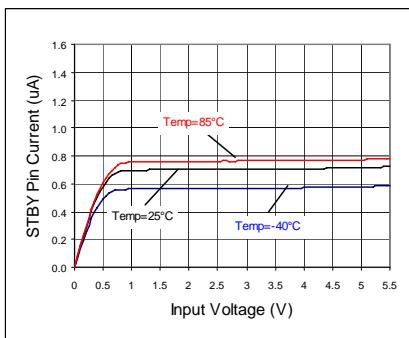

Fig 56. VSTBY - ISTBY

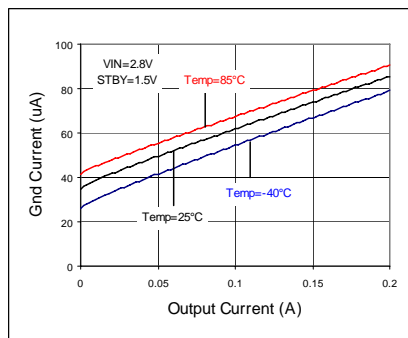

Fig 57. IOU - IGND

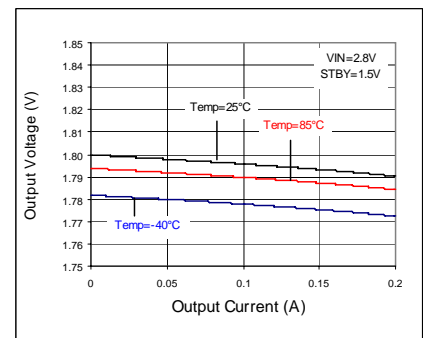

Fig 58. Load Regulation

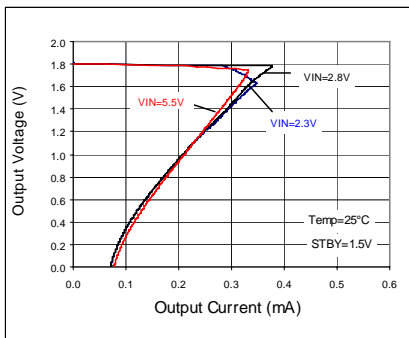

Fig 59. OCP Threshold

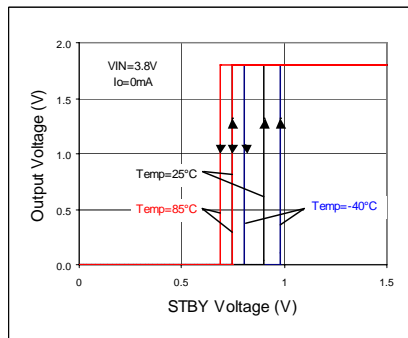

Fig 60. STBY Threshold

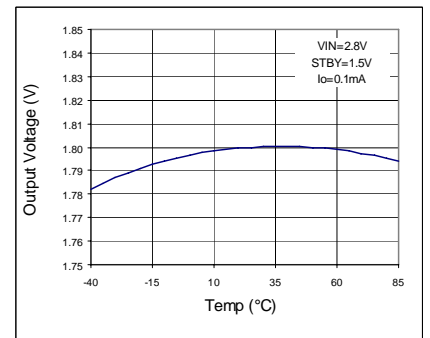

Fig 61. VOUT - Temp

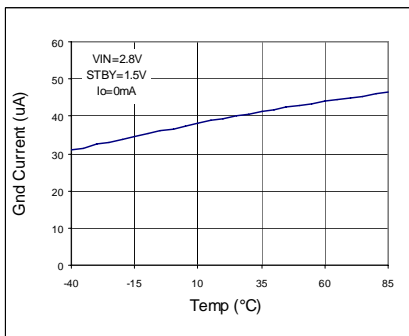

Fig 62. IGND - Temp

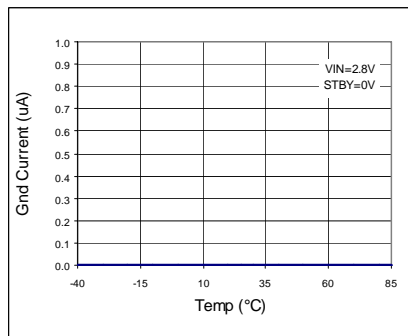

Fig 63. IGND - Temp (STBY)

● Reference data BU18TD2WNVX (Ta=25°C unless otherwise specified.)

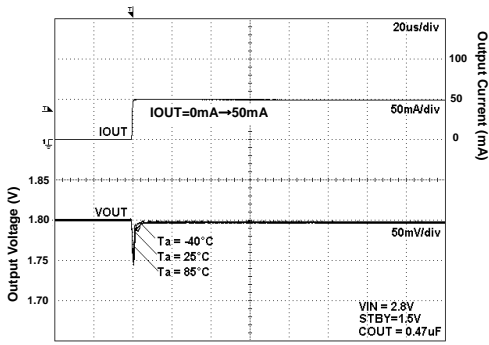

Fig 64. Load Response

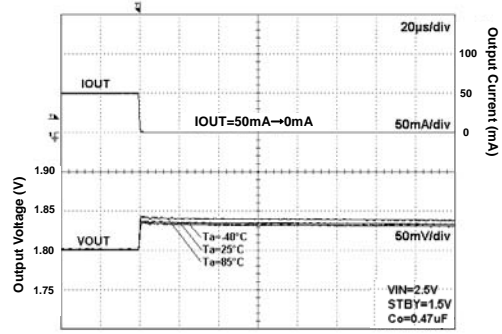

Fig 65. Load Response

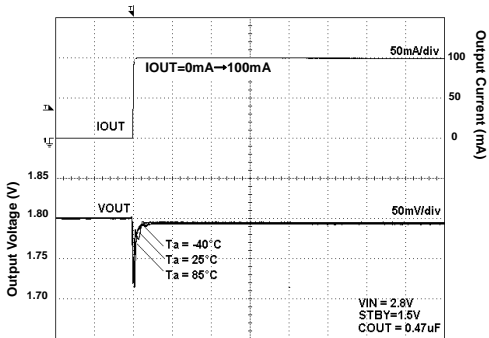

Fig 66. Load Response

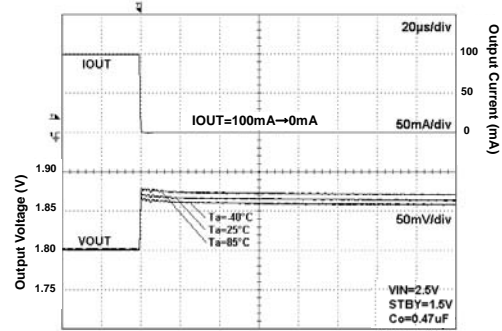

Fig 67. Load Response

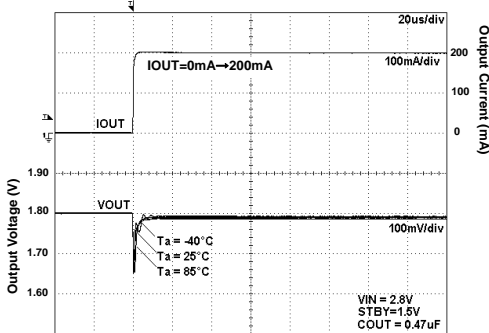

Fig 68. Load Response

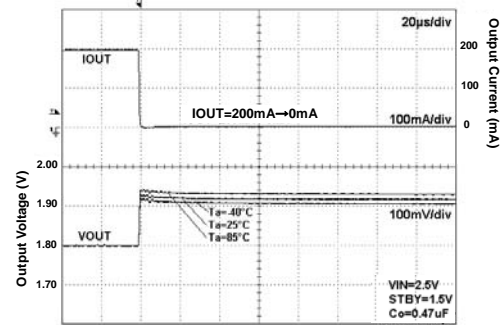

Fig 69. Load Response

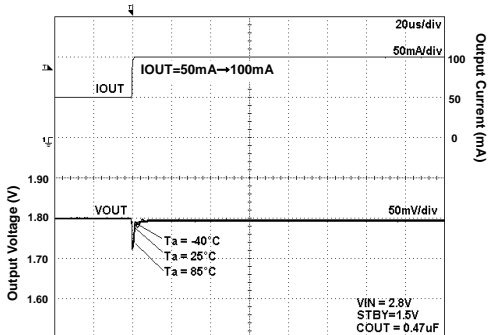

Fig 70. Load Response

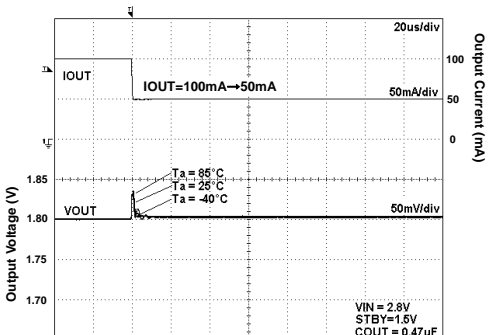

Fig 71. Load Response

●Reference data BU18TD2WNVX (Ta=25°C unless otherwise specified.)

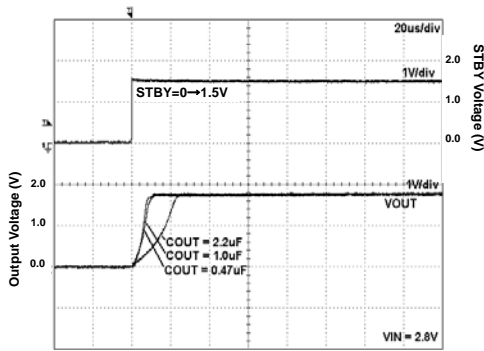

Fig 72. Start Up Time
Iout=0mA

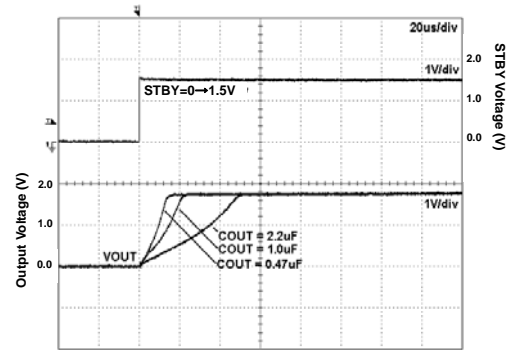

Fig 73. Start Up Time
Iout=200mA

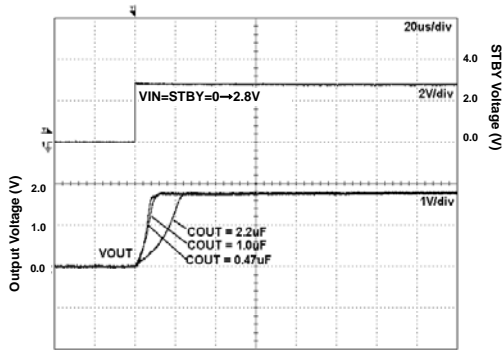

Fig 74. Start Up Time
(VIN=STBY) Iout=0mA
Iout=0mA

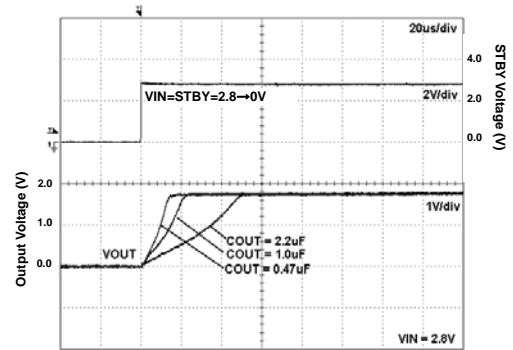

Fig 75. Start Up Time
(VIN=STBY) Iout=200mA

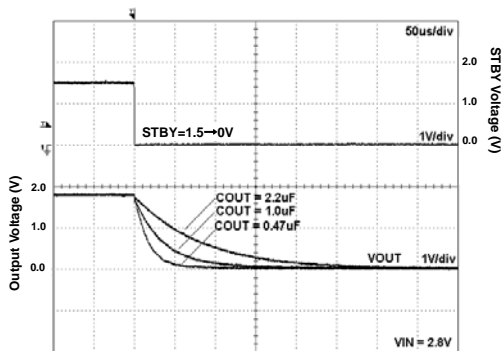

Fig 76. Discharge Time

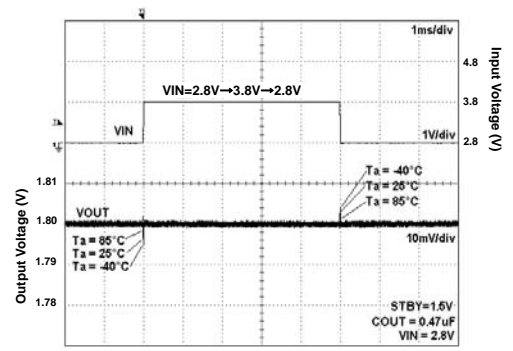

Fig 77. VIN Response

●Reference data BU19TD2WNVX (Ta=25°C unless otherwise specified.)

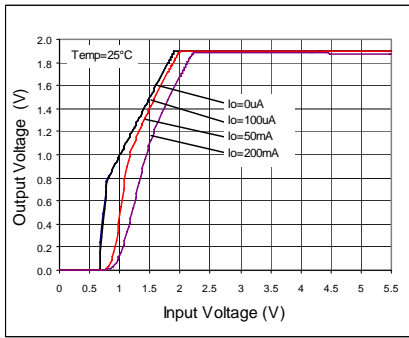

Fig 78. Output Voltage

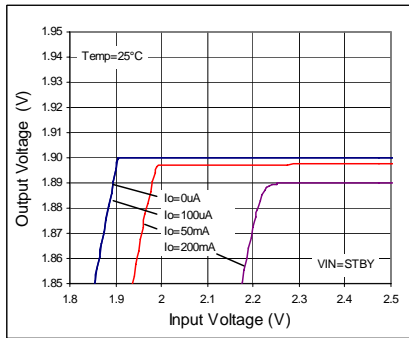

Fig 79. Line Regulation

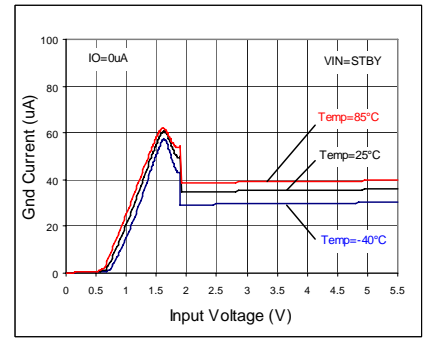

Fig 80. Circuit Current IGND

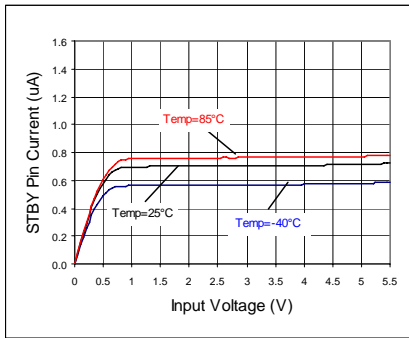

Fig 81. VSTBY - ISTBY

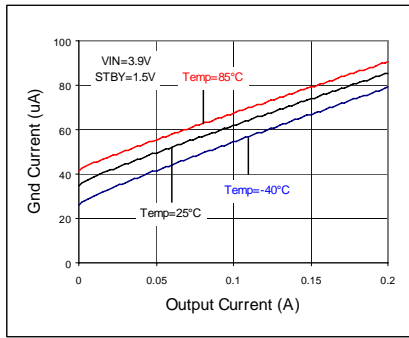

Fig 82. IOUT - IGDND

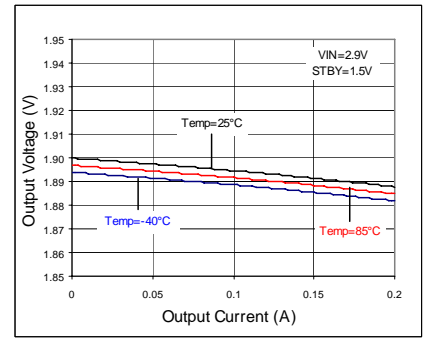

Fig 83. Load Regulation

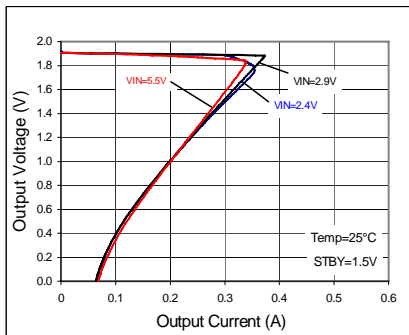

Fig 84. OCP Threshold

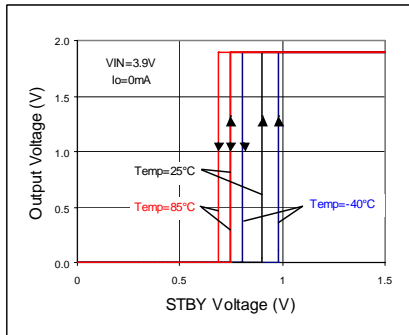

Fig 85. STBY Threshold

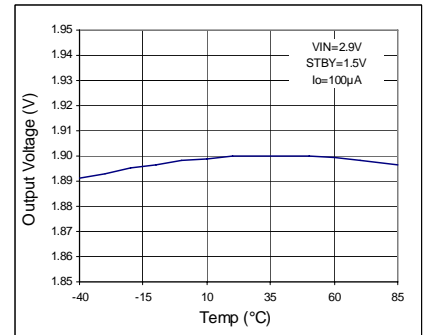

Fig 86. VOUT - Temp

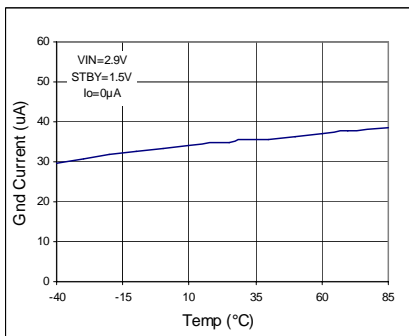

Fig 87. IGDND - Temp

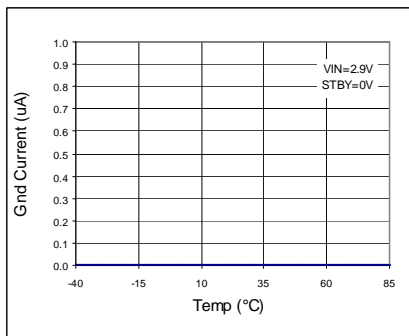

Fig 88. IGDND - Temp (STBY)

● Reference data BU19TD2WNVX (Ta=25°C unless otherwise specified.)

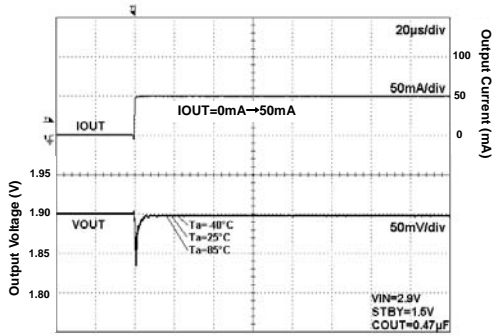

Fig 89. Load Response

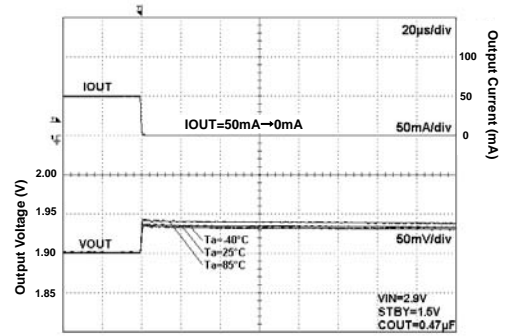

Fig 90. Load Response

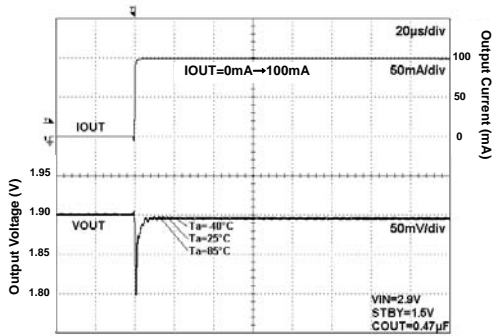

Fig 91. Load Response

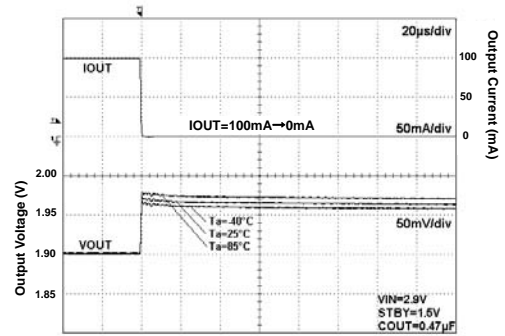

Fig 92. Load Response

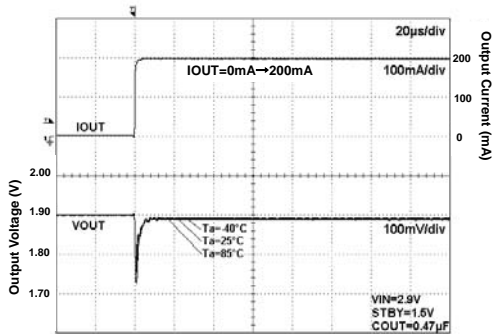

Fig 93. Load Response

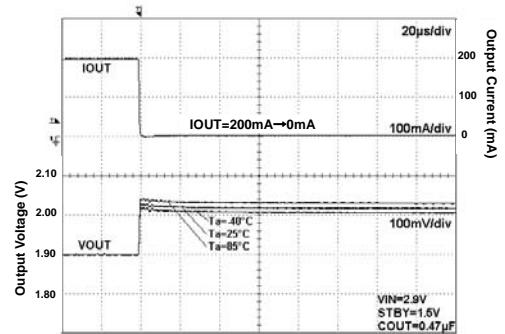

Fig 94. Load Response

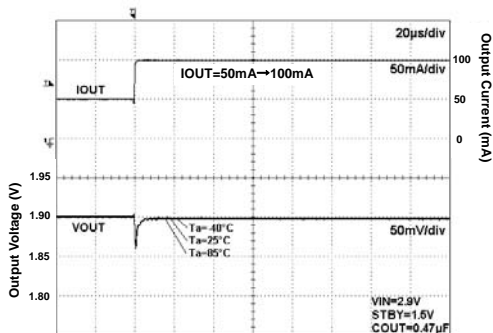

Fig 95. Load Response

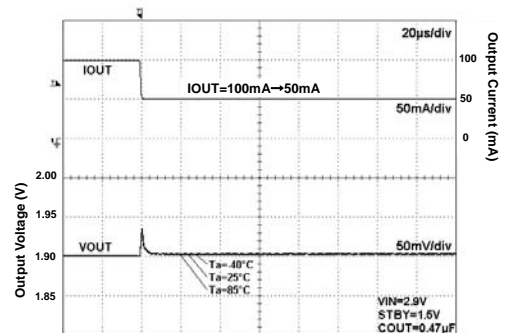

Fig 96. Load Response

●Reference data BU19TD2WNVX (Ta=25°C unless otherwise specified.)

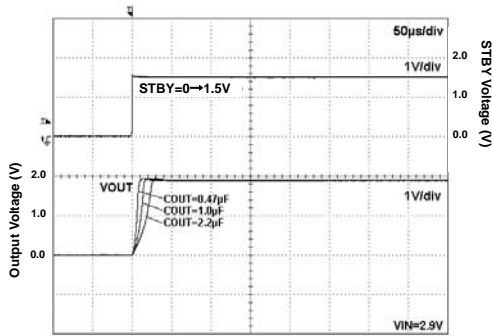

Fig 97. Start Up Time
Iout=0mA

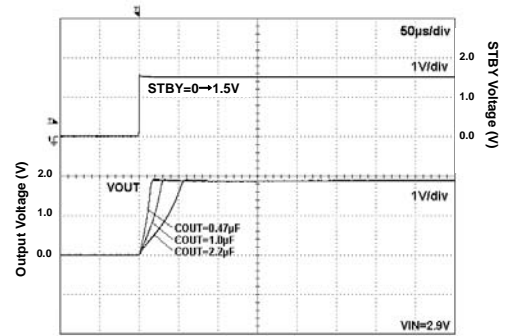

Fig 98. Start Up Time
Iout=200mA

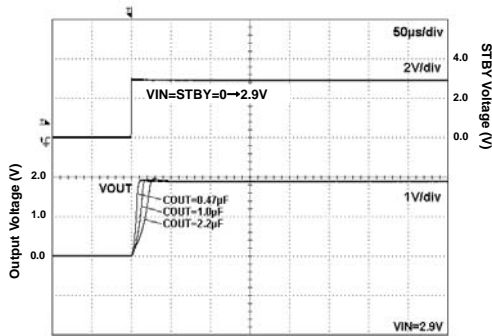

Fig 99. Start Up Time
(VIN=STBY) Iout=0mA
Iout=0mA

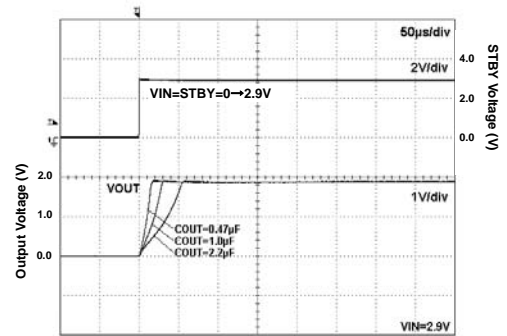

Fig 100. Start Up Time
(VIN=STBY) Iout=200mA

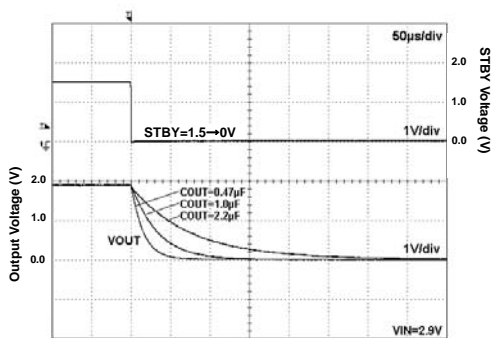

Fig 101. Discharge Time

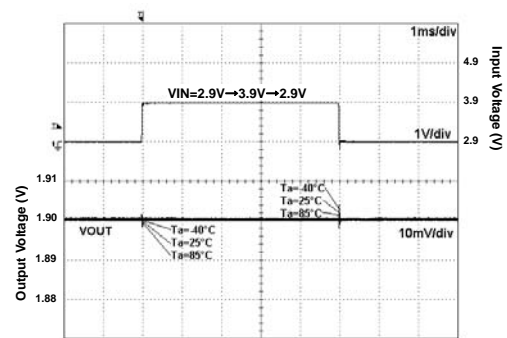

Fig 102. VIN Response

●Reference data BU25TD2WNVX (Ta=25°C unless otherwise specified.)

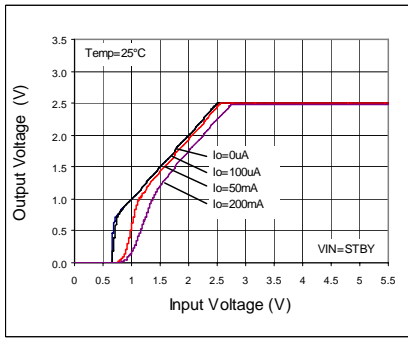

Fig 103. Output Voltage

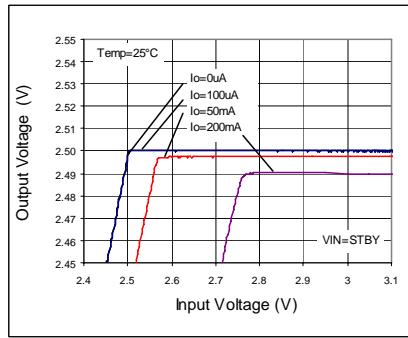

Fig 104. Line Regulation

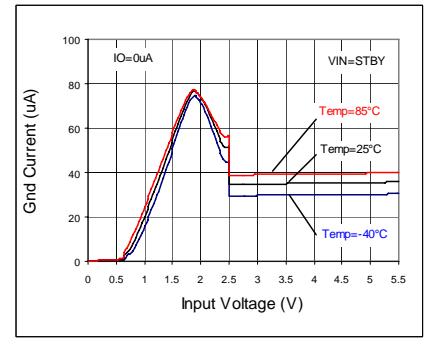

Fig 105. Circuit Current IGND

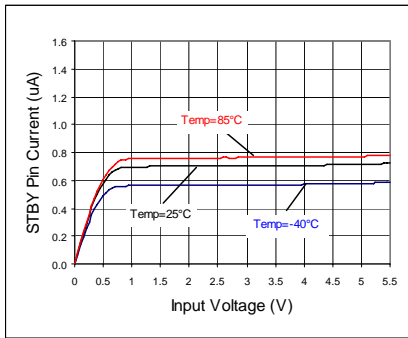

Fig 106. VSTBY - ISTBY

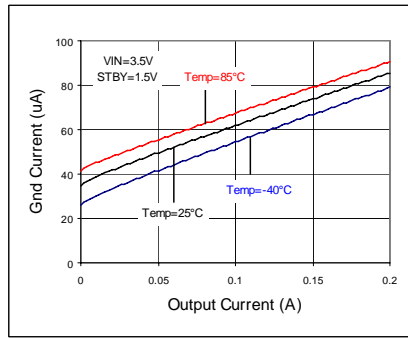

Fig 107. IOOUT - IGND

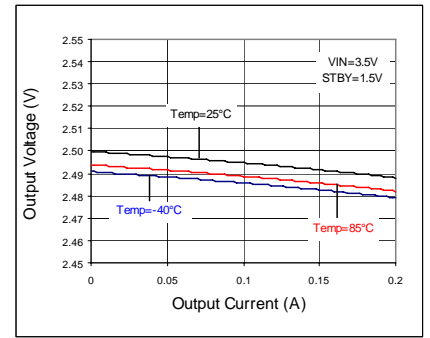

Fig 108. Load Regulation

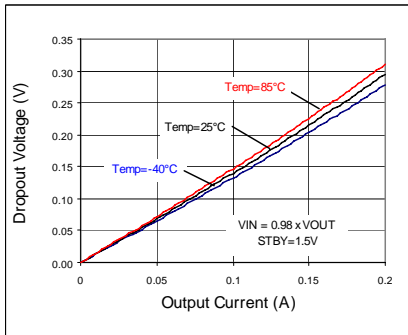

Fig 109. Dropout Voltage

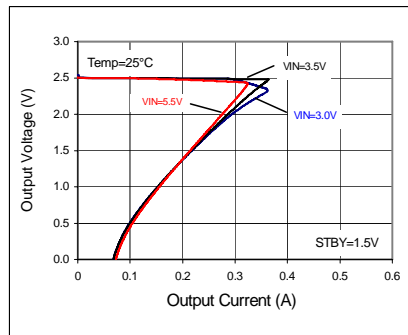

Fig 110. OCP Threshold

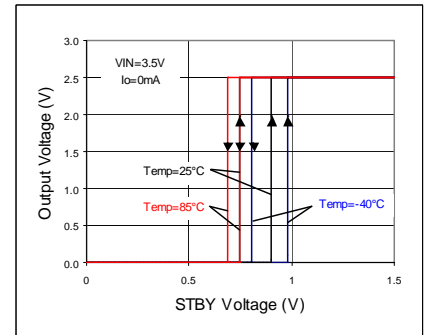

Fig 111. STBY Threshold

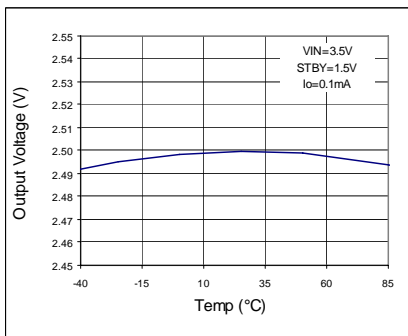

Fig 112. VOUT - Temp

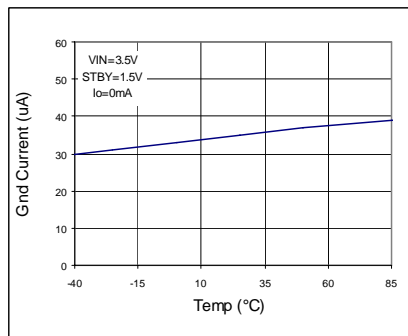

Fig 113. IGND - Temp

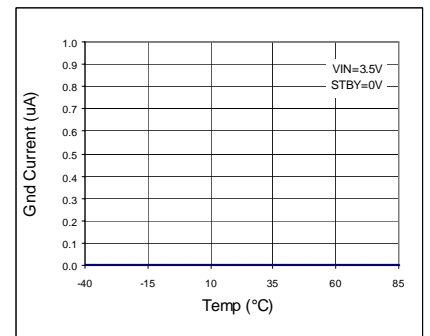

Fig 114. IGND - Temp (STBY)

●Reference data BU25TD2WNVX (Ta=25°C unless otherwise specified.)

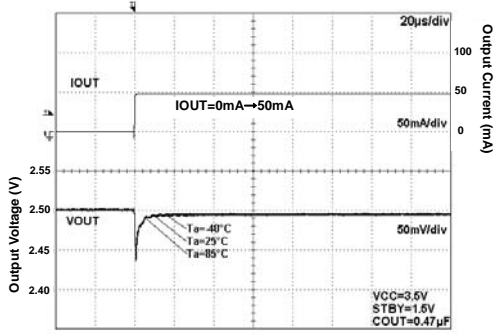

Fig 115. Load Response

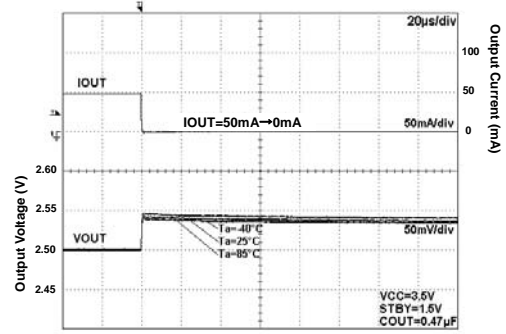

Fig 116. Load Response

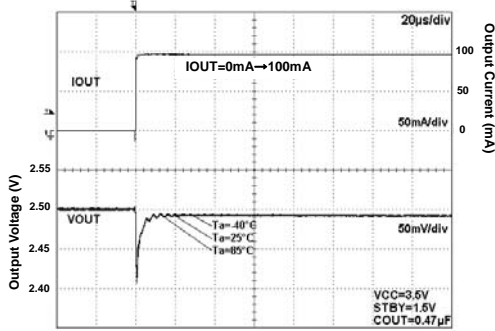

Fig 117. Load Response

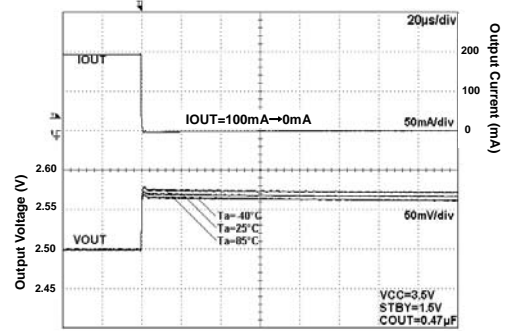

Fig 118. Load Response

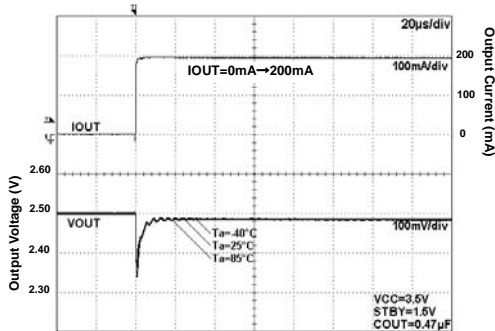

Fig 119. Load Response

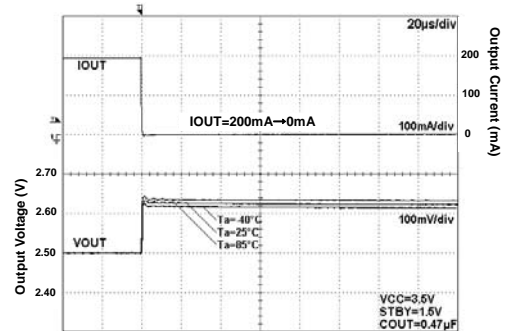

Fig 120. Load Response

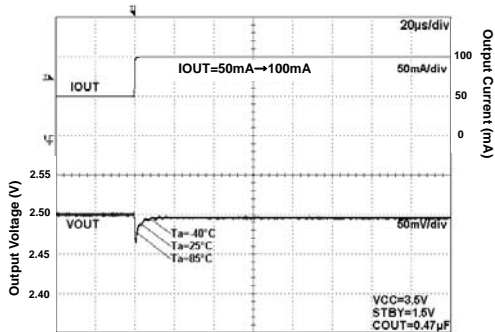

Fig 121. Load Response

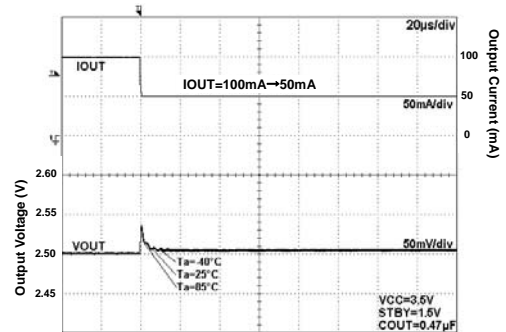

Fig 122. Load Response

●Reference data BU25TD2WNVX (Ta=25°C unless otherwise specified.)

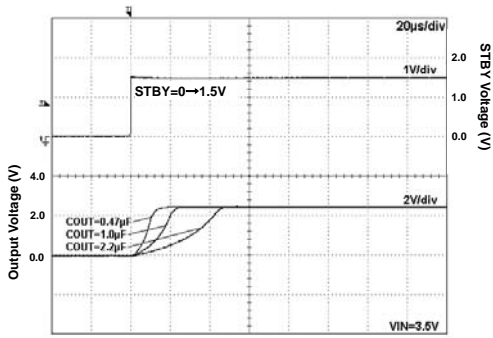

Fig 123. Start Up Time
Iout=0mA

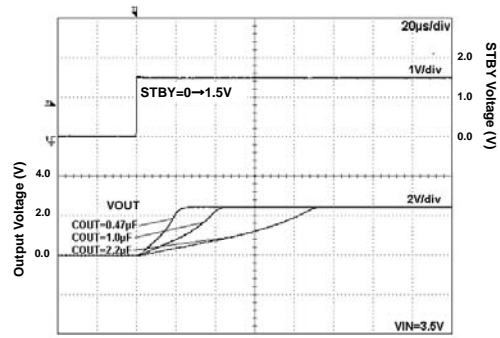

Fig 124. Start Up Time
Iout=200mA

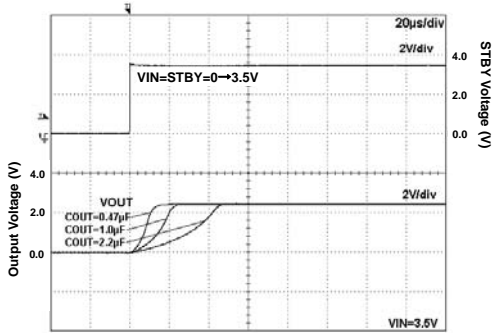

Fig 125. Start Up Time
(VIN=STBY) Iout=0mA
Iout=0mA

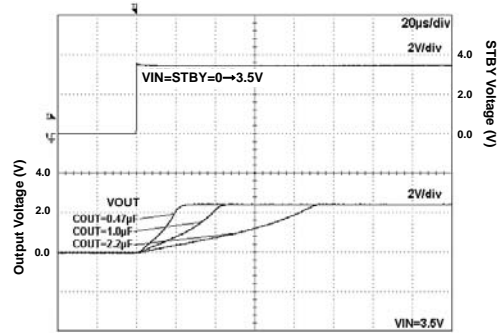

Fig 126. Start Up Time
(VIN=STBY) Iout=200mA

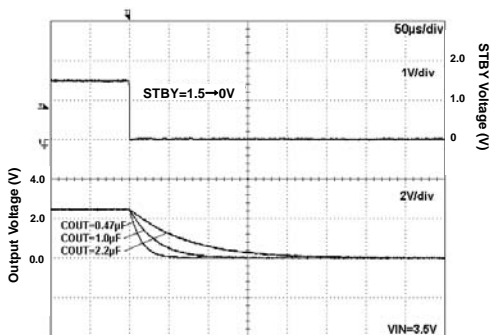

Fig 127. Discharge Time

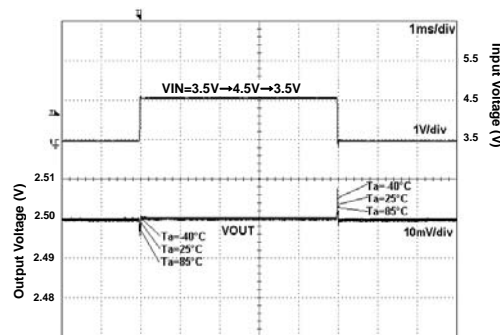

Fig 128. VIN Response

●Reference data BU26TD2WNVX (Ta=25°C unless otherwise specified.)

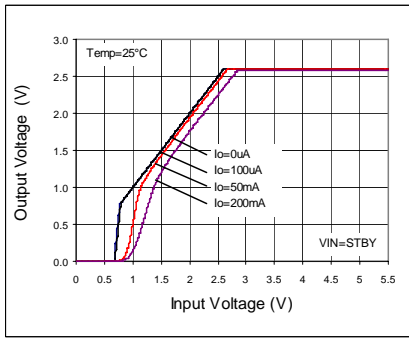

Fig 129. Output Voltage

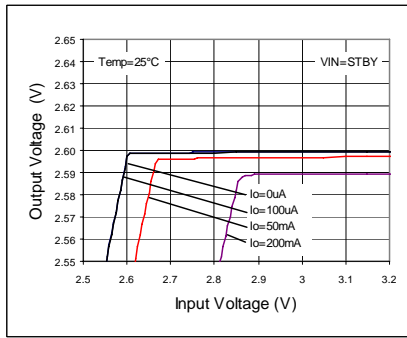

Fig 130. Line Regulation

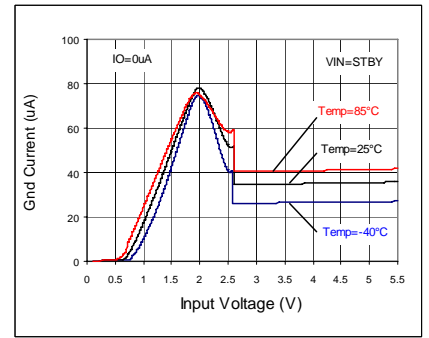

Fig 131. Circuit Current IGND

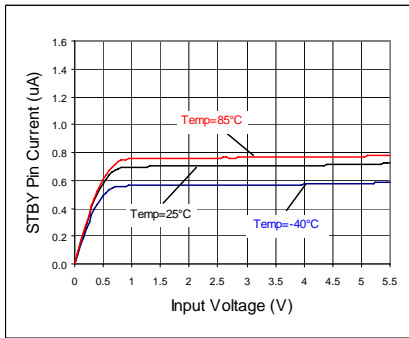

Fig 132. VSTBY - ISTBY

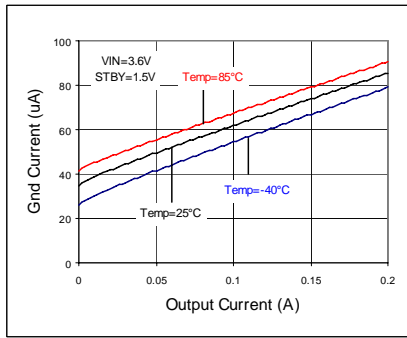

Fig 133. IOU - IGND

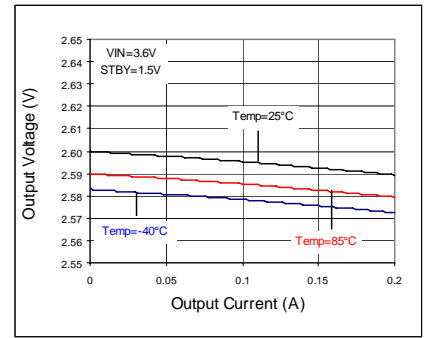

Fig 134. Load Regulation

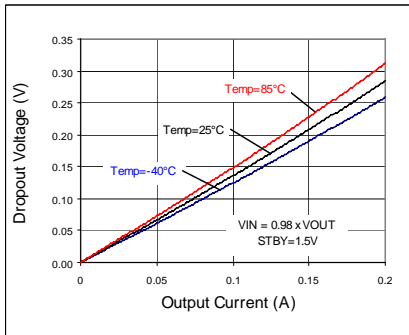

Fig 135. Dropout Voltage

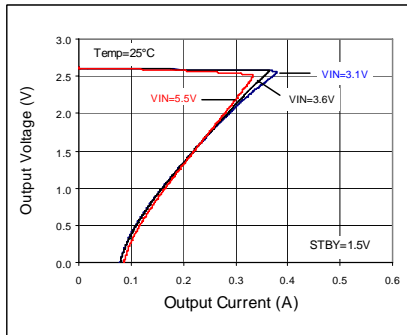

Fig 136. OCP Threshold

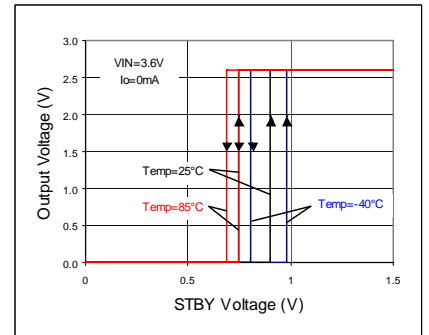

Fig 137. STBY Threshold

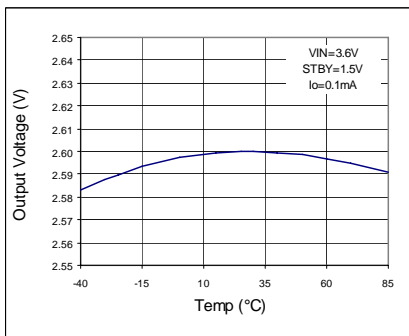

Fig 138. VOUT - Temp

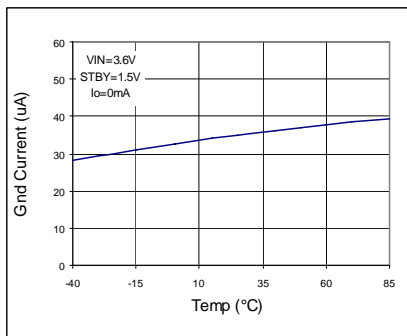

Fig 139. IGND - Temp

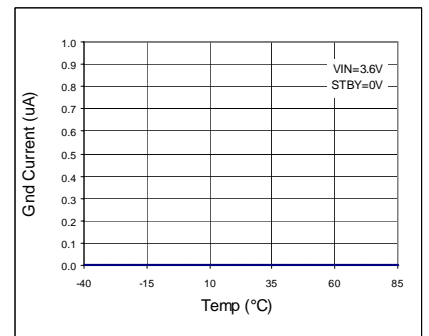

Fig 140. IGND - Temp (STBY)

● Reference data BU26TD2WNVX (Ta=25°C unless otherwise specified.)

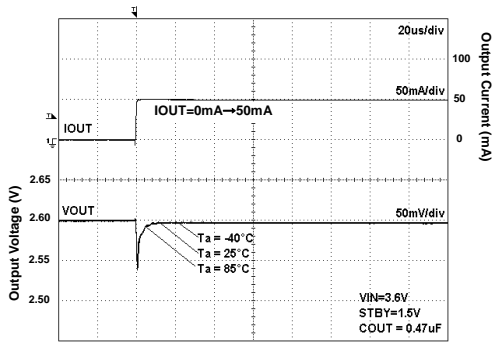

Fig 141. Load Response

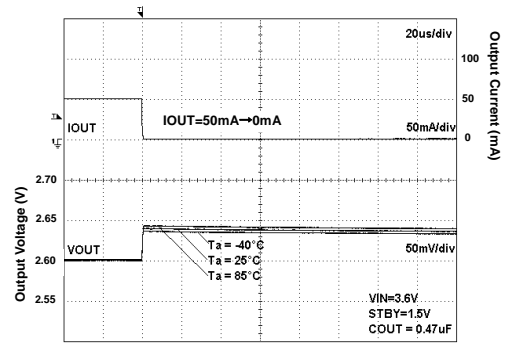

Fig 142. Load Response

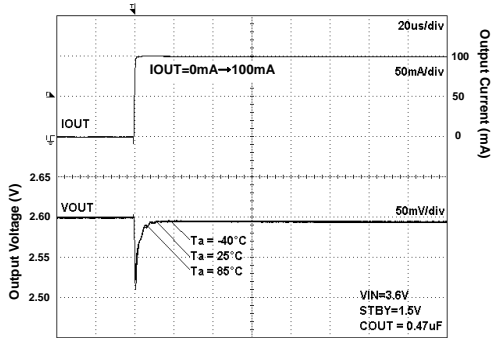

Fig 143. Load Response

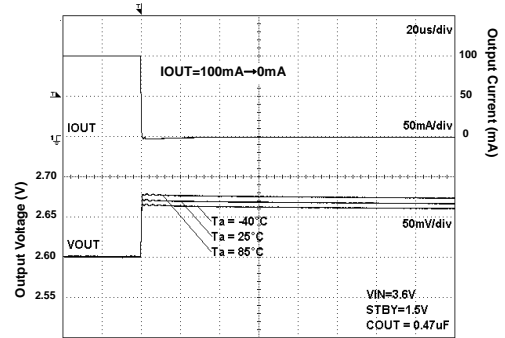

Fig 144. Load Response

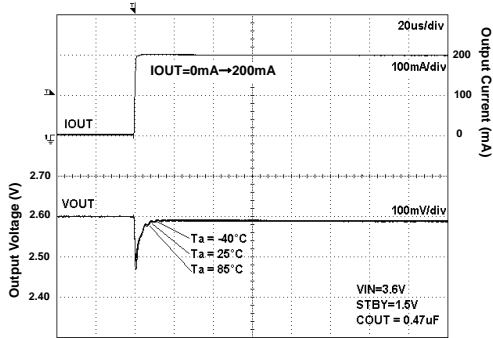

Fig 145. Load Response

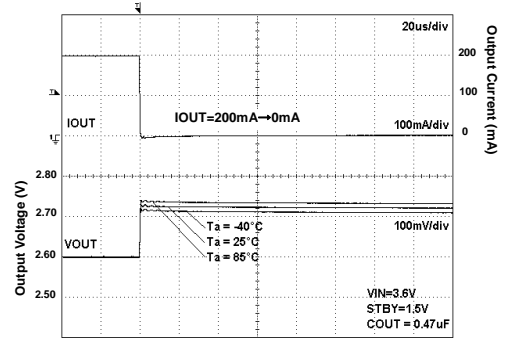

Fig 146. Load Response

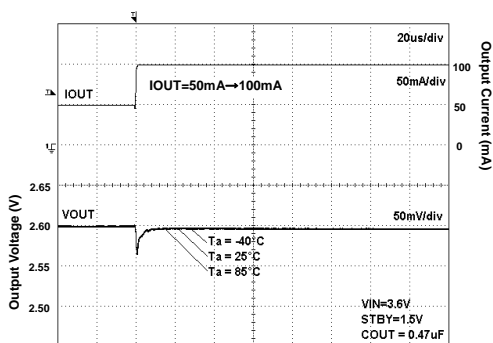

Fig 147. Load Response

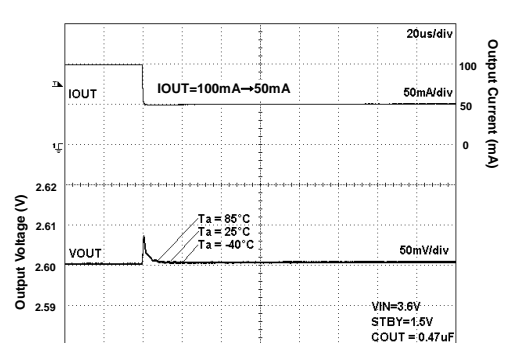

Fig 148. Load Response

●Reference data BU26TD2WNVX (Ta=25°C unless otherwise specified.)

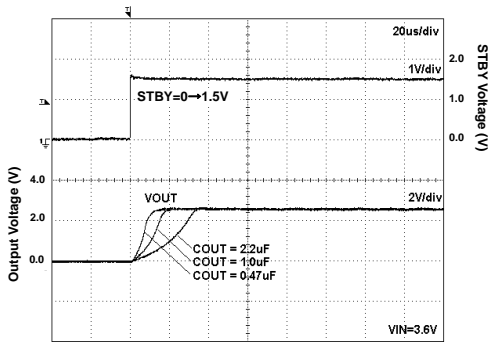

Fig 149. Start Up Time
Iout=0mA

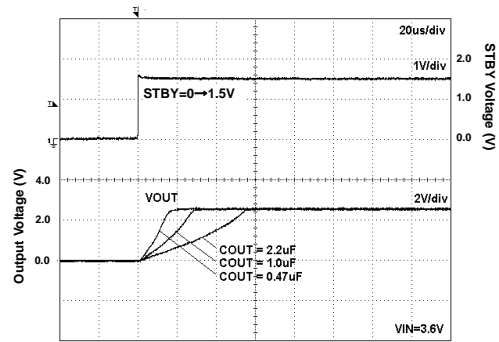

Fig 150. Start Up Time
Iout=200mA

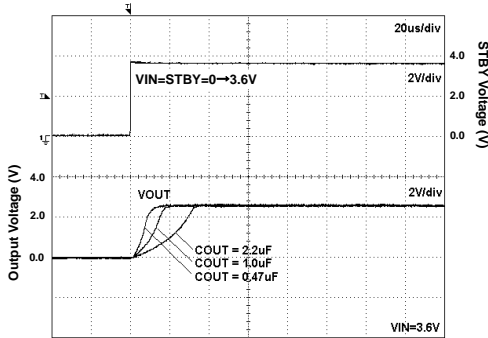

Fig 151. Start Up Time
(VIN=STBY) Iout=0mA
Iout=0mA

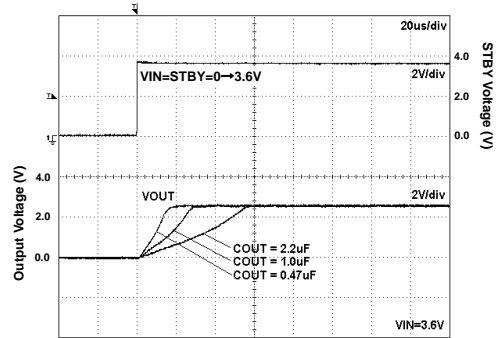

Fig 152. Start Up Time
(VIN=STBY) Iout=200mA

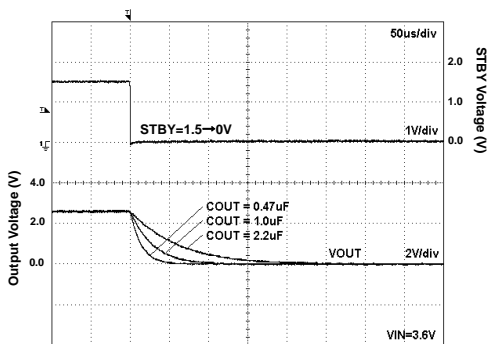

Fig 153. Discharge Time

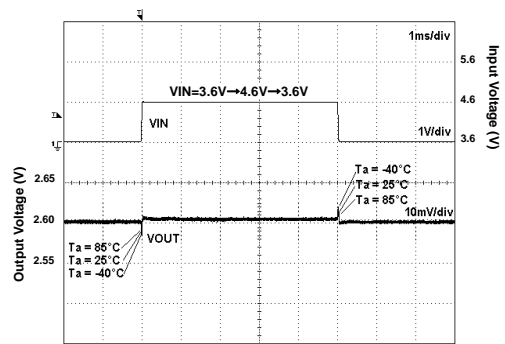

Fig 154. VIN Response

●Reference data BU27TD2WNVX (Ta=25°C unless otherwise specified.)

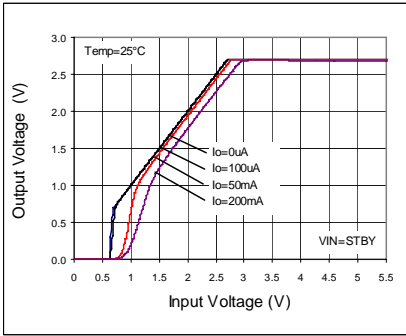

Fig 155. Output Voltage

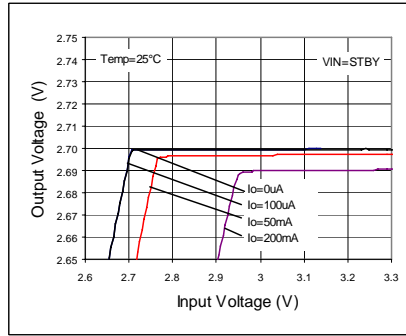

Fig 156. Line Regulation

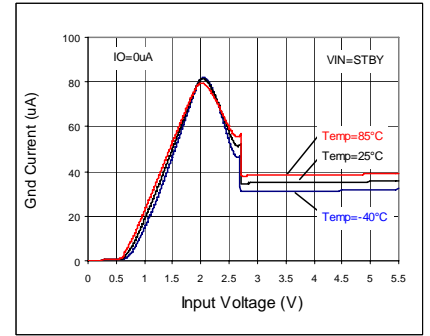

Fig 157. Circuit Current IGND

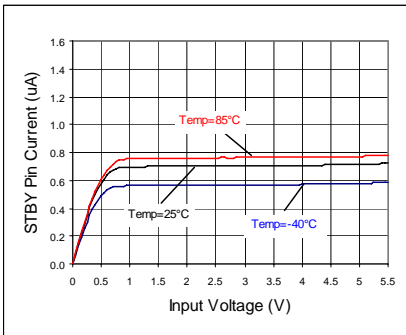

Fig 158. VSTBY - ISTBY

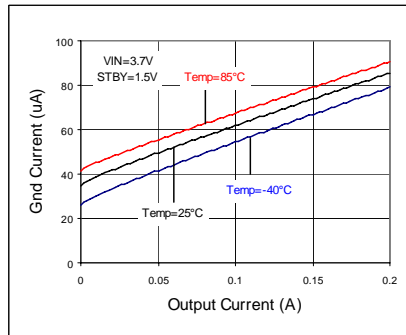

Fig 159. IOUT - IGND

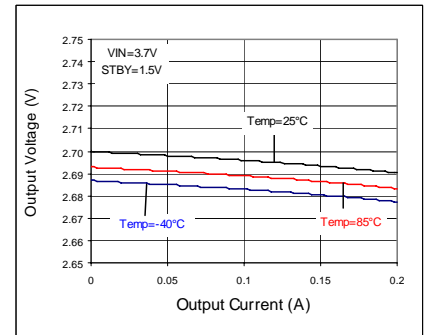

Fig 160. Load Regulation

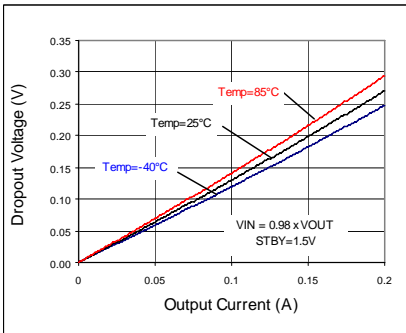

Fig 161. Dropout Voltage

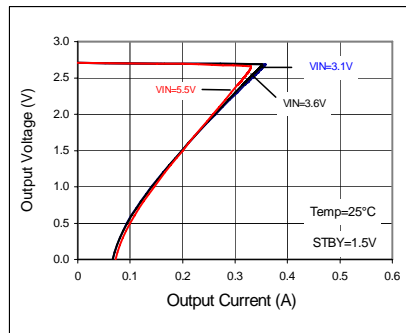

Fig 162. OCP Threshold

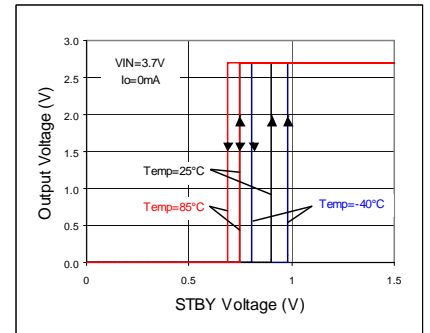

Fig 163. STBY Threshold

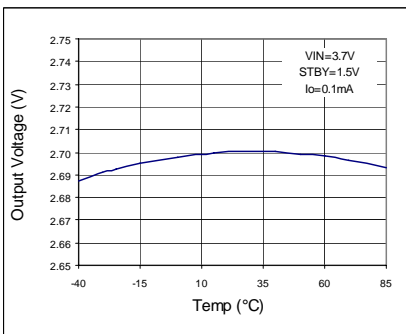

Fig 164. VOUT - Temp

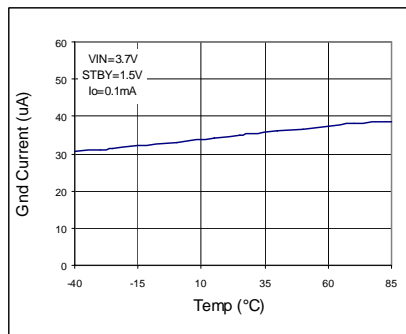

Fig 165. IGND - Temp

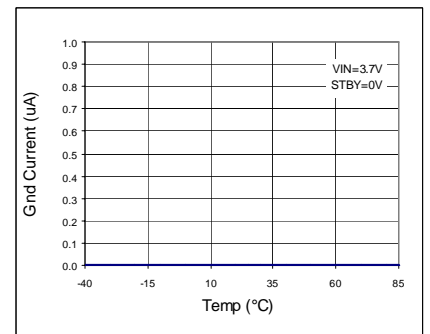

Fig 166. IGND - Temp (STBY)

●Reference data BU27TD2WNVX (Ta=25°C unless otherwise specified.)

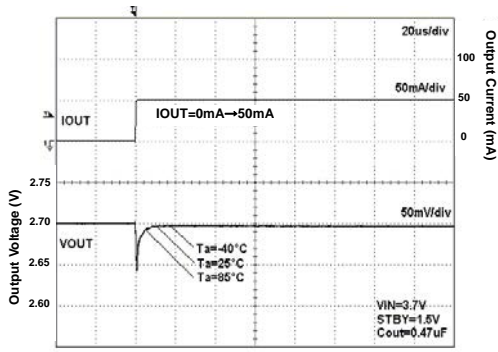

Fig 167. Load Response

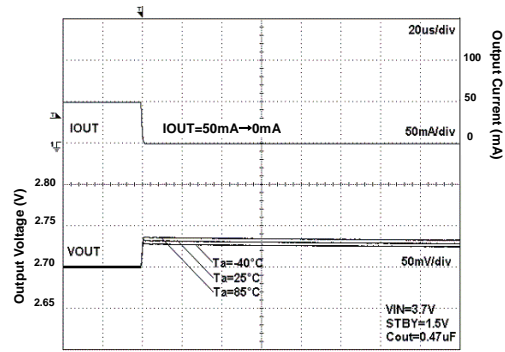

Fig 168. Load Response

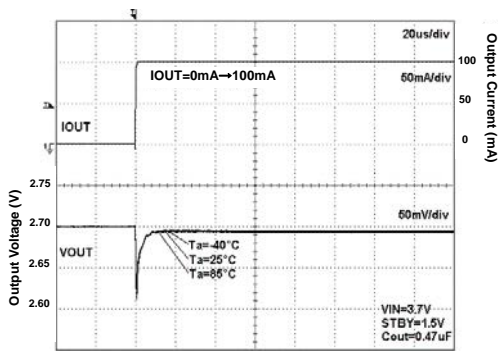

Fig 169. Load Response

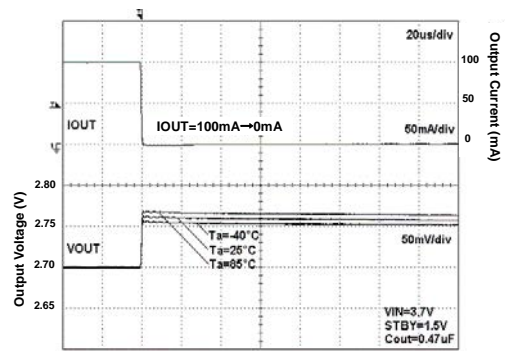

Fig 170. Load Response

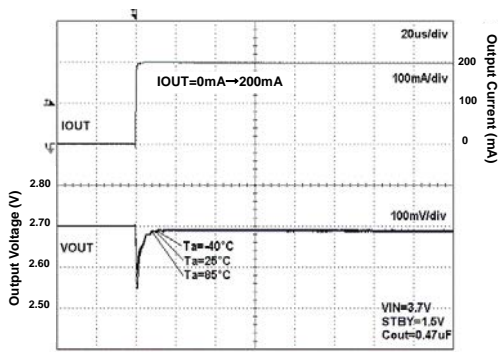

Fig 171. Load Response

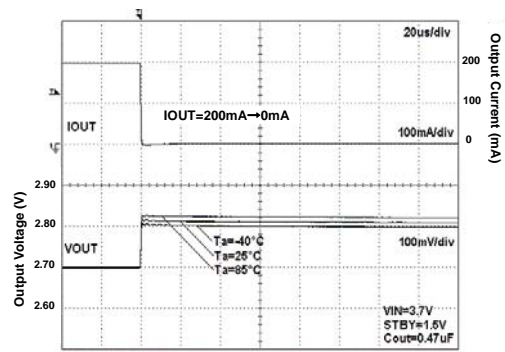

Fig 172. Load Response

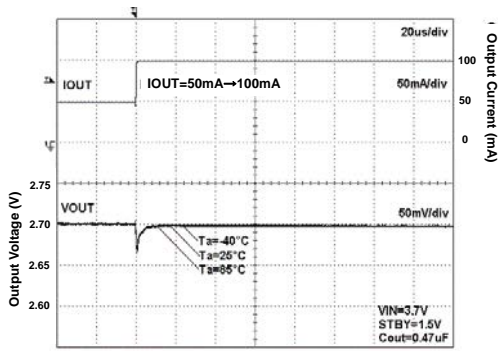

Fig 173. Load Response

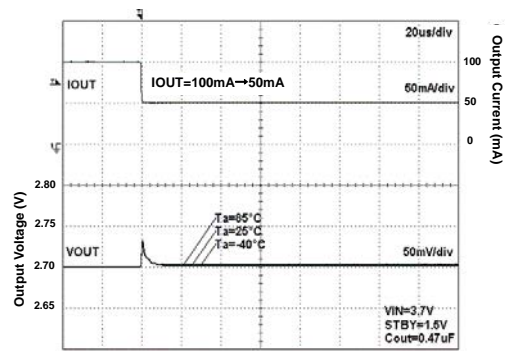
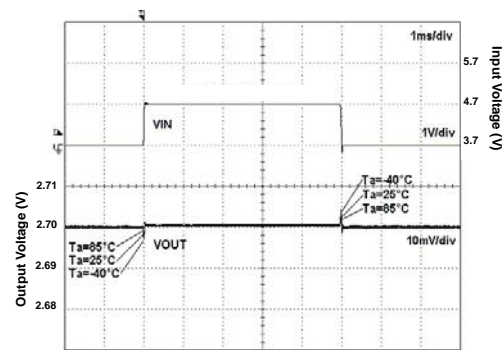
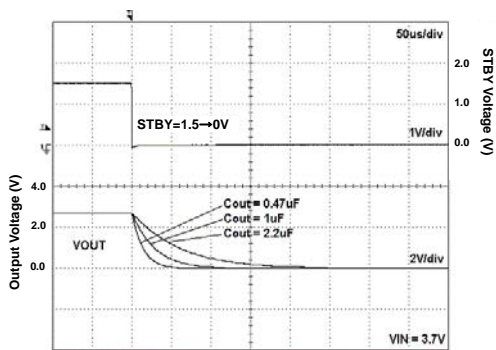
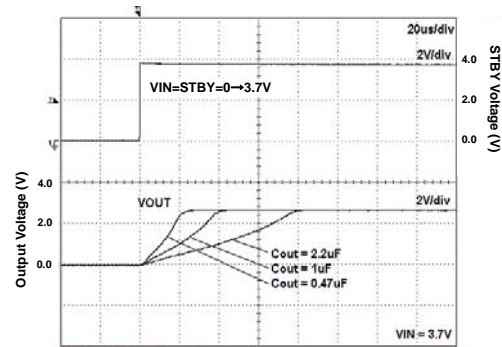
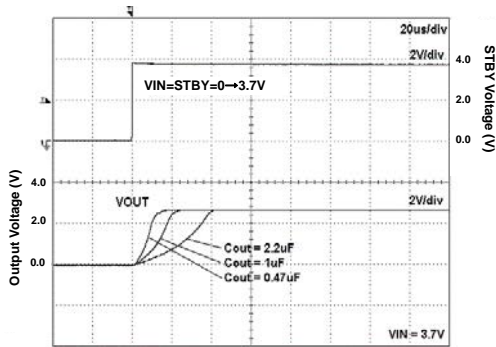
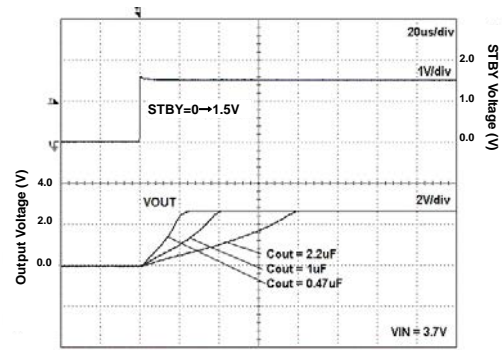
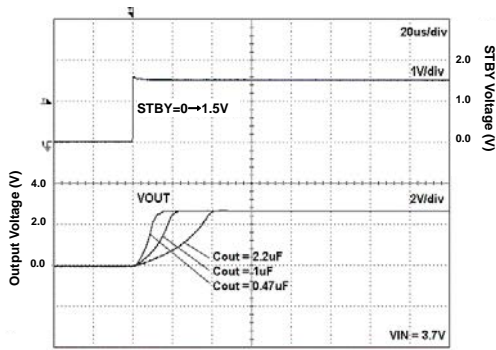

Fig 174. Load Response

●Reference data BU27TD2WNVX (Ta=25°C unless otherwise specified.)



●Reference data BU28TD2WNVX (Ta=25°C unless otherwise specified.)

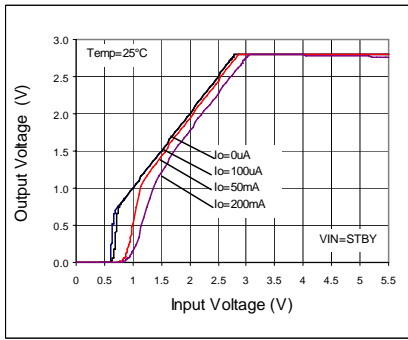

Fig 181. Output Voltage

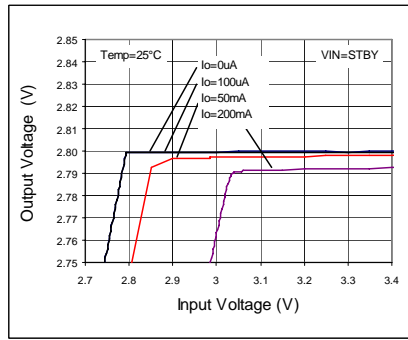

Fig 182. Line Regulation

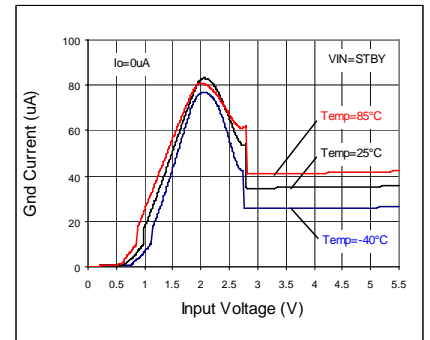

Fig 183. Circuit Current IGND

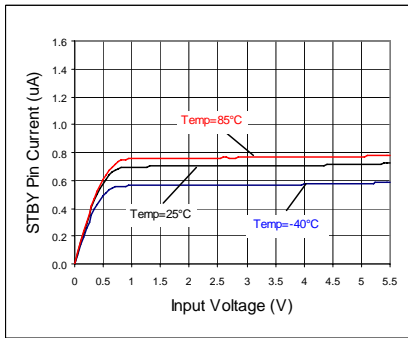

Fig 184. VSTBY - ISTBY

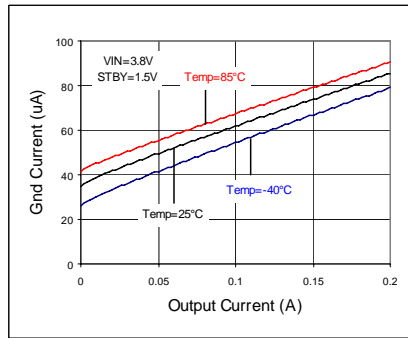

Fig 185. IOOUT - IGND

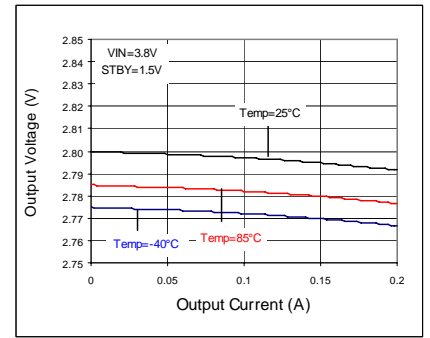

Fig 186. Load Regulation

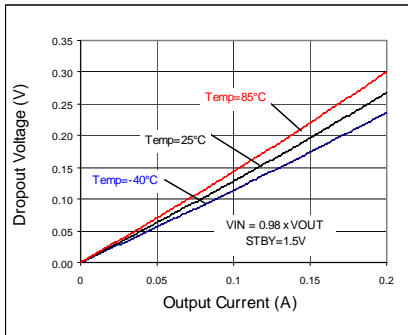

Fig 187. Dropout Voltage

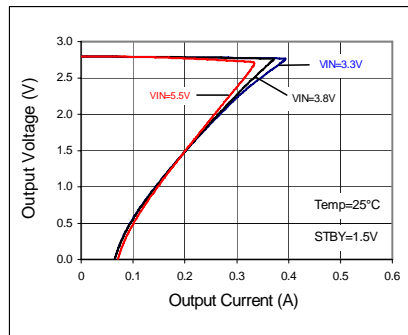

Fig 188. OCP Threshold

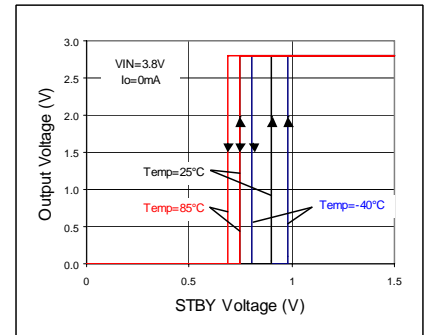

Fig 189. STBY Threshold

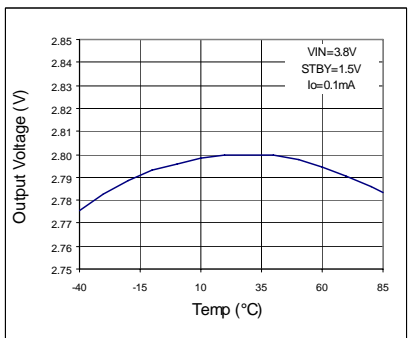

Fig 190. VOUT - Temp

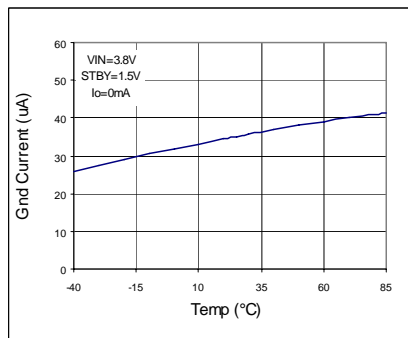

Fig 191. IGND - Temp

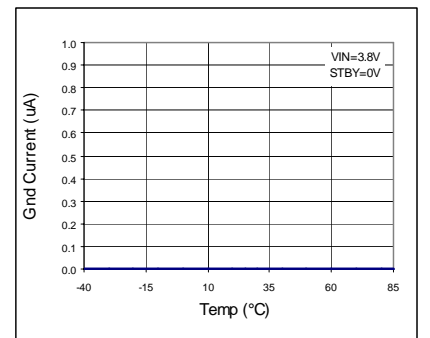

Fig 192. IGND - Temp (STBY)

●Reference data BU28TD2WNVX (Ta=25°C unless otherwise specified.)

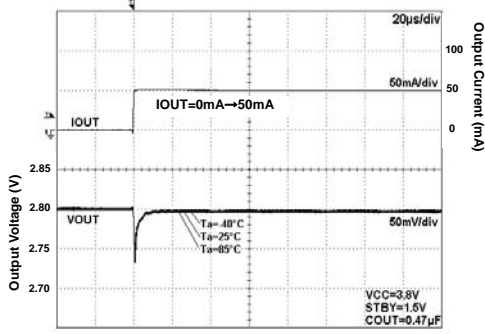

Fig 193. Load Response

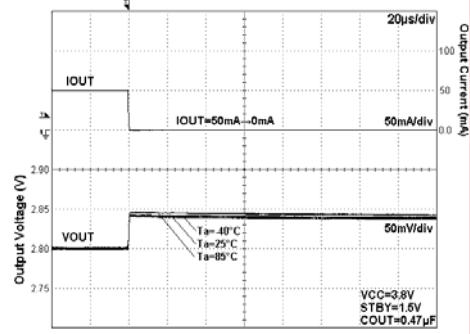

Fig 194. Load Response

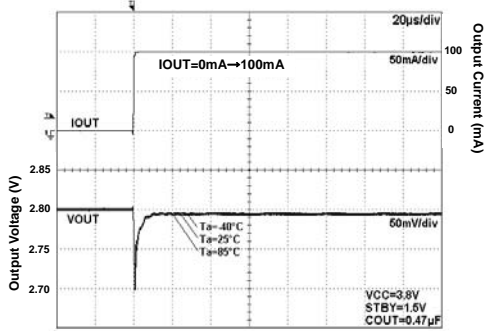

Fig 195. Load Response

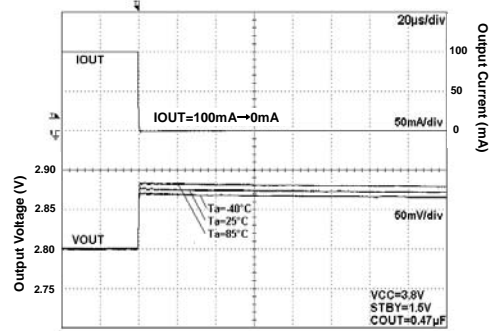

Fig 196. Load Response

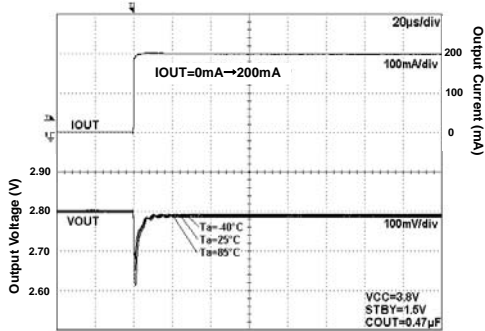

Fig 197. Load Response

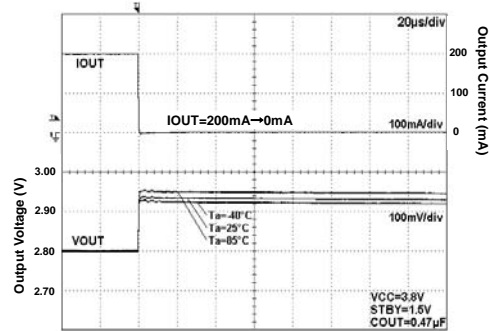

Fig 198. Load Response

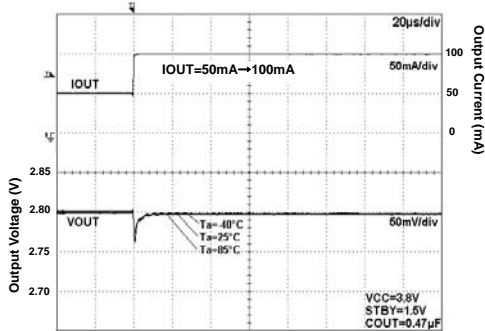

Fig 199. Load Response

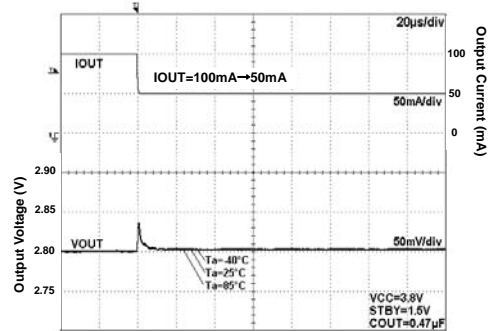

Fig 200. Load Response

●Reference data BU28TD2WNVX (Ta=25°C unless otherwise specified.)

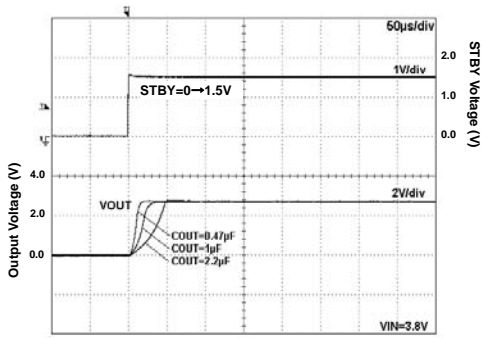

Fig 201. Start Up Time
Iout=0mA

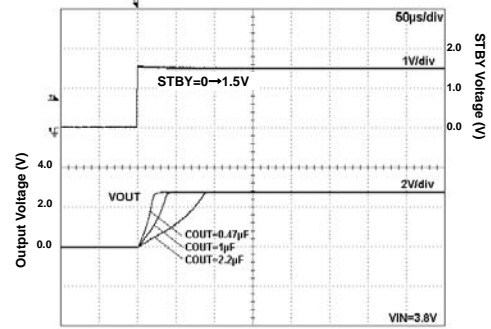

Fig 202. Start Up Time
Iout=200mA

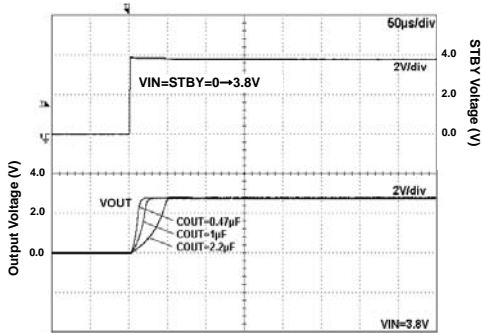

Fig 203. Start Up Time
(VIN=STBY) Iout=0mA

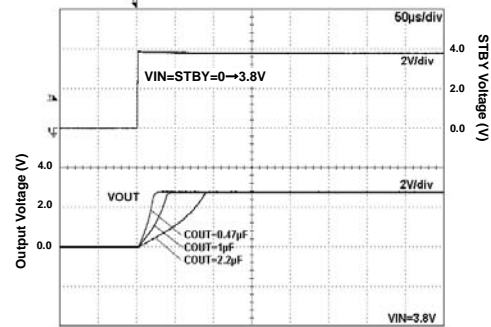

Fig 204. Start Up Time
(VIN=STBY) Iout=200mA

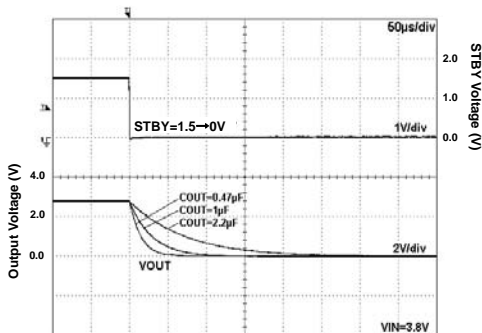

Fig 205. Discharge Time

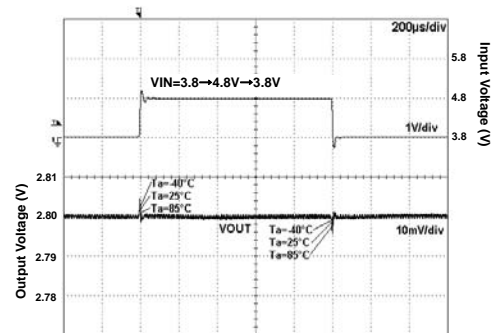

Fig 206. VIN Response

●Reference data BU30TD2WNVX (Ta=25°C unless otherwise specified.)

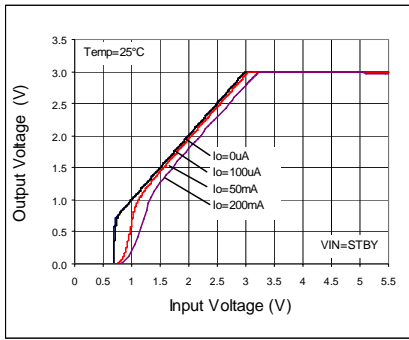

Fig 207. Output Voltage

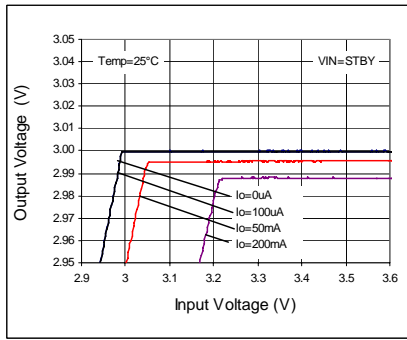

Fig 208. Line Regulation

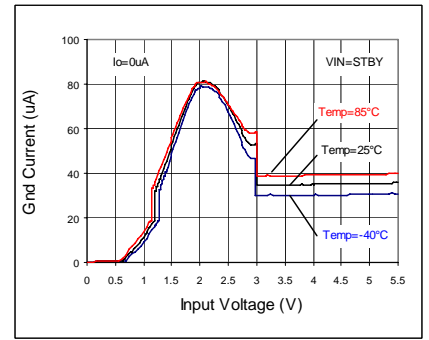

Fig 209. Circuit Current IGND

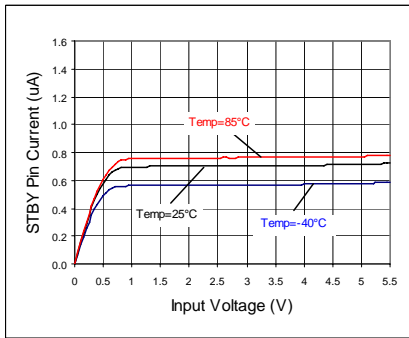

Fig 210. VSTBY - ISTBY

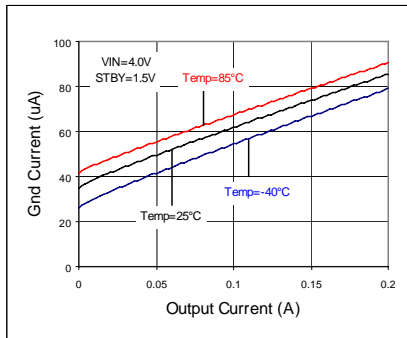

Fig 211. IOUT - IGND

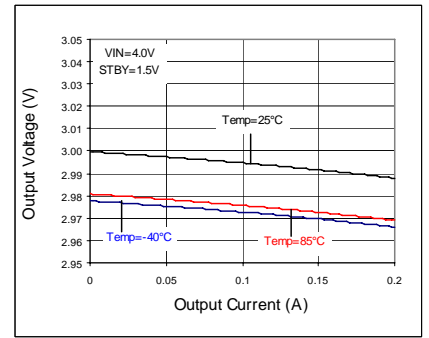

Fig 212. Load Regulation

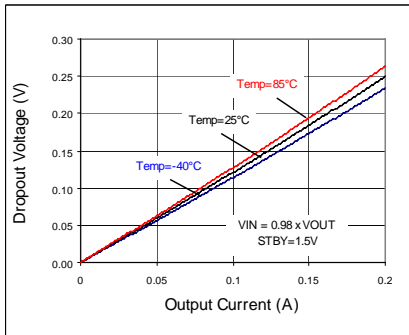

Fig 213. Dropout Voltage

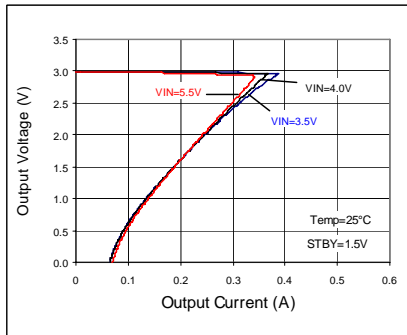

Fig 214. OCP Threshold

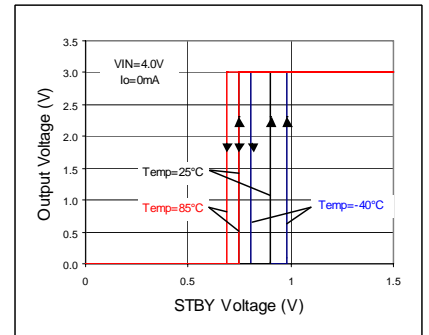

Fig 215. STBY Threshold

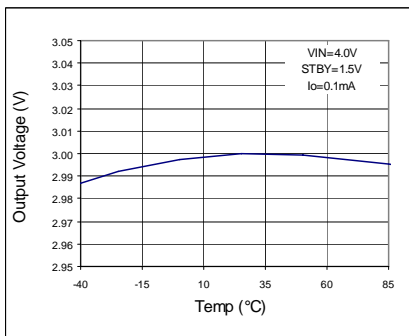

Fig 216. VOUT - Temp

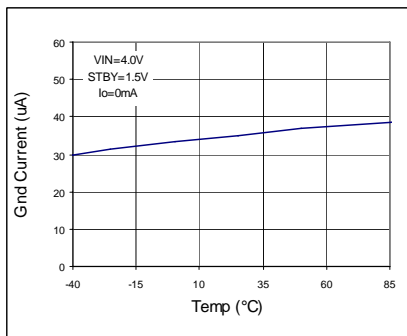

Fig 217. IGND - Temp

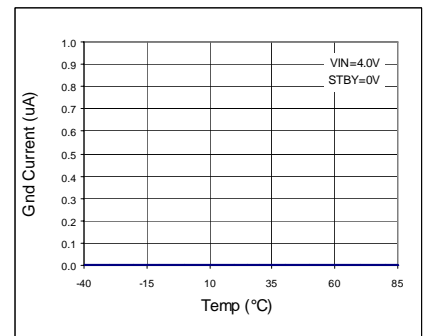

Fig 218. IGND - Temp (STBY)

● Reference data BU30TD2WNVX (Ta=25°C unless otherwise specified.)

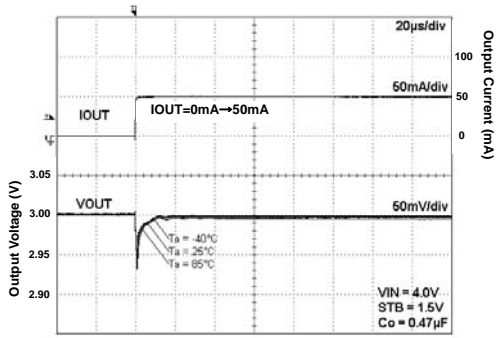

Fig 219. Load Response

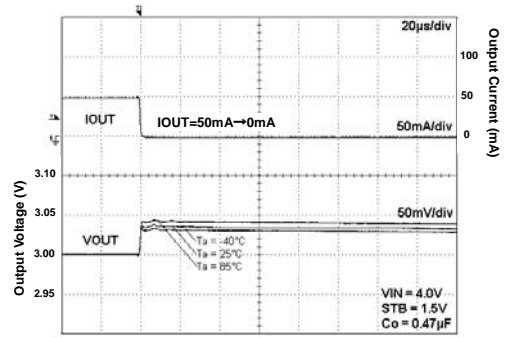

Fig 220. Load Response

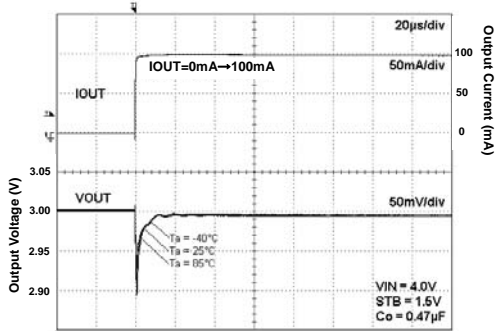

Fig 221. Load Response

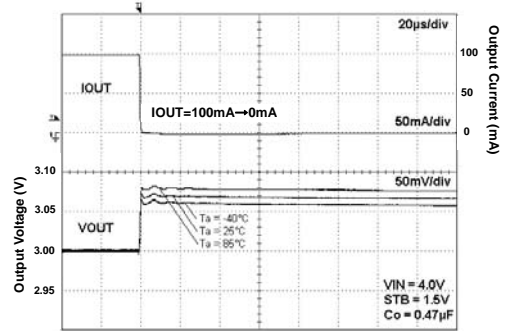

Fig 222. Load Response

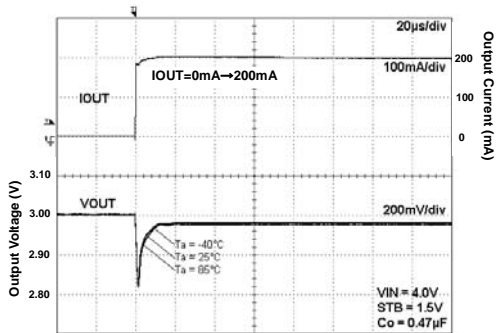

Fig 223. Load Response

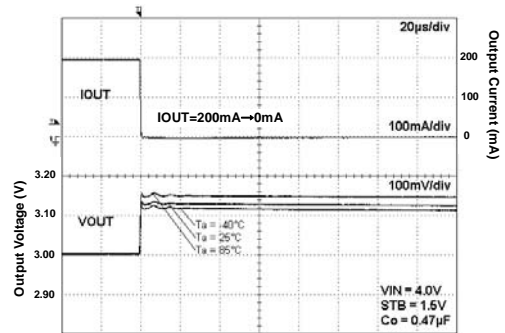

Fig 224. Load Response

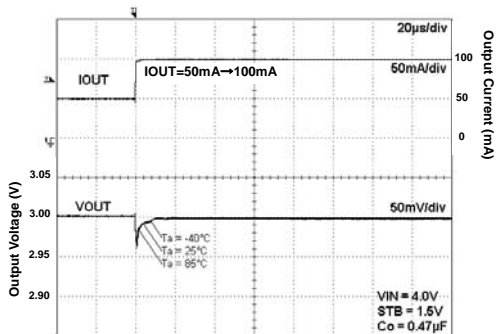

Fig 225. Load Response

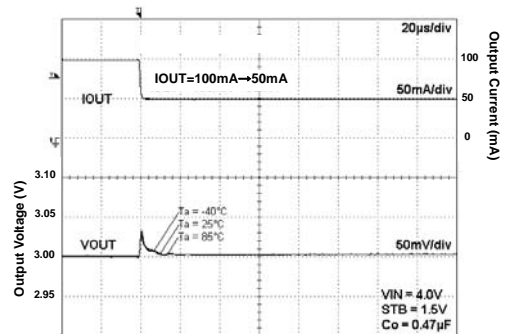

Fig 226. Load Response

●Reference data BU30TD2WNVX (Ta=25°C unless otherwise specified.)

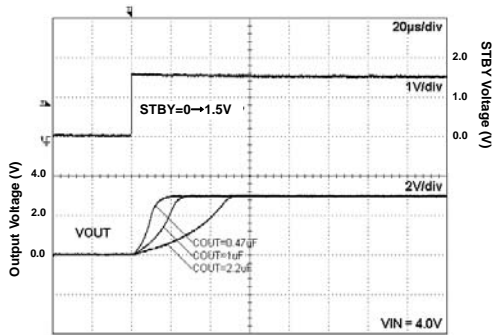

Fig 227. Start Up Time
Iout=0mA

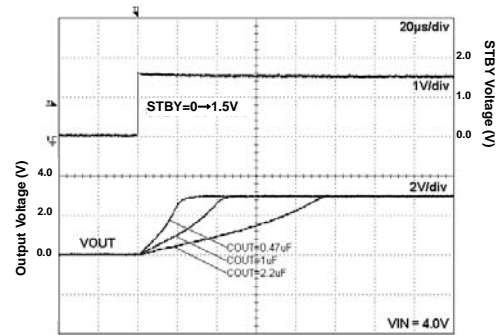

Fig 228. Start Up Time
Iout=200mA

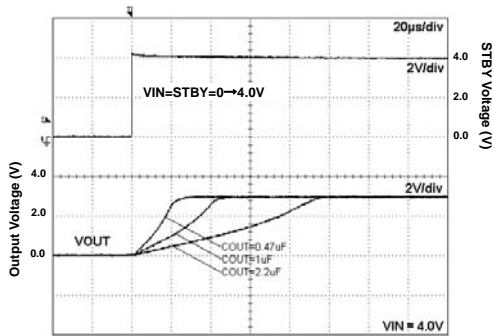

Fig 229. Start Up Time
(VIN=STBY) Iout=0mA

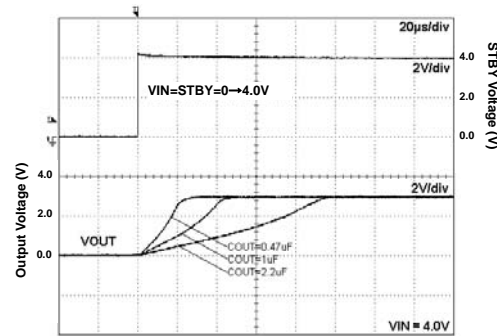

Fig 230. Start Up Time
(VIN=STBY) Iout=200mA

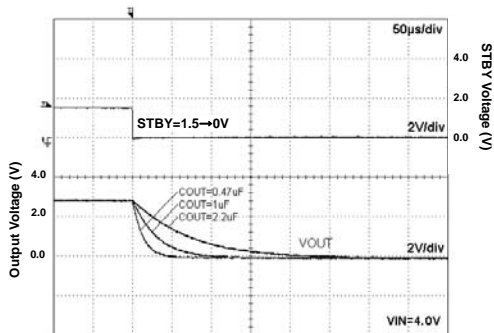

Fig 231. Discharge Time

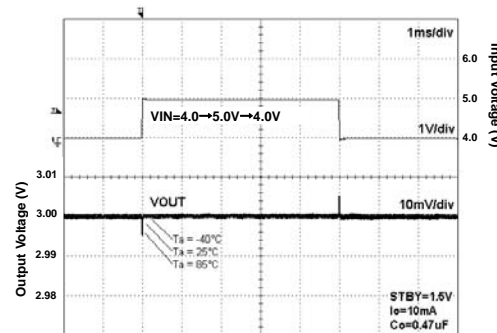

Fig 232. VIN Response

●Reference data BU31TD2WNVX (Ta=25°C unless otherwise specified.)

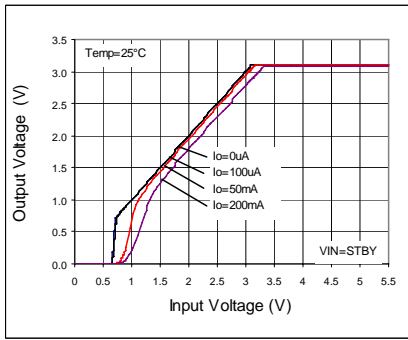

Fig 233. Output Voltage

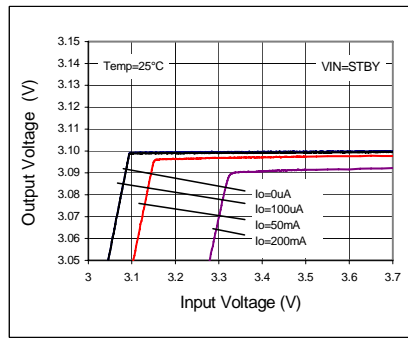

Fig 234. Line Regulation

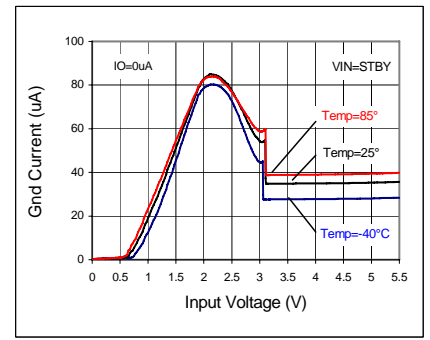

Fig 235. Circuit Current IGND

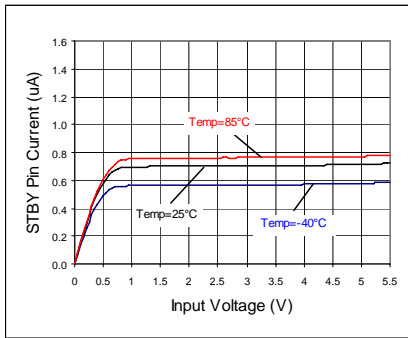

Fig 236. VSTBY - ISTBY

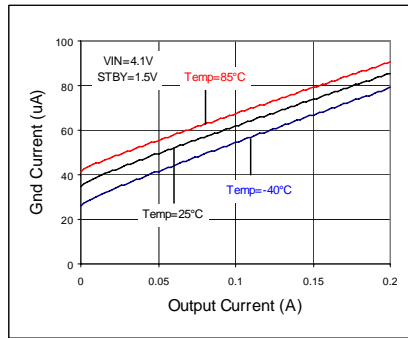

Fig 237. IOU - IGND

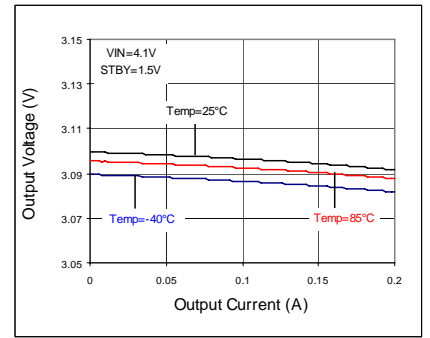

Fig 238. Load Regulation

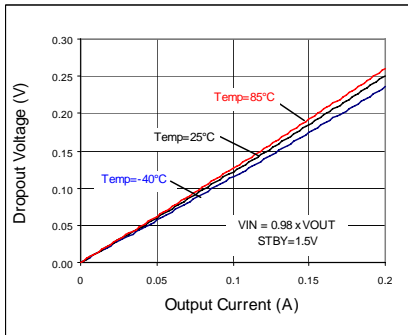

Fig 239. Dropout Voltage

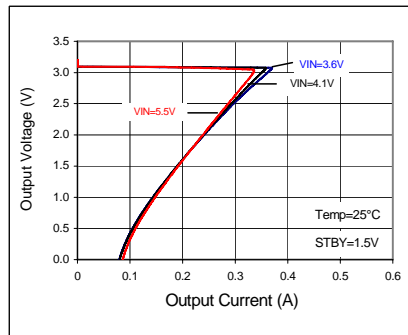

Fig 240. OCP Threshold

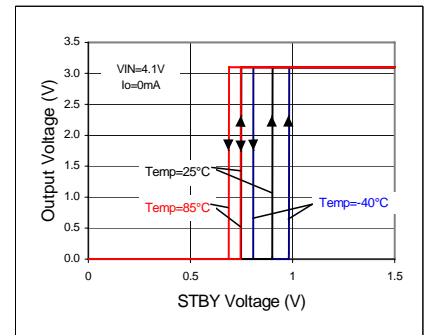

Fig 241. STBY Threshold

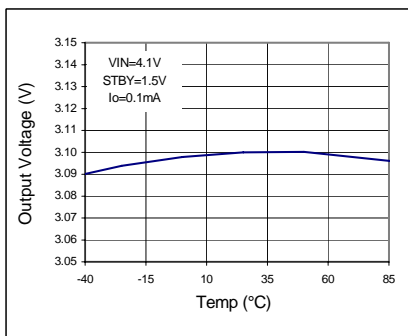

Fig 242. VOUT - Temp

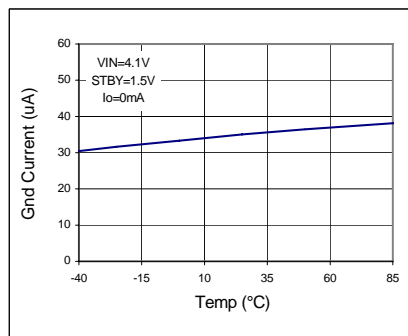

Fig 243. IGND - Temp

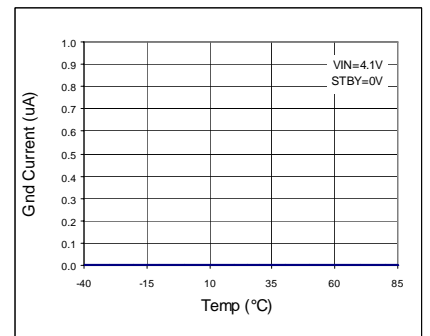

Fig 244. IGND - Temp (STBY)

● Reference data BU31TD2WNVX (Ta=25°C unless otherwise specified.)

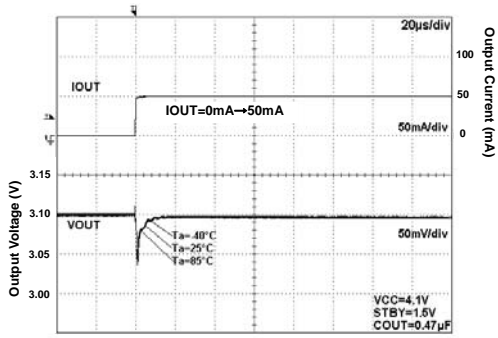

Fig 245. Load Response

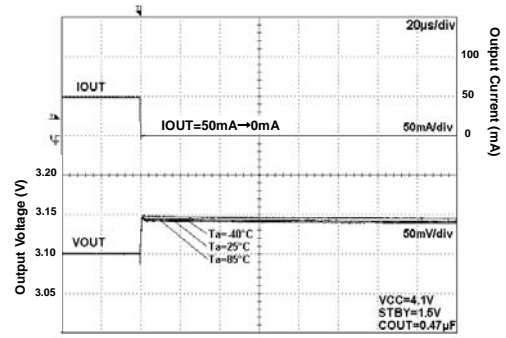

Fig 246. Load Response

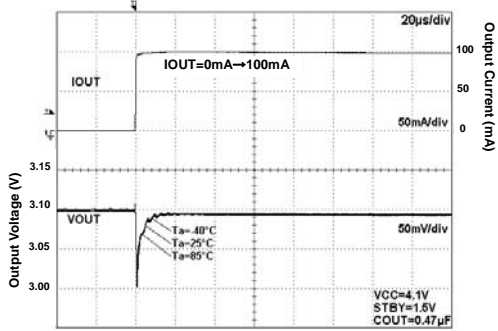

Fig 247. Load Response

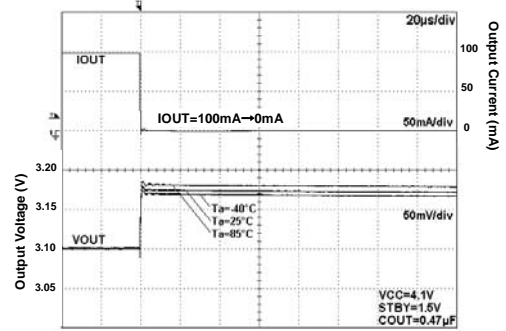

Fig 248. Load Response

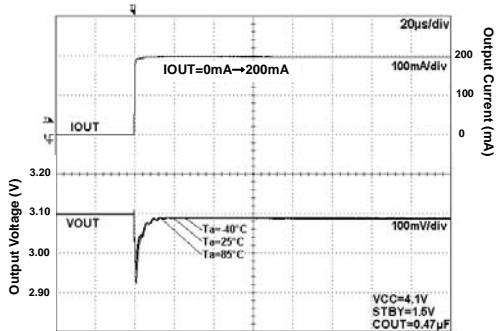

Fig 249. Load Response

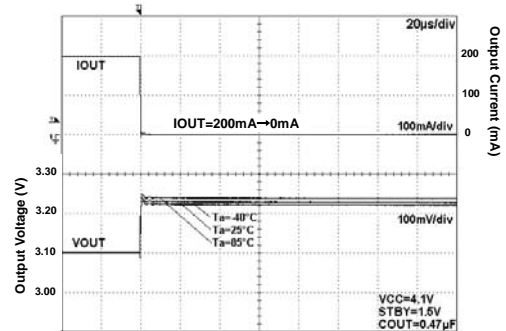

Fig 250. Load Response

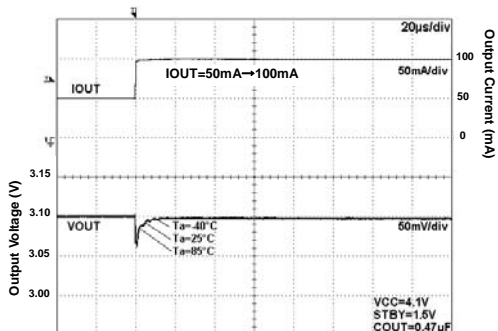

Fig 251. Load Response

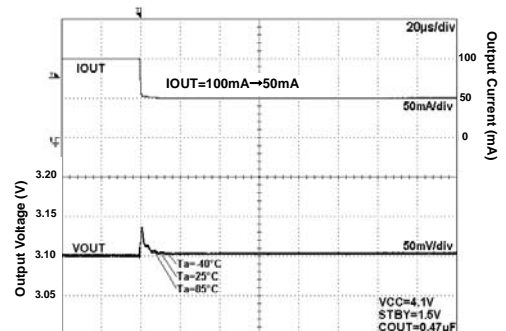

Fig 252. Load Response

●Reference data BU31TD2WNVX (Ta=25°C unless otherwise specified.)

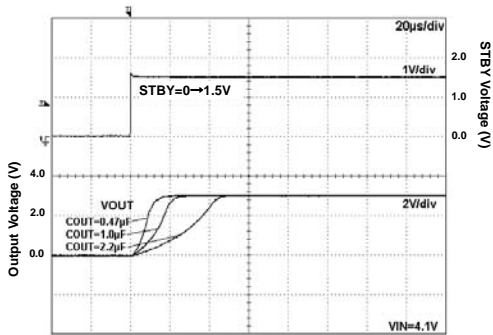

Fig 253. Start Up Time
Iout=0mA

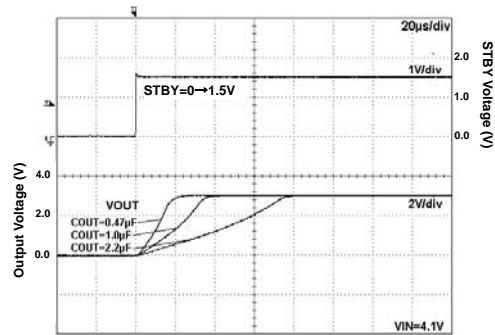

Fig 254. Start Up Time
Iout=200mA

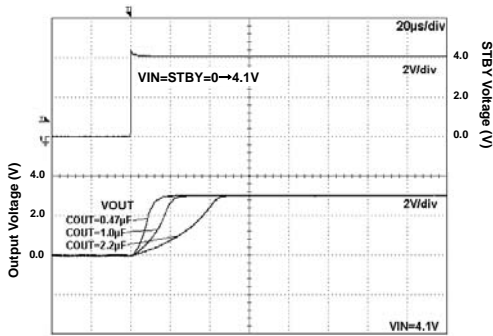

Fig 255. Start Up Time
(VIN=STBY) Iout=0mA

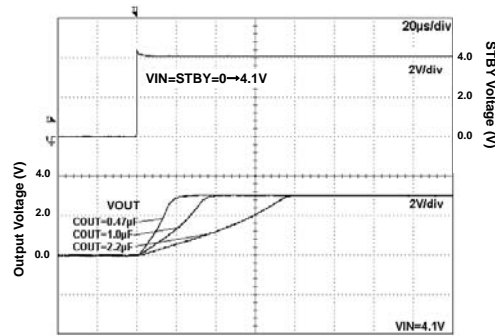

Fig 256. Start Up Time
(VIN=STBY) Iout=200mA

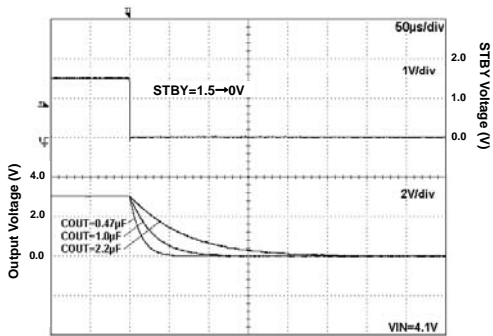

Fig 257. Discharge Time

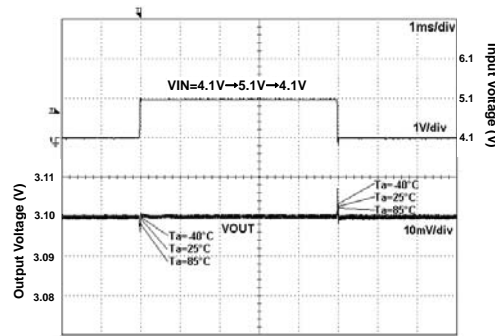

Fig 258. VIN Response

●Reference data BU33TD2WNVX (Ta=25°C unless otherwise specified.)

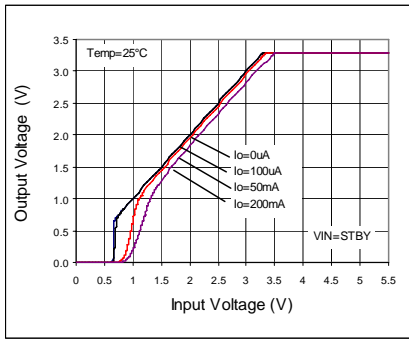

Fig 259. Output Voltage

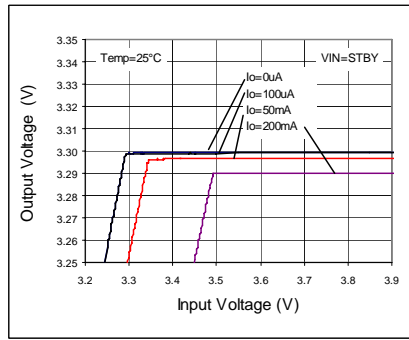

Fig 260. Line Regulation

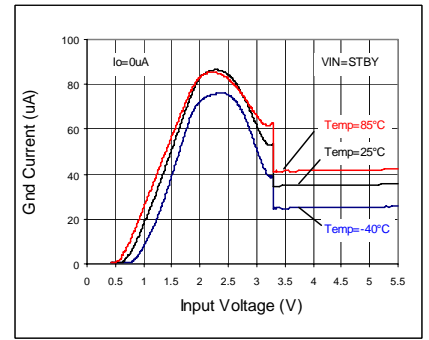

Fig 261. Circuit Current IGND

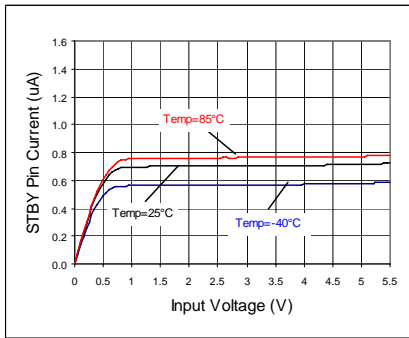

Fig 262. VSTBY - ISTBY

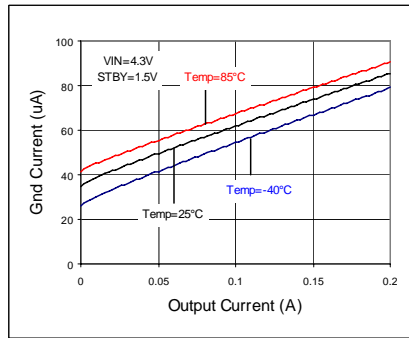

Fig 263. IOUT - IGND

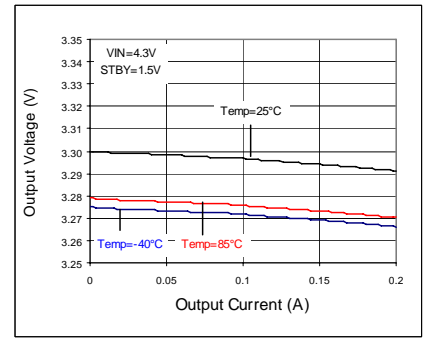

Fig 264. Load Regulation

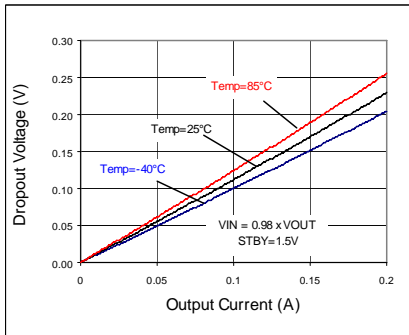

Fig 265. Dropout Voltage

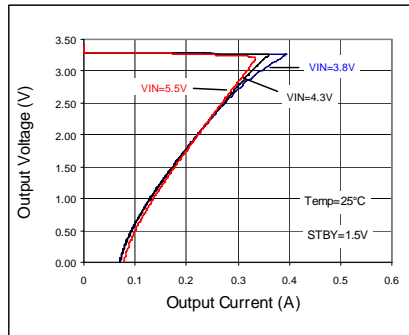

Fig 266. OCP Threshold

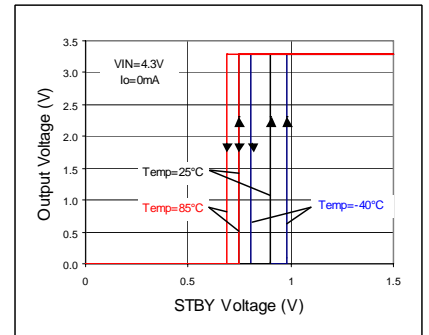

Fig 267. STBY Threshold

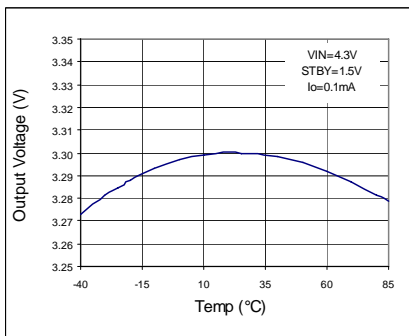

Fig 268. VOUT - Temp

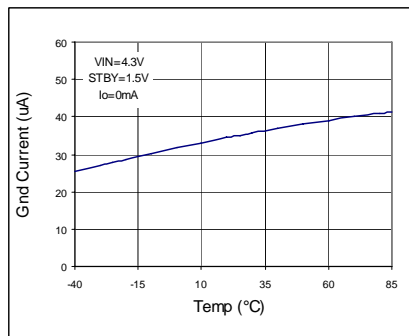

Fig 269. IGND - Temp

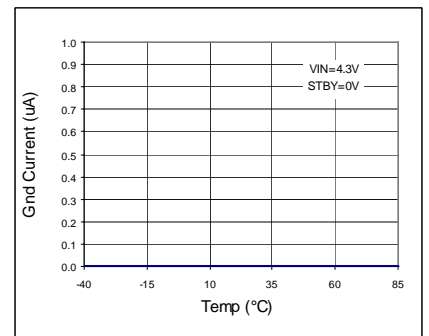

Fig 270. IGND - Temp (STBY)

● Reference data BU33TD2WNVX (Ta=25°C unless otherwise specified.)

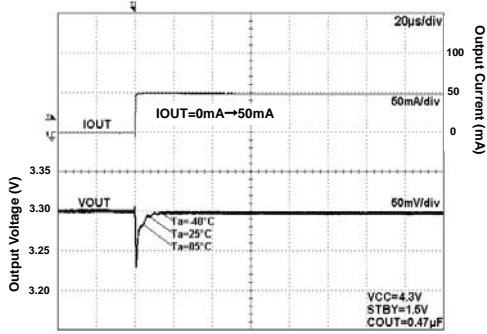

Fig 271. Load Response

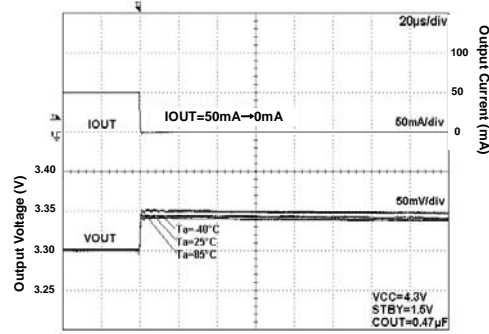

Fig 272. Load Response

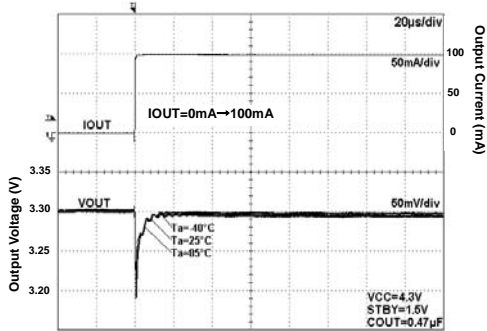

Fig 273. Load Response

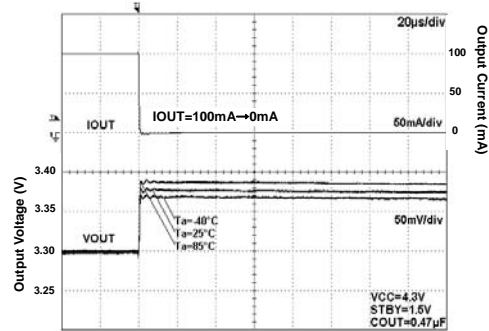

Fig 274. Load Response

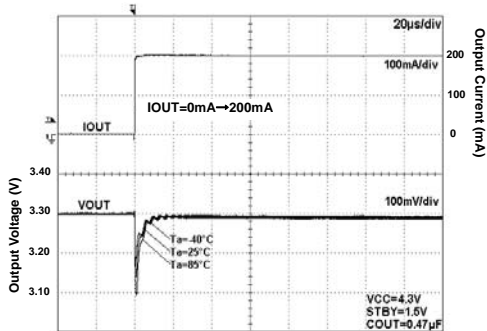

Fig 275. Load Response

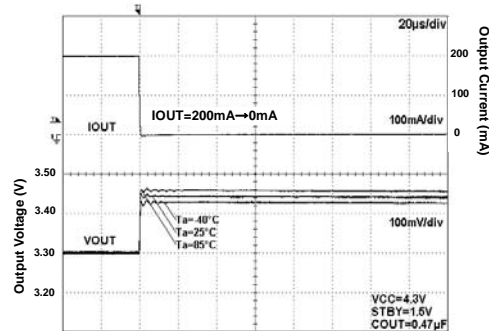

Fig 276. Load Response

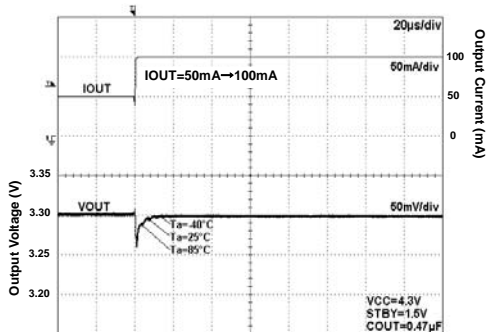

Fig 277. Load Response

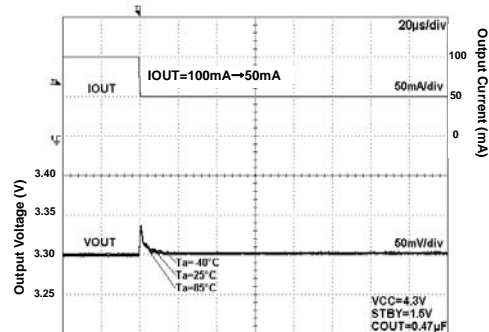

Fig 278. Load Response

●Reference data BU33TD2WNVX (Ta=25°C unless otherwise specified.)

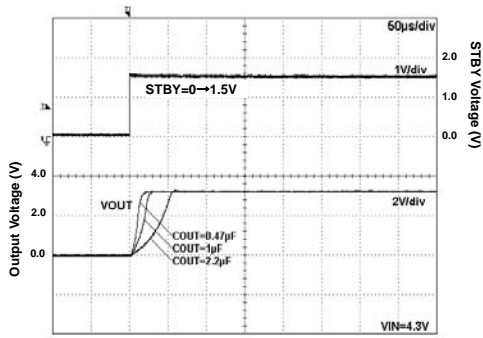

Fig 279. Start Up Time
Iout=0mA

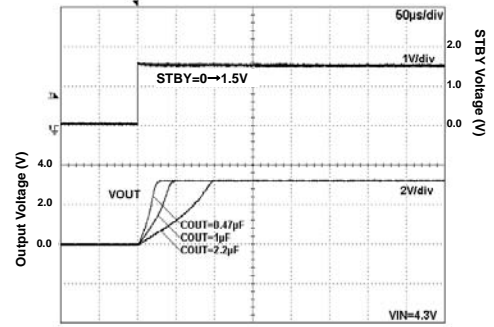

Fig 280. Start Up Time
Iout=200mA

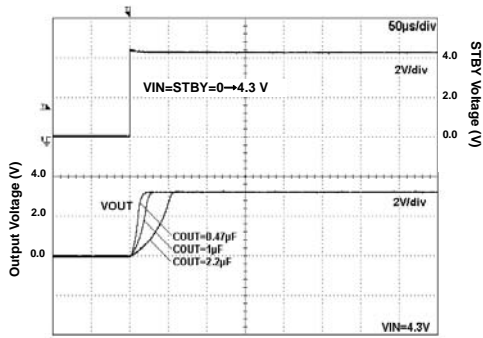

Fig 281. Start Up Time
(VIN=STBY) Iout=0mA
Iout=0mA

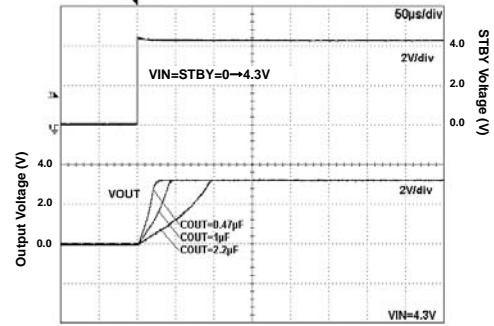

Fig 282. Start Up Time
(VIN=STBY) Iout=200mA

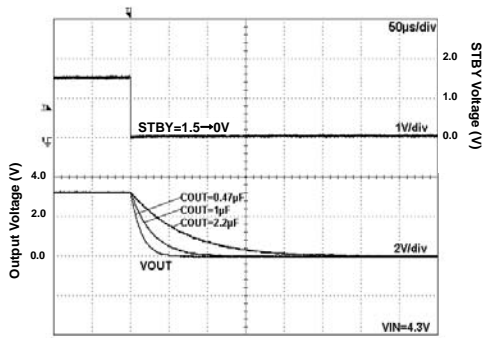

Fig 283. Discharge Time

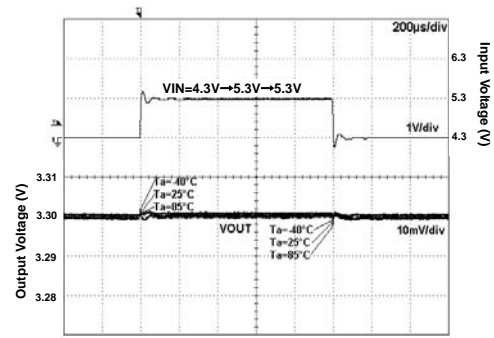

Fig 284. VIN Response

● About power dissipation (Pd)

As for power dissipation, an approximate estimate of the heat reduction characteristics and internal power consumption of IC are shown, so please use these for reference. Since power dissipation changes substantially depending on the implementation conditions (board size, board thickness, metal wiring rate, number of layers and through holes, etc.), it is recommended to measure Pd on a set board. Exceeding the power dissipation of IC may lead to deterioration of the original IC performance, such as causing operation of the thermal shutdown circuit or reduction in current capability. Therefore, be sure to prepare sufficient margin within power dissipation for usage.

Calculation of the maximum internal power consumption of IC (P_{MAX})

$$P_{MAX} = (V_{IN} - V_{OUT}) \times I_{OUT(MAX)}$$

(V_{IN}: Input voltage V_{OUT}: Output voltage I_{OUT(MAX)}: Maximum output current)

○ Measurement conditions

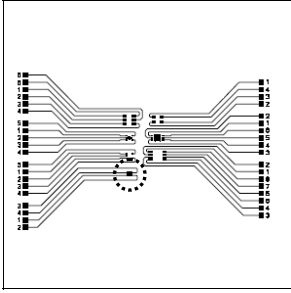
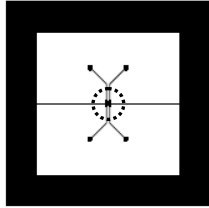
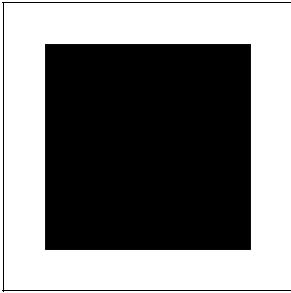
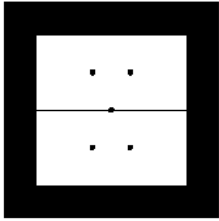
		Standard ROHM Board	Evaluation Board 1
Layout of Board for Measurement			
	IC Implementation Position		
Measurement State		With board implemented (Wind speed 0 m/s)	With board implemented (Wind speed 0 m/s)
Board Material		Glass epoxy resin (Double-side board)	Glass epoxy resin (Double-side board)
Board Size		70 mm x 70 mm x 1.6 mm	40 mm x 40 mm x 1.6 mm
Wiring Rate	Top layer	Metal (GND) wiring rate: Approx. 0%	Metal (GND) wiring rate: Approx. 50%
	Bottom layer	Metal (GND) wiring rate: Approx. 50%	Metal (GND) wiring rate: Approx. 50%
Through Hole		Diameter 0.5mm x 6 holes	Diameter 0.5mm x 25 holes
Power Dissipation		0.56W	0.39W
Thermal Resistance		θ _{ja} =178.6°C/W	θ _{ja} =256.4°C/W

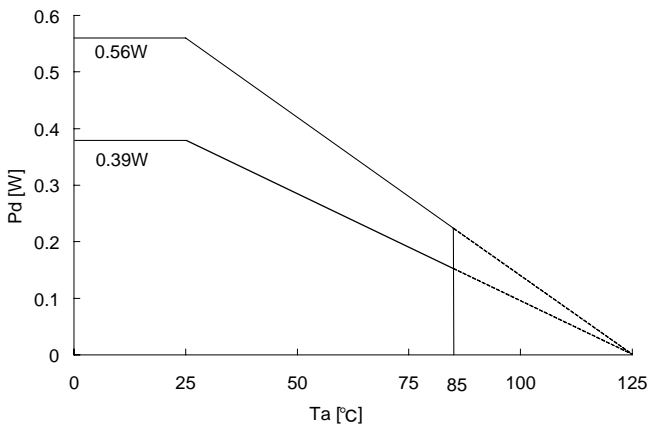

* Please design the margin so that P_{MAX} becomes is than Pd (P_{MAX}<Pd) within the usage temperature range

Fig. 285 SSON004X1010 Power dissipation heat reduction characteristics (Reference)

●Operation Notes

1.) **Absolute maximum ratings**

Use of the IC in excess of absolute maximum ratings (such as the input voltage or operating temperature range) may result in damage to the IC. Assumptions should not be made regarding the state of the IC (e.g., short mode or open mode) when such damage is suffered. If operational values are expected to exceed the maximum ratings for the device, consider adding protective circuitry (such as fuses) to eliminate the risk of damaging the IC.

2.) **GND potential**

The potential of the GND pin must be the minimum potential in the system in all operating conditions. Never connect a potential lower than GND to any pin, even if only transiently.

3.) **Thermal design**

Use a thermal design that allows for a sufficient margin for that package power dissipation rating (Pd) under actual operating conditions.

4.) **Inter-pin shorts and mounting errors**

Use caution when orienting and positioning the IC for mounting on printed circuit boards. Improper mounting or shorts between pins may result in damage to the IC.

5.) **Operation in strong electromagnetic fields**

Strong electromagnetic fields may cause the IC to malfunction. Caution should be exercised in applications where strong electromagnetic fields may be present.

6.) **Common impedance**

Wiring traces should be as short and wide as possible to minimize common impedance. Bypass capacitors should be used to keep ripple to a minimum.

7.) **Voltage of STBY pin**

To enable standby mode for all channels, set the STBY pin to 0.3 V or less, and for normal operation, to 1.2 V or more. Setting STBY to a voltage between 0.3 and 1.2 V may cause malfunction and should be avoided. Keep transition time between high and low (or vice versa) to a minimum.

Additionally, if STBY is shorted to VIN, the IC will switch to standby mode and disable the output discharge circuit, causing a temporary voltage to remain on the output pin. If the IC is switched on again while this voltage is present, overshoot may occur on the output. Therefore, in applications where these pins are shorted, the output should always be completely discharged before turning the IC on.

8.) **Over-current protection circuit (OCP)**

This IC features an integrated over-current and short-protection circuitry on the output to prevent destruction of the IC when the output is shorted. The OCP circuitry is designed only to protect the IC from irregular conditions (such as motor output shorts) and is not designed to be used as an active security device for the application. Therefore, applications should not be designed under the assumption that this circuitry will engage.

9.) **Thermal shutdown circuit (TSD)**

This IC also features a thermal shutdown circuit that is designed to turn the output off when the junction temperature of the IC exceeds about 150°C. This feature is intended to protect the IC only in the event of thermal overload and is not designed to guarantee operation or act as an active security device for the application. Therefore, applications should not be designed under the assumption that this circuitry will engage.

10.) **Input/output capacitor**

Capacitors must be connected between the input/output pins and GND for stable operation, and should be physically mounted as close to the IC pins as possible. The input capacitor helps to counteract increases in power supply impedance, and increases stability in applications with long or winding power supply traces. The output capacitance value is directly related to the overall stability and transient response of the regulator, and should be set to the largest μ Unstable region μ r the application to increase these characteristics. During design, keep in mind that in general, ceramic capacitors have a wide range of tolerances, temperature coefficients and DC bias characteristics, and that their capacitance values tend to decrease over time. Confirm these details before choosing appropriate capacitors for your application. (Please refer the technical note, regarding ceramic capacitor of recommendation)

11.) **About the equivalent series resistance (ESR) of a ceramic capacitor**

Capacitors generally have ESR (equivalent series resistance) and it operates stably in the ESR-IOUT area shown on the right. Since ceramic capacitors, tantalum capacitors, electrolytic capacitors, etc. generally have different ESR, please check the ESR of the capacitor to be used and use it within the stability area range shown in the right graph for evaluation of the actual application.

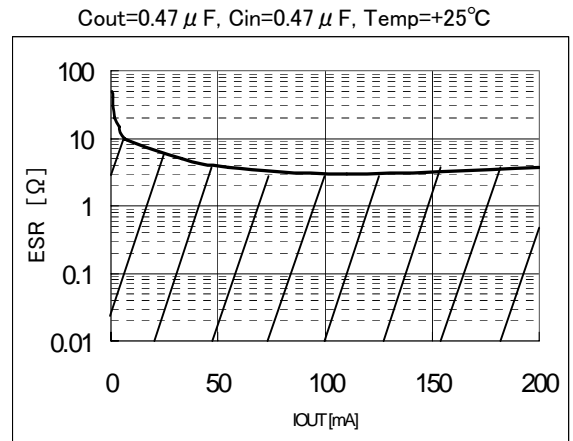

Fig. 286 Stable region (example)

● Revision History

Date	Revision	Changes
7.Feb.2013	001	New Release.
15.Mar.2013	002	Adding Reference data. Adding a Revision History.
24.Apr.2013	003	Adding 1.3V product.
31.Jul.2013	004	Adding dropout voltage. Delete ELECTRICAL CHARACTERISTICS of each Output Voltage. VSBYH is changed.
21.Aug.2013	005	Adding dropout voltage.
28.Aug.2013	006	Ordering Information is changed.
24.Oct.2013	007	Adding Pin Descriptions. Adding BOTTOM VIEW.
14.Jan.2014	008	Adding 1.1V product

Notice

Precaution on using ROHM Products

- Our Products are designed and manufactured for application in ordinary electronic equipments (such as AV equipment, OA equipment, telecommunication equipment, home electronic appliances, amusement equipment, etc.). If you intend to use our Products in devices requiring extremely high reliability (such as medical equipment ^(Note 1), transport equipment, traffic equipment, aircraft/spacecraft, nuclear power controllers, fuel controllers, car equipment including car accessories, safety devices, etc.) and whose malfunction or failure may cause loss of human life, bodily injury or serious damage to property ("Specific Applications"), please consult with the ROHM sales representative in advance. Unless otherwise agreed in writing by ROHM in advance, ROHM shall not be in any way responsible or liable for any damages, expenses or losses incurred by you or third parties arising from the use of any ROHM's Products for Specific Applications.

(Note1) Medical Equipment Classification of the Specific Applications

JAPAN	USA	EU	CHINA
CLASS III	CLASS III	CLASS II b	CLASS III
CLASS IV		CLASS III	

- ROHM designs and manufactures its Products subject to strict quality control system. However, semiconductor products can fail or malfunction at a certain rate. Please be sure to implement, at your own responsibilities, adequate safety measures including but not limited to fail-safe design against the physical injury, damage to any property, which a failure or malfunction of our Products may cause. The following are examples of safety measures:
 - Installation of protection circuits or other protective devices to improve system safety
 - Installation of redundant circuits to reduce the impact of single or multiple circuit failure
- Our Products are designed and manufactured for use under standard conditions and not under any special or extraordinary environments or conditions, as exemplified below. Accordingly, ROHM shall not be in any way responsible or liable for any damages, expenses or losses arising from the use of any ROHM's Products under any special or extraordinary environments or conditions. If you intend to use our Products under any special or extraordinary environments or conditions (as exemplified below), your independent verification and confirmation of product performance, reliability, etc. prior to use, must be necessary:
 - Use of our Products in any types of liquid, including water, oils, chemicals, and organic solvents
 - Use of our Products outdoors or in places where the Products are exposed to direct sunlight or dust
 - Use of our Products in places where the Products are exposed to sea wind or corrosive gases, including Cl₂, H₂S, NH₃, SO₂, and NO₂
 - Use of our Products in places where the Products are exposed to static electricity or electromagnetic waves
 - Use of our Products in proximity to heat-producing components, plastic cords, or other flammable items
 - Sealing or coating our Products with resin or other coating materials
 - Use of our Products without cleaning residue of flux (even if you use no-clean type fluxes, cleaning residue of flux is recommended); or Washing our Products by using water or water-soluble cleaning agents for cleaning residue after soldering
 - Use of the Products in places subject to dew condensation
- The Products are not subject to radiation-proof design.
- Please verify and confirm characteristics of the final or mounted products in using the Products.
- In particular, if a transient load (a large amount of load applied in a short period of time, such as pulse. is applied, confirmation of performance characteristics after on-board mounting is strongly recommended. Avoid applying power exceeding normal rated power; exceeding the power rating under steady-state loading condition may negatively affect product performance and reliability.
- De-rate Power Dissipation (Pd) depending on Ambient temperature (Ta). When used in sealed area, confirm the actual ambient temperature.
- Confirm that operation temperature is within the specified range described in the product specification.
- ROHM shall not be in any way responsible or liable for failure induced under deviant condition from what is defined in this document.

Precaution for Mounting / Circuit board design

- When a highly active halogenous (chlorine, bromine, etc.) flux is used, the residue of flux may negatively affect product performance and reliability.
- In principle, the reflow soldering method must be used; if flow soldering method is preferred, please consult with the ROHM representative in advance.

For details, please refer to ROHM Mounting specification

Precautions Regarding Application Examples and External Circuits

1. If change is made to the constant of an external circuit, please allow a sufficient margin considering variations of the characteristics of the Products and external components, including transient characteristics, as well as static characteristics.
2. You agree that application notes, reference designs, and associated data and information contained in this document are presented only as guidance for Products use. Therefore, in case you use such information, you are solely responsible for it and you must exercise your own independent verification and judgment in the use of such information contained in this document. ROHM shall not be in any way responsible or liable for any damages, expenses or losses incurred by you or third parties arising from the use of such information.

Precaution for Electrostatic

This Product is electrostatic sensitive product, which may be damaged due to electrostatic discharge. Please take proper caution in your manufacturing process and storage so that voltage exceeding the Products maximum rating will not be applied to Products. Please take special care under dry condition (e.g. Grounding of human body / equipment / solder iron, isolation from charged objects, setting of Ionizer, friction prevention and temperature / humidity control).

Precaution for Storage / Transportation

1. Product performance and soldered connections may deteriorate if the Products are stored in the places where:
 - [a] the Products are exposed to sea winds or corrosive gases, including Cl₂, H₂S, NH₃, SO₂, and NO₂
 - [b] the temperature or humidity exceeds those recommended by ROHM
 - [c] the Products are exposed to direct sunshine or condensation
 - [d] the Products are exposed to high Electrostatic
2. Even under ROHM recommended storage condition, solderability of products out of recommended storage time period may be degraded. It is strongly recommended to confirm solderability before using Products of which storage time is exceeding the recommended storage time period.
3. Store / transport cartons in the correct direction, which is indicated on a carton with a symbol. Otherwise bent leads may occur due to excessive stress applied when dropping of a carton.
4. Use Products within the specified time after opening a humidity barrier bag. Baking is required before using Products of which storage time is exceeding the recommended storage time period.

Precaution for Product Label

QR code printed on ROHM Products label is for ROHM's internal use only.

Precaution for Disposition

When disposing Products please dispose them properly using an authorized industry waste company.

Precaution for Foreign Exchange and Foreign Trade act

Since our Products might fall under controlled goods prescribed by the applicable foreign exchange and foreign trade act, please consult with ROHM representative in case of export.

Precaution Regarding Intellectual Property Rights

1. All information and data including but not limited to application example contained in this document is for reference only. ROHM does not warrant that foregoing information or data will not infringe any intellectual property rights or any other rights of any third party regarding such information or data. ROHM shall not be in any way responsible or liable for infringement of any intellectual property rights or other damages arising from use of such information or data.:
2. No license, expressly or implied, is granted hereby under any intellectual property rights or other rights of ROHM or any third parties with respect to the information contained in this document.

Other Precaution

1. This document may not be reprinted or reproduced, in whole or in part, without prior written consent of ROHM.
2. The Products may not be disassembled, converted, modified, reproduced or otherwise changed without prior written consent of ROHM.
3. In no event shall you use in any way whatsoever the Products and the related technical information contained in the Products or this document for any military purposes, including but not limited to, the development of mass-destruction weapons.
4. The proper names of companies or products described in this document are trademarks or registered trademarks of ROHM, its affiliated companies or third parties.

General Precaution

1. Before you use our Products, you are requested to carefully read this document and fully understand its contents. ROHM shall not be in any way responsible or liable for failure, malfunction or accident arising from the use of any ROHM's Products against warning, caution or note contained in this document.
2. All information contained in this document is current as of the issuing date and subject to change without any prior notice. Before purchasing or using ROHM's Products, please confirm the latest information with a ROHM sales representative.
3. The information contained in this document is provided on an "as is" basis and ROHM does not warrant that all information contained in this document is accurate and/or error-free. ROHM shall not be in any way responsible or liable for any damages, expenses or losses incurred by you or third parties resulting from inaccuracy or errors of or concerning such information.

Компания «Океан Электроники» предлагает заключение долгосрочных отношений при поставках импортных электронных компонентов на взаимовыгодных условиях!

Наши преимущества:

- Поставка оригинальных импортных электронных компонентов напрямую с производств Америки, Европы и Азии, а так же с крупнейших складов мира;
- Широкая линейка поставок активных и пассивных импортных электронных компонентов (более 30 млн. наименований);
- Поставка сложных, дефицитных, либо снятых с производства позиций;
- Оперативные сроки поставки под заказ (от 5 рабочих дней);
- Экспресс доставка в любую точку России;
- Помощь Конструкторского Отдела и консультации квалифицированных инженеров;
- Техническая поддержка проекта, помощь в подборе аналогов, поставка прототипов;
- Поставка электронных компонентов под контролем ВП;
- Система менеджмента качества сертифицирована по Международному стандарту ISO 9001;
- При необходимости вся продукция военного и аэрокосмического назначения проходит испытания и сертификацию в лаборатории (по согласованию с заказчиком);
- Поставка специализированных компонентов военного и аэрокосмического уровня качества (Xilinx, Altera, Analog Devices, Intersil, Interpoint, Microsemi, Actel, Aeroflex, Peregrine, VPT, Syfer, Eurofarad, Texas Instruments, MS Kennedy, Miteq, Cobham, E2V, MA-COM, Hittite, Mini-Circuits, General Dynamics и др.);

Компания «Океан Электроники» является официальным дистрибьютором и эксклюзивным представителем в России одного из крупнейших производителей разъемов военного и аэрокосмического назначения «**JONHON**», а так же официальным дистрибьютором и эксклюзивным представителем в России производителя высокотехнологичных и надежных решений для передачи СВЧ сигналов «**FORSTAR**».



JONHON

«**JONHON**» (основан в 1970 г.)

Разъемы специального, военного и аэрокосмического назначения:

(Применяются в военной, авиационной, аэрокосмической, морской, железнодорожной, горно- и нефтедобывающей отраслях промышленности)

«**FORSTAR**» (основан в 1998 г.)

ВЧ соединители, коаксиальные кабели, кабельные сборки и микроволновые компоненты:

(Применяются в телекоммуникациях гражданского и специального назначения, в средствах связи, РЛС, а так же военной, авиационной и аэрокосмической отраслях промышленности).



Телефон: 8 (812) 309-75-97 (многоканальный)

Факс: 8 (812) 320-03-32

Электронная почта: ocean@oceanchips.ru

Web: <http://oceanchips.ru/>

Адрес: 198099, г. Санкт-Петербург, ул. Калинина, д. 2, корп. 4, лит. А