

## SPDT SWITCH GaAs MMIC

### ■ GENERAL DESCRIPTION

The NJG1801K75 is a SPDT switch IC suited for switching transmit/receive signals at 802.11 a/b/g/n/ac applications.

The NJG1801K75 features low insertion loss, high isolation, and high handling power.

This switch exhibits wide frequency coverage up to 6.0GHz. And the ultra small and ultra thin package of DFN6-75 is adopted.

### ■ PACKAGE OUTLINE

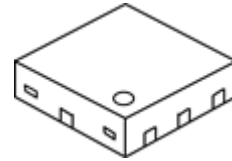

NJG1801K75

### ■ APPLICATION

802.11 a/b/g/n/ac networks applications

Transmit / receive switching, path switching applications

### ■ FEATURES

- Control voltage  $V_{CTL(H)}=3.0V$  typ.  
 $V_{CTL(L)}=0V$  typ.
- Low insertion loss 0.35dB typ. @f=2.4 to 2.5GHz  
0.45dB typ. @f=4.9 to 5.9GHz
- High isolation 28dB typ. @f=2.4 to 2.5GHz  
30dB typ. @f=4.9 to 5.9GHz
- P-1dB  $P_{-1dB}=31$  dBm typ. @f=2.5GHz  
 $P_{-1dB}=31$  dBm typ. @f=5.9GHz
- Ultra small & ultra thin package DFN6-75 (Package Size: 1.0x1.0x0.375mm typ.)
- RoHS compliant and Halogen Free, MSL1

### ■ PIN CONFIGURATION

(Top view)

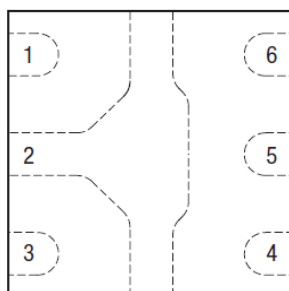

Pin connection

1. P1
2. GND
3. P2
4. VCTL2
5. PC
6. VCTL1

### ■ TRUTH TABLE

“H”= $V_{CTL(H)}$ , “L”= $V_{CTL(L)}$

ON PATH	VCTL1	VCTL2
PC-P1	L	H
PC-P2	H	L

NOTE: Please note that any data or drawing in this catalog is subject to change.

## ■ ABSOLUTE MAXIMUM RATINGS

$T_a=+25^{\circ}\text{C}$ ,  $Z_S=Z_I=50\ \Omega$

PARAMETER	SYMBOL	CONDITIONS	RATINGS	UNITS
RF Input Power	$P_{IN}$	$V_{CTL(L)}=0\text{V}$ , $V_{CTL(H)}=3.0\text{V}$ , ON State Port	+31	dBm
Control Voltage	$V_{CTL}$		6.0	V
Power Dissipation	$P_D$	4-layer FR4 PCB without through-hole (76.2x114.3mm), $T_i=150^{\circ}\text{C}$	430	mW
Operating Temperature	$T_{opr}$		-40 to +105	$^{\circ}\text{C}$
Storage Temperature	$T_{stg}$		-55 to +150	$^{\circ}\text{C}$

## ■ ELECTRICAL CHARACTERISTICS1 (DC CHARACTERISTICS)

(General conditions:  $V_{CTL(H)}=3.0\text{V}$ ,  $V_{CTL(L)}=0\text{V}$ ,  $T_a=+25^{\circ}\text{C}$ , with application circuit)

PARAMETERS	SYMBOL	CONDITIONS	MIN	TYP	MAX	UNITS
Control Voltage (HIGH)	$V_{CTL(H)}$		1.8	3.0	5.0	V
Control Voltage (LOW)	$V_{CTL(L)}$		-0.2	-	0.2	V
Control Current	$I_{CTL}$		-	5	10	$\mu\text{A}$

## ■ ELECTRICAL CHARACTERISTICS2 (RF CHARACTERISTICS)

(General conditions:  $V_{CTL(H)}=3.0V$ ,  $V_{CTL(L)}=0V$ ,  $T_a=+25^{\circ}C$ ,  $Z_S=Z_L=50\ \Omega$ , with application circuit)

PARAMETERS	SYMBOL	CONDITIONS	MIN	TYP	MAX	UNITS
Insertion loss1	LOSS1	f=2.4 to 2.5GHz	-	0.35	0.55	dB
Insertion loss2	LOSS2	f=4.9 to 5.9GHz	-	0.45	0.70	dB
Isolation1	ISL1	f=2.4 to 2.5GHz	25	28	-	dB
Isolation2	ISL2	f=4.9 to 5.9GHz	25	30	-	dB
Return loss1	RL1	f=2.4 to 2.5GHz	18	28	-	dB
Return loss2	RL2	f=4.9 to 5.9GHz	15	20	-	dB
Input power at 1dB compression point1	$P_{-1dB1}$	f=2.4 to 2.5GHz	29	31	-	dBm
Input power at 1dB compression point2	$P_{-1dB2}$	f=4.9 to 5.9GHz	28	31	-	dBm
Switching time	$T_{SW}$	50% VCTL to 10%/90% RF	-	100	300	ns

## ■ TERMINAL INFORMATION

No.	SYMBOL	DESCRIPTION
1	P1	RF terminal. An external DC blocking capacitor is required.
2	GND	Ground terminal. Please connect this terminal with ground plane as close as possible for excellent RF performance.
3	P2	RF terminal. An external DC blocking capacitor is required.
4	VCTL2	Control voltage input terminal.
5	PC	Common RF terminal. An external DC blocking capacitor is required.
6	VCTL1	Control voltage input terminal.

## ■ ELECTRICAL CHARACTERISTICS

### Loss, ISL vs Frequency

(PC-P1 ON,  $V_{CTL(H)}=3.0V$ ,  $V_{CTL(L)}=0V$ )

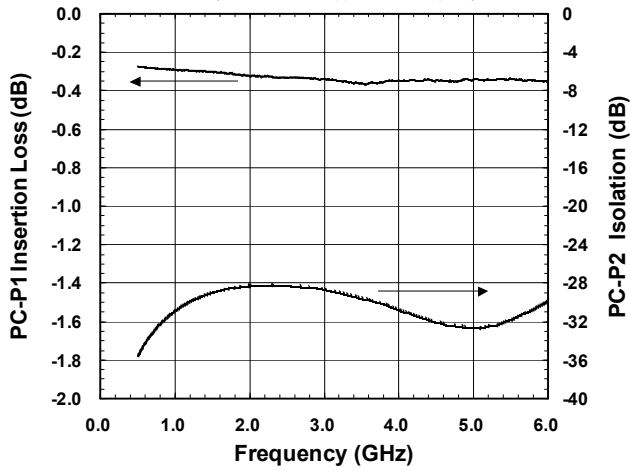

### Loss, ISL vs Frequency

(PC-P2 ON,  $V_{CTL(H)}=3.0V$ ,  $V_{CTL(L)}=0V$ )

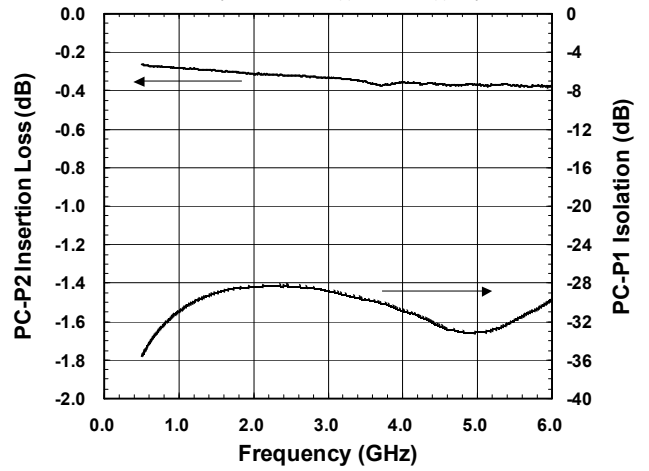

### Return Loss vs Frequency

(PC-P1 ON,  $V_{CTL(H)}=3.0V$ ,  $V_{CTL(L)}=0V$ )

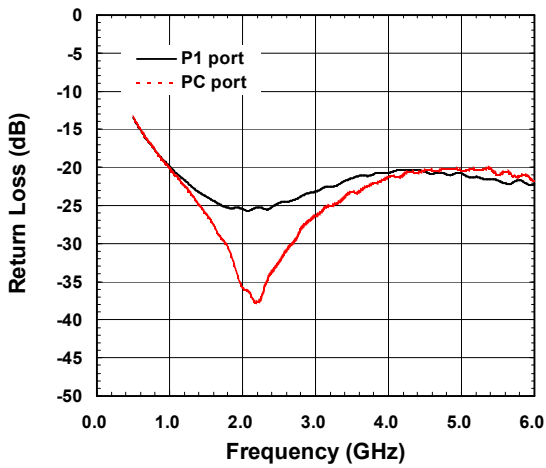

### Return Loss vs Frequency

(PC-P2 ON,  $V_{CTL(H)}=3.0V$ ,  $V_{CTL(L)}=0V$ )

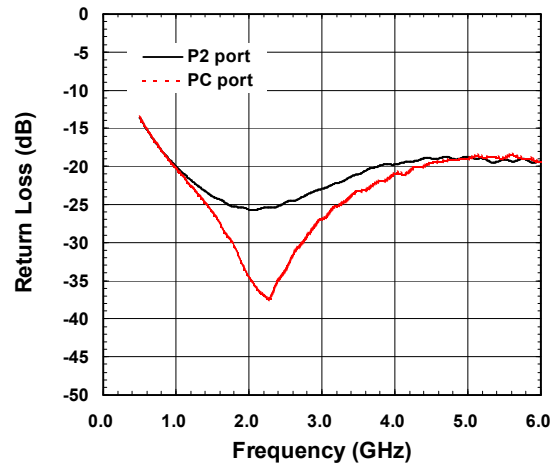

### Switching Time

(PC-P1 Path,  $V_{CTL(H)}=3.0V$ ,  $V_{CTL(L)}=0V$ )

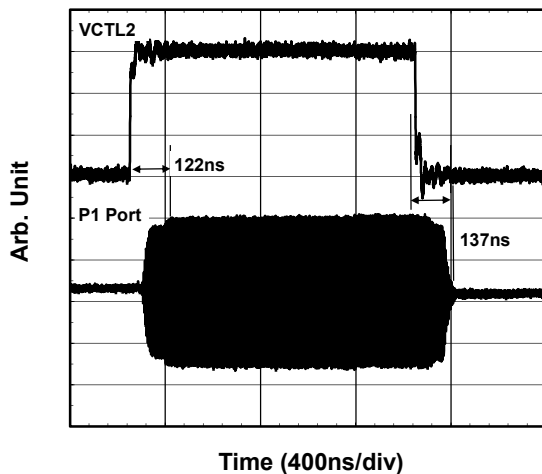

## ■ ELECTRICAL CHARACTERISTICS

### Output Power, $I_{CTL}$ vs Input Power

(PC-P1 ON,  $V_{CTL(L)}=0V$ ,  $f=2.5GHz$ )

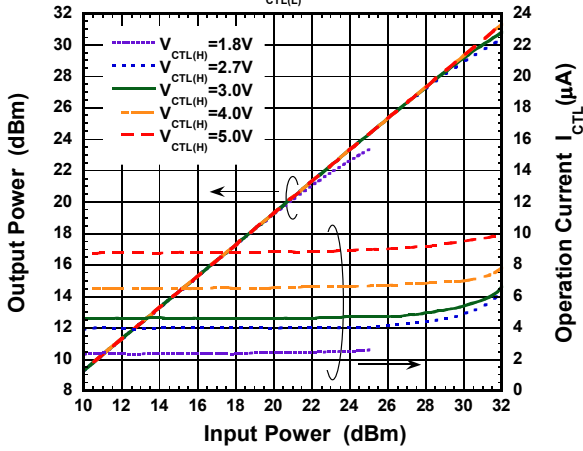

### Loss, ISL vs Input Power

(PC-P1 ON,  $V_{CTL(L)}=0V$ ,  $f=2.5GHz$ )

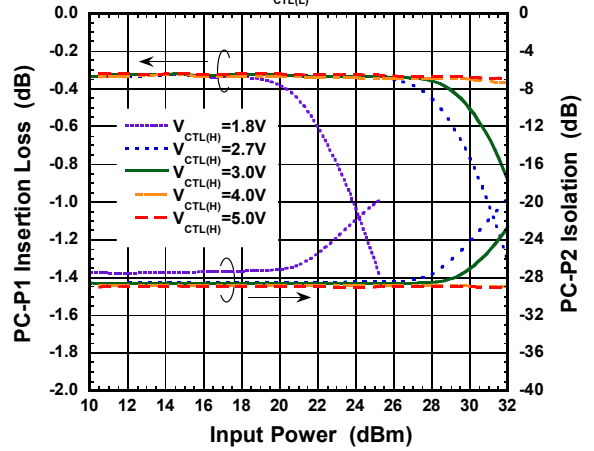

### Output Power, $I_{CTL}$ vs Input Power

(PC-P1 ON,  $V_{CTL(L)}=0V$ ,  $f=5.9GHz$ )

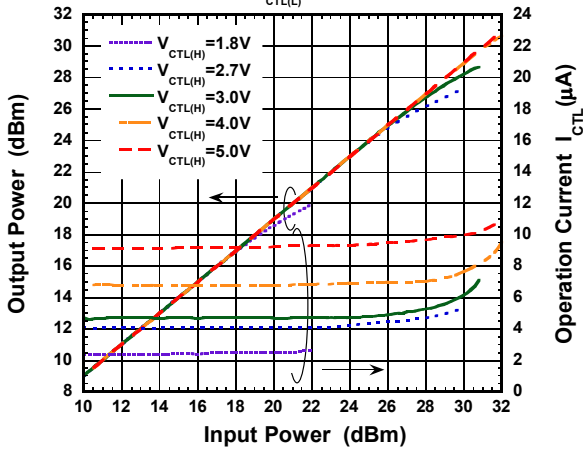

### Loss, ISL vs Input Power

(PC-P1 ON,  $V_{CTL(L)}=0V$ ,  $f=5.9GHz$ )

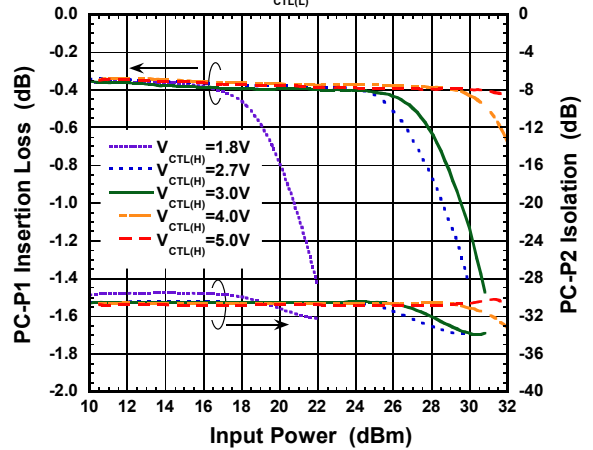

### Output Power, IM3 vs Input Power

(PC-P1 ON,  $V_{CTL(H)}=3.0V$ ,  $V_{CTL(L)}=0V$ ,  $f=2.5GHz+2.501GHz$ )

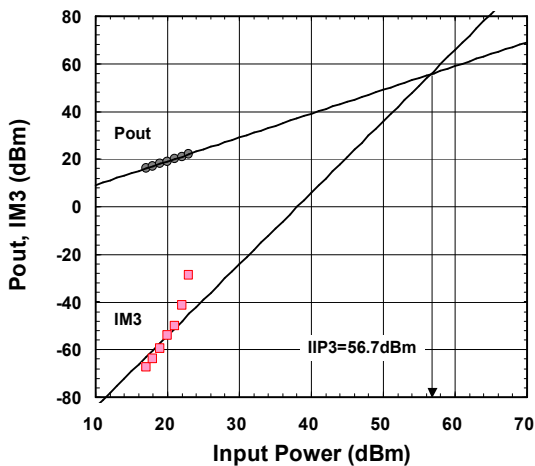

### IIP3 vs Input Power

(PC-P1 ON,  $V_{CTL(L)}=0V$ ,  $f=2.5GHz+2.501GHz$ )

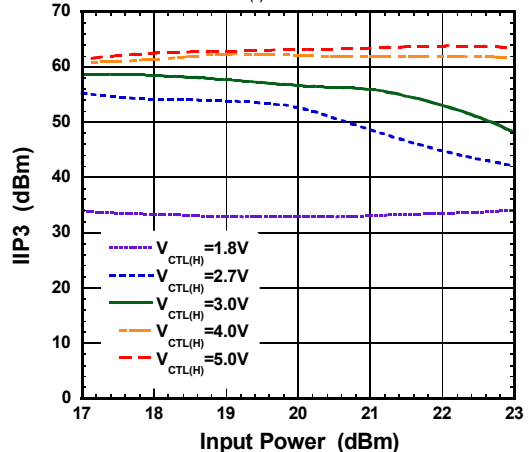

## ■ ELECTRICAL CHARACTERISTICS

### EVM vs Input Power

(PC-P1 ON,  $V_{CTL(L)}=0V$ ,  $f=2.5GHz$ , OFDM 64QAM)

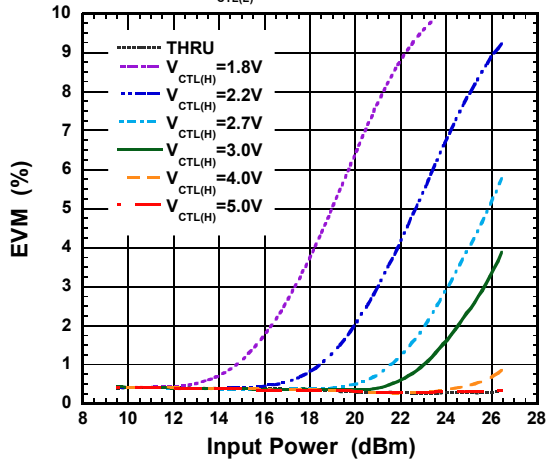

### EVM vs Input Power

(PC-P1 ON,  $V_{CTL(L)}=0V$ ,  $f=5.9GHz$ , OFDM 64QAM)

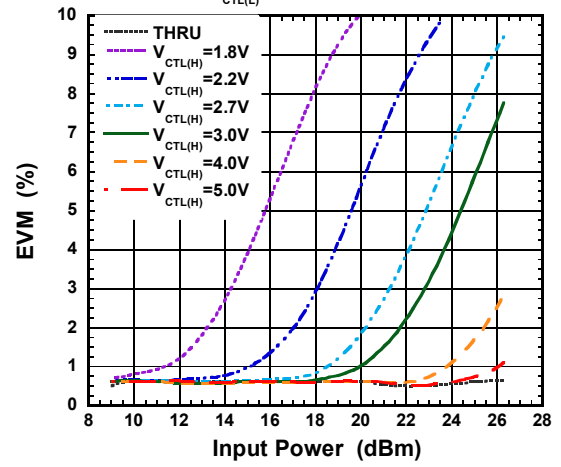

## ■ ELECTRICAL CHARACTERISTICS

### Loss, ISL vs Temperature

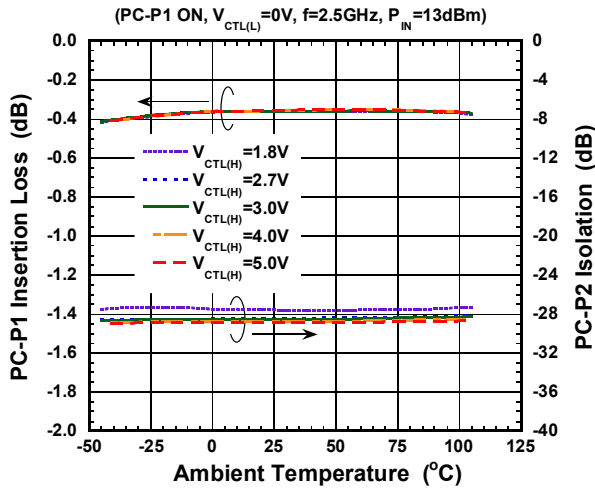

### Loss, ISL vs Temperature

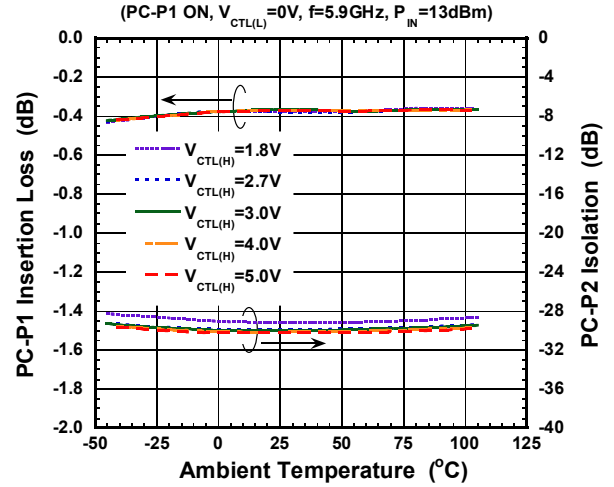

### Return Loss vs Temperature

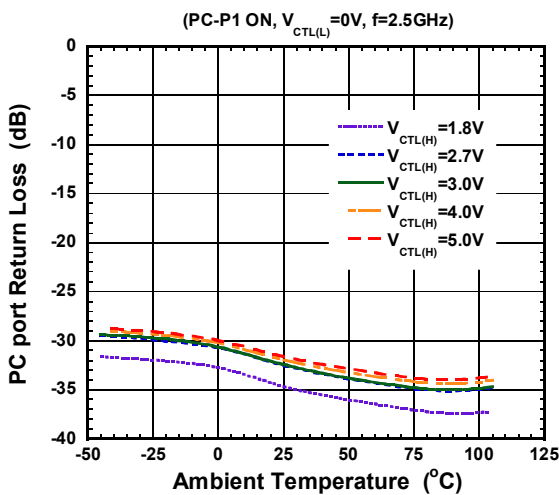

### Return Loss vs Temperature

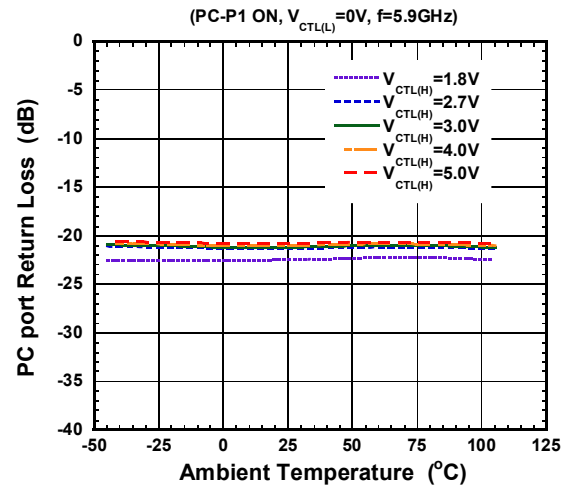

### $P_{-1dB}$ vs Temperature

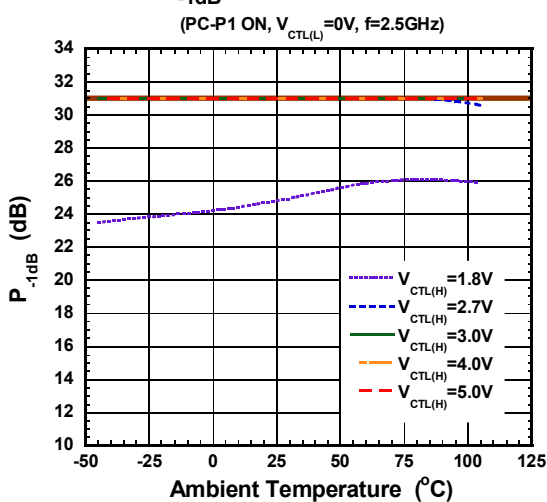

### Switching Time(rise) vs Temperature

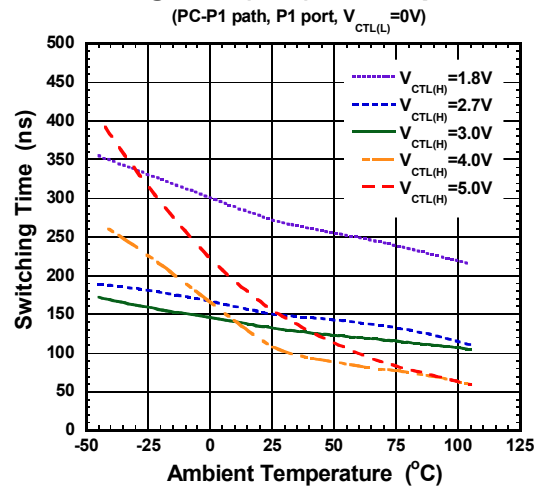



## APPLICATION CIRCUIT

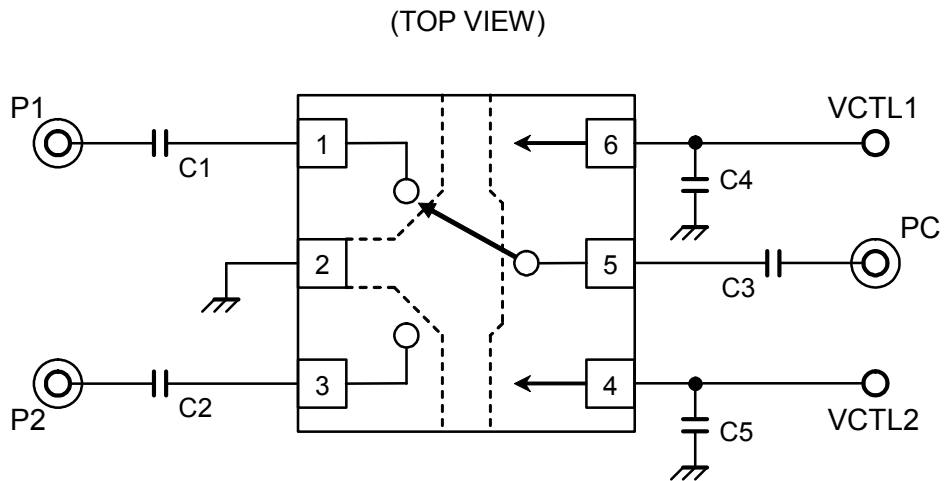

## RECOMMENDED PCB DESIGN

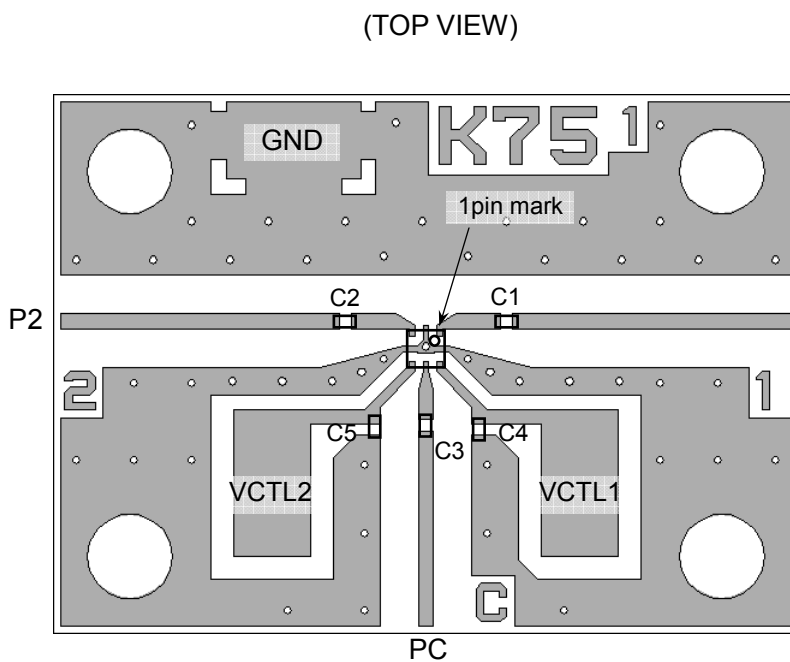

PCB: FR-4, t=0.2mm  
 Capacitor Size: 0603 (0.6 x 0.3 mm)  
 Strip Line Width: 0.4mm  
 PCB Size: 19.4 x 14.0mm  
 Through Hole Diameter: 0.2mm

### Loss of PCB, capacitor and connectors

Frequency (GHz)	Loss (dB)
2.4	0.33
2.5	0.34
4.9	0.55
5.9	0.65

## PARTS LIST

No.	Value	Notes
C1 to C3	27pF	Murata MFG (GRM03 series)
C4 to C5	10pF	

## PCB LAYOUT GUIDELINE

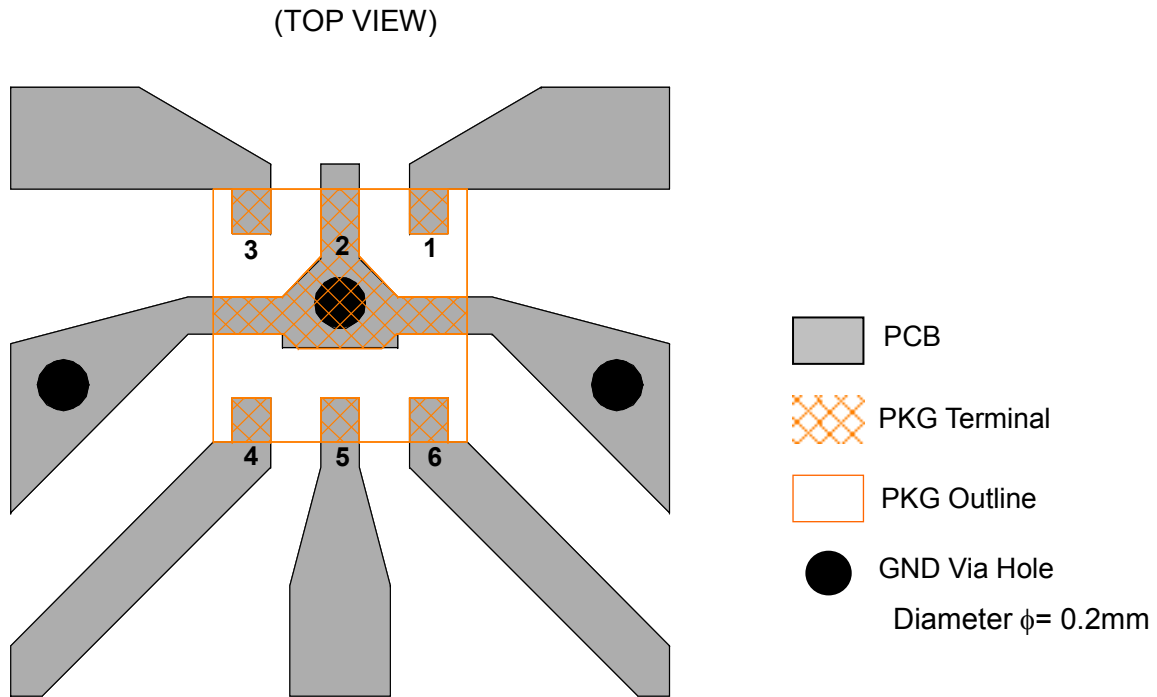

## PRECAUTIONS

- [1] The DC blocking capacitors should be placed at RF terminals. Please choose appropriate capacitance value at the application frequency.
- [2] For good RF performance, exposed pad should be connected to PCB ground plane as close as possible.

## RECOMMENDED FOOTPRINT PATTERN (6pin DFN Package 1.0x1.0mm) <Reference>

Package: 1.0mm x 1.0mm

Pin pitch: 0.35mm

 : Land

 : Mask (Open area) \*Metal mask thickness: 100μm

 : Resist (Open area)

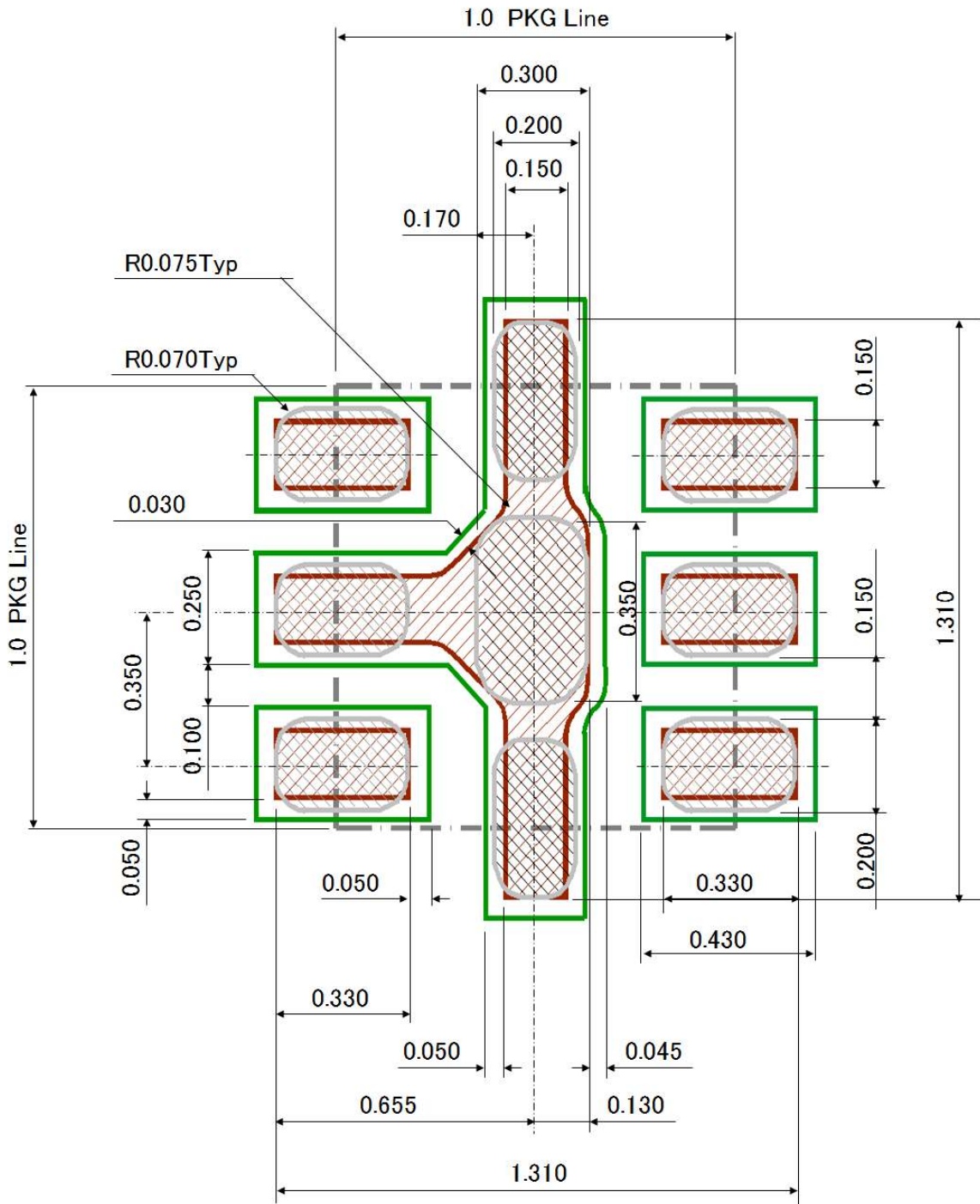

## PACKAGE OUTLINE (DFN6-75)

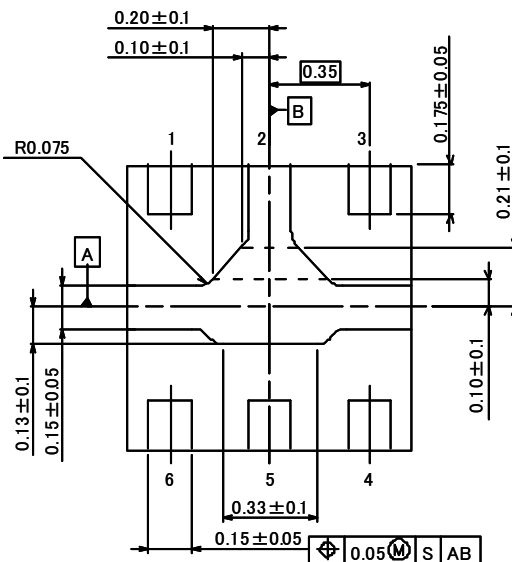
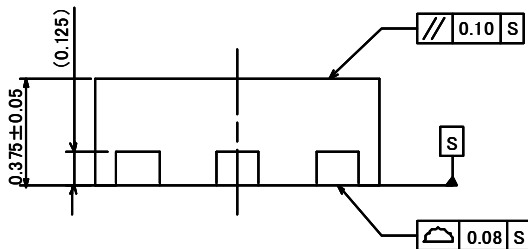
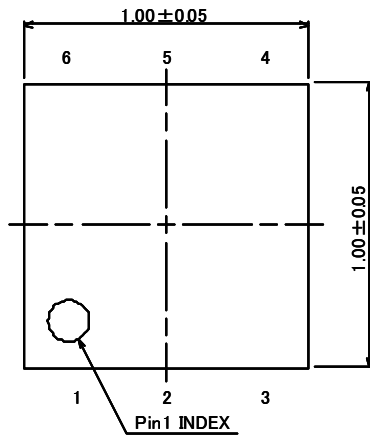

Unit	: mm
Board	: Cu
Terminal Treat	: Ni/Pd/Au
Molding Material	: Epoxy resin
Weight	: 1.2mg

### Cautions on using this product

- This product contains Gallium-Arsenide (GaAs) which is a harmful material.
- Do NOT eat or put into mouth.
- Do NOT dispose in fire or break up this product.
- Do NOT chemically make gas or powder with this product.
- To waste this product, please obey the relating law of your country.

### [CAUTION]

The specifications on this databook are only given for information, without any guarantee as regards either mistakes or omissions. The application circuits in this databook are described only to show representative usages of the product and not intended for the guarantee or permission of any right including the industrial rights.

This product may be damaged with electric static discharge (ESD) or spike voltage. Please handle with care to avoid these damages.

# Mouser Electronics

Authorized Distributor

Click to View Pricing, Inventory, Delivery & Lifecycle Information:

[NJR:](#)

[NJG1801K75](#) [NJG1801K75-TE1](#)

Компания «Океан Электроники» предлагает заключение долгосрочных отношений при поставках импортных электронных компонентов на взаимовыгодных условиях!

Наши преимущества:

- Поставка оригинальных импортных электронных компонентов напрямую с производств Америки, Европы и Азии, а так же с крупнейших складов мира;
- Широкая линейка поставок активных и пассивных импортных электронных компонентов (более 30 млн. наименований);
- Поставка сложных, дефицитных, либо снятых с производства позиций;
- Оперативные сроки поставки под заказ (от 5 рабочих дней);
- Экспресс доставка в любую точку России;
- Помощь Конструкторского Отдела и консультации квалифицированных инженеров;
- Техническая поддержка проекта, помощь в подборе аналогов, поставка прототипов;
- Поставка электронных компонентов под контролем ВП;
- Система менеджмента качества сертифицирована по Международному стандарту ISO 9001;
- При необходимости вся продукция военного и аэрокосмического назначения проходит испытания и сертификацию в лаборатории (по согласованию с заказчиком);
- Поставка специализированных компонентов военного и аэрокосмического уровня качества (Xilinx, Altera, Analog Devices, Intersil, Interpoint, Microsemi, Actel, Aeroflex, Peregrine, VPT, Syfer, Eurofarad, Texas Instruments, MS Kennedy, Miteq, Cobham, E2V, MA-COM, Hittite, Mini-Circuits, General Dynamics и др.);

Компания «Океан Электроники» является официальным дистрибьютором и эксклюзивным представителем в России одного из крупнейших производителей разъемов военного и аэрокосмического назначения «JONHON», а так же официальным дистрибьютором и эксклюзивным представителем в России производителя высокотехнологичных и надежных решений для передачи СВЧ сигналов «FORSTAR».



## JONHON

«JONHON» (основан в 1970 г.)

Разъемы специального, военного и аэрокосмического назначения:

(Применяются в военной, авиационной, аэрокосмической, морской, железнодорожной, горно- и нефтедобывающей отраслях промышленности)

«FORSTAR» (основан в 1998 г.)

ВЧ соединители, коаксиальные кабели, кабельные сборки и микроволновые компоненты:

(Применяются в телекоммуникациях гражданского и специального назначения, в средствах связи, РЛС, а так же военной, авиационной и аэрокосмической отраслях промышленности).



Телефон: 8 (812) 309-75-97 (многоканальный)

Факс: 8 (812) 320-03-32

Электронная почта: [ocean@oceanchips.ru](mailto:ocean@oceanchips.ru)

Web: <http://oceanchips.ru/>

Адрес: 198099, г. Санкт-Петербург, ул. Калинина, д. 2, корп. 4, лит. А