



## SUPER-SMALL PACKAGE HIGH-PRECISION VOLTAGE DETECTOR

[www.sii-ic.com](http://www.sii-ic.com)

© Seiko Instruments Inc., 2001-2011

Rev.6.1\_00

The S-808xxC series is a series of high-precision voltage detectors developed using CMOS process. The detection voltage is fixed internally with an accuracy of  $\pm 2.0\%$ . Two output forms, Nch open-drain and CMOS output, are available. Super-low current consumption and miniature package lineup can meet demand from the portable device applications.

### ■ Features

- Super-low current consumption 1.3  $\mu\text{A}$  typ. (detection voltage  $\leq 1.4$  V, at  $V_{\text{DD}} = 1.5$  V)  
0.8  $\mu\text{A}$  typ. (detection voltage  $\geq 1.5$  V, at  $V_{\text{DD}} = 3.5$  V)
- High-precision detection voltage  $\pm 2.0\%$
- Operating voltage range 0.65 V to 5.0 V (detection voltage  $\leq 1.4$  V)  
0.95 V to 10.0 V (detection voltage  $\geq 1.5$  V)
- Hysteresis characteristics 5% typ.
- Detection voltage 0.8 V to 6.0 V (0.1 V step)
- Output form Nch open-drain output (Active Low)  
CMOS output (Active Low)
- Lead-free, Sn 100%, halogen-free<sup>\*1</sup>

\*1. Refer to “■ Product Name Structure” for details.

### ■ Applications

- Battery checkers
- Power failure detectors
- Power monitor for portable equipments such as pagers, calculators, electronic notebooks and remote controllers.
- Constant voltage power monitor for cameras, video equipments and communication devices.
- Power monitor for microcomputers and reset for CPUs.

### ■ Packages

- SC-82AB
- SOT-23-5
- SOT-89-3
- SNT-4A
- TO-92

■ **Block Diagrams**

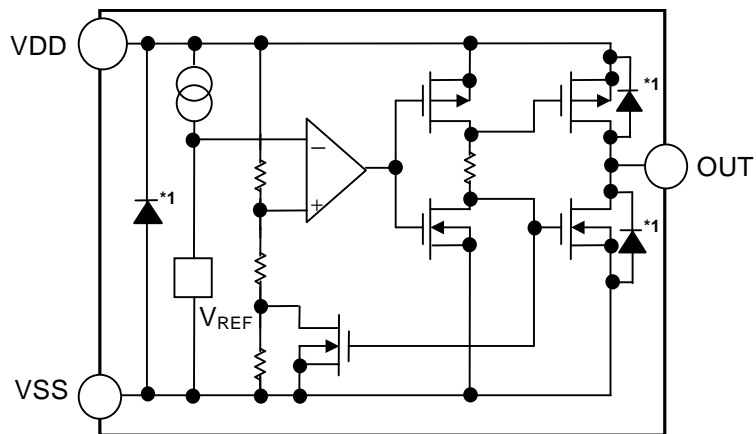
1. Nch Open-drain Output Products



\*1. Parasitic diode

**Figure 1**

2. CMOS Output Products



\*1. Parasitic diode

**Figure 2**

■ **Product Name Structure**

The detection voltage, output form and packages for S-808xxC Series can be selected at the user's request. Refer to the "1. Product Name" for the construction of the product name, "2. Package" regarding the package drawings and "3. Product Name List" for the full product names.

**1. Product Name**

**1-1. SC-82AB, SOT-23-5, SOT-89-3, SNT-4A packages**



\*1. Refer to the tape specifications at the end of this book.

\*2. Refer to the **Table 1 and 3** in the "3. Product Name List"

**1-2. TO-92 package**



**2. Packages**

Package name	Drawing code				
	Package	Tape	Reel	Zigzag	Land
SC-82AB	NP004-A-P-SD	NP004-A-C-SD NP004-A-C-S1	NP004-A-R-SD	—	—
SOT-23-5	MP005-A-P-SD	MP005-A-C-SD	MP005-A-R-SD	—	—
SOT-89-3	UP003-A-P-SD	UP003-A-C-SD	UP003-A-R-SD	—	—
SNT-4A	PF004-A-P-SD	PF004-A-C-SD	PF004-A-R-SD	—	PF004-A-L-SD
TO-92 (Bulk)	YS003-D-P-SD	—	—	—	—
TO-92 (Tape and ammo)	YZ003-E-P-SD	YZ003-E-C-SD	—	YZ003-E-Z-SD	—

**SUPER-SMALL PACKAGE HIGH-PRECISION VOLTAGE DETECTOR**

Rev.6.1\_00

**S-808xxC Series**

**3. Product Name List**

**3-1. Nch Open-drain Output Products**

**Table 1 (1/2)**

Detection voltage range	Hysteresis width (Typ.)	SC-82AB	SOT-23-5	SOT-89-3
0.8 V±2.0 %	0.034 V	S-80808CNNB-B9MT2x	—	—
0.9 V±2.0 %	0.044 V	S-80809CNNB-B9NT2x	—	—
1.0 V±2.0 %	0.054 V	S-80810CNNB-B9OT2x	—	—
1.1 V±2.0 %	0.064 V	S-80811CNNB-B9PT2x	—	—
1.2 V±2.0 %	0.073 V	S-80812CNNB-B9QT2x	—	—
1.3 V±2.0 %	0.083 V	S-80813CNNB-B9RT2x	—	—
1.4 V±2.0 %	0.093 V	S-80814CNNB-B9ST2x	—	—
1.5 V±2.0 %	0.075 V	S-80815CNNB-B8AT2x	S-80815CNMC-B8AT2x	S-80815CNUA-B8AT2x
1.6 V±2.0 %	0.080 V	S-80816CNNB-B8BT2x	S-80816CNMC-B8BT2x	S-80816CNUA-B8BT2x
1.7 V±2.0 %	0.085 V	S-80817CNNB-B8CT2x	S-80817CNMC-B8CT2x	S-80817CNUA-B8CT2x
1.8 V±2.0 %	0.090 V	S-80818CNNB-B8DT2x	S-80818CNMC-B8DT2x	S-80818CNUA-B8DT2x
1.9 V±2.0 %	0.095 V	S-80819CNNB-B8ET2x	S-80819CNMC-B8ET2x	S-80819CNUA-B8ET2x
2.0 V±2.0 %	0.100 V	S-80820CNNB-B8FT2x	S-80820CNMC-B8FT2x	S-80820CNUA-B8FT2x
2.1 V±2.0 %	0.105 V	S-80821CNNB-B8GT2x	S-80821CNMC-B8GT2x	S-80821CNUA-B8GT2x
2.2 V±2.0 %	0.110 V	S-80822CNNB-B8HT2x	S-80822CNMC-B8HT2x	S-80822CNUA-B8HT2x
2.3 V±2.0 %	0.115 V	S-80823CNNB-B8IT2x	S-80823CNMC-B8IT2x	S-80823CNUA-B8IT2x
2.4 V±2.0 %	0.120 V	S-80824CNNB-B8JT2x	S-80824CNMC-B8JT2x	S-80824CNUA-B8JT2x
2.4 V typ.	4.4 ± 0.1 V <sup>*1</sup>	—	—	S-80824KNUA-D2BT2x <sup>*2</sup>
2.5 V±2.0 %	0.125 V	S-80825CNNB-B8KT2x	S-80825CNMC-B8KT2x	S-80825CNUA-B8KT2x
2.6 V±2.0 %	0.130 V	S-80826CNNB-B8LT2x	S-80826CNMC-B8LT2x	S-80826CNUA-B8LT2x
2.7 V±2.0 %	0.135 V	S-80827CNNB-B8MT2x	S-80827CNMC-B8MT2x	S-80827CNUA-B8MT2x
2.8 V±2.0 %	0.140 V	S-80828CNNB-B8NT2x	S-80828CNMC-B8NT2x	S-80828CNUA-B8NT2x
2.9 V±2.0 %	0.145 V	S-80829CNNB-B8OT2x	S-80829CNMC-B8OT2x	S-80829CNUA-B8OT2x
3.0 V±2.0 %	0.150 V	S-80830CNNB-B8PT2x	S-80830CNMC-B8PT2x	S-80830CNUA-B8PT2x
3.1 V±2.0 %	0.155 V	S-80831CNNB-B8QT2x	S-80831CNMC-B8QT2x	S-80831CNUA-B8QT2x
3.2 V±2.0 %	0.160 V	S-80832CNNB-B8RT2x	S-80832CNMC-B8RT2x	S-80832CNUA-B8RT2x
3.3 V±2.0 %	0.165 V	S-80833CNNB-B8ST2x	S-80833CNMC-B8ST2x	S-80833CNUA-B8ST2x
3.4 V±2.0 %	0.170 V	S-80834CNNB-B8TT2x	S-80834CNMC-B8TT2x	S-80834CNUA-B8TT2x
3.5 V±2.0 %	0.175 V	S-80835CNNB-B8UT2x	S-80835CNMC-B8UT2x	S-80835CNUA-B8UT2x
3.6 V±2.0 %	0.180 V	S-80836CNNB-B8VT2x	S-80836CNMC-B8VT2x	S-80836CNUA-B8VT2x
3.7 V±2.0 %	0.185 V	S-80837CNNB-B8WT2x	S-80837CNMC-B8WT2x	S-80837CNUA-B8WT2x
3.8 V±2.0 %	0.190 V	S-80838CNNB-B8XT2x	S-80838CNMC-B8XT2x	S-80838CNUA-B8XT2x
3.9 V±2.0 %	0.195 V	S-80839CNNB-B8YT2x	S-80839CNMC-B8YT2x	S-80839CNUA-B8YT2x

**Table 1 (2/2)**

Detection voltage range	Hysteresis width (Typ.)	SC-82AB	SOT-23-5	SOT-89-3
4.0 V±2.0 %	0.200 V	S-80840CNNB-B8ZT2x	S-80840CNMC-B8ZT2x	S-80840CNUA-B8ZT2x
4.1 V±2.0 %	0.205 V	S-80841CNNB-B82T2x	S-80841CNMC-B82T2x	S-80841CNUA-B82T2x
4.2 V±2.0 %	0.210 V	S-80842CNNB-B83T2x	S-80842CNMC-B83T2x	S-80842CNUA-B83T2x
4.3 V±2.0 %	0.215 V	S-80843CNNB-B84T2x	S-80843CNMC-B84T2x	S-80843CNUA-B84T2x
4.4 V±2.0 %	0.220 V	S-80844CNNB-B85T2x	S-80844CNMC-B85T2x	S-80844CNUA-B85T2x
4.5 V±2.0 %	0.225 V	S-80845CNNB-B86T2x	S-80845CNMC-B86T2x	S-80845CNUA-B86T2x
4.6 V±2.0 %	0.230 V	S-80846CNNB-B87T2x	S-80846CNMC-B87T2x	S-80846CNUA-B87T2x
4.6 V±0.10 V	0.10 V max.	—	—	S-80846KNUA-D2CT2x <sup>*3</sup>
4.7 V±2.0 %	0.235 V	S-80847CNNB-B88T2x	S-80847CNMC-B88T2x	S-80847CNUA-B88T2x
4.8 V±2.0 %	0.240 V	S-80848CNNB-B89T2x	S-80848CNMC-B89T2x	S-80848CNUA-B89T2x
4.9 V±2.0 %	0.245 V	S-80849CNNB-B9AT2x	S-80849CNMC-B9AT2x	S-80849CNUA-B9AT2x
5.0 V±2.0 %	0.250 V	S-80850CNNB-B9BT2x	S-80850CNMC-B9BT2x	S-80850CNUA-B9BT2x
5.1 V±2.0 %	0.255 V	S-80851CNNB-B9CT2x	S-80851CNMC-B9CT2x	S-80851CNUA-B9CT2x
5.2 V±2.0 %	0.260 V	S-80852CNNB-B9DT2x	S-80852CNMC-B9DT2x	S-80852CNUA-B9DT2x
5.3 V±2.0 %	0.265 V	S-80853CNNB-B9ET2x	S-80853CNMC-B9ET2x	S-80853CNUA-B9ET2x
5.4 V±2.0 %	0.270 V	S-80854CNNB-B9FT2x	S-80854CNMC-B9FT2x	S-80854CNUA-B9FT2x
5.5 V±2.0 %	0.275 V	S-80855CNNB-B9GT2x	S-80855CNMC-B9GT2x	S-80855CNUA-B9GT2x
5.6 V±2.0 %	0.280 V	S-80856CNNB-B9HT2x	S-80856CNMC-B9HT2x	S-80856CNUA-B9HT2x
5.7 V±2.0 %	0.285 V	S-80857CNNB-B9IT2x	S-80857CNMC-B9IT2x	S-80857CNUA-B9IT2x
5.8 V±2.0 %	0.290 V	S-80858CNNB-B9JT2x	S-80858CNMC-B9JT2x	S-80858CNUA-B9JT2x
5.9 V±2.0 %	0.295 V	S-80859CNNB-B9KT2x	S-80859CNMC-B9KT2x	S-80859CNUA-B9KT2x
6.0 V±2.0 %	0.300 V	S-80860CNNB-B9LT2x	S-80860CNMC-B9LT2x	S-80860CNUA-B9LT2x

\*1. Describes the release voltage.

\*2. Refer to the **Table 18** in “■ Electrical Characteristics for Customized Products” for electrical characteristics.

\*3. Refer to the **Table 20** in “■ Electrical Characteristics for Customized Products” for electrical characteristics

**Remark 1.** x: G or U

2. Please select products of environmental code = U for Sn 100%, halogen-free products.

**SUPER-SMALL PACKAGE HIGH-PRECISION VOLTAGE DETECTOR**

Rev.6.1\_00

**S-808xxC Series**

**Table 2 (1/2)**

Detection voltage range	Hysteresis width (Typ.)	SNT-4A	TO-92 <sup>*1</sup>
0.8 V±2.0 %	0.034 V	S-80808CNPFB-B9MTFx	—
0.9 V±2.0 %	0.044 V	S-80809CNPFB-B9NTFx	—
1.0 V±2.0 %	0.054 V	S-80810CNPFB-B9OTFx	—
1.1 V±2.0 %	0.064 V	S-80811CNPFB-B9PTFx	—
1.2 V±2.0 %	0.073 V	S-80812CNPFB-B9QTFx	—
1.3 V±2.0 %	0.083 V	S-80813CNPFB-B9RTFx	—
1.4 V±2.0 %	0.093 V	S-80814CNPFB-B9STFx	—
1.5 V±2.0 %	0.075 V	S-80815CNPFB-B8ATFx	S-80815CNY-n2-U
1.6 V±2.0 %	0.080 V	S-80816CNPFB-B8BTFx	S-80816CNY-n2-U
1.7 V±2.0 %	0.085 V	S-80817CNPFB-B8CTFx	S-80817CNY-n2-U
1.8 V±2.0 %	0.090 V	S-80818CNPFB-B8DTFx	S-80818CNY-n2-U
1.9 V±2.0 %	0.095 V	S-80819CNPFB-B8ETFx	S-80819CNY-n2-U
2.0 V±2.0 %	0.100 V	S-80820CNPFB-B8FTFx	S-80820CNY-n2-U
2.1 V±2.0 %	0.105 V	S-80821CNPFB-B8GTFx	S-80821CNY-n2-U
2.2 V±2.0 %	0.110 V	S-80822CNPFB-B8HTFx	S-80822CNY-n2-U
2.3 V±2.0 %	0.115 V	S-80823CNPFB-B8ITFx	S-80823CNY-n2-U
2.4 V±2.0 %	0.120 V	S-80824CNPFB-B8JTFx	S-80824CNY-n2-U
2.4 V typ.	4.4 ± 0.1 V <sup>*2</sup>	—	S-80824KNY-n2-U <sup>*3</sup>
2.5 V±2.0 %	0.125 V	S-80825CNPFB-B8KTFx	S-80825CNY-n2-U
2.6 V±2.0 %	0.130 V	S-80826CNPFB-B8LTFx	S-80826CNY-n2-U
2.7 V±2.0 %	0.135 V	S-80827CNPFB-B8MTFx	S-80827CNY-n2-U
2.8 V±2.0 %	0.140 V	S-80828CNPFB-B8NTFx	S-80828CNY-n2-U
2.9 V±2.0 %	0.145 V	S-80829CNPFB-B8OTFx	S-80829CNY-n2-U
3.0 V±2.0 %	0.150 V	S-80830CNPFB-B8PTFx	S-80830CNY-n2-U
3.1 V±2.0 %	0.155 V	S-80831CNPFB-B8QTFx	S-80831CNY-n2-U
3.2 V±2.0 %	0.160 V	S-80832CNPFB-B8RTFx	S-80832CNY-n2-U
3.3 V±2.0 %	0.165 V	S-80833CNPFB-B8STFx	S-80833CNY-n2-U
3.4 V±2.0 %	0.170 V	S-80834CNPFB-B8TTFx	S-80834CNY-n2-U
3.5 V±2.0 %	0.175 V	S-80835CNPFB-B8UTFx	S-80835CNY-n2-U
3.6 V±2.0 %	0.180 V	S-80836CNPFB-B8VTFx	S-80836CNY-n2-U
3.7 V±2.0 %	0.185 V	S-80837CNPFB-B8WTFx	S-80837CNY-n2-U
3.8 V±2.0 %	0.190 V	S-80838CNPFB-B8XTFx	S-80838CNY-n2-U
3.9 V±2.0 %	0.195 V	S-80839CNPFB-B8YTFx	S-80839CNY-n2-U
4.0 V±2.0 %	0.200 V	S-80840CNPFB-B8ZTFx	S-80840CNY-n2-U
4.1 V±2.0 %	0.205 V	S-80841CNPFB-B82TFx	S-80841CNY-n2-U
4.2 V±2.0 %	0.210 V	S-80842CNPFB-B83TFx	S-80842CNY-n2-U
4.3 V±2.0 %	0.215 V	S-80843CNPFB-B84TFx	S-80843CNY-n2-U
4.4 V±2.0 %	0.220 V	S-80844CNPFB-B85TFx	S-80844CNY-n2-U
4.5 V±2.0 %	0.225 V	S-80845CNPFB-B86TFx	S-80845CNY-n2-U
4.6 V±2.0 %	0.230 V	S-80846CNPFB-B87TFx	S-80846CNY-n2-U
4.6 V±0.10 V	0.10 V max.	—	S-80846KNY-n2-U <sup>*4</sup>
4.7 V±2.0 %	0.235 V	S-80847CNPFB-B88TFx	S-80847CNY-n2-U
4.8 V±2.0 %	0.240 V	S-80848CNPFB-B89TFx	S-80848CNY-n2-U
4.9 V±2.0 %	0.245 V	S-80849CNPFB-B9ATFx	S-80849CNY-n2-U
5.0 V±2.0 %	0.250 V	S-80850CNPFB-B9BTFx	S-80850CNY-n2-U
5.1 V±2.0 %	0.255 V	S-80851CNPFB-B9CTFx	S-80851CNY-n2-U

**Table 2 (2/2)**

Detection voltage range	Hysteresis width (Typ.)	SNT-4A	TO-92*1
5.2 V±2.0 %	0.260 V	S-80852CNPF-B9DTFx	S-80852CNY-n2-U
5.3 V±2.0 %	0.265 V	S-80853CNPF-B9ETFx	S-80853CNY-n2-U
5.4 V±2.0 %	0.270 V	S-80854CNPF-B9FTFx	S-80854CNY-n2-U
5.5 V±2.0 %	0.275 V	S-80855CNPF-B9GTFx	S-80855CNY-n2-U
5.6 V±2.0 %	0.280 V	S-80856CNPF-B9HTFx	S-80856CNY-n2-U
5.7 V±2.0 %	0.285 V	S-80857CNPF-B9ITFx	S-80857CNY-n2-U
5.8 V±2.0 %	0.290 V	S-80858CNPF-B9JTFx	S-80858CNY-n2-U
5.9 V±2.0 %	0.295 V	S-80859CNPF-B9KTFx	S-80859CNY-n2-U
6.0 V±2.0 %	0.300 V	S-80860CNPF-B9LTFx	S-80860CNY-n2-U

\*1. n changes according to the packing form in TO-92. B: Bulk, Z: Tape and ammo

\*2. Describes the release voltage.

\*3. Refer to the **Table 18** in “■ Electrical Characteristics for Customized Products” for electrical characteristics.

\*4. Refer to the **Table 20** in “■ Electrical Characteristics for Customized Products” for electrical characteristics.

**Remark 1.** x: G or U

2. Please select products of environmental code = U for Sn 100%, halogen-free products.



# SUPER-SMALL PACKAGE HIGH-PRECISION VOLTAGE DETECTOR

Rev.6.1\_00

S-808xxC Series

## 3-2. CMOS Output Products

Table 3 (1/2)

Detection voltage range	Hysteresis width (Typ.)	SC-82AB	SOT-23-5	SOT-89-3
0.8 V±2.0 %	0.034 V	S-80808CLNB-B7MT2x	—	—
0.9 V±2.0 %	0.044 V	S-80809CLNB-B7NT2x	—	—
1.0 V±2.0 %	0.054 V	S-80810CLNB-B7OT2x	—	—
1.1 V±2.0 %	0.064 V	S-80811CLNB-B7PT2x	—	—
1.2 V±2.0 %	0.073 V	S-80812CLNB-B7QT2x	—	—
1.3 V±2.0 %	0.083 V	S-80813CLNB-B7RT2x	—	—
1.4 V±2.0 %	0.093 V	S-80814CLNB-B7ST2x	—	—
1.5 V±2.0 %	0.075 V	S-80815CLNB-B6AT2x	S-80815CLMC-B6AT2x	S-80815CLUA-B6AT2x
1.6 V±2.0 %	0.080 V	S-80816CLNB-B6BT2x	S-80816CLMC-B6BT2x	S-80816CLUA-B6BT2x
1.7 V±2.0 %	0.085 V	S-80817CLNB-B6CT2x	S-80817CLMC-B6CT2x	S-80817CLUA-B6CT2x
1.8 V±2.0 %	0.090 V	S-80818CLNB-B6DT2x	S-80818CLMC-B6DT2x	S-80818CLUA-B6DT2x
1.9 V±2.0 %	0.095 V	S-80819CLNB-B6ET2x	S-80819CLMC-B6ET2x	S-80819CLUA-B6ET2x
2.0 V±2.0 %	0.100 V	S-80820CLNB-B6FT2x	S-80820CLMC-B6FT2x	S-80820CLUA-B6FT2x
2.1 V±2.0 %	0.105 V	S-80821CLNB-B6GT2x	S-80821CLMC-B6GT2x	S-80821CLUA-B6GT2x
2.2 V±2.0 %	0.110 V	S-80822CLNB-B6HT2x	S-80822CLMC-B6HT2x	S-80822CLUA-B6HT2x
2.3 V±2.0 %	0.115 V	S-80823CLNB-B6IT2x	S-80823CLMC-B6IT2x	S-80823CLUA-B6IT2x
2.4 V±2.0 %	0.120 V	S-80824CLNB-B6JT2x	S-80824CLMC-B6JT2x	S-80824CLUA-B6JT2x
2.5 V±2.0 %	0.125 V	S-80825CLNB-B6KT2x	S-80825CLMC-B6KT2x	S-80825CLUA-B6KT2x
2.6 V±2.0 %	0.130 V	S-80826CLNB-B6LT2x	S-80826CLMC-B6LT2x	S-80826CLUA-B6LT2x
2.7 V±2.0 %	0.135 V	S-80827CLNB-B6MT2x	S-80827CLMC-B6MT2x	S-80827CLUA-B6MT2x
2.8 V±2.0 %	0.140 V	S-80828CLNB-B6NT2x	S-80828CLMC-B6NT2x	S-80828CLUA-B6NT2x
2.9 V±2.0 %	0.145 V	S-80829CLNB-B6OT2x	S-80829CLMC-B6OT2x	S-80829CLUA-B6OT2x
3.0 V±2.0 %	0.150 V	S-80830CLNB-B6PT2x	S-80830CLMC-B6PT2x	S-80830CLUA-B6PT2x
3.1 V±2.0 %	0.155 V	S-80831CLNB-B6QT2x	S-80831CLMC-B6QT2x	S-80831CLUA-B6QT2x
3.2 V±2.0 %	0.160 V	S-80832CLNB-B6RT2x	S-80832CLMC-B6RT2x	S-80832CLUA-B6RT2x
3.3 V±2.0 %	0.165 V	S-80833CLNB-B6ST2x	S-80833CLMC-B6ST2x	S-80833CLUA-B6ST2x
3.4 V±2.0 %	0.170 V	S-80834CLNB-B6TT2x	S-80834CLMC-B6TT2x	S-80834CLUA-B6TT2x
3.5 V±2.0 %	0.175 V	S-80835CLNB-B6UT2x	S-80835CLMC-B6UT2x	S-80835CLUA-B6UT2x
3.6 V±2.0 %	0.180 V	S-80836CLNB-B6VT2x	S-80836CLMC-B6VT2x	S-80836CLUA-B6VT2x
3.7 V±2.0 %	0.185 V	S-80837CLNB-B6WT2x	S-80837CLMC-B6WT2x	S-80837CLUA-B6WT2x
3.8 V±2.0 %	0.190 V	S-80838CLNB-B6XT2x	S-80838CLMC-B6XT2x	S-80838CLUA-B6XT2x
3.9 V±2.0 %	0.195 V	S-80839CLNB-B6YT2x	S-80839CLMC-B6YT2x	S-80839CLUA-B6YT2x
4.0 V±2.0 %	0.200 V	S-80840CLNB-B6ZT2x	S-80840CLMC-B6ZT2x	S-80840CLUA-B6ZT2x
4.1 V±2.0 %	0.205 V	S-80841CLNB-B62T2x	S-80841CLMC-B62T2x	S-80841CLUA-B62T2x
4.2 V±2.0 %	0.210 V	S-80842CLNB-B63T2x	S-80842CLMC-B63T2x	S-80842CLUA-B63T2x
4.3 V±2.0 %	0.215 V	S-80843CLNB-B64T2x	S-80843CLMC-B64T2x	S-80843CLUA-B64T2x
4.4 V±2.0 %	0.220 V	S-80844CLNB-B65T2x	S-80844CLMC-B65T2x	S-80844CLUA-B65T2x
4.45 V typ.	4.70 V max.*1	—	—	S-80844KLUA-D2AT2x*2
4.5 V±2.0 %	0.225 V	S-80845CLNB-B66T2x	S-80845CLMC-B66T2x	S-80845CLUA-B66T2x
4.6 V±2.0 %	0.230 V	S-80846CLNB-B67T2x	S-80846CLMC-B67T2x	S-80846CLUA-B67T2x
4.7 V±2.0 %	0.235 V	S-80847CLNB-B68T2x	S-80847CLMC-B68T2x	S-80847CLUA-B68T2x
4.8 V±2.0 %	0.240 V	S-80848CLNB-B69T2x	S-80848CLMC-B69T2x	S-80848CLUA-B69T2x
4.9 V±2.0 %	0.245 V	S-80849CLNB-B7AT2x	S-80849CLMC-B7AT2x	S-80849CLUA-B7AT2x
5.0 V±2.0 %	0.250 V	S-80850CLNB-B7BT2x	S-80850CLMC-B7BT2x	S-80850CLUA-B7BT2x
5.1 V±2.0 %	0.255 V	S-80851CLNB-B7CT2x	S-80851CLMC-B7CT2x	S-80851CLUA-B7CT2x

**Table 3 (2/2)**

Detection voltage range	Hysteresis width (Typ.)	SC-82AB	SOT-23-5	SOT-89-3
5.2 V±2.0 %	0.260 V	S-80852CLNB-B7DT2x	S-80852CLMC-B7DT2x	S-80852CLUA-B7DT2x
5.3 V±2.0 %	0.265 V	S-80853CLNB-B7ET2x	S-80853CLMC-B7ET2x	S-80853CLUA-B7ET2x
5.4 V±2.0 %	0.270 V	S-80854CLNB-B7FT2x	S-80854CLMC-B7FT2x	S-80854CLUA-B7FT2x
5.5 V±2.0 %	0.275 V	S-80855CLNB-B7GT2x	S-80855CLMC-B7GT2x	S-80855CLUA-B7GT2x
5.6 V±2.0 %	0.280 V	S-80856CLNB-B7HT2x	S-80856CLMC-B7HT2x	S-80856CLUA-B7HT2x
5.7 V±2.0 %	0.285 V	S-80857CLNB-B7IT2x	S-80857CLMC-B7IT2x	S-80857CLUA-B7IT2x
5.8 V±2.0 %	0.290 V	S-80858CLNB-B7JT2x	S-80858CLMC-B7JT2x	S-80858CLUA-B7JT2x
5.9 V±2.0 %	0.295 V	S-80859CLNB-B7KT2x	S-80859CLMC-B7KT2x	S-80859CLUA-B7KT2x
6.0 V±2.0 %	0.300 V	S-80860CLNB-B7LT2x	S-80860CLMC-B7LT2x	S-80860CLUA-B7LT2x

\*1. Describes the release voltage.

\*2. Refer to the **Table 19** in “■ Electrical Characteristics for Customized Products” for electrical characteristics.

**Remark 1.** x: G or U

2. Please select products of environmental code = U for Sn 100%, halogen-free products.

**Table 4 (1/2)**

Detection voltage range	Hysteresis width (Typ.)	SNT-4A	TO-92 <sup>*1</sup>
0.8 V±2.0 %	0.034 V	S-80808CLPF-B7MTFx	—
0.9 V±2.0 %	0.044 V	S-80809CLPF-B7NTFx	—
1.0 V±2.0 %	0.054 V	S-80810CLPF-B7OTFx	—
1.1 V±2.0 %	0.064 V	S-80811CLPF-B7PTFx	—
1.2 V±2.0 %	0.073 V	S-80812CLPF-B7QTFx	—
1.3 V±2.0 %	0.083 V	S-80813CLPF-B7RTFx	—
1.4 V±2.0 %	0.093 V	S-80814CLPF-B7STFx	—
1.5 V±2.0 %	0.075 V	S-80815CLPF-B6ATFx	S-80815CLY-n2-U
1.6 V±2.0 %	0.080 V	S-80816CLPF-B6BTFx	S-80816CLY-n2-U
1.7 V±2.0 %	0.085 V	S-80817CLPF-B6CTFx	S-80817CLY-n2-U
1.8 V±2.0 %	0.090 V	S-80818CLPF-B6DTFx	S-80818CLY-n2-U
1.9 V±2.0 %	0.095 V	S-80819CLPF-B6ETFx	S-80819CLY-n2-U
2.0 V±2.0 %	0.100 V	S-80820CLPF-B6FTFx	S-80820CLY-n2-U
2.1 V±2.0 %	0.105 V	S-80821CLPF-B6GTFx	S-80821CLY-n2-U
2.2 V±2.0 %	0.110 V	S-80822CLPF-B6HTFx	S-80822CLY-n2-U
2.3 V±2.0 %	0.115 V	S-80823CLPF-B6ITFx	S-80823CLY-n2-U
2.4 V±2.0 %	0.120 V	S-80824CLPF-B6JTFx	S-80824CLY-n2-U
2.5 V±2.0 %	0.125 V	S-80825CLPF-B6KTFx	S-80825CLY-n2-U
2.6 V±2.0 %	0.130 V	S-80826CLPF-B6LTFx	S-80826CLY-n2-U
2.7 V±2.0 %	0.135 V	S-80827CLPF-B6MTFx	S-80827CLY-n2-U
2.8 V±2.0 %	0.140 V	S-80828CLPF-B6NTFx	S-80828CLY-n2-U
2.9 V±2.0 %	0.145 V	S-80829CLPF-B6OTFx	S-80829CLY-n2-U
3.0 V±2.0 %	0.150 V	S-80830CLPF-B6PTFx	S-80830CLY-n2-U
3.1 V±2.0 %	0.155 V	S-80831CLPF-B6QTFx	S-80831CLY-n2-U
3.2 V±2.0 %	0.160 V	S-80832CLPF-B6RTFx	S-80832CLY-n2-U
3.3 V±2.0 %	0.165 V	S-80833CLPF-B6STFx	S-80833CLY-n2-U
3.4 V±2.0 %	0.170 V	S-80834CLPF-B6TTFx	S-80834CLY-n2-U
3.5 V±2.0 %	0.175 V	S-80835CLPF-B6UTFx	S-80835CLY-n2-U
3.6 V±2.0 %	0.180 V	S-80836CLPF-B6VTFx	S-80836CLY-n2-U
3.7 V±2.0 %	0.185 V	S-80837CLPF-B6WTFx	S-80837CLY-n2-U
3.8 V±2.0 %	0.190 V	S-80838CLPF-B6XTFx	S-80838CLY-n2-U

**SUPER-SMALL PACKAGE HIGH-PRECISION VOLTAGE DETECTOR**  
**S-808xxC Series**

Rev.6.1\_00

**Table 4 (2/2)**

Detection voltage range	Hysteresis width (Typ.)	SNT-4A	TO-92 <sup>*1</sup>
3.9 V±2.0 %	0.195 V	S-80839CLPF-B6YTFx	S-80839CLY-n2-U
4.0 V±2.0 %	0.200 V	S-80840CLPF-B6ZTFx	S-80840CLY-n2-U
4.1 V±2.0 %	0.205 V	S-80841CLPF-B62TFx	S-80841CLY-n2-U
4.2 V±2.0 %	0.210 V	S-80842CLPF-B63TFx	S-80842CLY-n2-U
4.3 V±2.0 %	0.215 V	S-80843CLPF-B64TFx	S-80843CLY-n2-U
4.4 V±2.0 %	0.220 V	S-80844CLPF-B65TFx	S-80844CLY-n2-U
4.45 V typ.	4.70 V max. <sup>*2</sup>	—	S-80844KLY-n2-U <sup>*3</sup>
4.5 V±2.0 %	0.225 V	S-80845CLPF-B66TFx	S-80845CLY-n2-U
4.6 V±2.0 %	0.230 V	S-80846CLPF-B67TFx	S-80846CLY-n2-U
4.7 V±2.0 %	0.235 V	S-80847CLPF-B68TFx	S-80847CLY-n2-U
4.8 V±2.0 %	0.240 V	S-80848CLPF-B69TFx	S-80848CLY-n2-U
4.9 V±2.0 %	0.245 V	S-80849CLPF-B7ATFx	S-80849CLY-n2-U
5.0 V±2.0 %	0.250 V	S-80850CLPF-B7BTFx	S-80850CLY-n2-U
5.1 V±2.0 %	0.255 V	S-80851CLPF-B7CTFx	S-80851CLY-n2-U
5.2 V±2.0 %	0.260 V	S-80852CLPF-B7DTFx	S-80852CLY-n2-U
5.3 V±2.0 %	0.265 V	S-80853CLPF-B7ETFx	S-80853CLY-n2-U
5.4 V±2.0 %	0.270 V	S-80854CLPF-B7FTFx	S-80854CLY-n2-U
5.5 V±2.0 %	0.275 V	S-80855CLPF-B7GTFx	S-80855CLY-n2-U
5.6 V±2.0 %	0.280 V	S-80856CLPF-B7HTFx	S-80856CLY-n2-U
5.7 V±2.0 %	0.285 V	S-80857CLPF-B7ITFx	S-80857CLY-n2-U
5.8 V±2.0 %	0.290 V	S-80858CLPF-B7JTFx	S-80858CLY-n2-U
5.9 V±2.0 %	0.295 V	S-80859CLPF-B7KTFx	S-80859CLY-n2-U
6.0 V±2.0 %	0.300 V	S-80860CLPF-B7LTFx	S-80860CLY-n2-U

\*1. n changes according to the packing form in TO-92. B: Bulk, Z: Tape and ammo

\*2. Describes the release voltage.

\*3. Refer to the **Table 19** in “■ Electrical Characteristics for Customized Products” for electrical characteristics.

**Remark 1.** x: G or U

2. Please select products of environmental code = U for Sn 100%, halogen-free products.

■ **Output Forms**

1. **Output Forms in S-808xxC Series**

**Table 5**

	Nch open-drain output products (Active Low)	CMOS output products (Active Low)
S-808xxC Series	“N” is the last letter of the product name. e.g. S-80815CN	“L” is the last letter of the product name. e.g. S-80815CL

2. **Output Forms and Their Usage**

**Table 6**

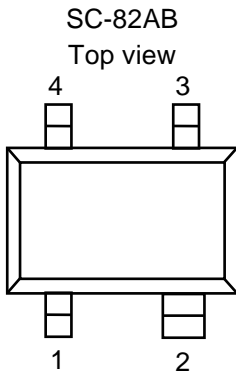
Usage	Nch open-drain output products (Active Low)	CMOS output products (Active Low)
Different power supplies	Yes	No
Active Low reset for CPUs	Yes	Yes
Active High reset for CPUs	No	No
Detection voltage change by resistor divider	Yes	No

- Example for two power supplies
- Example for one power supply

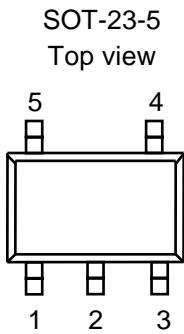


**Figure 3**

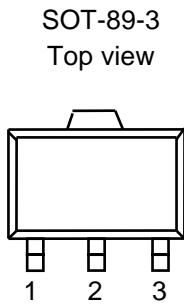
■ **Pin Configurations**



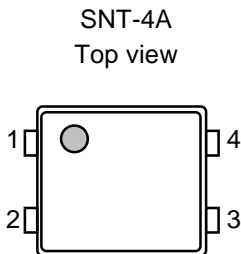
**Figure 4**



**Figure 5**



**Figure 6**



**Figure 7**

**Table 7**

Pin No.	Symbol	Description
1	OUT	Voltage detection output pin
2	VDD	Voltage input pin
3	NC <sup>*1</sup>	No connection
4	VSS	GND pin

\*1. The NC pin is electrically open.  
 The NC pin can be connected to VDD or VSS.

**Table 8**

Pin No.	Symbol	Description
1	OUT	Voltage detection output pin
2	VDD	Voltage input pin
3	VSS	GND pin
4	NC <sup>*1</sup>	No connection
5	NC <sup>*1</sup>	No connection

\*1. The NC pin is electrically open.  
 The NC pin can be connected to VDD or VSS.

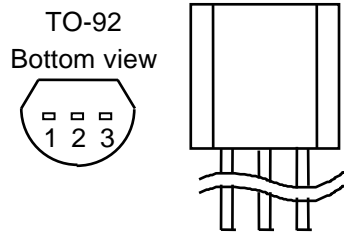
**Table 9**

Pin No.	Symbol	Description
1	OUT	Voltage detection output pin
2	VDD	Voltage input pin
3	VSS	GND pin

**Table 10**

Pin No.	Symbol	Description
1	OUT	Voltage detection output pin
2	VSS	GND pin
3	NC <sup>*1</sup>	No connection
4	VDD	Voltage input pin

\*1. The NC pin is electrically open.  
 The NC pin can be connected to VDD or VSS.



**Figure 8**

**Table 11**

Pin No.	Symbol	Description
1	OUT	Voltage detection output pin
2	VDD	Voltage input pin
3	VSS	GND pin

■ **Absolute Maximum Ratings**

1. **Detection Voltage Typ. 1.4 V or Less Products**

**Table 12**

(Ta = 25 °C unless otherwise specified)

Item		Symbol	Absolute maximum ratings	Unit
Power supply voltage		$V_{DD}-V_{SS}$	7	V
Output voltage	Nch open-drain output products	$V_{OUT}$	$V_{SS}-0.3$ to $V_{SS}+7$	V
	CMOS output products		$V_{SS}-0.3$ to $V_{DD}+0.3$	V
Output current		$I_{OUT}$	50	mA
Power dissipation	SC-82AB	$P_D$	150 (When not mounted on board)	mW
			350 <sup>*1</sup>	mW
	SNT-4A		140 (When not mounted on board)	mW
			300 <sup>*1</sup>	mW
Operating ambient temperature		$T_{opr}$	-40 to +85	°C
Storage temperature		$T_{stg}$	-40 to +125	°C

\*1. When mounted on board  
 [Mounted board]

- (1) Board size: 114.3 mm × 76.2 mm × t1.6 mm
- (2) Board name: JEDEC STANDARD51-7

**Caution** The absolute maximum ratings are rated values exceeding which the product could suffer physical damage. These values must therefore not be exceeded under any conditions.



**Figure 9 Power Dissipation of Package (When Mounted on Board)**

**2. Detection Voltage Typ. 1.5 V or More Products**

**Table 13**

(Ta = 25 °C unless otherwise specified)

Item		Symbol	Absolute maximum ratings	Unit
Power supply voltage		$V_{DD}-V_{SS}$	12	V
Output voltage	Nch open-drain output products	$V_{OUT}$	$V_{SS}-0.3$ to $V_{SS}+12$	V
	CMOS output products		$V_{SS}-0.3$ to $V_{DD}+0.3$	V
Output current		$I_{OUT}$	50	mA
Power dissipation	SC-82AB	$P_D$	150 (When not mounted on board)	mW
			350 <sup>*1</sup>	mW
	SOT-23-5		250 (When not mounted on board)	mW
			600 <sup>*1</sup>	mW
	SOT-89-3		500 (When not mounted on board)	mW
			1000 <sup>*1</sup>	mW
	SNT-4A		140 (When not mounted on board)	mW
	300 <sup>*1</sup>	mW		
	TO-92		400 (When not mounted on board)	mW
			800 <sup>*1</sup>	mW
Operating ambient temperature		$T_{opr}$	-40 to +85	°C
Storage temperature		$T_{stg}$	-40 to +125	°C

\*1. When mounted on board

[Mounted board]

(1) Board size: 114.3 mm × 76.2 mm × t1.6 mm

(2) Board name: JEDEC STANDARD51-7

**Caution** The absolute maximum ratings are rated values exceeding which the product could suffer physical damage. These values must therefore not be exceeded under any conditions.



**Figure 10 Power Dissipation of Package (When Mounted on Board)**



■ **Electrical Characteristics**

1. **Nch Open-drain Output Products**

1-1. **Detection Voltage Typ.1.4 V or Less Products**

**Table 14**

(Ta = 25 °C unless otherwise specified)

Item	Symbol	Condition	Min.	Typ.	Max.	Unit	Test circuit
Detection voltage*1	$-V_{DET}$	—	$-V_{DET(S)} \times 0.98$	$-V_{DET(S)}$	$-V_{DET(S)} \times 1.02$	V	1
Release voltage	$+V_{DET}$	S-80808	0.802	0.834	0.867	V	1
		S-80809	0.910	0.944	0.979	V	1
		S-80810	1.017	1.054	1.091	V	1
		S-80811	1.125	1.164	1.203	V	1
		S-80812	1.232	1.273	1.315	V	1
		S-80813	1.340	1.383	1.427	V	1
		S-80814	1.448	1.493	1.538	V	1
Hysteresis width	$V_{HYS}$	S-80808	0.018	0.034	0.051	V	1
		S-80809	0.028	0.044	0.061	V	1
		S-80810	0.037	0.054	0.071	V	1
		S-80811	0.047	0.064	0.081	V	1
		S-80812	0.056	0.073	0.091	V	1
		S-80813	0.066	0.083	0.101	V	1
		S-80814	0.076	0.093	0.110	V	1
Current consumption	$I_{SS}$	$V_{DD} = 1.5\text{ V}$   S-80808 to 09	—	1.3	3.5	$\mu\text{A}$	2
		$V_{DD} = 2.0\text{ V}$   S-80810 to 14	—	1.3	3.5	$\mu\text{A}$	2
Operating voltage	$V_{DD}$	—	0.65	—	5.0	V	1
Output current	$I_{OUT}$	Output transistor, Nch, $V_{DS} = 0.5\text{ V}$ , $V_{DD} = 0.7\text{ V}$	0.04	0.2	—	mA	3
Leakage current	$I_{LEAK}$	Output transistor, Nch, $V_{DS} = 5.0\text{ V}$ , $V_{DD} = 5.0\text{ V}$	—	—	60	nA	3
Response time	$t_{PLH}$	—	—	—	60	$\mu\text{s}$	1
Detection voltage temperature coefficient*2	$\frac{\Delta - V_{DET}}{\Delta Ta \bullet -V_{DET}}$	$Ta = -40\text{ to }+85\text{ }^\circ\text{C}$	—	$\pm 100$	$\pm 350$	ppm/ $^\circ\text{C}$	1

\*1.  $-V_{DET}$ : Actual detection voltage value,  $-V_{DET(S)}$ : Specified detection voltage value (The center value of the detection voltage range in **Table 1 to 2**.)

\*2. The temperature change of the detection voltage [mV/°C] is calculated by using the following equation.

$$\frac{\Delta - V_{DET}}{\Delta Ta} [\text{mV}/^\circ\text{C}]^{*1} = -V_{DET(S)} (\text{Typ.}) [\text{V}]^{*2} \times \frac{\Delta - V_{DET}}{\Delta Ta \bullet -V_{DET}} [\text{ppm}/^\circ\text{C}]^{*3} \div 1000$$

\*1. Temperature change of the detection voltage

\*2. Specified detection voltage

\*3. Detection voltage temperature coefficient

**1-2. Detection Voltage Typ.1.5 V or More Products**

**Table 15**

(Ta = 25 °C unless otherwise specified)

Item	Symbol	Condition	Min.	Typ.	Max.	Unit	Test circuit	
Detection voltage*1	$-V_{DET}$	—	$-V_{DET(S)} \times 0.98$	$-V_{DET(S)}$	$-V_{DET(S)} \times 1.02$	V	1	
Hysteresis width	$V_{HYS}$	—	$-V_{DET} \times 0.03$	$-V_{DET} \times 0.05$	$-V_{DET} \times 0.08$	V	1	
Current consumption	$I_{SS}$	$V_{DD} = 3.5\text{ V}$	S-80815 to 26	—	0.8	2.4	$\mu\text{A}$	2
		$V_{DD} = 4.5\text{ V}$	S-80827 to 39	—	0.8	2.4	$\mu\text{A}$	2
		$V_{DD} = 6.0\text{ V}$	S-80840 to 56	—	0.9	2.7	$\mu\text{A}$	2
		$V_{DD} = 7.5\text{ V}$	S-80857 to 60	—	0.9	2.7	$\mu\text{A}$	2
Operating voltage	$V_{DD}$	—	0.95	—	10.0	V	1	
Output current	$I_{OUT}$	Output transistor, $V_{DD} = 1.2\text{ V}$ Nch, $V_{DS} = 0.5\text{ V}$	S-80815 to 60	0.59	1.36	—	mA	3
			S-80827 to 60	2.88	4.98	—	mA	3
Leakage current	$I_{LEAK}$	Output transistor, Nch, $V_{DS} = 10.0\text{ V}$ , $V_{DD} = 10.0\text{ V}$	—	—	100	nA	3	
Response time	$t_{PLH}$	—	—	—	60	$\mu\text{s}$	1	
Detection voltage temperature coefficient*2	$\frac{\Delta - V_{DET}}{\Delta Ta \bullet -V_{DET}}$	Ta = -40 to +85 °C	—	$\pm 100$	$\pm 350$	ppm/°C	1	

\*1.  $-V_{DET}$ : Actual detection voltage value,  $-V_{DET(S)}$ : Specified detection voltage value (The center value of the detection voltage range in **Table 1 to 2**.)

\*2. The temperature change of the detection voltage [mV/°C] is calculated by using the following equation.

$$\frac{\Delta - V_{DET}}{\Delta Ta} [\text{mV}/^\circ\text{C}]^{*1} = -V_{DET(S)}(\text{Typ.})[\text{V}]^{*2} \times \frac{\Delta - V_{DET}}{\Delta Ta \bullet -V_{DET}} [\text{ppm}/^\circ\text{C}]^{*3} \div 1000$$

\*1. Temperature change of the detection voltage

\*2. Specified detection voltage

\*3. Detection voltage temperature coefficient

**SUPER-SMALL PACKAGE HIGH-PRECISION VOLTAGE DETECTOR**  
**S-808xxC Series**

Rev.6.1\_00

**2. CMOS Output Products**

**2-1. Detection Voltage Typ.1.4 V or Less Products**

**Table 16**

(Ta = 25 °C unless otherwise specified)

Item	Symbol	Condition	Min.	Typ.	Max.	Unit	Test circuit
Detection voltage*1	$-V_{DET}$	—	$-V_{DET(S)} \times 0.98$	$-V_{DET(S)}$	$-V_{DET(S)} \times 1.02$	V	1
Release voltage	$+V_{DET}$	S-80808	0.802	0.834	0.867	V	1
		S-80809	0.910	0.944	0.979	V	1
		S-80810	1.017	1.054	1.091	V	1
		S-80811	1.125	1.164	1.203	V	1
		S-80812	1.232	1.273	1.315	V	1
		S-80813	1.340	1.383	1.427	V	1
		S-80814	1.448	1.493	1.538	V	1
Hysteresis width	$V_{HYS}$	S-80808	0.018	0.034	0.051	V	1
		S-80809	0.028	0.044	0.061	V	1
		S-80810	0.037	0.054	0.071	V	1
		S-80811	0.047	0.064	0.081	V	1
		S-80812	0.056	0.073	0.091	V	1
		S-80813	0.066	0.083	0.101	V	1
		S-80814	0.076	0.093	0.110	V	1
Current consumption	$I_{SS}$	$V_{DD} = 1.5 V$ S-80808 to 09	—	1.3	3.5	$\mu A$	2
		$V_{DD} = 2.0 V$ S-80810 to 14	—	1.3	3.5	$\mu A$	2
Operating voltage	$V_{DD}$	—	0.65	—	5.0	V	1
Output current	$I_{OUT}$	Output transistor, Nch, $V_{DS} = 0.5 V$ , $V_{DD} = 0.7 V$	0.04	0.2	—	mA	3
		Output transistor, Pch, $V_{DS} = 2.1 V$ , $V_{DD} = 4.5 V$	2.9	5.8	—	mA	4
Response time	$t_{PLH}$	—	—	—	60	$\mu s$	1
Detection voltage temperature coefficient*2	$\frac{\Delta - V_{DET}}{\Delta Ta \bullet -V_{DET}}$	Ta = -40 to +85 °C	—	$\pm 100$	$\pm 350$	ppm/°C	1

\*1.  $-V_{DET}$ : Actual detection voltage value,  $-V_{DET(S)}$ : Specified detection voltage value (The center value of the detection voltage range in **Table 3 to 4**.)

\*2. The temperature change of the detection voltage [mV/°C] is calculated by using the following equation.

$$\frac{\Delta - V_{DET}}{\Delta Ta} [mV/°C]^*1 = -V_{DET(S)}(Typ.) [V]^*2 \times \frac{\Delta - V_{DET}}{\Delta Ta \bullet -V_{DET}} [ppm/°C]^*3 \div 1000$$

\*1. Temperature change of the detection voltage

\*2. Specified detection voltage

\*3. Detection voltage temperature coefficient

**2-2. Detection Voltage Typ.1.5 V or More Products**

**Table 17**

(Ta = 25 °C unless otherwise specified)

Item	Symbol	Condition	Min.	Typ.	Max.	Unit	Test circuit	
Detection voltage*1	$-V_{DET}$	—	$-V_{DET(S)} \times 0.98$	$-V_{DET(S)}$	$-V_{DET(S)} \times 1.02$	V	1	
Hysteresis width	$V_{HYS}$	—	$-V_{DET} \times 0.03$	$-V_{DET} \times 0.05$	$-V_{DET} \times 0.08$	V	1	
Current consumption	$I_{SS}$	$V_{DD} = 3.5\text{ V}$	S-80815 to 26	—	0.8	2.4	$\mu\text{A}$	2
		$V_{DD} = 4.5\text{ V}$	S-80827 to 39	—	0.8	2.4	$\mu\text{A}$	2
		$V_{DD} = 6.0\text{ V}$	S-80840 to 56	—	0.9	2.7	$\mu\text{A}$	2
		$V_{DD} = 7.5\text{ V}$	S-80857 to 60	—	0.9	2.7	$\mu\text{A}$	2
Operating voltage	$V_{DD}$	—	0.95	—	10.0	V	1	
Output current	$I_{OUT}$	Output transistor, Nch, $V_{DS} = 0.5\text{ V}$	$V_{DD} = 1.2\text{ V}$ S-80815 to 60	0.59	1.36	—	mA	3
			$V_{DD} = 2.4\text{ V}$ S-80827 to 60	2.88	4.98	—	mA	3
		Output transistor, Pch, $V_{DS} = 0.5\text{ V}$	$V_{DD} = 4.8\text{ V}$ S-80815 to 39	1.43	2.39	—	mA	4
			$V_{DD} = 6.0\text{ V}$ S-80840 to 56	1.68	2.78	—	mA	4
			$V_{DD} = 8.4\text{ V}$ S-80857 to 60	2.08	3.42	—	mA	4
Response time	$t_{PLH}$	—	—	—	60	$\mu\text{s}$	1	
Detection voltage temperature coefficient*2	$\frac{\Delta - V_{DET}}{\Delta T_a \bullet -V_{DET}}$	Ta = -40 to +85 °C	—	$\pm 100$	$\pm 350$	ppm/°C	1	

\*1.  $-V_{DET}$ : Actual detection voltage value,  $-V_{DET(S)}$ : Specified detection voltage value (The center value of the detection voltage range in **Table 3 to 4.**)

\*2. The temperature change of the detection voltage [mV/°C] is calculated by using the following equation.

$$\frac{\Delta - V_{DET}}{\Delta T_a} [\text{mV}/^\circ\text{C}]^{*1} = -V_{DET(S)} (\text{Typ.}) [\text{V}]^{*2} \times \frac{\Delta - V_{DET}}{\Delta T_a \bullet -V_{DET}} [\text{ppm}/^\circ\text{C}]^{*3} \div 1000$$

\*1. Temperature change of the detection voltage

\*2. Specified detection voltage

\*3. Detection voltage temperature coefficient

■ **Test Circuits**

1.



\*1. R is unnecessary for CMOS output products.

**Figure 11**

2.



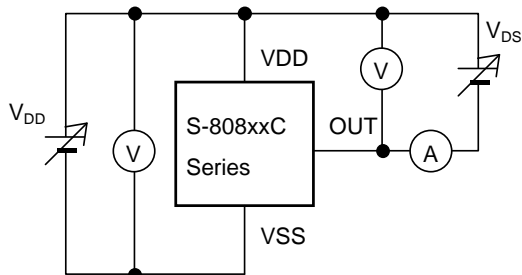
**Figure 12**

3.



**Figure 13**

4.



**Figure 14**

■ **Timing Chart**

**1. Nch Open-drain Output Products**



**Figure 15**

**2. CMOS Output Products**



**Figure 16**

**Remark** For values of  $V_{DD}$  less than minimum operating voltage, values of OUT terminal output is free in the shaded region.

■ **Operation**

**1. Basic Operation: CMOS Output (Active Low)**

**1-1.** When the power supply voltage ( $V_{DD}$ ) is higher than the release voltage ( $+V_{DET}$ ), the Nch transistor is OFF and the Pch transistor is ON to provide  $V_{DD}$  (high) at the output. Since the Nch transistor N1 in

**Figure 17** is OFF, the comparator input voltage is  $\frac{(R_B + R_C) \cdot V_{DD}}{R_A + R_B + R_C}$ .

**1-2.** When the  $V_{DD}$  goes below  $+V_{DET}$ , the output provides the  $V_{DD}$  level, as long as the  $V_{DD}$  remains above the detection voltage  $-V_{DET}$ . When the  $V_{DD}$  falls below  $-V_{DET}$  (point A in **Figure 18**), the Nch transistor becomes ON, the Pch transistor becomes OFF, and the  $V_{SS}$  level appears at the output. At this time the Nch transistor N1 in **Figure 17** becomes ON, the comparator input voltage is changed to

$$\frac{R_B \cdot V_{DD}}{R_A + R_B}$$

**1-3.** When the  $V_{DD}$  falls below the minimum operating voltage, the output becomes undefined, or goes to the  $V_{DD}$  when the output is pulled up to the  $V_{DD}$ .

**1-4.** The  $V_{SS}$  level appears when the  $V_{DD}$  rises above the minimum operating voltage. The  $V_{SS}$  level still appears even when the  $V_{DD}$  surpasses  $-V_{DET}$ , as long as it does not exceed the release voltage  $+V_{DET}$ .

**1-5.** When the  $V_{DD}$  rises above  $+V_{DET}$  (point B in **Figure 18**), the Nch transistor becomes OFF and the Pch transistor becomes ON to provide  $V_{DD}$  level at the output.



\*1. Parasitic diode

**Figure 17 Operation 1**



**Figure 18 Operation 2**

**2. Other Characteristics**

**2-1. Temperature Characteristics of Detection Voltage**

The shaded area in **Figure 19** shows the temperature characteristics of the detection voltage.



\*1.  $-V_{DET25}$  is an actual detection voltage value at 25°C.

**Figure 19 Temperature Characteristics of Detection Voltage (Example for S-80827C)**

**2-2. Temperature Characteristics of Release Voltage**

The temperature change  $\frac{\Delta + V_{DET}}{\Delta Ta}$  of the release voltage is calculated by using the temperature

change  $\frac{\Delta - V_{DET}}{\Delta Ta}$  of the detection voltage as follows:

$$\frac{\Delta + V_{DET}}{\Delta Ta} = \frac{+V_{DET}}{-V_{DET}} \times \frac{\Delta - V_{DET}}{\Delta Ta}$$

The temperature change of the release voltage and the detection voltage have the same sign consequently.



**2-3. Temperature Characteristics of Hysteresis Voltage**

The temperature change of the hysteresis voltage is expressed as  $\frac{\Delta + V_{DET}}{\Delta T_a} - \frac{\Delta - V_{DET}}{\Delta T_a}$  and is calculated

as follows:

$$\frac{\Delta + V_{DET}}{\Delta T_a} - \frac{\Delta - V_{DET}}{\Delta T_a} = \frac{V_{HYS}}{-V_{DET}} \times \frac{\Delta - V_{DET}}{\Delta T_a}$$

■ **Standard Circuit**



\*1. R is unnecessary for CMOS output products.

**Figure 20**

**Caution** The above connection diagram and constants do not guarantee correct operation. Perform sufficient evaluation using the actual application to set the constants.

■ **Technical Terms**

**1. Detection Voltage ( $-V_{DET}$ ), Release Voltage ( $+V_{DET}$ )**

The detection voltage ( $-V_{DET}$ ) is a voltage at which the output turns to low. The detection voltage varies slightly among products of the same specification. The variation of detection voltage between the specified minimum ( $-V_{DET}$ ) Min. and the maximum ( $-V_{DET}$ ) Max. is called the detection voltage range (Refer to **Figure 21**).

Example: For the S-80815CN, the detection voltage lies in the range of  $1.470 \leq (-V_{DET}) \leq 1.530$ .  
 This means that some S-80815CNs have 1.470 V for  $-V_{DET}$  and some have 1.530 V.

The release voltage ( $+V_{DET}$ ) is a voltage at which the output turns to high. The release voltage varies slightly among products of the same specification. The variation of release voltages between the specified minimum ( $+V_{DET}$ ) Min. and the maximum ( $+V_{DET}$ ) Max. is called the release voltage range (Refer to **Figure 22**). The range is calculated from the actual detection voltage ( $-V_{DET}$ ) of a product and is expressed by  $-V_{DET} \times 1.03 \leq +V_{DET} \leq -V_{DET} \times 1.08$ .

Example: For the S-80815CN, the release voltage lies in the range of  $1.514 \leq (+V_{DET}) \leq 1.652$ .  
 This means that some S-80815CNs have 1.514 V for  $+V_{DET}$  and some have 1.652 V.



**Figure 21 Detection Voltage (CMOS Output Products)**



**Figure 22 Release Voltage (CMOS Output Products)**

**Remark** Although the detection voltage and release voltage overlap in the range of 1.514 V to 1.530 V,  $+V_{DET}$  is always larger than  $-V_{DET}$ .

**2. Hysteresis Width ( $V_{HYS}$ )**

The hysteresis width is the voltage difference between the detection voltage and the release voltage (The voltage at point B – The voltage at point A =  $V_{HYS}$  in **Figure 18**). The existence of the hysteresis width prevents malfunction caused by noise on input signal.

**3. Through-type Current**

The through-type current refers to the current that flows instantaneously at the time of detection and release of a voltage detector. The through-type current is large in CMOS output products, small in Nch open-drain output products.

**4. Oscillation**

In applications where a resistor is connected to the voltage detector input (**Figure 23**), taking a CMOS active low product for example, the through-type current which is generated when the output goes from low to high (release) causes a voltage drop equal to [through-type current] × [input resistance] across the resistor. When the input voltage drops below the detection voltage ( $-V_{DET}$ ) as a result, the output voltage goes to low level. In this state, the through-type current stops and its resultant voltage drop disappears, and the output goes from low to high. A through-type current is again generated, a voltage drop appears, and repeating the process finally induces oscillation.



**Figure 23 An Example for Bad Implementation of Input Voltage Divider**

■ **Electrical Characteristics for Customized Products**

1. **S-80824KNUA-D2BT2x, S-80824KNY-n2-U**

**Table 18**

(Ta = 25 °C unless otherwise specified)

Item	Symbol	Condition	Min.	Typ.	Max.	Unit	Test circuit	
Detection voltage*1	$-V_{DET}$	—	2.295	2.400*2	2.505	V	1	
Release voltage	$+V_{DET}$	—	4.300	4.400	4.500	V	1	
Current consumption	$I_{SS}$	$V_{DD}=6.0\text{ V}$	—	0.8	2.4	$\mu\text{A}$	2	
Operating voltage	$V_{DD}$	—	0.95	—	10.0	V	1	
Output current	$I_{OUT}$	Output transistor, Nch, $V_{DS} = 0.5\text{ V}$	$V_{DD} = 0.95\text{ V}$	0.03	0.24	—	mA	3
			$V_{DD} = 1.2\text{ V}$	0.23	0.50	—	mA	3
Leakage current	$I_{LEAK}$	Output transistor, Nch, $V_{DD} = 10.0\text{ V}$ , $V_{DS} = 10.0\text{ V}$	—	—	0.1	$\mu\text{A}$	3	
Response time	$t_{PLH}$	—	—	—	60	$\mu\text{s}$	1	
Detection voltage temperature coefficient*3	$\frac{\Delta - V_{DET}}{\Delta Ta \bullet -V_{DET}}$	$Ta = -40\text{ to }85\text{ }^\circ\text{C}$	—	$\pm 100$	$\pm 350$	ppm/°C	1	

\*1.  $-V_{DET}$ : Actual detection voltage value

\*2. Specified detection voltage value ( $-V_{DET(S)}$ )

\*3. The temperature change of the detection voltage [mV/°C] is calculated by using the following equation.

$$\frac{\Delta - V_{DET}}{\Delta Ta} [\text{mV}/^\circ\text{C}]^*1 = -V_{DET(S)}(\text{Typ.})[\text{V}]^*2 \times \frac{\Delta - V_{DET}}{\Delta Ta \bullet -V_{DET}} [\text{ppm}/^\circ\text{C}]^*3 \div 1000$$

\*1. Temperature change of the detection voltage

\*2. Specified detection voltage

\*3. Detection voltage temperature coefficient

**2. S-80844KLUA-D2AT2x, S-80844KLY-n2-U**

**Table 19**

(Ta = 25 °C unless otherwise specified)

Item	Symbol	Condition	Min.	Typ.	Max.	Unit	Test circuit	
Detection voltage <sup>*1</sup>	-V <sub>DET</sub>	—	4.295	4.450 <sup>*2</sup>	4.605	V	1	
Release voltage	+V <sub>DET</sub>	—	—	—	4.700	V	1	
Current consumption	I <sub>SS</sub>	V <sub>DD</sub> = 6.0 V	—	1.0	3.0	μA	2	
Operating voltage	V <sub>DD</sub>	—	0.95	—	10.0	V	1	
Output current	I <sub>OUT</sub>	Output transistor, Nch, V <sub>DS</sub> = 0.5 V	V <sub>DD</sub> = 1.2 V	0.23	0.50	—	mA	3
			V <sub>DD</sub> = 2.4 V	1.60	3.70	—	mA	3
		Output transistor, Pch, V <sub>DS</sub> = 0.5 V	V <sub>DD</sub> = 4.8 V	0.36	0.62	—	mA	4
Response time	t <sub>PLH</sub>	—	—	—	60	μs	1	
Detection voltage temperature coefficient <sup>*3</sup>	$\frac{\Delta - V_{DET}}{\Delta Ta \bullet -V_{DET}}$	Ta = -40 to 85 °C	—	±100	±350	ppm/°C	1	

\*1. -V<sub>DET</sub>: Actual detection voltage value

\*2. Specified detection voltage value (-V<sub>DET(S)</sub>)

\*3. The temperature change of the detection voltage [mV/°C] is calculated by using the following equation.

$$\frac{\Delta - V_{DET}}{\Delta Ta} [\text{mV}/^\circ\text{C}]^{*1} = -V_{DET(S)}(\text{Typ.})[\text{V}]^{*2} \times \frac{\Delta - V_{DET}}{\Delta Ta \bullet -V_{DET}} [\text{ppm}/^\circ\text{C}]^{*3} \div 1000$$

\*1. Temperature change of the detection voltage

\*2. Specified detection voltage

\*3. Detection voltage temperature coefficient

**3. S-80846KNUA-D2CT2x, S-80846KNY-n2-U**

**Table 20**

(Ta = 25 °C unless otherwise specified)

Item	Symbol	Condition	Min.	Typ.	Max.	Unit	Test circuit
Detection voltage <sup>*1</sup>	$-V_{DET}$	—	4.500	4.600 <sup>*2</sup>	4.700	V	1
Hysteresis width	$V_{HYS}$	—	—	0.05	0.10	V	1
Current consumption	$I_{SS}$	$V_{DD} = 6.0\text{ V}$	—	0.9	2.7	$\mu\text{A}$	2
Operating voltage	$V_{DD}$	—	0.95	—	10.0	V	1
Output current	$I_{OUT}$	Output transistor, $V_{DD} = 1.2\text{ V}$ Nch, $V_{DS} = 0.5\text{ V}$	0.59	1.36	—	mA	3
		$V_{DD} = 2.4\text{ V}$	2.88	4.98	—	mA	3
Leakage current	$I_{LEAK}$	Output transistor, Nch, $V_{DD} = 10.0\text{ V}$ , $V_{DS} = 10.0\text{ V}$	—	—	0.1	$\mu\text{A}$	3
Response time	$t_{PLH}$	—	—	—	60	$\mu\text{s}$	1
Detection voltage temperature coefficient <sup>*3</sup>	$\frac{\Delta - V_{DET}}{\Delta T_a \bullet -V_{DET}}$	$T_a = -40\text{ to }85\text{ }^\circ\text{C}$	—	$\pm 100$	$\pm 350$	ppm/ $^\circ\text{C}$	1

\*1.  $-V_{DET}$ : Actual detection voltage value

\*2. Specified detection voltage value ( $-V_{DET(S)}$ )

\*3. The temperature change of the detection voltage [mV/ $^\circ\text{C}$ ] is calculated by using the following equation.

$$\frac{\Delta - V_{DET}}{\Delta T_a} [\text{mV}/^\circ\text{C}]^{*1} = -V_{DET(S)}(\text{Typ.})[\text{V}]^{*2} \times \frac{\Delta - V_{DET}}{\Delta T_a \bullet -V_{DET}} [\text{ppm}/^\circ\text{C}]^{*3} \div 1000$$

\*1. Temperature change of the detection voltage

\*2. Specified detection voltage

\*3. Detection voltage temperature coefficient

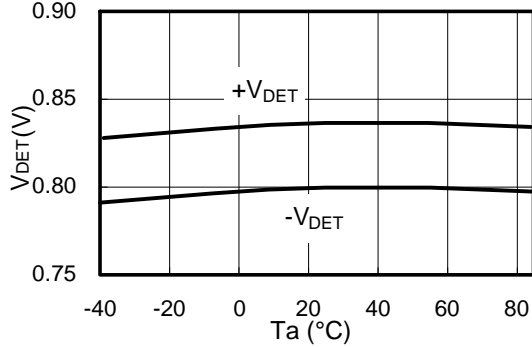
**■ Precautions**

- Do not apply an electrostatic discharge to this IC that exceeds the performance ratings of the built-in electrostatic protection circuit.
- In CMOS output products of the S-808xxC series, the through-type current flows at the detection and the release. If the input impedance is high, oscillation may occur due to the voltage drop by the through-type current during releasing.
- In CMOS output products oscillation may occur when a pull-down resistor is used, and falling speed of the power supply voltage ( $V_{DD}$ ) is slow near the detection voltage.
- When designing for mass production using an application circuit described herein, the product deviation and temperature characteristics should be taken into consideration. SII shall not bear any responsibility for the products on the circuits described herein.
- SII claims no responsibility for any and all disputes arising out of or in connection with any infringement of the products including this IC upon patents owned by a third party.

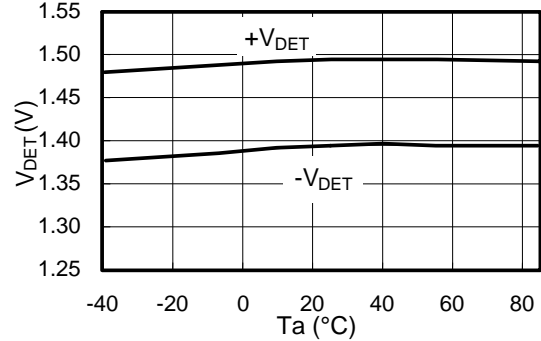
■ **Typical Characteristics (Typical Data)**

**1. Detection Voltage ( $V_{DET}$ ) - Temperature ( $T_a$ )**

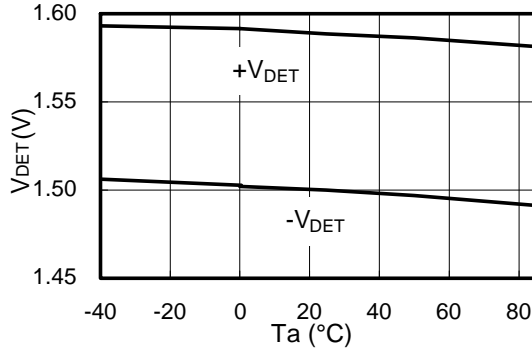
S-80808CL



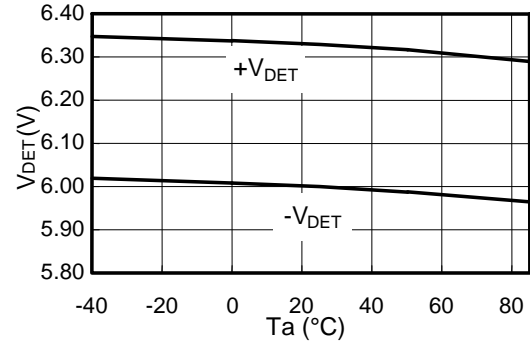
S-80814CL



S-80815CL

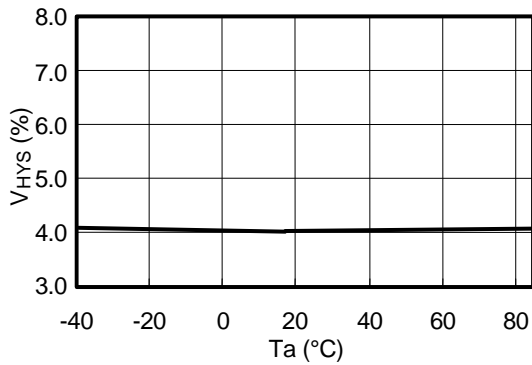


S-80860CL

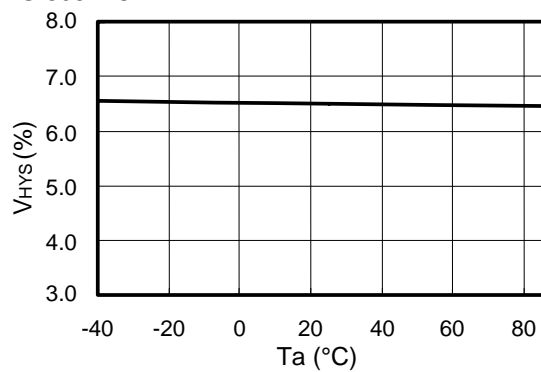


**2. Hysteresis Voltage Width ( $V_{HYS}$ ) - Temperature ( $T_a$ )**

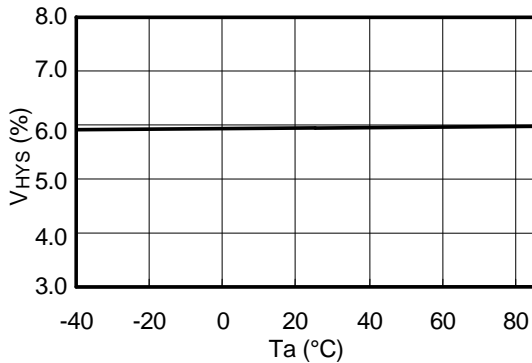
S-80808CL



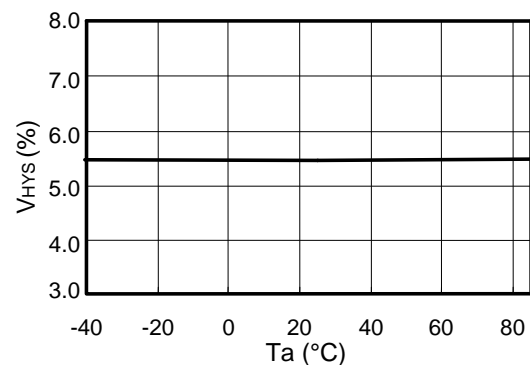
S-80814CL



S-80815CL



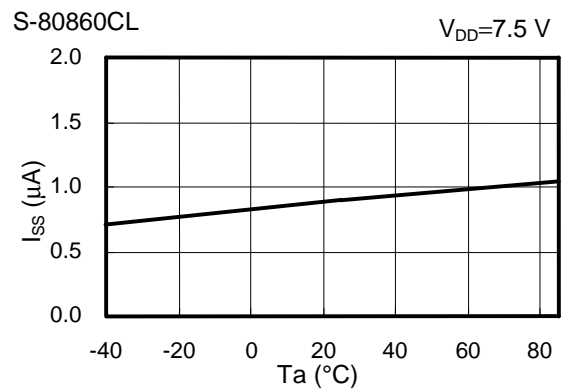
S-80860CL



**3. Current Consumption ( $I_{SS}$ ) - Input Voltage ( $V_{DD}$ )**



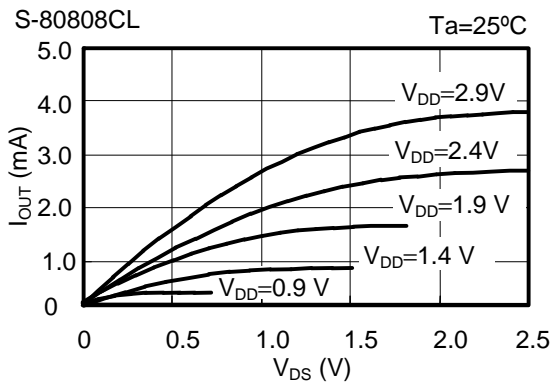
**4. Current Consumption ( $I_{SS}$ ) - Temperature ( $T_a$ )**



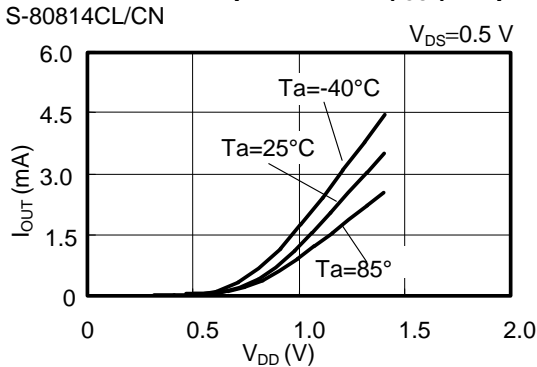
**5. Nch Transistor Output Current ( $I_{OUT}$ ) -  $V_{DS}$**



**6. Pch Transistor Output Current ( $I_{OUT}$ ) -  $V_{DS}$**



**7. Nch Transistor Output Current ( $I_{OUT}$ ) - Input Voltage ( $V_{DD}$ )**



**8. Pch Transistor Output Current ( $I_{OUT}$ ) - Input Voltage ( $V_{DD}$ )**



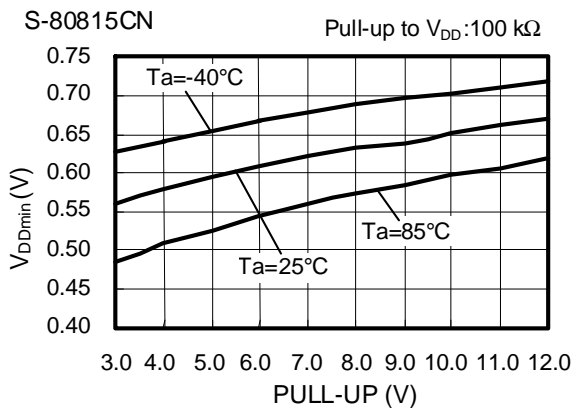


**9. Minimum Operating Voltage - Input Voltage ( $V_{DD}$ )**



**Remark**  $V_{DDmin}$  is defined by the  $V_{DD}$  voltage at which  $V_{OUT}$  goes below 10% of PULL-UP voltage when the  $V_{DD}$  increase from 0 V.

**Figure 24**



**10. Dynamic Response - C<sub>OUT</sub>**





**Figure 25 Measurement Condition for Response Time**



**\*1. R is unnecessary for CMOS output products.**

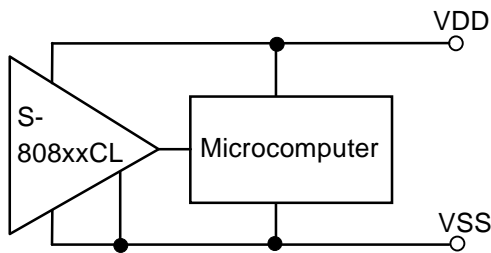
**Figure 26 Measurement Circuit for Response Time**

**Caution** The above connection diagram and constants do not guarantee correct operation. Perform sufficient evaluation using the actual application to set the constants.

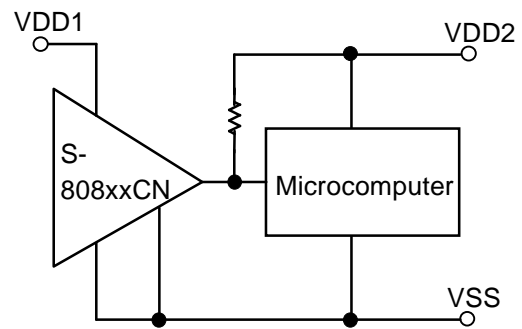
■ **Application Circuit Examples**

**1. Microcomputer Reset Circuits**

If the power supply voltage to a microcomputer falls below the specified level, an unspecified operation may be performed or the contents of the memory register may be lost. When power supply voltage returns to normal, the microcomputer needs to be initialized before normal operations can be done. Reset circuits protect microcomputers in the event of current being momentarily switched off or lowered. Reset circuits shown in **Figures 27 to 28** can be easily constructed with the help of the S-808xxC series, that has low operating voltage, a high-precision detection voltage and hysteresis.



**Figure 27 Reset Circuit Example(S-808xxCL)**



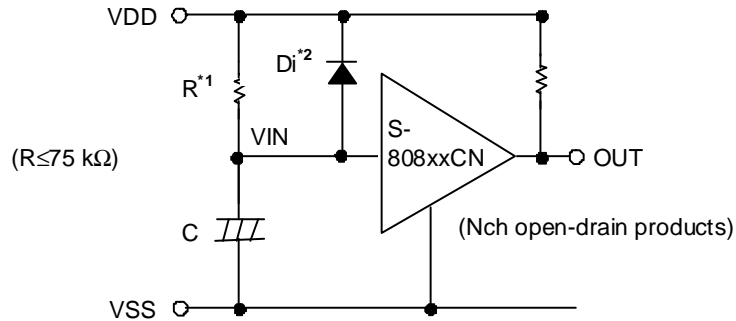
(Only for Nch open-drain products)

**Figure 28 Reset Circuit Example (S-808xxCN)**

**Caution** The above connection diagram and constants do not guarantee correct operation. Perform sufficient evaluation using the actual application to set the constants.

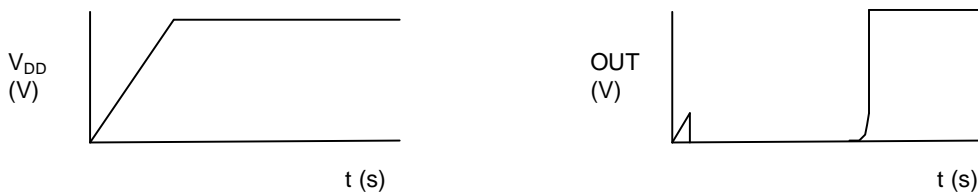
**2. Power-on Reset Circuit**

A power-on reset circuit can be constructed using Nch open-drain output product of S-808xxC Series.



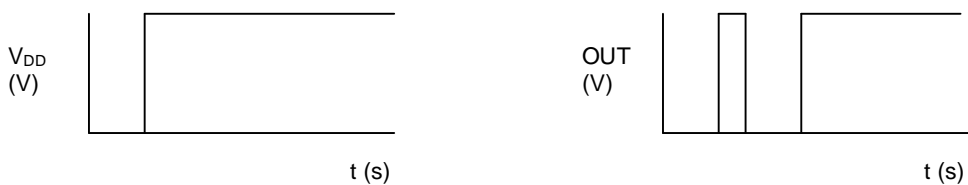
- \*1. Resistor R should be 75 kΩ or less to prevent oscillation.
- \*2. Diode Di instantaneously discharges the charge stored in the capacitor (C) at the power falling, Di can be removed when the delay of the falling time is not important.

**Figure 29**



**Figure 30**

**Remark** When the power rises sharply as shown in the **Figure 31** left, the output may goes to the high level for an instant in the undefined region where the output voltage is undefined since the power voltage is less than the minimum operation voltage.



**Figure 31**

**3. Change of Detection Voltage**

In Nch open-drain output products of the S-808xxC series, detection voltage can be changed using resistance dividers or diodes as shown in **Figures 32 to 33**. In **Figure 32**, hysteresis width also changes.



$$\text{Detection voltage} = \frac{R_A + R_B}{R_B} \cdot -V_{DET}$$

$$\text{Hysteresis width} = \frac{R_A + R_B}{R_B} \cdot V_{HYS}$$



$$\text{Detection voltage} = V_{f1} + V_{f2} + (-V_{DET})$$

\*1.  $R_A$  should be 75 kΩ or less to prevent oscillation.

**Caution** If  $R_A$  and  $R_B$  are large, the hysteresis width may also be larger than the value given by the above equation due to the through-type current (which flows slightly in an Nch open-drain product).

Figure 32

Figure 33

**Caution** The above connection diagram and constants do not guarantee correct operation. Perform sufficient evaluation using the actual application to set the constants.



No. NP004-A-P-SD-1.1

TITLE	SC82AB-A-PKG Dimensions
No.	NP004-A-P-SD-1.1
SCALE	
UNIT	mm

Seiko Instruments Inc.



No. NP004-A-C-SD-3.0

TITLE	SC82AB-A-Carrier Tape
No.	NP004-A-C-SD-3.0
SCALE	
UNIT	mm
Seiko Instruments Inc.	



→  
Feed direction

No. NP004-A-C-S1-2.0

TITLE	SC82AB-A-Carrier Tape
No.	NP004-A-C-S1-2.0
SCALE	
UNIT	mm

Seiko Instruments Inc.





Enlarged drawing in the central part



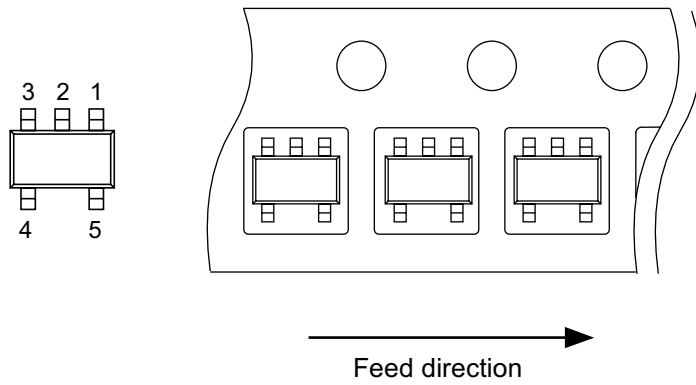
No. NP004-A-R-SD-1.1

TITLE	SC82AB-A-Reel		
No.	NP004-A-R-SD-1.1		
SCALE		QTY.	3,000
UNIT	mm		
Seiko Instruments Inc.			



No. MP005-A-P-SD-1.2

TITLE	SOT235-A-PKG Dimensions
No.	MP005-A-P-SD-1.2
SCALE	
UNIT	mm
Seiko Instruments Inc.	



No. MP005-A-C-SD-2.1

TITLE	SOT235-A-Carrier Tape
No.	MP005-A-C-SD-2.1
SCALE	
UNIT	mm
Seiko Instruments Inc.	

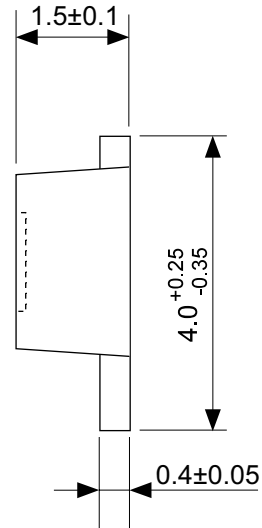


Enlarged drawing in the central part



No. MP005-A-R-SD-1.1

TITLE	SOT235-A-Reel		
No.	MP005-A-R-SD-1.1		
SCALE		QTY.	3,000
UNIT	mm		
Seiko Instruments Inc.			



No. UP003-A-P-SD-1.1

TITLE	SOT893-A-PKG Dimensions
No.	UP003-A-P-SD-1.1
SCALE	
UNIT	mm
Seiko Instruments Inc.	



→  
Feed direction

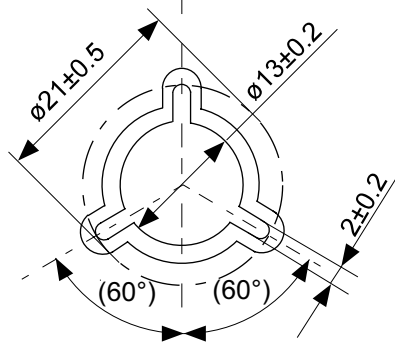
No. UP003-A-C-SD-1.1

TITLE	SOT893-A-Carrier Tape
No.	UP003-A-C-SD-1.1
SCALE	
UNIT	mm

Seiko Instruments Inc.



Enlarged drawing in the central part



No. UP003-A-R-SD-1.1

TITLE	SOT893-A-Reel		
No.	UP003-A-R-SD-1.1		
SCALE		QTY.	1,000
UNIT	mm		

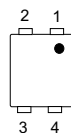
Seiko Instruments Inc.



No. PF004-A-P-SD-4.0

TITLE	SNT-4A-A-PKG Dimensions
No.	PF004-A-P-SD-4.0
SCALE	
UNIT	mm
Seiko Instruments Inc.	





Feed direction →

No. PF004-A-C-SD-1.0

TITLE	SNT-4A-A-Carrier Tape
No.	PF004-A-C-SD-1.0
SCALE	
UNIT	mm
Seiko Instruments Inc.	



Enlarged drawing in the central part



No. PF004-A-R-SD-1.0

TITLE	SNT-4A-A-Reel		
No.	PF004-A-R-SD-1.0		
SCALE		QTY.	5,000
UNIT	mm		
Seiko Instruments Inc.			



※1. ランドパターンの幅に注意してください (0.25 mm min. / 0.30 mm typ.).

※2. パッケージ中央にランドパターンを広げないでください (1.10 mm ~ 1.20 mm)。

- 注意
1. パッケージのモールド樹脂下にシルク印刷やハンダ印刷などしないでください。
  2. パッケージ下の配線上のソルダーレジストなどの厚みをランドパターン表面から0.03 mm以下にしてください。
  3. マスク開口サイズと開口位置はランドパターンと合わせてください。
  4. 詳細は "SNTパッケージ活用の手引き" を参照してください。

※1. Pay attention to the land pattern width (0.25 mm min. / 0.30 mm typ.).

※2. Do not widen the land pattern to the center of the package (1.10 mm to 1.20 mm).

- Caution**
1. Do not do silkscreen printing and solder printing under the mold resin of the package.
  2. The thickness of the solder resist on the wire pattern under the package should be 0.03 mm or less from the land pattern surface.
  3. Match the mask aperture size and aperture position with the land pattern.
  4. Refer to "SNT Package User's Guide" for details.

※1. 请注意焊盘模式的宽度 (0.25 mm min. / 0.30 mm typ.).

※2. 请勿向封装中间扩展焊盘模式 (1.10 mm ~ 1.20 mm)。

- 注意
1. 请勿在树脂型封装的下面印刷丝网、焊锡。
  2. 在封装下、布线上的阻焊膜厚度 (从焊盘模式表面起) 请控制在0.03 mm以下。
  3. 掩膜的开口尺寸和开口位置请与焊盘模式对齐。
  4. 详细内容请参阅 "SNT封装的应用指南"。

No. PF004-A-L-SD-4.0

TITLE	SNT-4A-A-Land Recommendation
No.	PF004-A-L-SD-4.0
SCALE	
UNIT	mm
Seiko Instruments Inc.	



No. YS003-D-P-SD-2.0

TITLE	TO92-D-PKG Dimensions
No.	YS003-D-P-SD-2.0
SCALE	
UNIT	mm

Seiko Instruments Inc.

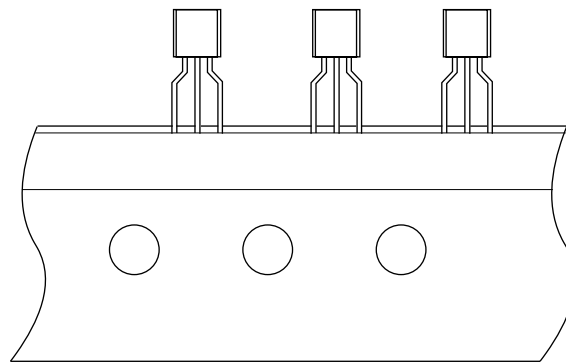


No. YZ003-E-P-SD-2.0

TITLE	TO92-E-PKG Dimensions
No.	YZ003-E-P-SD-2.0
SCALE	
UNIT	mm
Seiko Instruments Inc.	



Z type



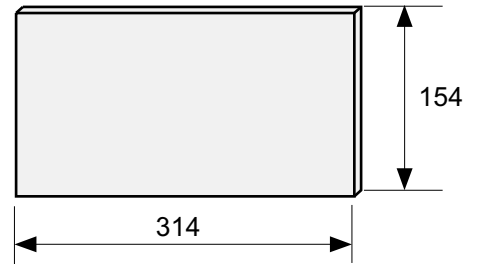
→  
Feed direction

No. YZ003-E-C-SD-1.1

TITLE	TO92-E-Radial Tape
No.	YZ003-E-C-SD-1.1
SCALE	
UNIT	mm
Seiko Instruments Inc.	



Side spacer placed in front side



Space more than 4 strokes



No. YZ003-E-Z-SD-2.0

TITLE	TO92-E-Ammo Packing		
No.	YZ003-E-Z-SD-2.0		
SCALE		QTY.	2,000
UNIT	mm		
Seiko Instruments Inc.			



Seiko Instruments Inc.  
[www.sii-ic.com](http://www.sii-ic.com)

- The information described herein is subject to change without notice.
- Seiko Instruments Inc. is not responsible for any problems caused by circuits or diagrams described herein whose related industrial properties, patents, or other rights belong to third parties. The application circuit examples explain typical applications of the products, and do not guarantee the success of any specific mass-production design.
- When the products described herein are regulated products subject to the Wassenaar Arrangement or other agreements, they may not be exported without authorization from the appropriate governmental authority.
- Use of the information described herein for other purposes and/or reproduction or copying without the express permission of Seiko Instruments Inc. is strictly prohibited.
- The products described herein cannot be used as part of any device or equipment affecting the human body, such as exercise equipment, medical equipment, security systems, gas equipment, vehicle equipment, in-vehicle equipment, aviation equipment, aerospace equipment, and nuclear-related equipment, without prior written permission of Seiko Instruments Inc.
- The products described herein are not designed to be radiation-proof.
- Although Seiko Instruments Inc. exerts the greatest possible effort to ensure high quality and reliability, the failure or malfunction of semiconductor products may occur. The user of these products should therefore give thorough consideration to safety design, including redundancy, fire-prevention measures, and malfunction prevention, to prevent any accidents, fires, or community damage that may ensue.



Компания «Океан Электроники» предлагает заключение долгосрочных отношений при поставках импортных электронных компонентов на взаимовыгодных условиях!

Наши преимущества:

- Поставка оригинальных импортных электронных компонентов напрямую с производств Америки, Европы и Азии, а так же с крупнейших складов мира;
- Широкая линейка поставок активных и пассивных импортных электронных компонентов (более 30 млн. наименований);
- Поставка сложных, дефицитных, либо снятых с производства позиций;
- Оперативные сроки поставки под заказ (от 5 рабочих дней);
- Экспресс доставка в любую точку России;
- Помощь Конструкторского Отдела и консультации квалифицированных инженеров;
- Техническая поддержка проекта, помощь в подборе аналогов, поставка прототипов;
- Поставка электронных компонентов под контролем ВП;
- Система менеджмента качества сертифицирована по Международному стандарту ISO 9001;
- При необходимости вся продукция военного и аэрокосмического назначения проходит испытания и сертификацию в лаборатории (по согласованию с заказчиком);
- Поставка специализированных компонентов военного и аэрокосмического уровня качества (Xilinx, Altera, Analog Devices, Intersil, Interpoint, Microsemi, Actel, Aeroflex, Peregrine, VPT, Syfer, Eurofarad, Texas Instruments, MS Kennedy, Miteq, Cobham, E2V, MA-COM, Hittite, Mini-Circuits, General Dynamics и др.);

Компания «Океан Электроники» является официальным дистрибьютором и эксклюзивным представителем в России одного из крупнейших производителей разъемов военного и аэрокосмического назначения «JONHON», а так же официальным дистрибьютором и эксклюзивным представителем в России производителя высокотехнологичных и надежных решений для передачи СВЧ сигналов «FORSTAR».



## JONHON

«JONHON» (основан в 1970 г.)

Разъемы специального, военного и аэрокосмического назначения:

(Применяются в военной, авиационной, аэрокосмической, морской, железнодорожной, горно- и нефтедобывающей отраслях промышленности)

«FORSTAR» (основан в 1998 г.)

ВЧ соединители, коаксиальные кабели,  
кабельные сборки и микроволновые компоненты:

(Применяются в телекоммуникациях гражданского и специального назначения, в средствах связи, РЛС, а так же военной, авиационной и аэрокосмической отраслях промышленности).



Телефон: 8 (812) 309-75-97 (многоканальный)

Факс: 8 (812) 320-03-32

Электронная почта: [ocean@oceanchips.ru](mailto:ocean@oceanchips.ru)

Web: <http://oceanchips.ru/>

Адрес: 198099, г. Санкт-Петербург, ул. Калинина, д. 2, корп. 4, лит. А