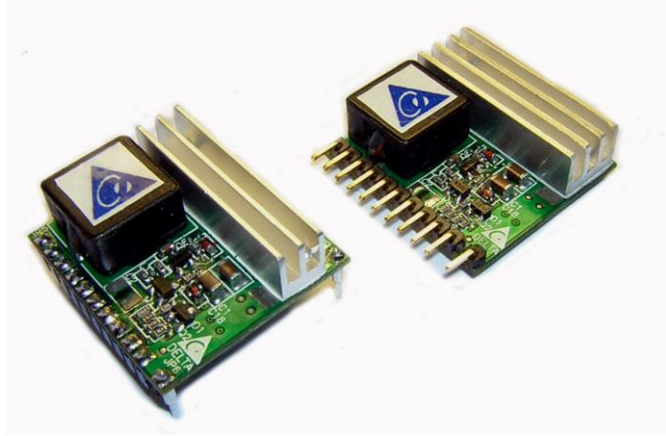


# DELPHI SERIES



## Delphi NC15 Series Non-Isolated Point of Load DC/DC Power Modules: 12Vin, 0.9V-5.0Vout, 15A

The Delphi NC15 Series, 12V input, single output, non-isolated point of load DC/DC converters are the latest offering from a world leader in power systems technology and manufacturing — Delta Electronics, Inc. The NC15 series operates from a 12V nominal input, provides up to 15A of power in a vertical or horizontal mounted through-hole package and the output can be resistor- or voltage-trimmed from 0.9Vdc to 5.0Vdc. It provides a very cost effective point of load solution. With creative design technology and optimization of component placement, these converters possess outstanding electrical and thermal performance, as well as extremely high reliability under highly stressful operating conditions.

### FEATURES

- ♦ High Efficiency:  
91% @ 12Vin, 5V/15A out
- ♦ Size: 30.5x27.9x11.4mm  
(1.20"×1.10"×0.45") -- Vertical  
30.5x27.9x12.9mm  
(1.20"×1.10"×0.51") -- Horizontal
- ♦ Voltage and resistor-based trim
- ♦ No minimum load required
- ♦ Output voltage programmable from 0.9Vdc to 5.0Vdc via external resistors
- ♦ Fixed frequency operation
- ♦ Input UVLO, output OCP, SCP
- ♦ Power good output signal
- ♦ Remote ON/OFF (default: Positive)
- ♦ ISO 9000, TL 9000, ISO 14001 certified manufacturing facility
- ♦ UL/cUL 60950-1 (US & Canada) Recognized, and TUV (EN60950-1) Certified
- ♦ CE mark meets 73/23/EEC and 93/68/EEC directives

### OPTIONS

- ♦ Vertical or horizontal versions
- ♦ Negative ON/OFF logic

### APPLICATIONS

- ♦ DataCom
- ♦ Distributed power architectures
- ♦ Servers and workstations
- ♦ LAN / WAN applications
- ♦ Data processing applications

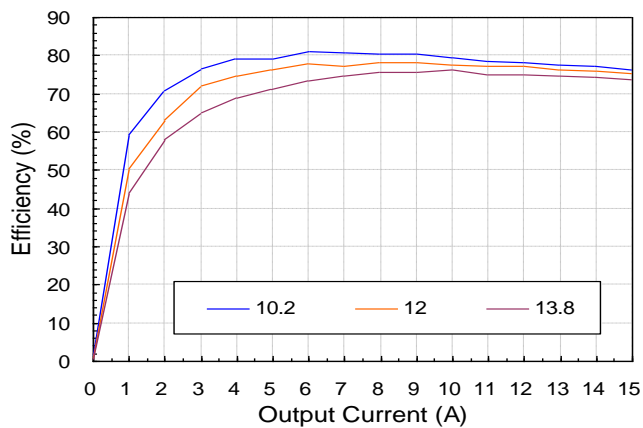
# TECHNICAL SPECIFICATIONS

(Ambient Temperature=25°C, minimum airflow=200LFM, nominal  $V_{in}=12V_{dc}$  unless otherwise specified.)

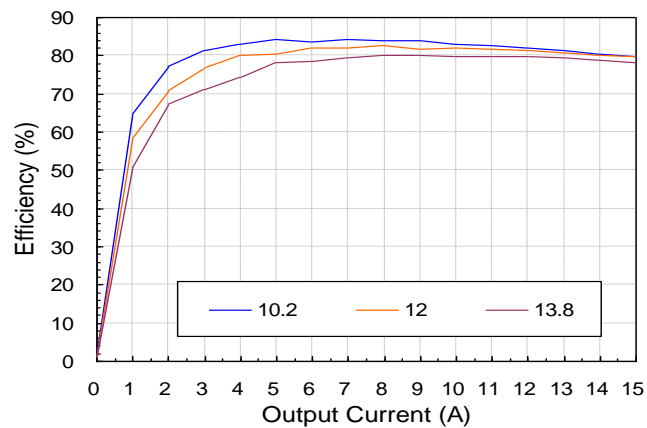
PARAMETER	NOTES and CONDITIONS	NC12S0A0V/H15			
		Min.	Typ.	Max.	Units
<b>ABSOLUTE MAXIMUM RATINGS</b>					
Input Voltage				14	Vdc
Operating Temperature (Vertical)	With appropriate air flow and derating, see Figs 33	0		130	°C
Operating Temperature (Horizontal)	With appropriate air flow and derating, see Figs 39	-40		125	°C
Storage Temperature		-40		125	°C
Input/Output Isolation Voltage	Non-isolated		NA		V
<b>INPUT CHARACTERISTICS</b>					
Operating Input Voltage		10.2	12.0	13.8	V
Input Under-Voltage Lockout					
Turn-On Voltage Threshold			9.0		V
Turn-Off Voltage Threshold			7.5		V
Lockout Hysteresis Voltage			1.5		V
Maximum Input Current	100% Load, 10.2Vin, 5.0Vout			8.1	A
No-Load Input Current	Vin=12V, Vout=0.9V		65		mA
Off Converter Input Current	Remote OFF		9		mA
Input Reflected-Ripple Current	Refer to Figure 31.		150		mA
Input Ripple Rejection	120Hz		45		dB
<b>OUTPUT CHARACTERISTICS</b>					
Output Voltage Adjustment Range		0.9		5.0	V
Output Voltage Set Point	With a 1.0% trim resistor	-2.5		+2.5	%
Output Voltage Regulation					
Over Load	Io=Io_min to Io_max	-1.0		+1.0	%
Over Line	Vin=Vin_min to Vin_max	-0.2		+0.2	%
Output Voltage Ripple and Noise	5Hz to 20MHz bandwidth				
Peak-to-Peak	Full Load, 100nF ceramic, 10µF tantalum			50	mV
RMS	Full Load, 100nF ceramic, 10µF tantalum			20	mV
Output Current Range		0		15	A
Output Voltage Over-shoot at Start-up	Vin=12V, Turn ON			1	%
Output Voltage Under-shoot at Power-Off	Vin=12V, Turn OFF			100	mV
Output DC Current-Limit Inception	Hiccup mode	16			A
Output Short-Circuit Current	Hiccup mode				
<b>DYNAMIC CHARACTERISTICS</b>					
Output Dynamic Load Response	12Vin, 100nF ceramic, 10µF tantalum load cap, 10A/µs				
Positive Step Change in Output Current	50% Io_max to 75% Io_max			100	mV
Negative Step Change in Output Current	75% Io_max to 50% Io_max			100	mV
Settling Time	Settling to be within regulation band (Vo +/- 2.5%)			200	µs
Turn-On Transient					
Start-Up Time, from On/Off Control	From Enable high to 10% of Vo			10	ms
Start-Up Time, from input power	From Vin=12V to 10% of Vo			10	ms
Minimum Output Capacitance	Ex: OSCON 6.3V/680µF (ESR 13 mΩ max.)	680			µF
Maximum Output Startup Capacitive Load	Full Load			6800	µF
Minimum Input Capacitance	Ex: OSCON 16V/270µF (ESR 18 mΩ max.)	270			µF
<b>EFFICIENCY</b>					
Vo=0.9V	Vin=12V, Io=15A		75		%
Vo=1.2V	Vin=12V, Io=15A		79		%
Vo=1.5V	Vin=12V, Io=15A		81		%
Vo=1.8V	Vin=12V, Io=15A		84		%
Vo=2.5V	Vin=12V, Io=15A		87		%
Vo=3.3V	Vin=12V, Io=15A		89		%
Vo=5.0V	Vin=12V, Io=15A		91		%
<b>FEATURE CHARACTERISTICS</b>					
Switching Frequency	fixed		300		KHz
ON/OFF Control	Positive logic (internally pulled high)				
Logic High	Module On (or leave the pin open)	2.4		5.5	V
Logic Low	Module Off	0		0.8	V
<b>GENERAL SPECIFICATIONS</b>					
MTBF	Telcordia SR-332 Issue1 Method1 Case3 at 50°C		2.1		M hours
Weight			16.5		grams



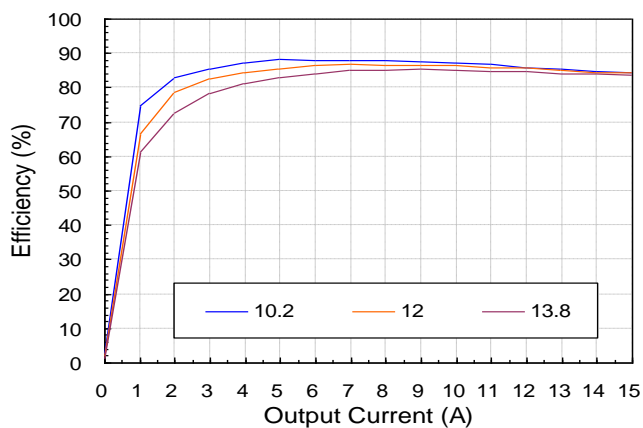
# ELECTRICAL CHARACTERISTICS CURVES



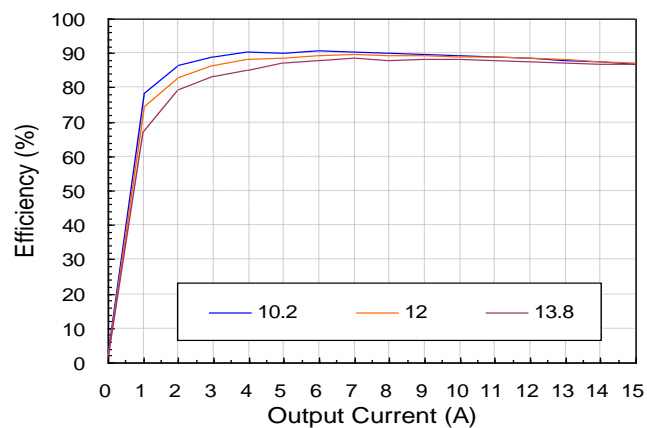
**Figure 1:** Converter efficiency vs. output current (0.9V output voltage)



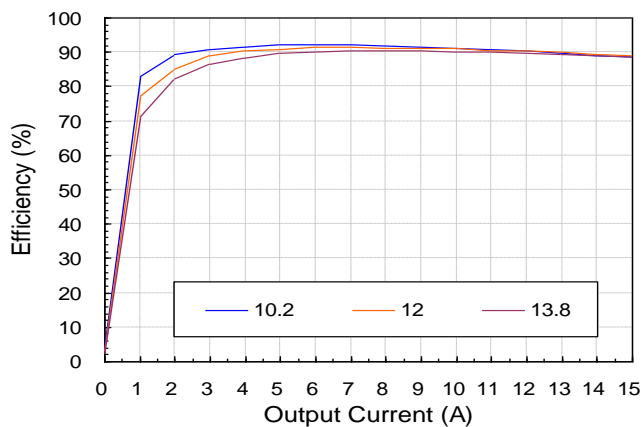
**Figure 2:** Converter efficiency vs. output current (1.2V output voltage)



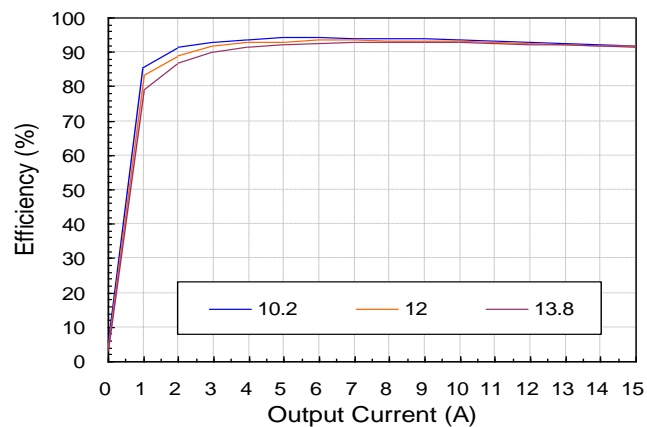
**Figure 3:** Converter efficiency vs. output current (1.8V output voltage)



**Figure 4:** Converter efficiency vs. output current (2.5V output voltage)



**Figure 5:** Converter efficiency vs. output current (3.3V output voltage)



**Figure 6:** Converter efficiency vs. output current (5.0V output voltage)



# ELECTRICAL CHARACTERISTICS CURVES

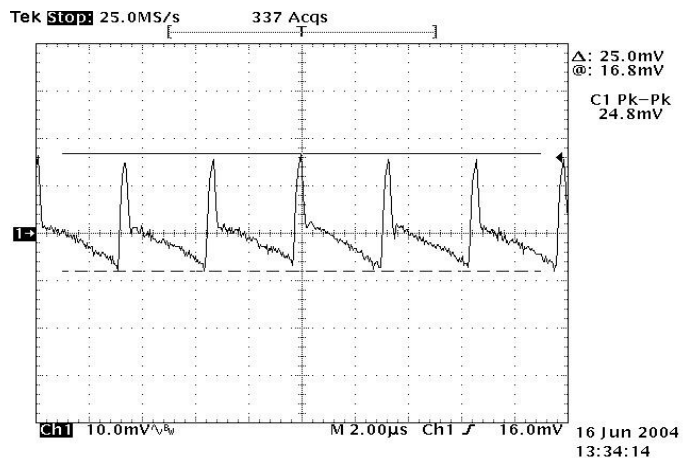


Figure 7: Output ripple & noise at 12Vin, 0.9V/15A out

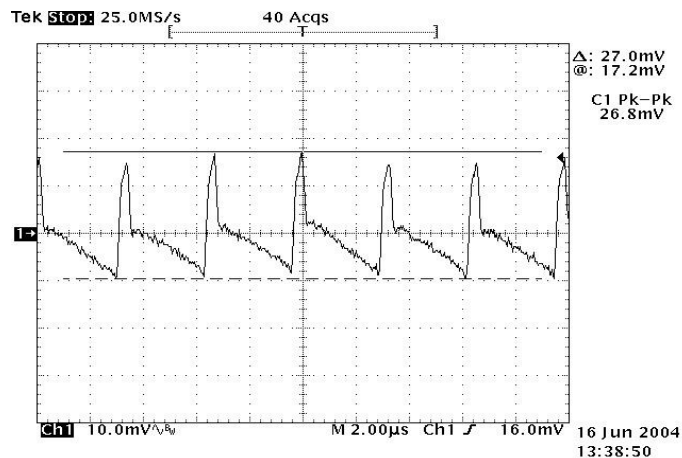


Figure 8: Output ripple & noise at 12Vin, 1.2V/15A out

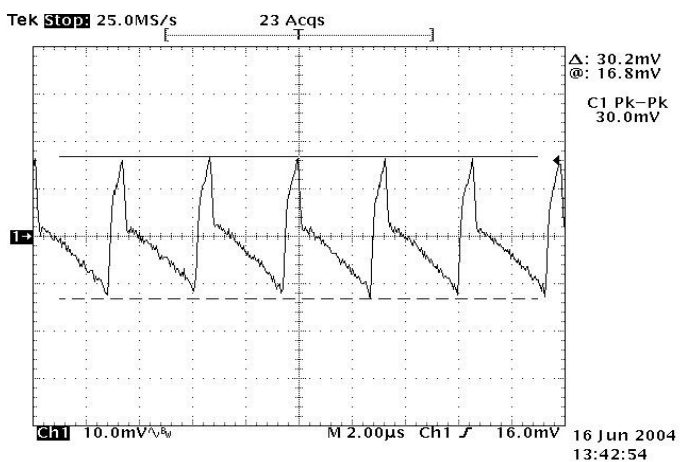


Figure 9: Output ripple & noise at 12Vin, 1.8V/15A out

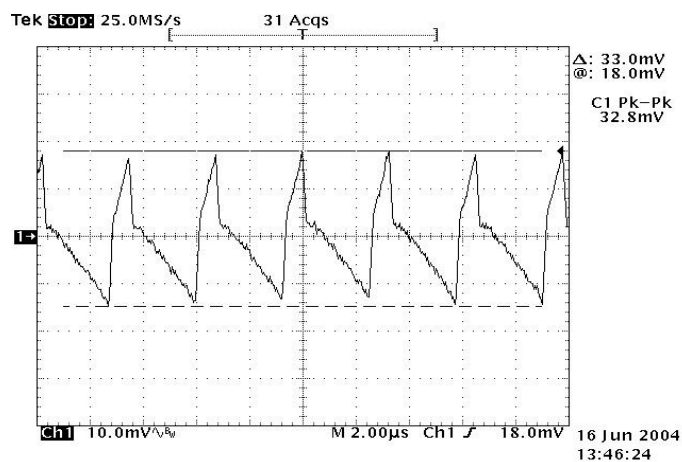


Figure 10: Output ripple & noise at 12Vin, 2.5V/15A out

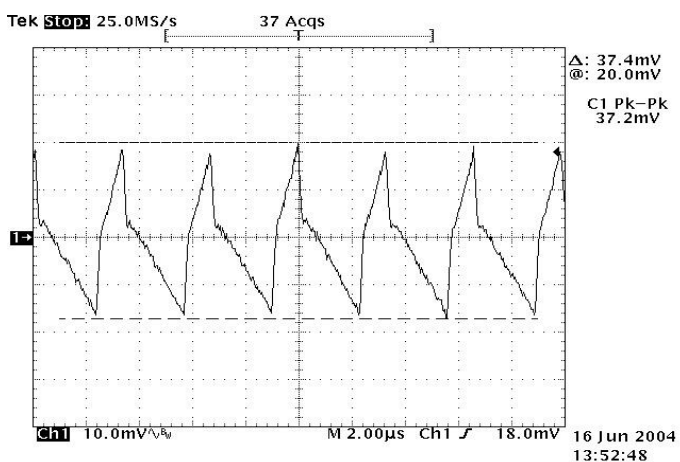


Figure 11: Output ripple & noise at 12Vin, 3.3V/15A out

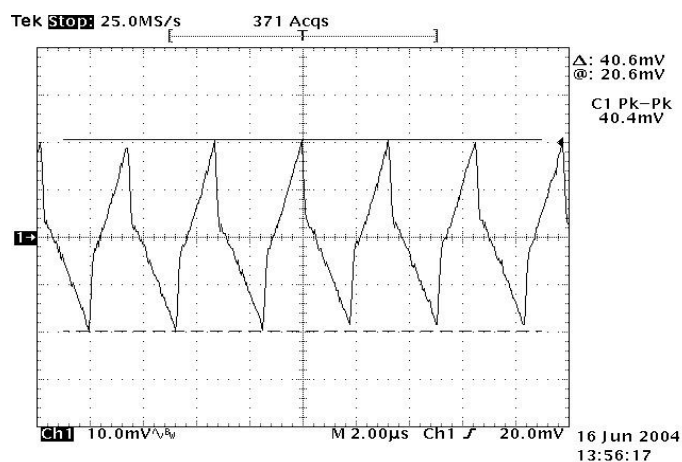
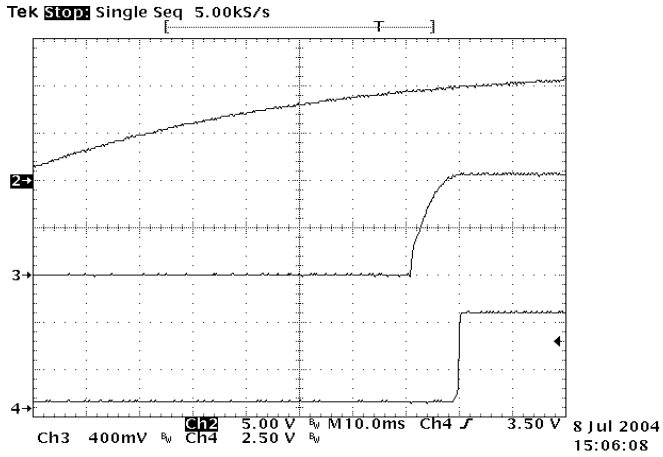


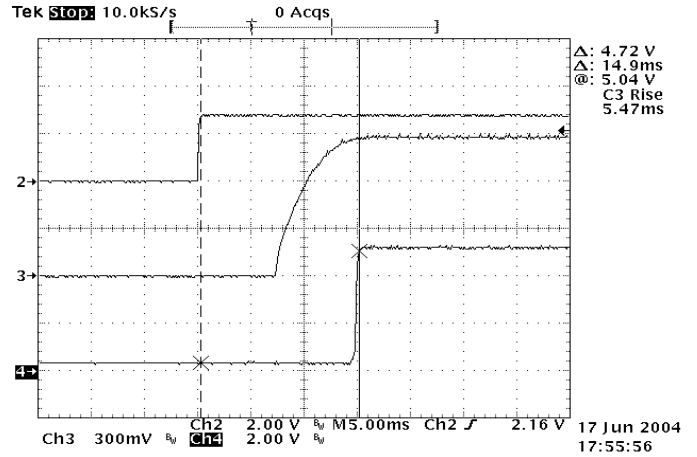
Figure 12: Output ripple & noise at 12Vin, 5.0V/15A out



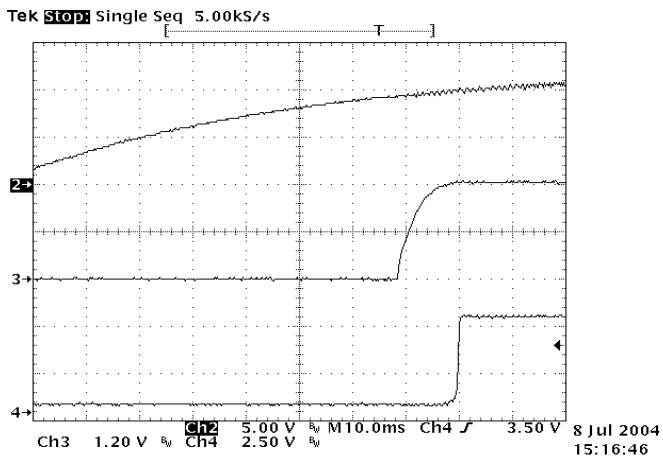
# ELECTRICAL CHARACTERISTICS CURVES



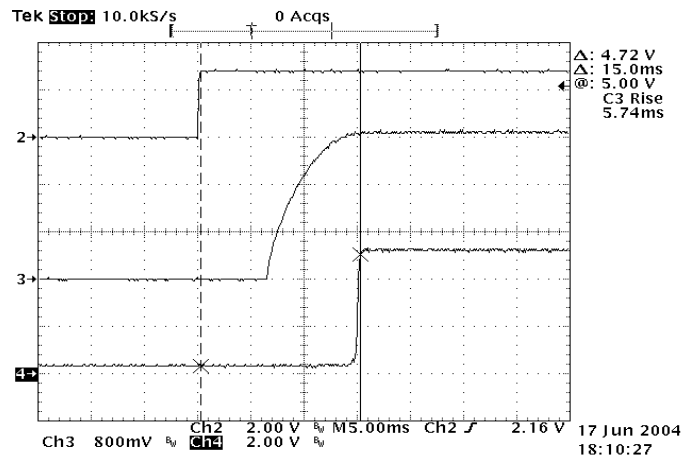
**Figure 13:** Turn on delay time at 12Vin, 0.9V/15A out  
Ch2:Vin Ch3:Vout Ch4:PWRGD



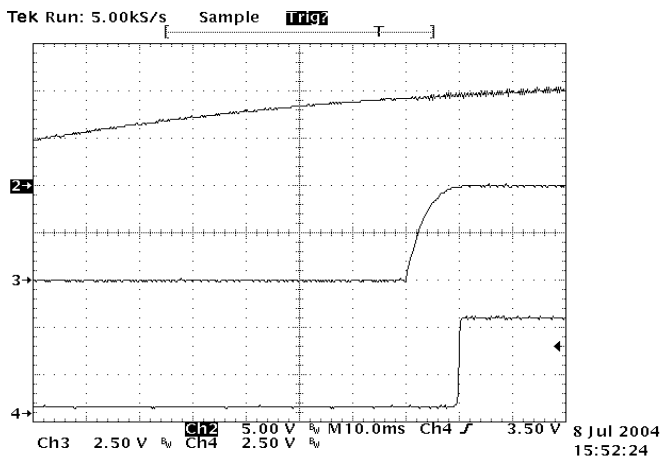
**Figure 14:** Turn on delay time Remote On/Off, 0.9V/15A out  
Ch2:ENABLE Ch3:Vout Ch4:PWRGD



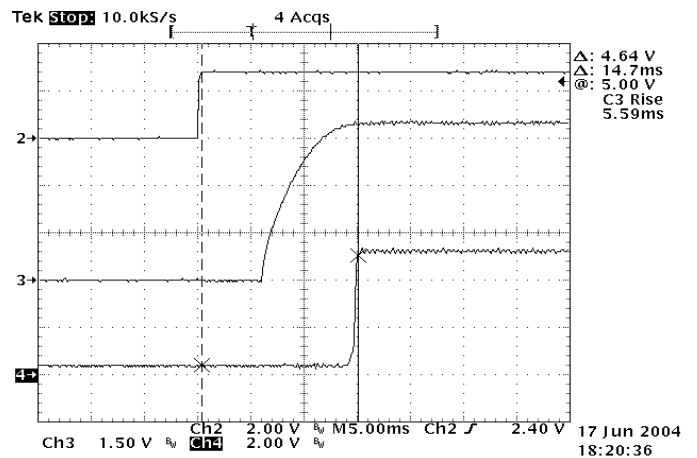
**Figure 15:** Turn on delay time at 12Vin, 2.5V/15A out  
Ch2:Vin Ch3:Vout Ch4:PWRGD



**Figure 16:** Turn on delay time at Remote On/Off, 2.5V/15A out  
Ch2:ENABLE Ch3:Vout Ch4:PWRGD



**Figure 17:** Turn on delay time at 12Vin, 5.0V/15A out  
Ch2:Vin Ch3:Vout Ch4:PWRGD

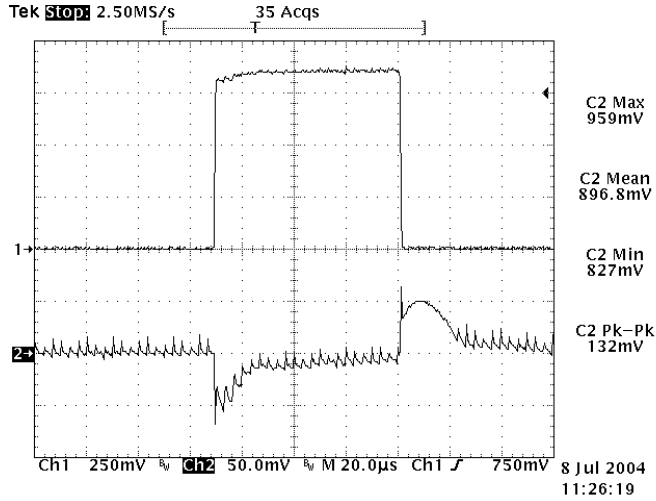


**Figure 18:** Turn on delay time at Remote On/Off, 5.0V/15A out  
Ch2:ENABLE Ch3:Vout Ch4:PWRGD

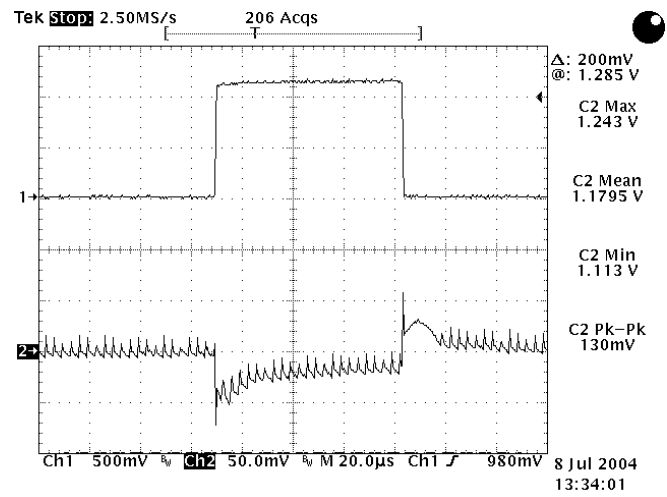




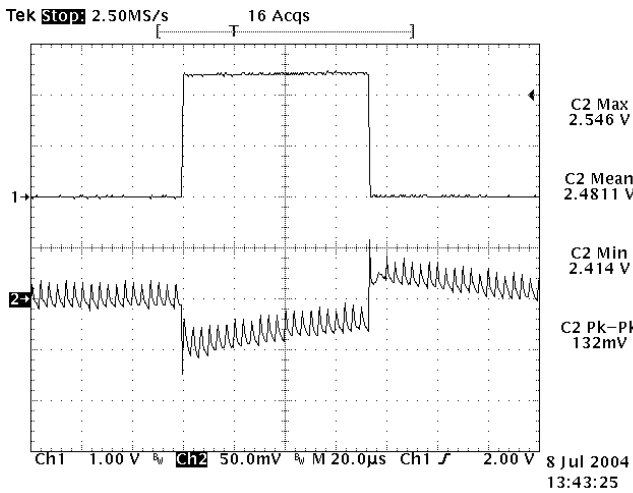
# ELECTRICAL CHARACTERISTICS CURVES



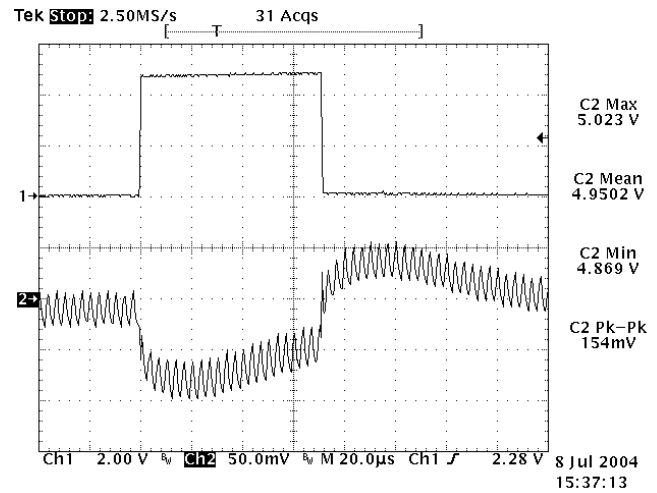
**Figure 19:** Typical transient response to step load change at  $10A/\mu S$  from 50% to 75% and 75% to 50% of  $I_{o\_max}$  at  $12V_{in}$ ,  $0.9V$  out



**Figure 20:** Typical transient response to step load change at  $10A/\mu S$  from 50% to 75% and 75% to 50% of  $I_{o\_max}$  at  $12V_{in}$ ,  $1.2V$  out



**Figure 21:** Typical transient response to step load change at  $10A/\mu S$  from 50% to 75% and 75% to 50% of  $I_{o\_max}$  at  $12V_{in}$ ,  $2.5V$  out



**Figure 22:** Typical transient response to step load change at  $10A/\mu S$  from 50% to 75% and 75% to 50% of  $I_{o\_max}$  at  $12V_{in}$ ,  $5.0V$  out

## DESIGN CONSIDERATIONS

The NC15 is a single phase and voltage mode controlled Buck topology. Block diagram of the converter is shown in Figure 23. The output can be trimmed in the range of 0.9Vdc to 5.0Vdc by a resistor from Trim pin to Ground.

The converter can be turned ON/OFF by remote control. Positive on/off (ENABLE pin) logic implies that the converter DC output is enabled when this signal is driven high (greater than 2.4V) or floating and disabled when the signal is driven low (below 0.8V). Negative on/off logic is optional and could also be ordered.

The converter provides an open collector signal called Power Good. The power good signal is pulled low when output is not within  $\pm 10\%$  of  $V_{out}$  or Enable is OFF.

The converter can protect itself by entering hiccup mode against over current and short circuit condition. Also, the converter will shut down when an over voltage protection is detected.

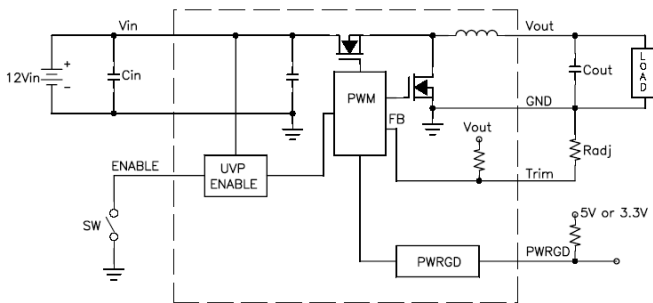


Figure 23: Block Diagram

## Safety Considerations

It is recommended that the user to provide a very fast-acting type fuse in the input line for safety. The output voltage set-point and the output current in the application could define the current rating of the fuse.

## FEATURES DESCRIPTIONS

### ENABLE (On/Off)

The ENABLE (on/off) input allows external circuitry to put the NC converter into a low power dissipation (sleep) mode. Positive (active-high) ENABLE is available as standard.

Positive ENABLE (active-high) units of the NC series are turned on if the ENABLE pin is high or floating. Pulling the pin low will turn off the unit. With the active high function, the output is guaranteed to turn on if the ENABLE pin is driven above 2.4V. The output will turn off if the ENABLE pin voltage is pulled below .8V.

The ENABLE input can be driven in a variety of ways as shown in Figures 24, 25 and 26. If the ENABLE signal comes from the primary side of the circuit, the ENABLE can be driven through either a bipolar signal transistor (Figure 24) or a logic gate (Figure 25). If the enable signal comes from the secondary side, then an opto-coupler or other isolation devices must be used to bring the signal across the voltage isolation (please see Figure 26).

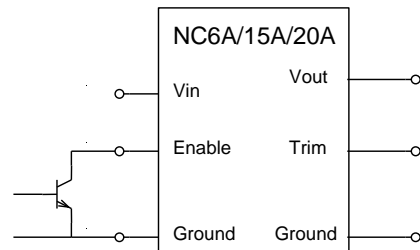


Figure 24: Enable Input drive circuit for NC series

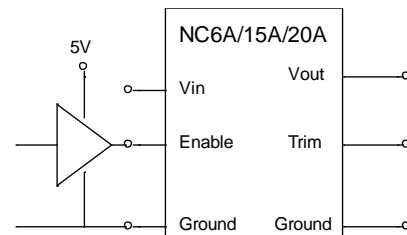


Figure 25: Enable input drive circuit using logic gate.

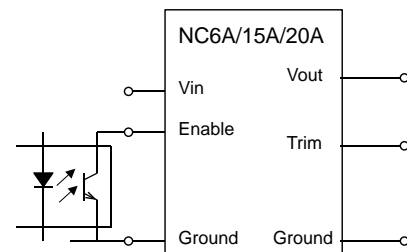


Figure 26: Enable input drive circuit example with isolation.

## FEATURES DESCRIPTIONS (CON.)

### Input Under-Voltage Lockout

The input under-voltage lockout prevents the converter from being damaged while operating when the input voltage is too low. The lockout occurs between 7.0V to 8.0V.

### Over-Current and Short-Circuit Protection

The NC series modules have non-latching over-current and short-circuit protection circuitry. When over current condition occurs, the module goes into the non-latching hiccup mode. When the over-current condition is removed, the module will resume normal operation.

An over current condition is detected by measuring the voltage drop across the high-side MOSFET. The voltage drop across the MOSFET is also a function of the MOSFET's  $R_{ds(on)}$ .  $R_{ds(on)}$  is affected by temperature, therefore ambient temperature will affect the current limit inception point. Please see the electrical characteristics for details of the OCP function.

The detection of the  $R_{ds(on)}$  of the high side MOSFET also acts as an over temperature protection since high temperature will cause the  $R_{ds(on)}$  of the MOSFET to increase, eventually triggering over-current protection.

### Output Voltage Programming

The output voltage of the NC series is trimmable by connecting an external resistor between the trim pin and output ground as shown Figure 27 and the typical trim resistor values are shown in Figure 28. The output can also be set by an external voltage connected to trim pin as shown in Figure 29.

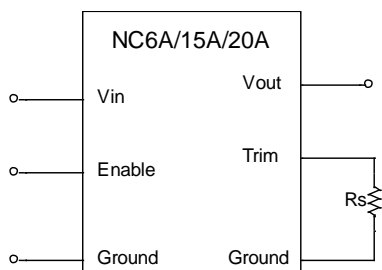


Figure 27: Trimming Output Voltage

The NC06/NC15/NC20 module has a trim range of 0.9V to 5.0V. The trim resistor equation for the NC6A/NC15A/ NC20A is :

$$R_s(\Omega) = \frac{1170}{V_{out} - 0.9}$$

$V_{out}$  is the output voltage setpoint

$R_s$  is the resistance between Trim and Ground

$R_s$  values should not be less than 280 $\Omega$

Output Voltage	$R_s$ ( $\Omega$ )
+0.9 V	OPEN
+1.2 V	3.92K
+1.5 V	1.96K
+1.8 V	1.3K
+2.5 V	732
+3.3 V	487
+5.0 V	287

Figure 28: Typical trim resistor values

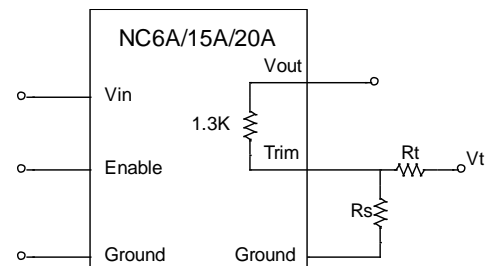


Figure 29: Output voltage trim with voltage source

To use voltage trim, the trim equation for the NC6A/NC15A/ NC20A is (please refer to Fig. 29) :

$$R_t(k\Omega) = \frac{R_s(1.3V_t - 1.17)}{1.17 - R_s(V_{out} - 0.9)}$$

$V_{out}$  is the desired output voltage

$V_t$  is the external trim voltage

$R_s$  is the resistance between Trim and Ground (in K $\Omega$ )

$R_t$  is the resistor to be defined with the trim voltage (in K $\Omega$ )

Below is an example about using this voltage trim equation :

#### Example :

If  $V_t = 1.25V$ , desired  $V_{out} = 2.5V$  and  $R_s = 0.715K\Omega$

$$R_t(K\Omega) = \frac{R_s(1.3V_t - 1.17)}{1.17 - R_s(V_{out} - 0.9)} = 12.51K\Omega$$



## FEATURES DESCRIPTIONS (CON.)

### Power Good

The converter provides an open collector signal called Power Good. This output pin uses positive logic and is open collector. This power good output is able to sink 5mA and set high when the output is within  $\pm 10\%$  of output set point.

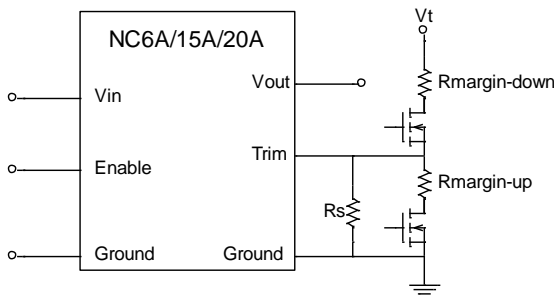
The power good signal is pulled low when output is not within  $\pm 10\%$  of  $V_{out}$  or Enable is OFF.

### Current Sink Capability

The NC series converters are able to sink current as well as function as a current source. It is able to sink the full output current at any output voltage up to and including 2.5V. This feature allows the NC series fit into any voltage termination application.

### Voltage Margining Adjustment

Output voltage margin adjusting can be implemented in the NC modules by connecting a resistor,  $R_{margin-up}$ , from the Trim pin to the Ground for for margining up the output voltage. Also, the output voltage can be adjusted lower by connecting a resistor,  $R_{margin-down}$ , from the Trim pin to the voltage source  $V_t$ . Figure 30 shows the circuit configuration for output voltage margining adjustment.



**Figure 30:** Circuit configuration for output voltage margining

### Paralleling

NC06/NC15/NC20 converters do not have built-in current sharing (paralleling) ability. Hence, paralleling of multiple NC06/NC15/NC20 converters is not recommended.

### Output Capacitance

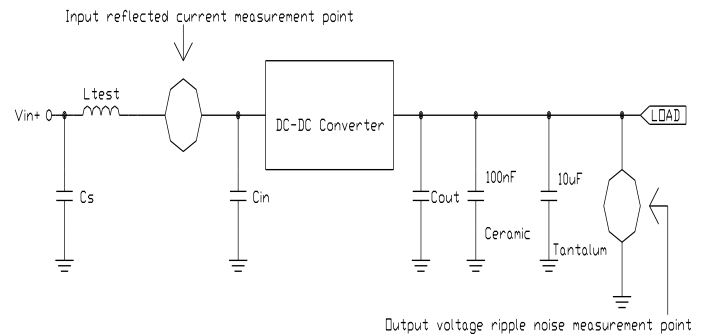
There is no output capacitor on the NC series modules. Hence, an external output capacitor is required for stable operation. For NC15 modules, an external 6.3V/680 $\mu$ F low ESR capacitor (for example, OSCON) is required for stable operation.

It is important to place these low ESR capacitors as close to the load as possible in order to get improved dynamic response and better voltage regulation, especially when the load current is large. Several of these low ESR capacitors could be used together to further lower the ESR.

Please refer to individual datasheet for the maximum allowed start-up load capacitance for each NC series as it is varied between series.

### Reflected Ripple Current and Output Ripple and Noise Measurement

The measurement set-up outlined in Figure 31 has been used for both input reflected/ terminal ripple current and output voltage ripple and noise measurements on NC series converters.



$$C_s=270\mu\text{F} * 1, L_{test}=1.4\mu\text{H}, C_{in}=270\mu\text{F} * 1, C_{out}=680\mu\text{F} * 1$$

**Figure 31:** Input reflected ripple/ capacitor ripple current and output voltage ripple and noise measurement setup for NC15



## **THERMAL CONSIDERATION**

Thermal management is an important part of the system design. To ensure proper, reliable operation, sufficient cooling of the power module is needed over the entire temperature range of the module. Convection cooling is usually the dominant mode of heat transfer.

Hence, the choice of equipment to characterize the thermal performance of the power module is a wind tunnel.

### **Thermal Testing Setup**

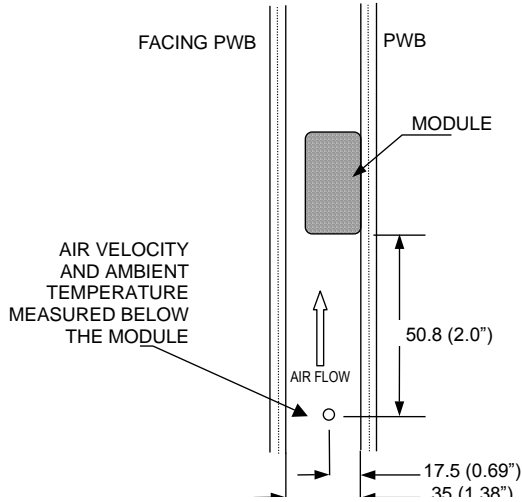
Delta's DC/DC power modules are characterized in heated vertical wind tunnels that simulate the thermal environments encountered in most electronics equipment. This type of equipment commonly uses vertically mounted circuit cards in cabinet racks in which the power modules are mounted.

The following figure shows the wind tunnel characterization setup. The power module is mounted on a test PWB and is vertically positioned within the wind tunnel. The space between the neighboring PWB and the top of the power module is constantly kept at 6.35mm (0.25").

### **Thermal Derating**

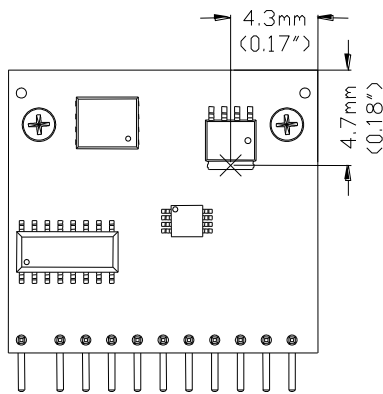
Heat can be removed by increasing airflow over the module. To enhance system reliability, the power module should always be operated below the maximum operating temperature. If the temperature exceeds the maximum module temperature, reliability of the unit may be affected.

# THERMAL CURVES (NC12S0A0V15)



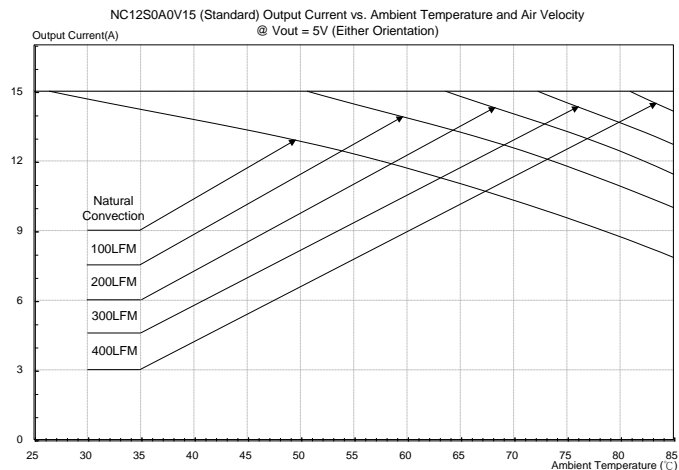
**Note:** Wind Tunnel Test Setup Figure Dimensions are in millimeters and (Inches)

**Figure 32:** Wind tunnel test setup

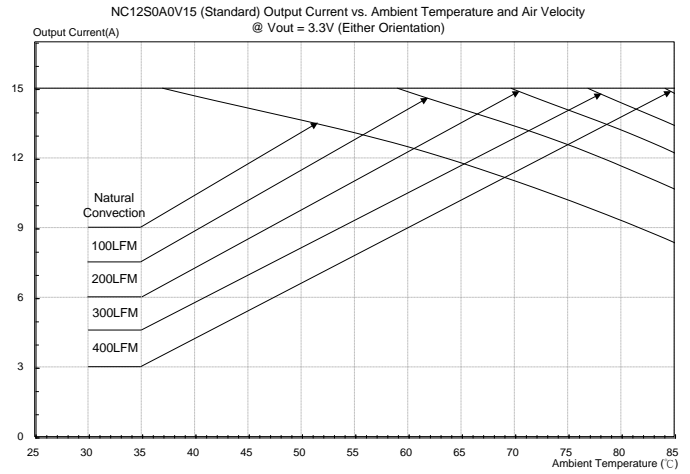


**Figure 33:** Temperature measurement location

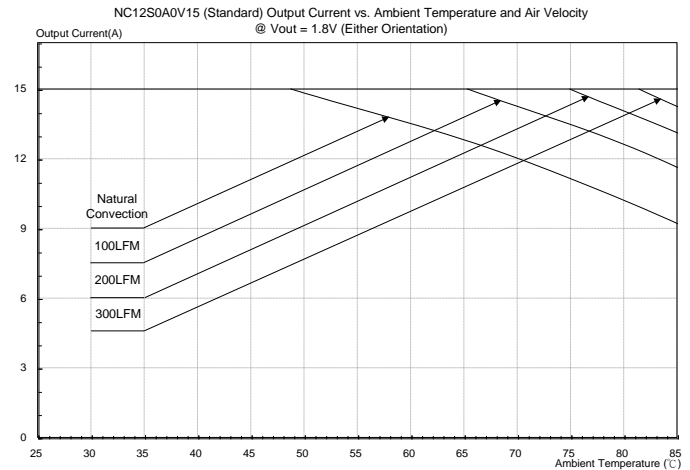
\* The allowed maximum hot spot temperature is defined at 130 °C



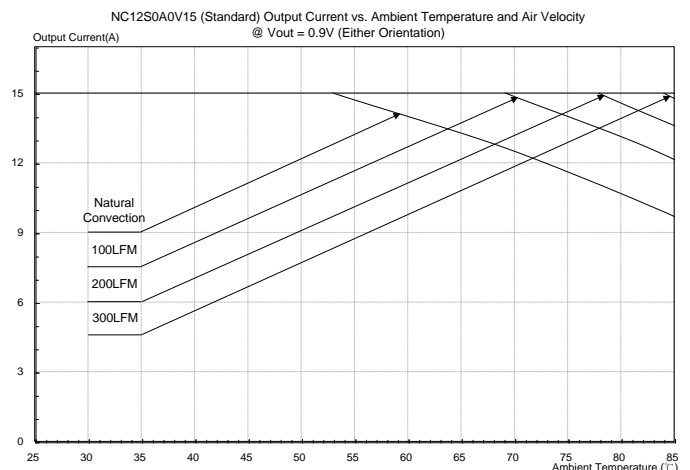
**Figure 34:** Output current vs. ambient temperature and air velocity @ Vout=5V (Either Orientation)



**Figure 35:** Output current vs. ambient temperature and air velocity @ Vout=3.3V (Either Orientation)

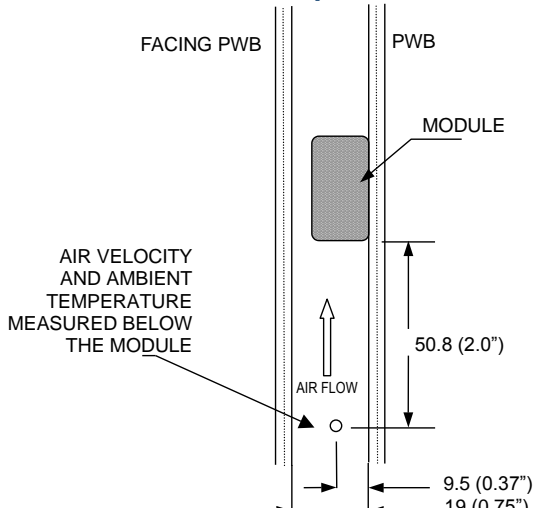


**Figure 36:** Output current vs. ambient temperature and air velocity @ Vout=1.8V (Either Orientation)



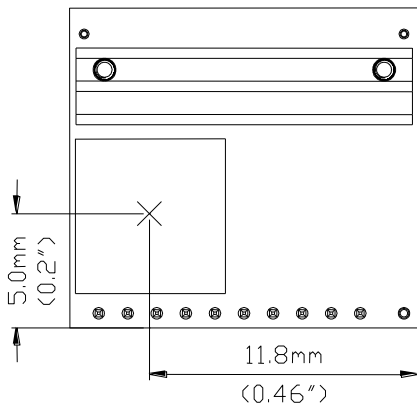
**Figure 37:** Output current vs. ambient temperature and air velocity @ Vout=0.9V (Either Orientation)

# THERMAL CURVES (NC12S0A0H15)



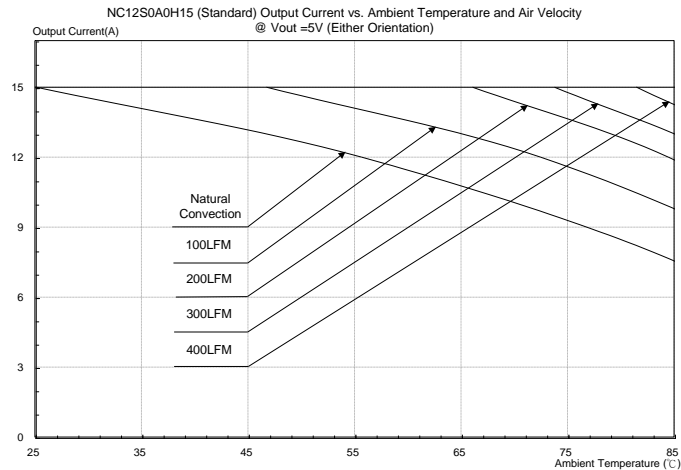
**Note:** Wind Tunnel Test Setup Figure Dimensions are in millimeters and (Inches)

**Figure 38:** Wind tunnel test setup

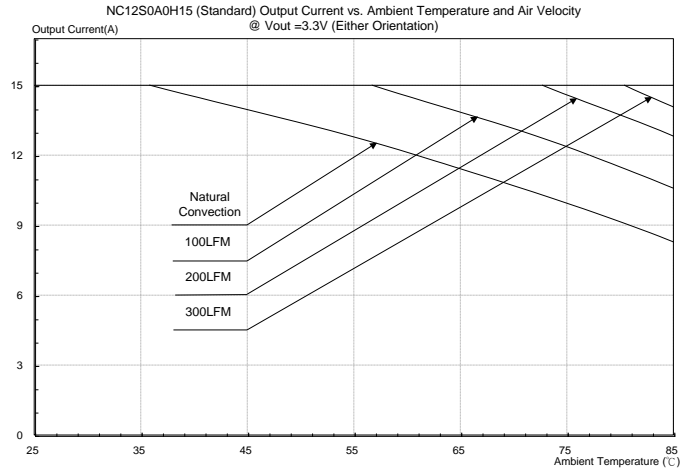


**Figure 39:** Temperature measurement location

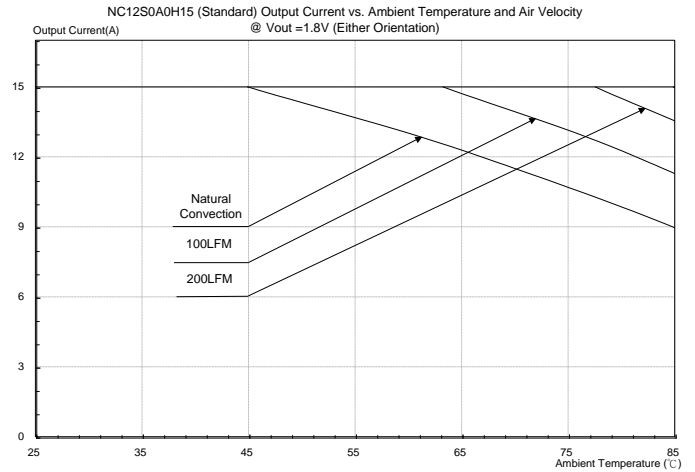
\* The allowed maximum hot spot temperature is defined at 125 °C



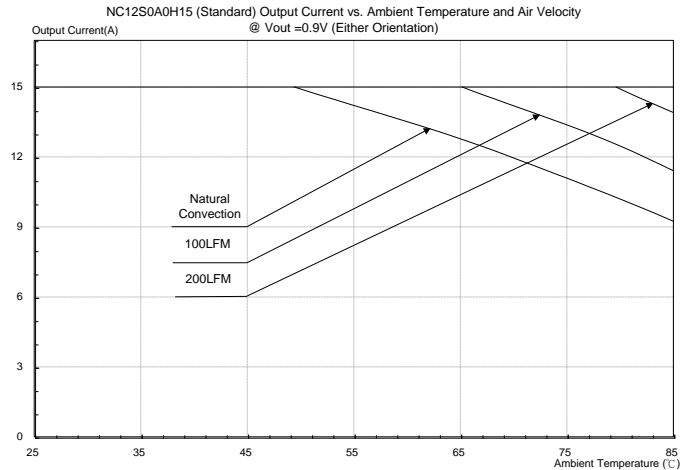
**Figure 40:** Output current vs. ambient temperature and air velocity @Vout=5V(Either Orientation)



**Figure 41:** Output current vs. ambient temperature and air velocity @ Vout=3.3V(Either Orientation)



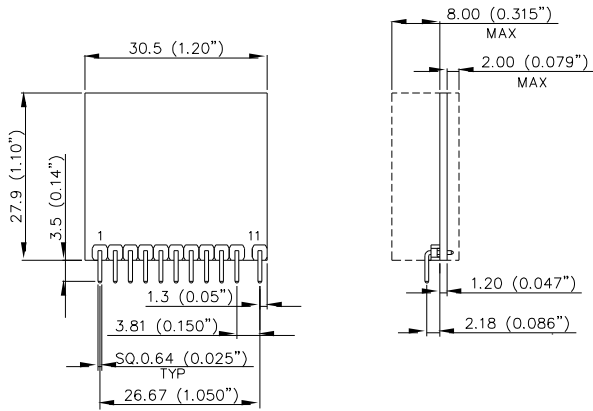
**Figure 42:** Output current vs. ambient temperature and air velocity @ Vout=1.8V(Either Orientation)



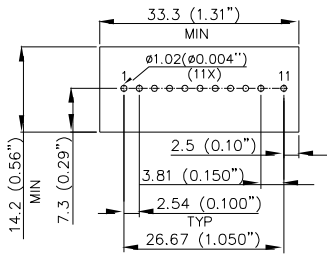
**Figure 43:** Output current vs. ambient temperature and air velocity @ Vout=0.9V(Either Orientation)

# MECHANICAL DRAWING

## VERTICAL



SUGGESTED PCB LAYOUT

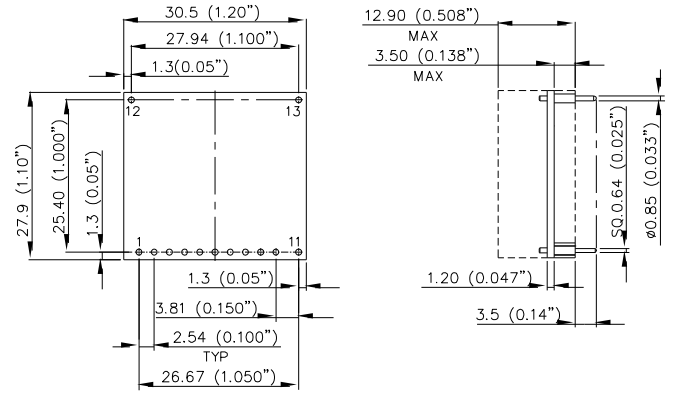


PIN ASSIGNMENT

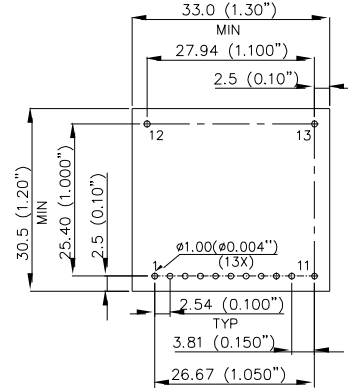
PIN#	FUNCTION
1	Vout
2	Vout
3	Vout
4	Trim
5	Enable
6	Power Good
7	Ground
8	Ground
9	Reserved
10	Vin
11	Vin

NOTES:  
 DIMENSIONS ARE IN MILLIMETERS AND (INCHS)  
 TOLERANCE: X.X mm±0.5 mm(X.XX in.±0.02 in.)  
 X.XX mm±0.25 mm(X.XXX in.±0.010 in.)

## HORIZONTAL



SUGGESTED PCB LAYOUT



PIN ASSIGNMENT

PIN#	FUNCTION
1	Vout
2	Vout
3	Vout
4	Trim
5	Enable
6	Power Good
7	Ground
8	Ground
9	Reserved
10	Vin
11	Vin
12	Mechanical Support
13	Mechanical Support



## PART NUMBERING SYSTEM

NC	12	S	0A0	V	15	P	N	F	A
Product Series	Input Voltage	Number of outputs	Output Voltage	Mounting	Output Current	ON/OFF Logic	Pin Length		Option Code
NC- Non-isolated Converter	12- 10.2~13.8V	S- Single output	0A0- programmable	H- Horizontal V- Vertical	15 - 15A	P- Positive N- Negative	R- 0.118" N- 0.14"	F- RoHS 6/6 (Lead Free)	A- Standard function.

## MODEL LIST

Model Name	Packaging	Input Voltage	Output Voltage	Output Current	Efficiency 12Vin @ 100% load
NC12S0A0V15PNFA	Vertical	10.2 ~ 13.8Vdc	0.9 V ~ 5.0Vdc	15A	91% (5.0V)
NC12S0A0H15PNFA	Horizontal	10.2 ~ 13.8Vdc	0.9 V ~ 5.0Vdc	15A	91% (5.0V)

### CONTACT: [www.deltaww.com/dcdc](http://www.deltaww.com/dcdc)

#### USA:

Telephone:  
East Coast: 978-656-3993  
West Coast: 510-668-5100  
Fax: (978) 656 3964  
Email: [DCDC@delta-corp.com](mailto:DCDC@delta-corp.com)

#### Europe:

Telephone: +31-20-655-0967  
Fax: +31-20-655-0999  
Email: [DCDC@delta-es.com](mailto:DCDC@delta-es.com)

#### Asia & the rest of world:

Telephone: +886 3 4526107 x6220~6224  
Fax: +886 3 4513485  
Email: [DCDC@delta.com.tw](mailto:DCDC@delta.com.tw)

## WARRANTY

Delta offers a two (2) year limited warranty. Complete warranty information is listed on our web site or is available upon request from Delta.

Information furnished by Delta is believed to be accurate and reliable. However, no responsibility is assumed by Delta for its use, nor for any infringements of patents or other rights of third parties, which may result from its use. No license is granted by implication or otherwise under any patent or patent rights of Delta. Delta reserves the right to revise these specifications at any time, without notice.

Компания «Океан Электроники» предлагает заключение долгосрочных отношений при поставках импортных электронных компонентов на взаимовыгодных условиях!

Наши преимущества:

- Поставка оригинальных импортных электронных компонентов напрямую с производств Америки, Европы и Азии, а так же с крупнейших складов мира;
- Широкая линейка поставок активных и пассивных импортных электронных компонентов (более 30 млн. наименований);
- Поставка сложных, дефицитных, либо снятых с производства позиций;
- Оперативные сроки поставки под заказ (от 5 рабочих дней);
- Экспресс доставка в любую точку России;
- Помощь Конструкторского Отдела и консультации квалифицированных инженеров;
- Техническая поддержка проекта, помощь в подборе аналогов, поставка прототипов;
- Поставка электронных компонентов под контролем ВП;
- Система менеджмента качества сертифицирована по Международному стандарту ISO 9001;
- При необходимости вся продукция военного и аэрокосмического назначения проходит испытания и сертификацию в лаборатории (по согласованию с заказчиком);
- Поставка специализированных компонентов военного и аэрокосмического уровня качества (Xilinx, Altera, Analog Devices, Intersil, Interpoint, Microsemi, Actel, Aeroflex, Peregrine, VPT, Syfer, Eurofarad, Texas Instruments, MS Kennedy, Miteq, Cobham, E2V, MA-COM, Hittite, Mini-Circuits, General Dynamics и др.);

Компания «Океан Электроники» является официальным дистрибьютором и эксклюзивным представителем в России одного из крупнейших производителей разъемов военного и аэрокосмического назначения «JONHON», а так же официальным дистрибьютором и эксклюзивным представителем в России производителя высокотехнологичных и надежных решений для передачи СВЧ сигналов «FORSTAR».



## JONHON

«JONHON» (основан в 1970 г.)

Разъемы специального, военного и аэрокосмического назначения:

(Применяются в военной, авиационной, аэрокосмической, морской, железнодорожной, горно- и нефтедобывающей отраслях промышленности)

«FORSTAR» (основан в 1998 г.)

ВЧ соединители, коаксиальные кабели, кабельные сборки и микроволновые компоненты:

(Применяются в телекоммуникациях гражданского и специального назначения, в средствах связи, РЛС, а так же военной, авиационной и аэрокосмической отраслях промышленности).



Телефон: 8 (812) 309-75-97 (многоканальный)

Факс: 8 (812) 320-03-32

Электронная почта: [ocean@oceanchips.ru](mailto:ocean@oceanchips.ru)

Web: <http://oceanchips.ru/>

Адрес: 198099, г. Санкт-Петербург, ул. Калинина, д. 2, корп. 4, лит. А