



# Micropower, Single-Supply, Rail-to-Rail Precision Differential Amplifiers

## General Description

The MAX4198/MAX4199 low-power, rail-to-rail differential amplifiers are ideal for single-supply applications that benefit from a low 0.01% gain error. The MAX4198 is factory trimmed to a fixed gain of +1V/V, and the MAX4199 is trimmed to a fixed gain of +10V/V. Capable of operating from a single +2.7V to +7.5V supply or from dual  $\pm 1.35\text{V}$  to  $\pm 3.75\text{V}$  supplies, they consume only 42 $\mu\text{A}$  while achieving -3dB bandwidths of 175kHz (MAX4198) and 45kHz (MAX4199). These amplifiers feature a shutdown mode that reduces the supply current to 6.5 $\mu\text{A}$ .

The MAX4198/MAX4199 can drive 5k $\Omega$  loads to within 100mV from each rail. The standard differential amplifier configurations provide common-mode rejection of 90dB for the MAX4198 and 110dB for the MAX4199. The input common-mode voltage range for the MAX4198 extends 100mV Beyond-the-Rails™.

The MAX4198/MAX4199 are offered in a space-saving 8-pin  $\mu\text{MAX}$  package. For complete micropower, rail-to-rail instrumentation amplifiers, see the MAX4194–MAX4197 data sheet.

## Applications

Instrumentation Amplifier Building Block  
 Differential Voltage Amplifiers  
 Data-Acquisition Systems  
 Portable/Battery-Powered Equipment  
 Transducer Interface  
 Current-Sense Amplifiers

## Functional Diagram



Beyond-the-Rails is a trademark of Maxim Integrated Products, Inc.

## Features

- ◆ Low 0.01% Gain Error
- ◆ High Common-Mode Rejection: 110dB (MAX4199)
- ◆ 10 $\mu\text{V}$  Input Offset Voltage (MAX4199)  
30 $\mu\text{V}$  Input Offset Voltage (MAX4198)
- ◆ +2.7V to +7.5V Single-Supply Operation
- ◆ 42 $\mu\text{A}$  Supply Current
- ◆ 175kHz (MAX4198) and 45kHz (MAX4199)  
-3dB Bandwidth
- ◆ 6.5 $\mu\text{A}$  Shutdown Current
- ◆ Rail-to-Rail Outputs Drive 5k $\Omega$  Loads
- ◆ Input Voltage Range Extends 100mV Beyond-the-Rails (MAX4198)
- ◆ Available in Space-Saving 8-Pin  $\mu\text{MAX}$  Package

## Ordering Information

PART	TEMP RANGE	PIN-PACKAGE	GAIN (V/V)
MAX4198EUA	-40°C to +85°C	8 $\mu\text{MAX}$	1
MAX4198ESA	-40°C to +85°C	8 SO	1
MAX4199EUA	-40°C to +85°C	8 $\mu\text{MAX}$	10
MAX4199ESA	-40°C to +85°C	8 SO	10

## Pin Configuration

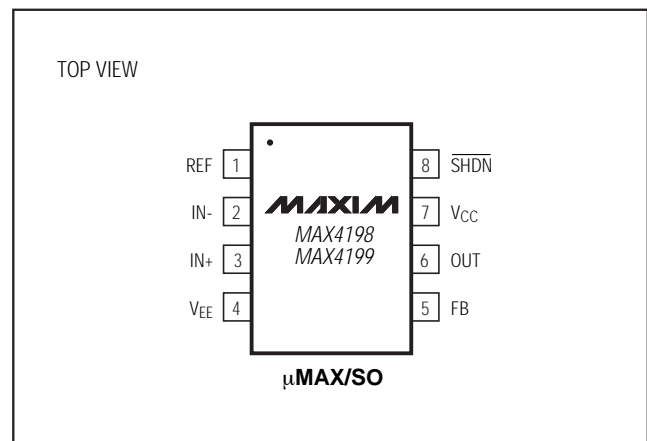

# Micropower, Single-Supply, Rail-to-Rail Precision Differential Amplifiers

## ABSOLUTE MAXIMUM RATINGS

Supply Voltage ( $V_{CC}$  to  $V_{EE}$ ) .....+8V  
 All Other Pins to GND .....( $V_{EE} - 0.3V$ ) to ( $V_{CC} + 0.3V$ )  
 Output Short-Circuit Duration (to  $V_{CC}$  or  $V_{EE}$ ).....Continuous  
 Continuous Power Dissipation ( $T_A = +70^\circ\text{C}$ )  
   8-Pin SO (derate 9.09mW/ $^\circ\text{C}$  above  $+70^\circ\text{C}$ ).....471mW  
   8-Pin  $\mu\text{MAX}$  (derate 4.1mW/ $^\circ\text{C}$  above  $+70^\circ\text{C}$ ).....330mW

Operating Temperature Range .....-40 $^\circ\text{C}$  to +85 $^\circ\text{C}$   
 Junction Temperature.....+150 $^\circ\text{C}$   
 Storage Temperature Range ..... -65 $^\circ\text{C}$  to +150 $^\circ\text{C}$   
 Lead Temperature (soldering, 10s) .....+300 $^\circ\text{C}$

Stresses beyond those listed under "Absolute Maximum Ratings" may cause permanent damage to the device. These are stress ratings only, and functional operation of the device at these or any other conditions beyond those indicated in the operational sections of the specifications is not implied. Exposure to absolute maximum rating conditions for extended periods may affect device reliability.

## ELECTRICAL CHARACTERISTICS—MAX4198 (+5V Supply)

( $V_{CC} = +5V$ ,  $V_{EE} = 0V$ ,  $R_L = 25k\Omega$  tied to  $V_{CC} / 2$ ,  $V_{REF} = V_{CC} / 2$ ,  $V_{SHDN} = V_{CC} - 1.5V$ , typical values are at  $T_A = +25^\circ\text{C}$ ,  $T_A = T_{MIN}$  to  $T_{MAX}$ , unless otherwise noted.) (Note 1)

PARAMETER	SYMBOL	CONDITIONS	MIN	TYP	MAX	UNITS
Supply Voltage Range (Note 2)	$V_{CC}$	Single supply	2.7		7.5	V
		Dual supply	$\pm 1.35$		$\pm 3.75$	
Input Offset Voltage	$V_{OS}$	$T_A = +25^\circ\text{C}$ , $V_{CM} = V_{CC} / 2$	MAX4198ESA	$\pm 30$	$\pm 500$	$\mu\text{V}$
			MAX4198EUA	$\pm 100$	$\pm 1000$	
		$T_A = T_{MIN}$ to $T_{MAX}$ , $V_{CM} = V_{CC} / 2$	MAX4198ESA		$\pm 750$	
			MAX4198EUA		$\pm 2300$	
Input Offset Voltage Drift	TCO	MAX4198ESA		$\pm 0.5$	$\pm 5$	$\mu\text{V}/^\circ\text{C}$
		MAX4198EUA		$\pm 1$	$\pm 20$	
Input Resistance	$R_{IN}$	IN+ differential-mode		50		$k\Omega$
		IN- differential-mode		25		
		Common-mode		50		
Input Voltage Range	$V_{IN}$	Guaranteed by CMR test	$V_{EE} - 0.1$		$V_{CC} + 0.1$	V
DC Common-Mode Rejection	CMR <sub>DC</sub>	$V_{CM} = V_{EE} - 0.1V$ to $V_{CC} + 0.1V$	MAX4198ESA	74	90	dB
			MAX4198EUA	70	90	
AC Common-Mode Rejection	CMR <sub>AC</sub>	$V_{CM} = V_{EE} - 0.1$ to $V_{CC} + 0.1V$ , $f = 60\text{Hz}$ , $f = 120\text{Hz}$		90		dB
Power-Supply Rejection	PSR	$+2.7V \leq V_{CC} \leq +7.5V$ , $V_{CM} = +1.5V$ , $V_{REF} = +1.5V$ , $R_L = 25k\Omega$ to $+1.5V$	90	115		dB
Input Noise Voltage		$f = 10\text{Hz}$		120		$n\text{V}/\sqrt{\text{Hz}}$
		$f = 100\text{Hz}$		60		
		$f = 10\text{kHz}$		58		
		$f = 0.1\text{Hz}$ to $10\text{Hz}$		7.8		$\mu\text{VRMS}$
Output Voltage Swing		$R_L = 25k\Omega$ , $\pm 10\text{mV}$ input overdrive	$V_{EE} + 0.1$	$V_{EE} + 0.03$ to $V_{CC} - 0.1$	$V_{CC} - 0.03$	V
		$R_L = 5k\Omega$ , $\pm 10\text{mV}$ input overdrive	$V_{EE} + 0.2$	$V_{EE} + 0.1$ to $V_{CC} - 0.2$	$V_{CC} - 0.1$	
Short-Circuit Current		Sink/source		$\pm 5.5$		mA
Gain Error		$V_{CM} = V_{CC} / 2$ , $T_A = +25^\circ\text{C}$	$R_L = 25k\Omega$ , $V_{EE} + 0.1V \leq$ $V_{OUT} \leq V_{CC} - 0.1V$	$\pm 0.01$	$\pm 0.1$	%
			$R_L = 5k\Omega$ , $V_{EE} + 0.2V \leq$ $V_{OUT} \leq V_{CC} - 0.2V$	$\pm 0.01$	$\pm 0.1$	
Gain Temperature Coefficient		$V_{EE} + 0.1V \leq$ $V_{OUT} \leq V_{CC} -$ $0.1V$	MAX4198ESA	$\pm 0.2$	$\pm 3$	ppm/ $^\circ\text{C}$
			MAX4198EUA	$\pm 0.65$	$\pm 6$	
Nonlinearity		$V_{EE} + 0.1V \leq V_{OUT} \leq V_{CC} - 0.1V$		$\pm 0.0003$		%

# Micropower, Single-Supply, Rail-to-Rail Precision Differential Amplifiers

MAX4198/MAX4199

## ELECTRICAL CHARACTERISTICS—MAX4198 (+5V Supply) (continued)

( $V_{CC} = +5V$ ,  $V_{EE} = 0V$ ,  $R_L = 25k\Omega$  tied to  $V_{CC} / 2$ ,  $V_{REF} = V_{CC} / 2$ ,  $V_{SHDN} = V_{CC} - 1.5V$ , typical values are at  $T_A = +25^\circ C$ ,  $T_A = T_{MIN}$  to  $T_{MAX}$ , unless otherwise noted.) (Note 1)

PARAMETER	SYMBOL	CONDITIONS	MIN	TYP	MAX	UNITS
Capacitive-Load Stability	$C_L$			690		pF
-3dB Bandwidth	BW-3dB	$V_{OUT} \leq 0.1V_{P-P}$ , $V_{CM} = V_{CC} / 2$		175		kHz
Slew Rate	SR	$V_{OUT} = 2V_{P-P}$ step		0.07		V/ $\mu$ s
Settling Time to 0.1%	$t_s$	$V_{OUT} = 2V_{P-P}$ step		34		$\mu$ s
Total Harmonic Distortion	THD	$V_{OUT} = 2V_{P-P}$ , $f = 1kHz$		0.001		%
Supply Current	$I_{CC}$	$V_{CM} = V_{CC} / 2$ , $V_{IN+} = V_{IN-}$		45	55	$\mu$ A
Shutdown Supply Current	$I_{SHDN}$	$V_{SHDN} = V_{IL}$		6.5	12	$\mu$ A
Input Logic Voltage High (Note 3)	$V_{IH}$		$V_{CC} - 1.5$			V
Input Logic Voltage Low (Note 3)	$V_{IL}$			$V_{CC} - 2.5$		V
SHDN Input Bias Current		$V_{SHDN} = V_{CC} - 1.5V$ or $V_{SHDN} = V_{EE}$	-0.1		0.1	$\mu$ A
Enable/Disable Settling Time	$t_{ON/OFF}$	$V_{SHDN} = V_{CC} - 2.5V$ to $V_{CC} - 1.5V$ , $V_{OUT} = 3.5V$ , settled to within 0.1%		28		$\mu$ s
Power-Up Delay		$V_{OUT} = 3.5V$ , settled to within 0.1%		800		$\mu$ s

## ELECTRICAL CHARACTERISTICS—MAX4198 (+3V Supply)

( $V_{CC} = +3V$ ,  $V_{EE} = 0V$ ,  $R_L = 25k\Omega$  tied to  $V_{CC} / 2$ ,  $V_{REF} = V_{CC} / 2$ ,  $V_{SHDN} = V_{CC} - 1.5V$ , typical values are at  $T_A = +25^\circ C$ ,  $T_A = T_{MIN}$  to  $T_{MAX}$ , unless otherwise noted.) (Note 1)

PARAMETER	SYMBOL	CONDITIONS	MIN	TYP	MAX	UNITS
Input Offset Voltage	$V_{OS}$	$T_A = +25^\circ C$ , $V_{CM} = V_{CC} / 2$	MAX4198ESA	$\pm 35$	$\pm 600$	$\mu$ V
			MAX4198EUA	$\pm 100$	$\pm 1100$	
		$T_A = T_{MIN}$ to $T_{MAX}$ , $V_{CM} = V_{CC} / 2$	MAX4198ESA		$\pm 850$	
			MAX4198EUA		$\pm 2400$	
Input Offset Voltage Drift	TCO	MAX4198ESA		$\pm 0.5$	$\pm 5.0$	$\mu$ V/ $^\circ C$
		MAX4198EUA		$\pm 1.0$	$\pm 20$	
Input Voltage Range	$V_{IN}$	Guaranteed by CMR test	$V_{EE} - 0.1$		$V_{CC} + 0.1$	V
DC Common-Mode Rejection	CMR <sub>DC</sub>	$V_{CM} = V_{EE} - 0.1$ to $V_{CC} + 0.1$	MAX4198ESA	74	90	dB
			MAX4198EUA	70	90	
Output Voltage Swing		$R_L = 25k\Omega$ , $\pm 10mV$ input overdrive	$V_{EE} + 0.1$ to $V_{CC} - 0.1$	$V_{EE} + 0.03$ to $V_{CC} - 0.03$		V
		$R_L = 5k\Omega$ , $\pm 10mV$ input overdrive	$V_{EE} + 0.2$ to $V_{CC} - 0.2$	$V_{EE} + 0.1$ to $V_{CC} - 0.1$		
Short-Circuit Current		Sink/source		$\pm 4.5$		mA
Gain Error		$V_{CM} = V_{CC} / 2$ , $T_A = +25^\circ C$	$R_L = 25k\Omega$ , $V_{EE} + 0.1V \leq$ $V_{OUT} \leq V_{CC} - 0.1V$	$\pm 0.01$	$\pm 0.1$	%
			$R_L = 5k\Omega$ , $V_{EE} + 0.2V \leq$ $V_{OUT} \leq V_{CC} - 0.2V$	$\pm 0.01$	$\pm 0.1$	
Gain Temperature Coefficient		$V_{EE} + 0.1V \leq$ $V_{OUT} \leq V_{CC} - 0.1V$	MAX4198ESA	$\pm 0.2$	$\pm 3$	ppm/ $^\circ C$
			MAX4198EUA	$\pm 0.65$	$\pm 6$	
Supply Current	$I_{CC}$	$V_{CM} = V_{CC} / 2$ , $V_{DIFF} = 0V$		42		$\mu$ A
Shutdown Supply Current	$I_{SHDN}$			6.5		$\mu$ A
Input Logic High Voltage (Note 3)	$V_{IH}$		$V_{CC} - 1.5$			V
Input Logic Low Voltage (Note 3)	$V_{IL}$			$V_{CC} - 2.5$		V

# Micropower, Single-Supply, Rail-to-Rail Precision Differential Amplifiers

MAX4198/MAX4199

## ELECTRICAL CHARACTERISTICS—MAX4199 (+5V Supply)

( $V_{CC} = +5V$ ,  $V_{EE} = 0V$ ,  $R_L = 25k\Omega$  tied to  $V_{CC} / 2$ ,  $V_{REF} = V_{CC} / 2$ ,  $V_{SHDN} = V_{CC} - 1.5V$ , typical values are at  $T_A = +25^\circ C$ ,  $T_A = T_{MIN}$  to  $T_{MAX}$ , unless otherwise noted.) (Note 1)

PARAMETER	SYMBOL	CONDITIONS		MIN	TYP	MAX	UNITS	
Supply Voltage Range (Note 2)	$V_{CC}$	Single supply		2.7		7.5	V	
		Dual supply		$\pm 1.35$		$\pm 3.75$		
Input Offset Voltage	$V_{OS}$	$T_A = +25^\circ C$ , $V_{CM} = V_{CC} / 2$	MAX4199ESA		$\pm 10$	$\pm 300$	$\mu V$	
			MAX4199EUA		$\pm 100$	$\pm 600$		
		$T_A = T_{MIN}$ to $T_{MAX}$ , $V_{CM} = V_{CC} / 2$	MAX4199ESA			$\pm 500$		
			MAX4199EUA			$\pm 1475$		
Input Offset Voltage Drift	TCO	MAX4199ESA			$\pm 0.25$	$\pm 3$	$\mu V / ^\circ C$	
		MAX4199EUA			$\pm 0.75$	$\pm 15$		
Input Resistance	$R_{IN}$	IN+ differential mode			275		$k\Omega$	
		IN- differential mode			25			
		Common-mode			275			
Input Voltage Range (Note 2)	$V_{IN}$	Guaranteed by CMR test		$V_{EE} - 0.1$		$V_{CC} - 1.0$	V	
DC Common-Mode Rejection	CMR <sub>DC</sub>	$V_{CM} = V_{EE} - 0.1V$ to $V_{CC} - 1.0V$	MAX4199ESA	76	110		dB	
			MAX4199EUA	76	110			
AC Common-Mode Rejection	CMR <sub>AC</sub>	$V_{CM} = V_{EE} - 0.1V$ to $V_{CC} - 1.0V$ , $f = 60Hz$			110		dB	
Power-Supply Rejection	PSR	$+2.7V \leq V_{CC} \leq +7.5V$ , $V_{CM} = +1.5V$ , $V_{REF} = +1.5V$ , $R_L = 25k\Omega$ to $+1.5V$		90	120		dB	
Input Noise Voltage		$f = 10Hz$			60		$nV/\sqrt{Hz}$	
		$f = 100Hz$			40			
		$f = 10kHz$			38			
		$f = 0.1Hz$ to $10Hz$			6.6		$\mu V_{RMS}$	
Output Voltage Swing		$R_L = 25k\Omega$ , $\pm 10mV$ input overdrive		$V_{EE} + 0.1$ to $V_{CC} - 0.1$	$V_{EE} + 0.02$ to $V_{CC} - 0.02$		V	
		$R_L = 5k\Omega$ , $\pm 10mV$ input overdrive		$V_{EE} + 0.2$ to $V_{CC} - 0.2$	$V_{EE} + 0.1$ to $V_{CC} - 0.1$			
Short-Circuit Current		Sink/source			$\pm 5.5$		mA	
Gain Error		$V_{CM} = V_{CC} / 2$ , $T_A = +25^\circ C$	$R_L = 25k\Omega$ , $V_{EE} + 0.1V \leq$ $V_{OUT} \leq V_{CC} - 0.1V$		$\pm 0.01$	$\pm 0.3$	%	
			$R_L = 5k\Omega$ , $V_{EE} + 0.2V \leq$ $V_{OUT} \leq V_{CC} - 0.2V$		$\pm 0.01$	$\pm 0.3$		
Gain Temperature Coefficient		$V_{EE} + 0.1V \leq$ $V_{OUT} \leq V_{CC} - 0.1V$	MAX4199ESA		$\pm 1$	$\pm 5$	ppm/ $^\circ C$	
			MAX4199EUA		$\pm 2$	$\pm 10$		
Nonlinearity		$V_{EE} + 0.1V \leq V_{OUT} \leq V_{CC} - 0.1V$			$\pm 0.0003$		%	
Capacitive-Load Stability	$C_L$				600		pF	
-3dB Bandwidth	BW <sub>-3dB</sub>	$V_{OUT} \leq 0.1V_{P-P}$ , $V_{CM} = V_{CC} / 2$			45		kHz	
Slew Rate	SR	$V_{OUT} = 2V_{P-P}$			0.1		V/ $\mu s$	
Settling Time to 0.1%	$t_s$	$V_{OUT} = 2V_{P-P}$ step			37		$\mu s$	
Total Harmonic Distortion	THD	$V_{OUT} = 2V_{P-P}$ , $f = 1kHz$			0.001		%	
Supply Current	$I_{CC}$	$V_{CM} = V_{CC} / 2$ , $V_{IN+} = V_{IN-}$			45	55	$\mu A$	
Shutdown Supply Current	$I_{SHDN}$	$V_{SHDN} = V_{IL}$			6.5	12	$\mu A$	

# Micropower, Single-Supply, Rail-to-Rail Precision Differential Amplifiers

MAX4198/MAX4199

## ELECTRICAL CHARACTERISTICS—MAX4199 (+5V Supply) (continued)

( $V_{CC} = +5V$ ,  $V_{EE} = 0V$ ,  $R_L = 25k\Omega$  tied to  $V_{CC} / 2$ ,  $V_{REF} = V_{CC} / 2$ ,  $V_{SHDN} = V_{CC} - 1.5V$ , typical values are at  $T_A = +25^\circ C$ ,  $T_A = T_{MIN}$  to  $T_{MAX}$ , unless otherwise noted.) (Note 1)

PARAMETER	SYMBOL	CONDITIONS	MIN	TYP	MAX	UNITS
Input Logic Voltage High (Note 3)	$V_{IH}$		$V_{CC} - 1.5$			V
Input Logic Voltage Low (Note 3)	$V_{IL}$			$V_{CC} - 2.5$		V
$\overline{SHDN}$ Input Bias Current		$V_{SHDN} = V_{CC} - 1.5V$ or $V_{SHDN} = V_{EE}$	-0.1		+0.1	$\mu A$
Enable/Disable Settling Time	$t_{ON/OFF}$	$V_{SHDN} = V_{CC} - 2.5V$ to $V_{CC} - 1.5V$ , $V_{OUT} = 3.5V$ , settled to within 0.1%		35		$\mu s$
Power-Up Delay		$V_{OUT} = 3.5V$ , settled to within 0.1%		800		$\mu s$

## ELECTRICAL CHARACTERISTICS—MAX4199 (+3V Supply)

( $V_{CC} = +3V$ ,  $V_{EE} = 0V$ ,  $R_L = 25k\Omega$  tied to  $V_{CC} / 2$ ,  $V_{REF} = V_{CC} / 2$ ,  $V_{SHDN} = V_{CC} - 1.5V$ , values are at  $T_A = +25^\circ C$ ,  $T_A = T_{MIN}$  to  $T_{MAX}$ , unless otherwise noted.) (Note 1)

PARAMETER	SYMBOL	CONDITIONS	MIN	TYP	MAX	UNITS
Input Offset Voltage	$V_{OS}$	$T_A = +25^\circ C$ , $V_{CM} = V_{CC} / 2$	MAX4199ESA	$\pm 15$	$\pm 400$	$\mu V$
			MAX4199EUA	$\pm 100$	$\pm 700$	
		$T_A = T_{MIN}$ to $T_{MAX}$ , $V_{CM} = V_{CC} / 2$	MAX4199ESA		$\pm 600$	
			MAX4199EUA		$\pm 1675$	
Input Offset Voltage Drift	$TCO$	MAX4199ESA	$\pm 0.25$	$\pm 5$	$\mu V/^\circ C$	
		MAX4199EUA	$\pm 0.75$	$\pm 15$		
Input Voltage Range	$V_{IN}$	Guaranteed by CMR test	$V_{EE} - 0.1$		$V_{CC} - 1.1$	V
DC Common-Mode Rejection	$CMR_{DC}$	$V_{CM} = V_{EE} - 0.1$ to $V_{CC} - 1.1$	MAX4199ESA	76	110	dB
			MAX4199EUA	76	110	
Output Voltage Swing		$R_L = 25k\Omega$ , $\pm 10mV$ input overdrive	$V_{EE} + 0.1$ to $V_{CC} - 0.1$	$V_{EE} + 0.02$ to $V_{CC} - 0.02$		V
		$R_L = 5k\Omega$ , $\pm 10mV$ input overdrive	$V_{EE} + 0.2$ to $V_{CC} - 0.2$	$V_{EE} + 0.1$ to $V_{CC} - 0.1$		
Short-Circuit Current		Sink/source		$\pm 4.5$		mA
Gain Error		$V_{CM} = V_{CC} / 2$ , $T_A = +25^\circ C$	$R_L = 25k\Omega$ , $V_{EE} + 0.1V \leq$ $V_{OUT} \leq V_{CC} - 0.1V$	$\pm 0.01$	$\pm 0.3$	%
			$R_L = 5k\Omega$ , $V_{EE} + 0.2V \leq$ $V_{OUT} \leq V_{CC} - 0.2V$	$\pm 0.01$	$\pm 0.3$	
Gain Temperature Coefficient		$V_{EE} + 0.1V \leq$ $V_{OUT} \leq V_{CC} - 0.1V$	MAX4199ESA	$\pm 1$	$\pm 5$	ppm/ $^\circ C$
			MAX4199EUA	$\pm 2$	$\pm 10$	
Supply Current	$I_{CC}$	$V_{CM} = V_{CC} / 2$ , $V_{DIFF} = 0V$		42		$\mu A$
Shutdown Supply Current	$I_{SHDN}$			6.5		$\mu A$
Input Logic High Voltage (Note 3)	$V_{IH}$		$V_{CC} - 1.5$			V
Input Logic Low Voltage (Note 3)	$V_{IL}$			$V_{CC} - 2.5$		V

**Note 1:** The MAX4198EUA and the MAX4199EUA are 100% production tested at  $+25^\circ C$ . All temperature limits are guaranteed by design.

**Note 2:** Guaranteed by PSR test.

**Note 3:** When shutdown input is at logic high, the part is active; when at logic low, the part is in shutdown.

# Micropower, Single-Supply, Rail-to-Rail Precision Differential Amplifiers

## Typical Operating Characteristics

( $V_{CC} = +5V$ ,  $V_{EE} = 0V$ ,  $R_L = 25k\Omega$  to  $V_{CC} / 2$ ,  $V_{SHDN} = V_{CC} - 1.5V$ , small-signal  $V_{OUT} = 100mV_{p-p}$ , large-signal  $V_{OUT} = 1V_{p-p}$ ,  $T_A = +25^\circ C$ , unless otherwise noted.)

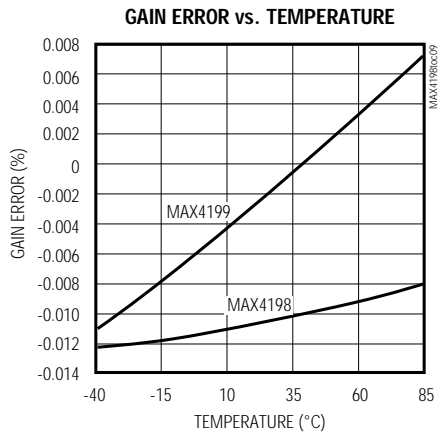
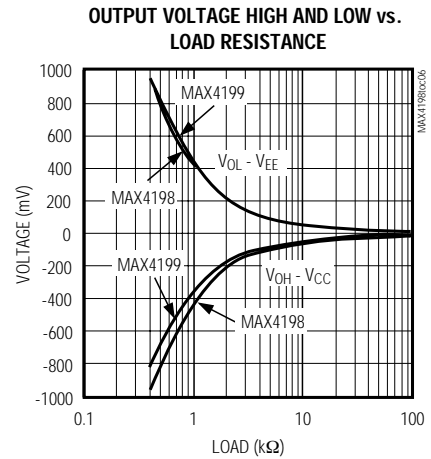
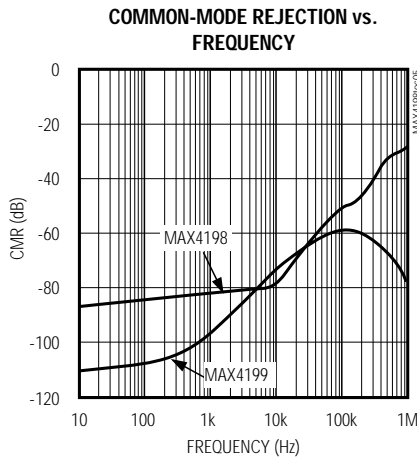

# Micropower, Single-Supply, Rail-to-Rail Precision Differential Amplifiers

## Typical Operating Characteristics (continued)

( $V_{CC} = +5V$ ,  $V_{EE} = 0V$ ,  $R_L = 25k\Omega$  to  $V_{CC} / 2$ ,  $V_{SHDN} = V_{CC} - 1.5V$ , small-signal  $V_{OUT} = 100mV_{p-p}$ , large-signal  $V_{OUT} = 1V_{p-p}$ ,  $T_A = +25^\circ C$ , unless otherwise noted.)

MAX4198/MAX4199

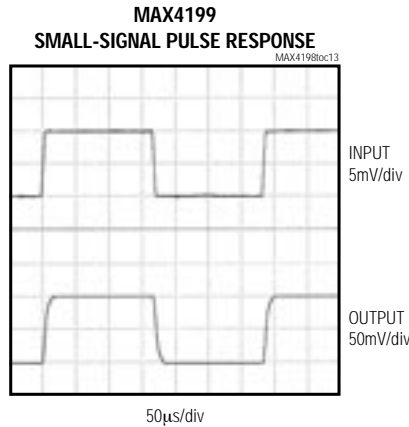
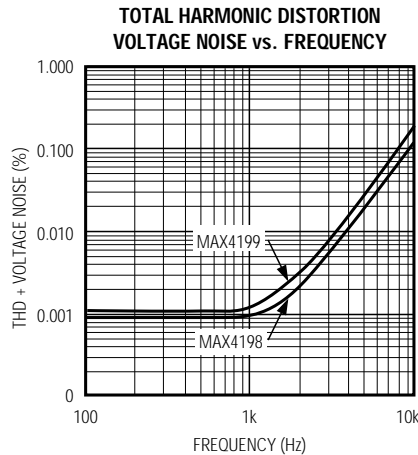
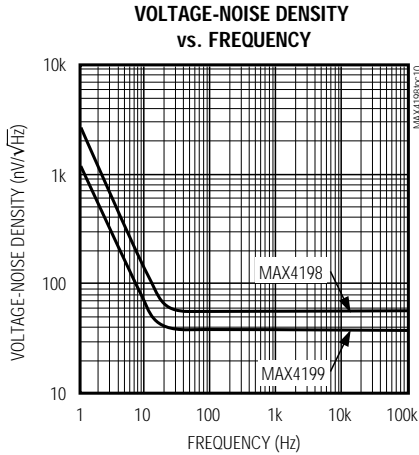

# Micropower, Single-Supply, Rail-to-Rail Precision Differential Amplifiers

## Typical Operating Characteristics (continued)

( $V_{CC} = +5V$ ,  $V_{EE} = 0V$ ,  $R_L = 25k\Omega$  to  $V_{CC} / 2$ ,  $V_{SHDN} = V_{CC} - 1.5V$ , small-signal  $V_{OUT} = 100mV_{p-p}$ , large-signal  $V_{OUT} = 1V_{p-p}$ ,  $T_A = +25^\circ C$ , unless otherwise noted.)

**MAX4199**  
SMALL-SIGNAL PULSE RESPONSE  
WITH CAPACITIVE LOAD



**MAX4199**  
SMALL-SIGNAL PULSE RESPONSE WITH  
EXCESSIVE CAPACITIVE LOAD



**MAX4199**  
SMALL-SIGNAL PULSE RESPONSE WITH  
EXCESSIVE CAPACITIVE LOAD  
AND ISOLATION RESISTOR



**MAX4198**  
TIME EXITING SHUTDOWN



**MAX4199**  
TIME EXITING SHUTDOWN



**MAX4198 HISTOGRAM**  
( $V_{OS}$  BASED ON 200 UNITS)



**MAX4199 HISTOGRAM**  
( $V_{OS}$  BASED ON 280 UNITS)

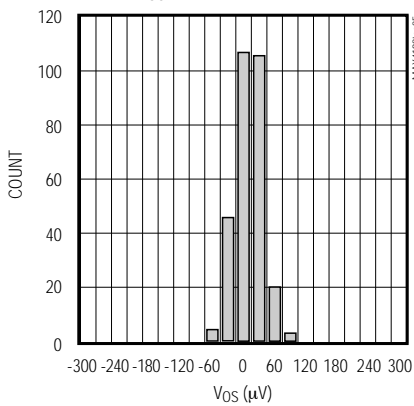

**MAX4198 HISTOGRAM**  
(GAIN ACCURACY BASED ON 200 UNITS)

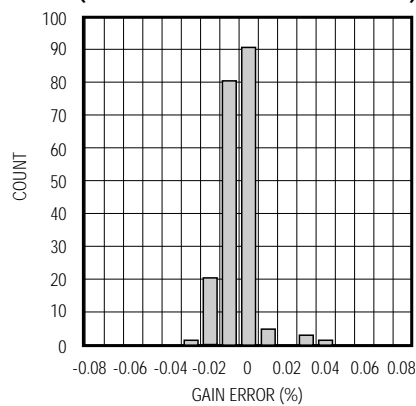

**MAX4199 HISTOGRAM**  
(GAIN ACCURACY BASED ON 280 UNITS)





# Micropower, Single-Supply, Rail-to-Rail Precision Differential Amplifiers

MAX4198/MAX4199

## Typical Operating Characteristics (continued)

( $V_{CC} = +5V$ ,  $V_{EE} = 0V$ ,  $R_L = 25k\Omega$  to  $V_{CC} / 2$ ,  $V_{SHDN} = V_{CC} - 1.5V$ , small-signal  $V_{OUT} = 100mV_{p-p}$ , large-signal  $V_{OUT} = 1V_{p-p}$ ,  $T_A = +25^\circ C$ , unless otherwise noted.)



## Pin Description

PIN	NAME	FUNCTION
1	REF	Reference Voltage Input. Offsets output voltage.
2	IN-	Inverting Input
3	IN+	Noninverting Input
4	$V_{EE}$	Negative Supply Voltage
5	FB	Feedback Resistor. Can be used as a sense input.
6	OUT	Amplifier Output
7	$V_{CC}$	Positive Supply Voltage
8	$\overline{SHDN}$	Shutdown Control. Shutdown threshold is referenced to $V_{CC}$ . When pulled 2.5V below $V_{CC}$ , part is in shutdown.

## Detailed Description

The MAX4198/MAX4199 are precision low-power differential amplifiers with factory-trimmed internal gain-setting resistors. The MAX4198 is trimmed to a gain of +1V/V and the MAX4199 is trimmed to a gain of +10V/V.

### Input Stage

The *Functional Diagram* shows the internal structure of the MAX4198/MAX4199. Although the resistors are precision matched, their absolute value varies by  $\pm 25\%$ . The typical input impedance for the MAX4198 is  $50k\Omega$  for the noninverting input and  $25k\Omega$  for the inverting input. The typical input impedance for the MAX4199 is  $275k\Omega$  for the noninverting input and  $25k\Omega$  for the inverting input.

The common-mode inputs of the internal op amp can range from  $V_{EE}$  to  $(V_{CC} - 1.1V)$ . Although the inputs to the internal op amp are not rail-to-rail, the internal resistors form a voltage divider that extends the input common-mode range beyond-the-rails for the MAX4198. The overall input range of the MAX4198 extends 100mV beyond-the-rails without adversely affecting common-mode rejection or undergoing phase reversal ( $V_{CC} = 5V$ ). The MAX4199 input common-mode range extends from 100mV below the negative rail to  $(V_{CC} - 1V)$  (see the Input Common-Mode Voltage Range vs. Supply Voltage graph in the *Typical Operating Characteristics*).

# Micropower, Single-Supply, Rail-to-Rail Precision Differential Amplifiers

## Rail-to-Rail Output Stage

The MAX4198/MAX4199 output stage incorporates a common-source rail-to-rail structure which maximizes the dynamic range of the differential amplifier. The output can swing to within 100mV from each rail with a 5k $\Omega$  load to  $V_{CC} / 2$  (see the *Typical Operating Characteristics*).

## Shutdown Mode

The MAX4198/MAX4199 have an active-low shutdown input. SHDN input logic thresholds are referenced to  $V_{CC}$ , not to GND. Pulling SHDN 2.5V below the positive rail places the amplifiers in a 12 $\mu$ A (max) shutdown mode. The MAX4198/MAX4199 exit or enter shutdown in 35 $\mu$ s. In shutdown, the OUT pin is high-impedance.

## Applications Information

### Driving Capacitive Loads

The MAX4198/MAX4199 are relatively immune to oscillations caused when driving large capacitive loads. Although heavy load capacitance increases transient ringing, sustained oscillations typically do not occur for loads under 600pF (see Pulse Response with Capacitive Load in the *Typical Operating Characteristics*). Applications that require driving higher capacitive loads can isolate the output capacitance using a 15 $\Omega$  to 100 $\Omega$  resistor between the amplifier output and the load (Figure 1). Although adding an isolation resistor dampens the response enough to prevent oscillations, it does so at the expense of bandwidth and DC accuracy.

### Power Supply Considerations

The MAX4198/MAX4199 operate from single +2.7V to +7.5V supplies or from dual  $\pm 1.35$ V to  $\pm 3.75$ V supplies, and they consume only 45 $\mu$ A of supply current. Excellent power-supply rejection permits the amplifiers to be operated directly from a decaying 3V cell without excessive error. To maximize AC performance, the supply must be bypassed with a 0.1 $\mu$ F ceramic capacitor to ground that must be as close as possible to the pin. If dual supplies are used, bypass both supply pins with 0.1 $\mu$ F to ground.

### Application Circuits

Differential amplifiers can be used in single-ended and other amplifier applications. Figures 2 through 6 show the MAX4198/MAX4199 in different configurations. The internally trimmed and matched resistors offer convenience and have a distinct advantage over external resistors. These amplifiers are not compensated for single-ended unity gain; therefore, IN- should not be connected to OUT or left unconnected.



Figure 1. Dual-Supply, Capacitive-Load Driving Circuit



Figure 2. Standard Difference Amplifier



Figure 3. Precision Inverting Buffer

# Micropower, Single-Supply, Rail-to-Rail Precision Differential Amplifiers

## Instrumentation Amplifier Applications

For applications that require a complete low-power instrumentation amplifier, refer to the MAX4194–MAX4197 data sheet. Some differential to single-ended voltage amplifier applications that do not require a high input impedance can use the MAX4198/MAX4199 for gains of +1V/V or +10V/V. The MAX4198/MAX4199 can

also be used as an instrumentation amplifier building block. The circuit of Figure 7 takes advantage of the 10pA (max), 0.1pA (typ) bias current of the MAX406A to form an instrumentation amplifier similar to the MAX4194 family, except with lower input bias currents. The MAX406A's low 1.2μA supply current maintains a low overall supply current.

MAX4198/MAX4199



Figure 4. Precision Gain of Two Amplifiers



Figure 5. Single-Supply Inverting Amplifier Biased at  $V_{CC} / 2$



Figure 6. Digitally Controlled Precision Gain of ±1 Amplifier



Figure 7. Ultra-Low Input Bias Current (0.1pA) Instrumentation Amplifiers with 47μA Supply-Current Consumption

# Micropower, Single-Supply, Rail-to-Rail Precision Differential Amplifiers

## Chip Information

TRANSISTOR COUNT: 250  
 SUBSTRATE CONNECTED TO VEE

## Package Information

(The package drawing(s) in this data sheet may not reflect the most current specifications. For the latest package outline information, go to [www.maxim-ic.com/packages](http://www.maxim-ic.com/packages).)

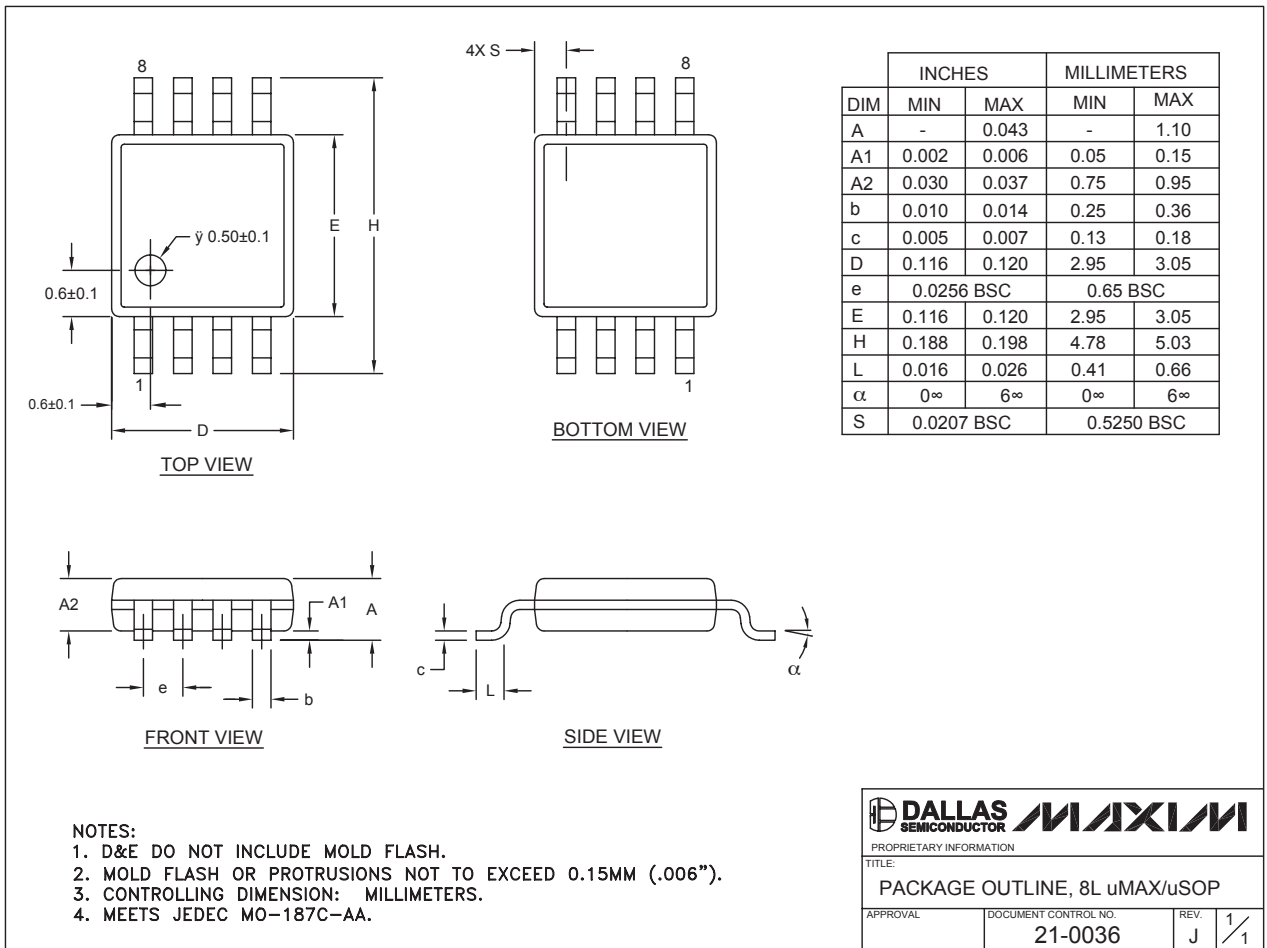

8LUMAXD.EPS

Maxim cannot assume responsibility for use of any circuitry other than circuitry entirely embodied in a Maxim product. No circuit patent licenses are implied. Maxim reserves the right to change the circuitry and specifications without notice at any time.

12 Maxim Integrated Products, 120 San Gabriel Drive, Sunnyvale, CA 94086 408-737-7600

Компания «Океан Электроники» предлагает заключение долгосрочных отношений при поставках импортных электронных компонентов на взаимовыгодных условиях!

Наши преимущества:

- Поставка оригинальных импортных электронных компонентов напрямую с производств Америки, Европы и Азии, а так же с крупнейших складов мира;
- Широкая линейка поставок активных и пассивных импортных электронных компонентов (более 30 млн. наименований);
- Поставка сложных, дефицитных, либо снятых с производства позиций;
- Оперативные сроки поставки под заказ (от 5 рабочих дней);
- Экспресс доставка в любую точку России;
- Помощь Конструкторского Отдела и консультации квалифицированных инженеров;
- Техническая поддержка проекта, помощь в подборе аналогов, поставка прототипов;
- Поставка электронных компонентов под контролем ВП;
- Система менеджмента качества сертифицирована по Международному стандарту ISO 9001;
- При необходимости вся продукция военного и аэрокосмического назначения проходит испытания и сертификацию в лаборатории (по согласованию с заказчиком);
- Поставка специализированных компонентов военного и аэрокосмического уровня качества (Xilinx, Altera, Analog Devices, Intersil, Interpoint, Microsemi, Actel, Aeroflex, Peregrine, VPT, Syfer, Eurofarad, Texas Instruments, MS Kennedy, Miteq, Cobham, E2V, MA-COM, Hittite, Mini-Circuits, General Dynamics и др.);

Компания «Океан Электроники» является официальным дистрибьютором и эксклюзивным представителем в России одного из крупнейших производителей разъемов военного и аэрокосмического назначения «JONHON», а так же официальным дистрибьютором и эксклюзивным представителем в России производителя высокотехнологичных и надежных решений для передачи СВЧ сигналов «FORSTAR».



## JONHON

«JONHON» (основан в 1970 г.)

Разъемы специального, военного и аэрокосмического назначения:

(Применяются в военной, авиационной, аэрокосмической, морской, железнодорожной, горно- и нефтедобывающей отраслях промышленности)

«FORSTAR» (основан в 1998 г.)

ВЧ соединители, коаксиальные кабели, кабельные сборки и микроволновые компоненты:

(Применяются в телекоммуникациях гражданского и специального назначения, в средствах связи, РЛС, а так же военной, авиационной и аэрокосмической отраслях промышленности).



Телефон: 8 (812) 309-75-97 (многоканальный)

Факс: 8 (812) 320-03-32

Электронная почта: [ocean@oceanchips.ru](mailto:ocean@oceanchips.ru)

Web: <http://oceanchips.ru/>

Адрес: 198099, г. Санкт-Петербург, ул. Калинина, д. 2, корп. 4, лит. А