

KUMP Series Panel Plug-in Relay

- 15 amp rating
- Contact arrangements 1-3 form A, 1-3 form B, 1-3 form C, 1 form X, 1 form Y, 1 form Z
- Open or enclosed
- Plain or bracket mount dust covers
- Optional indicator lamp and push-to-test button
- Several termination and mounting styles

Typical applications
Hospital beds, semiconductor wafer equipment, boom/bucket lifts.

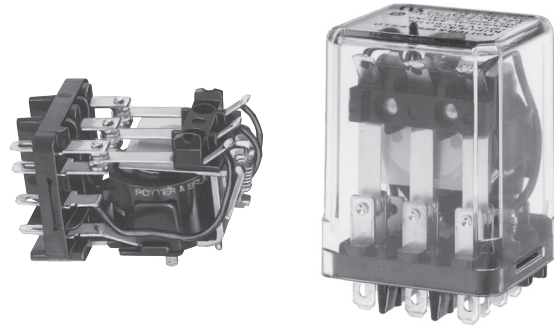

Approvals

UL E22575; CSA LR15734
Technical data of approved types on request.

Contact Data

Contact arrangement	1, 2 and 3 form A (NO); 1, 2 and 3 form B (NC); 1, 2 and 3 form C (CO); 1 form X (NO-DM); 1 form Y (NC-DB); 1 form Z (CO-DB-DM)	
Rated voltage	277VAC	
Rated current	15A	
Contact material	AgCdO	AgSnOInO
Min. recommended contact load	300mA, 12VDC	300mA, 12VDC
Frequency of operation	360 ops./hour	360 ops./hour
Operate/releases time max.	15/10ms	
Bounce time max.	17ms	

Contact ratings

Type	Load	Cycles
UL 508 AgCdO	15A, 277VAC 1/2HP, 120VAC 10A, 240VAC 10A, 32VDC 5FLA, 15LRA, 250VAC 5A, 120VAC, tungsten 0.5A, 250VAC 0.5A, 125VDC 10FLA, 40LRA, 125VAC 3A, 600VAC 1/2HP, 480VAC 1/2HP, 600VAC 1HP, 480VAC, 3 phase	
AgSnOInO	15A, 277VAC, pf = 0.8 10A, 277VAC, pf = 0.8	15x10 ³ 100x10 ³
Mechanical endurance		10x10 ⁶ ops.

Coil Data

Coil voltage range	5 to 110VDC 6 to 240VAC
Coil insulation system according UL	Class B

Coil versions, DC coil

Coil code	Rated voltage VDC	Operate voltage VDC	Coil resistance Ω±10%	Rated coil power W
5	5	3.75	21	1.2
6	6	4.5	32.1	1.125
12	12	9.0	120	1.2
24	24	18.0	472	1.25
48	48	36.0	1800	1.3
110	110	82.5	10000	1.25

All figures are given for coil without preenergization, at ambient temperature +23°C.

Coil versions, AC coil

Coil code	Rated voltage VAC	Operate voltage VAC	Coil resistance Ω±15%	Rated coil power VA
6	6	5.1	4.2	2.8
12	12	10.2	18	2.8
24	24	20.4	72	2.8
120	120	102.0	1700	2.9
240	240	204.0	7200	2.9

All figures are given for coil without preenergization, at ambient temperature +23°C.

Insulation Data

Initial dielectric strength	
between open contacts	1200V _{rms}
between contact and coil	2200V _{rms}
between adjacent contacts	2200V _{rms}
Initial insulation resistance	
between insulated elements	100MΩ, 500VDC

Other Data

Material compliance: EU RoHS/ELV, China RoHS, REACH, Halogen content refer to the Product Compliance Support Center at www.te.com/customer-support/rohssupportcenter

Ambient temperature	
DC coil	Enclosed relays: -45°C to 70°C Open relays: 15°C higher maximum
AC coil	Enclosed relays, 3 pole: -45°C to +45°C Enclosed relays, 1 and 2 pole: -45°C to +55°C Open relays: 15°C higher maximum
Category of environmental protection	IEC 61810 RT0 - open relay; RTI - dust protected
Terminal type	Quick connects (QC), .187, .205 or .250: PCB-THT
Terminal retention, push force	
QC .205	17 lbs for 3s
QC .187, QC .250, PCB	25 lbs for 3s
Weight	85g
Packaging/unit	tray/25 pcs., box/150pcs.

Accessories

For details see datasheet Sockets and Accessories, KUP Relays

Product Code	Description
27E893	DIN socket (use 20C318 clip)
27E121	Track mount socket (use 20C314 clips)
27E043	Chassis mount/solder eyelet socket (use 20C254 clip)
27E046	Chassis mount/PCB socket (use 20C254 clip)
27E067	Chassis mount/quick connect socket (use 20C254 clip)
27E396	Snap-in/quick connect socket (use 20C254 clip)

KUMP Series Panel Plug-in Relay (Continued)

Dimensions

KUM bracket type

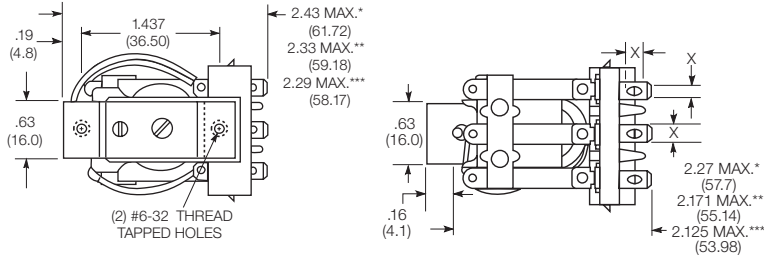

KUM stud type

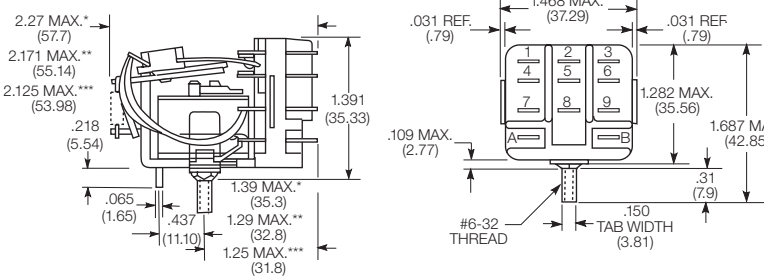

Seated Heights For KUM (open) Relays

1.391" (35.33mm) for #6-32 stud with .218" (5.54mm) locating tab.

1.52" (38.6mm) for bracket with 2-#6 32 tapped holes.

1.282" (32.56mm) for #6-32 tapped core with .125" (3.18mm) or .218" (5.54mm) locating tab.

2.046" (51.97mm) for relay with printed circuit terminals.

STUD TYPE also available with .125" (3.18mm) tab, as well as without stud and locating tab. Models without stud have core tapped #6-32 THREAD, .25" (6.4mm) minimum depth.

*Dimensions with .250" (6.35mm) terminals.

** Dimensions with .110" (2.79mm) or .205"(5.21mm) terminals.

*** Dimensions with .187" (4.75mm) terminals.

KUMP plain case

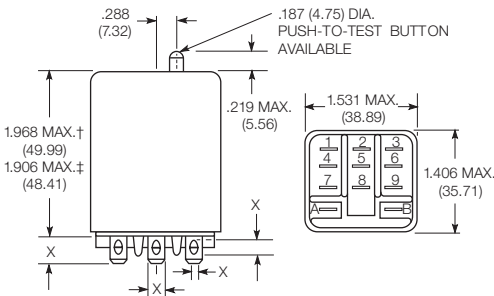

KUMP core / stud mount case

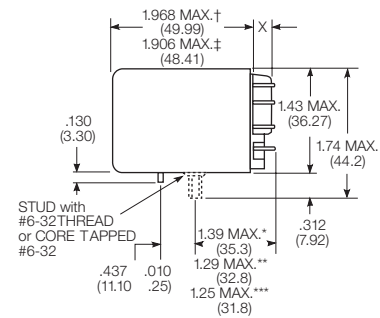

X Is For Terminal Dimensions. See Terminal Drawings.

KUMP top flange case

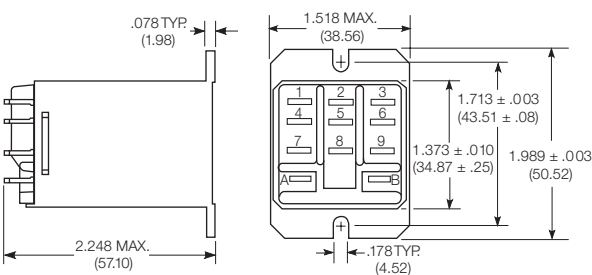

† Dimensions with .250" (6.35mm) terminals.
‡ Dimensions with .187" (4.75mm and .205" 5.21mm) terminals.

*Dimensions with .250" (6.35mm) terminals.
** Dimensions with .110" (2.79mm) or .205"(5.21mm) terminals.
*** Dimensions with .187" (4.75mm) terminals.

KUMP bracket mount case

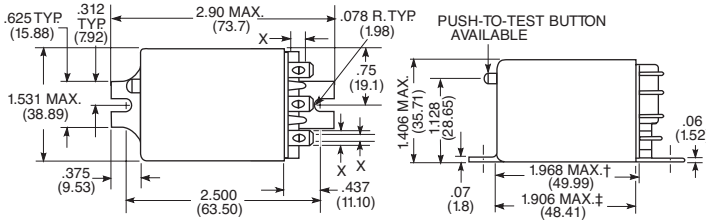

KUMP stud on end case

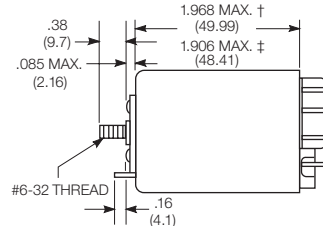

KUMP Series Panel Plug-in Relay (Continued)

Relay front diagrams

Models with 6.35mm (.250) QC terminals

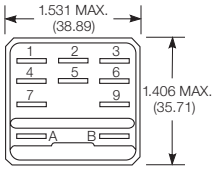

Models with all other terminals

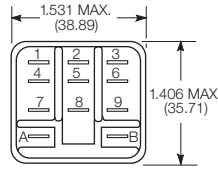

Terminal dimensions

4.75mm (.187) quick connect

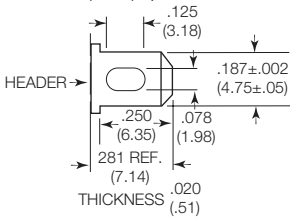

5.21mm (.205) quick connect

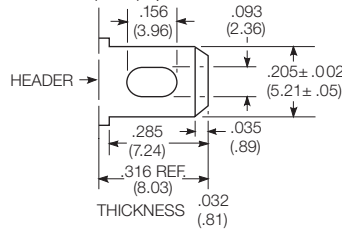

1.19mm (.047) printed circuit

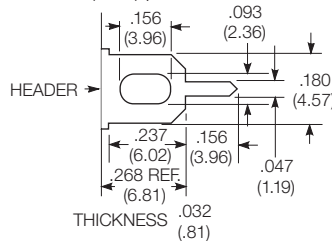

6.35mm (.250) quick connect

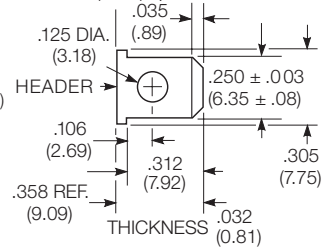

Terminal assignment

1 form Z
1 form X (delete 1 & 3)
1 form Y (delete 4 & 6)

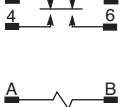

1 form C
1 form A (delete 2)
1 form B (delete 5)

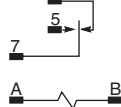

2 form C
2 form A (delete 1 & 3)
2 form B (delete 4 & 6)

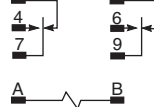

3 form C
3 form A (delete 1, 2 & 3)
3 form B (delete 4, 5 & 6)

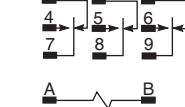

PCB layout

Bottom view on solder pins

1 form Z version
(Omit unnecessary holes for form X and Y types)

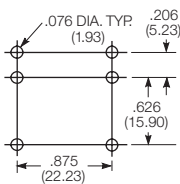

3 pole version
(Omit unnecessary holes for form A and 2 pole types)

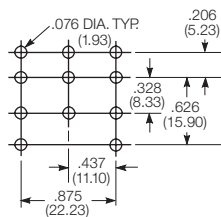

KUMP Series Panel Plug-in Relay (Continued)

Product code structure		Typical product code KUMP -11 A 1 8 -120				
Type						
KUM 15A open style relay						
KUMP 15A enclosed relay						
Contact arrangement						
1 1 form A (1 NO)	2 1 form B (1 NC)	3 1 form X (1 NO-DM)				
4 1 form Y (1 NC-DB)	5 1 form C (1 CO)	6 1 form Z (1 CO-DB-DM)				
7 2 form A (2 NO)	8 2 form B (2 NC)	11 2 form C (2 CO)				
12 3 form A (3 NO)	13 3 form B (3 NC)	14 3 form C (3 CO)				
Coil Input						
A AC, 50/60Hz	D DC					
Mounting and options						
KUM						
1 #6-32 mounting stud, 5.54mm (.218in) locating tab	2 2-hole bracket, #6-32 tapped					
3 #6-32 tapped core, 3.18mm (.125in) locating tab	4 #6-32 tapped core, 5.54mm (.218in) locating tab					
5 #6-32 tapped core, no locating tab						
KUMP						
1 Socket mount (plain) case						
2 Socket mount (plain) case with push-to-test button						
3 Socket mount (plain) case with indicator lamp ¹⁾						
4 Socket mount (plain) case with indicator lamp and push-to-test button ¹⁾						
5 Bracket mount case						
6 Bracket mount case with push-to-test button						
7 Bracket mount case with indicator lamp ¹⁾						
8 Bracket mount case with indicator lamp and push-to-test button ¹⁾						
9 Plain case with #6-32 stud and locating tab on end of case						
A Plain case with #6-32 stud and locating tab						
B Plain case with #6-32 stud and locating tab, push-to-test button						
C Plain case with #6-32 stud and locating tab, indicator lamp ¹⁾						
D Plain case with #6-32 stud and locating tab, push-to-test button and indicator lamp ¹⁾						
E Plain case with #6-32 tapped core and locating tab						
F Plain case with #6-32 tapped core and locating tab, push-to-test button						
G Plain case with #6-32 tapped core and locating tab, indicator lamp ¹⁾						
H Plain case with #6-32 tapped core and locating tab, push-to-test button and indicator lamp ¹⁾						
T Top flange case						
1) Indicator lamps are available on models with the following coils: 6-24VAC and VDC, 110VDC and 120-240VAC. Only models with 120-240VAC coils are UL recognized.						
Terminal and contact material						
6 5.21mm (.205in) quick connect/solder; AgCdO	8 4.75mm (.187in) quick connect/solder; AgCdO					
9 1.19mm (.047in) PCB, AgCdO	G 6.35mm (.250in) quick connect/solder; AgCdO ²⁾					
R 5.21mm (.205in) quick connect/solder; AgSnOInO	T 4.75mm (.187in) quick connect/solder; AgSnOInO					
U 1.19mm (.047in) PCB, AgSnOInO	V 6.35mm (.250in) quick connect/solder; AgSnOInO ²⁾					
²⁾ 6.35mm (.250in) quick connect/solder terminals are not available on 3 pole relays						
Coil voltage						
Coil code: please refer to coil versions table						

Product Code	Arrangement	Material	Coil	Terminals	Mounting	Part Number
KUMP-11A18-24	2 form C; 2 CO	AgCdO	24 VAC	4.75mm (.187in) QC	Socket mount, plain case	6-1393116-3
KUMP-11A18-120			120 VAC			6-1393116-2
KUMP-11A18-240			240 VAC			6-1393116-4
KUMP-11D18-12			12 VDC			7-1393116-1
KUMP-11D18-24			24 VDC			7-1393116-2
KUMP-11D18-110			110 VDC			7-1393116-0
KUMP-14A18-24	3 form C, 3 CO		24 VAC			8-1393116-5
KUMP-14A18-120			120 VAC			8-1393116-4
KUMP-14D18-12			12 VDC			9-1393116-0
KUMP-14D18-24			24 VDC			9-1393116-1

Компания «Океан Электроники» предлагает заключение долгосрочных отношений при поставках импортных электронных компонентов на взаимовыгодных условиях!

Наши преимущества:

- Поставка оригинальных импортных электронных компонентов напрямую с производств Америки, Европы и Азии, а так же с крупнейших складов мира;
- Широкая линейка поставок активных и пассивных импортных электронных компонентов (более 30 млн. наименований);
- Поставка сложных, дефицитных, либо снятых с производства позиций;
- Оперативные сроки поставки под заказ (от 5 рабочих дней);
- Экспресс доставка в любую точку России;
- Помощь Конструкторского Отдела и консультации квалифицированных инженеров;
- Техническая поддержка проекта, помощь в подборе аналогов, поставка прототипов;
- Поставка электронных компонентов под контролем ВП;
- Система менеджмента качества сертифицирована по Международному стандарту ISO 9001;
- При необходимости вся продукция военного и аэрокосмического назначения проходит испытания и сертификацию в лаборатории (по согласованию с заказчиком);
- Поставка специализированных компонентов военного и аэрокосмического уровня качества (Xilinx, Altera, Analog Devices, Intersil, Interpoint, Microsemi, Actel, Aeroflex, Peregrine, VPT, Syfer, Eurofarad, Texas Instruments, MS Kennedy, Miteq, Cobham, E2V, MA-COM, Hittite, Mini-Circuits, General Dynamics и др.);

Компания «Океан Электроники» является официальным дистрибьютором и эксклюзивным представителем в России одного из крупнейших производителей разъемов военного и аэрокосмического назначения «JONHON», а так же официальным дистрибьютором и эксклюзивным представителем в России производителя высокотехнологичных и надежных решений для передачи СВЧ сигналов «FORSTAR».



JONHON

«JONHON» (основан в 1970 г.)

Разъемы специального, военного и аэрокосмического назначения:

(Применяются в военной, авиационной, аэрокосмической, морской, железнодорожной, горно- и нефтедобывающей отраслях промышленности)

«FORSTAR» (основан в 1998 г.)

ВЧ соединители, коаксиальные кабели,
кабельные сборки и микроволновые компоненты:

(Применяются в телекоммуникациях гражданского и специального назначения, в средствах связи, РЛС, а так же военной, авиационной и аэрокосмической отраслях промышленности).



Телефон: 8 (812) 309-75-97 (многоканальный)

Факс: 8 (812) 320-03-32

Электронная почта: ocean@oceanchips.ru

Web: <http://oceanchips.ru/>

Адрес: 198099, г. Санкт-Петербург, ул. Калинина, д. 2, корп. 4, лит. А