

## Trench gate field-stop IGBT, M series 650 V, 120 A low loss in a Max247 long leads package

Datasheet - production data

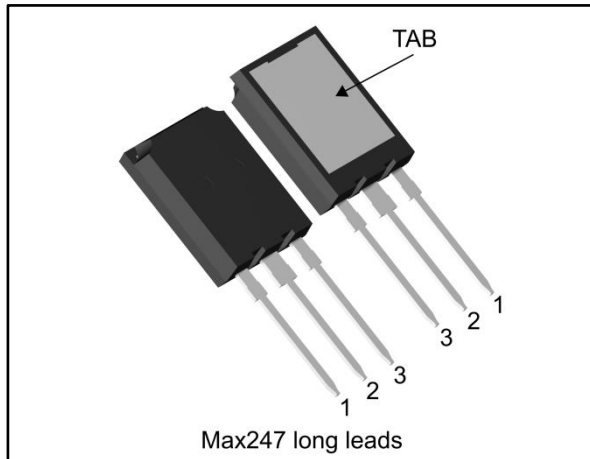
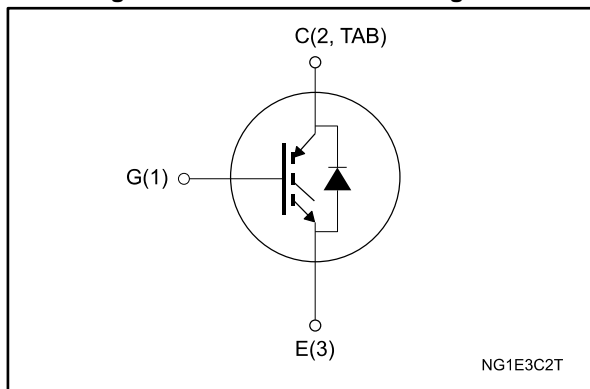

Figure 1: Internal schematic diagram



### Features

- 6  $\mu$ s of short-circuit withstand time
- $V_{CE(sat)} = 1.65$  V (typ.) @  $I_c = 120$  A
- Tight parameter distribution
- Safer paralleling
- Positive  $V_{CE(sat)}$  temperature coefficient
- Low thermal resistance
- Soft and very fast recovery antiparallel diode
- Maximum junction temperature:  $T_J = 175$  °C

### Applications

- Motor control
- UPS
- PFC
- General purpose inverter

### Description

This device is an IGBT developed using an advanced proprietary trench gate field-stop structure. The device is part of the M series IGBTs, which represent an optimal balance between inverter system performance and efficiency where low-loss and short-circuit functionality are essential. Furthermore, the positive  $V_{CE(sat)}$  temperature coefficient and tight parameter distribution result in safer paralleling operation.

Table 1: Device summary

Order code	Marking	Package	Packing
STGYA120M65DF2	G120M65DF2	Max247 long leads	Tube

---

## Contents

<b>1</b>	<b>Electrical ratings .....</b>	<b>3</b>
<b>2</b>	<b>Electrical characteristics .....</b>	<b>4</b>
	2.1 Electrical characteristics (curves) .....	6
<b>3</b>	<b>Test circuits .....</b>	<b>12</b>
<b>4</b>	<b>Package information .....</b>	<b>13</b>
	4.1 Max247 long leads package information .....	14
<b>5</b>	<b>Revision history .....</b>	<b>16</b>

# 1 Electrical ratings

**Table 2: Absolute maximum ratings**

Symbol	Parameter	Value	Unit
$V_{CES}$	Collector-emitter voltage ( $V_{GE} = 0$ V)	650	V
$I_C^{(1)}$	Continuous collector current at $T_C = 25$ °C	160	A
$I_C$	Continuous collector current at $T_C = 100$ °C	120	
$I_{CP}^{(2)}$	Pulsed collector current	360	A
$V_{GE}$	Gate-emitter voltage	$\pm 20$	V
$I_F^{(1)}$	Continuous forward current at $T_C = 25$ °C	160	A
$I_F$	Continuous forward current at $T_C = 100$ °C	120	
$I_{FP}^{(2)}$	Pulsed forward current	360	A
$P_{TOT}$	Total dissipation at $T_C = 25$ °C	625	W
$T_{STG}$	Storage temperature range	- 55 to 150	°C
$T_J$	Operating junction temperature range	- 55 to 175	

**Notes:**

(1)Current level is limited by bond wires.

(2)Pulse width limited by maximum junction temperature.

**Table 3: Thermal data**

Symbol	Parameter	Value	Unit
$R_{thJC}$	Thermal resistance junction-case IGBT	0.24	°C/W
$R_{thJC}$	Thermal resistance junction-case diode	0.6	
$R_{thJA}$	Thermal resistance junction-ambient	50	

## 2 Electrical characteristics

$T_C = 25\text{ °C}$  unless otherwise specified

**Table 4: Static characteristics**

Symbol	Parameter	Test conditions	Min.	Typ.	Max.	Unit
$V_{(BR)CES}$	Collector-emitter breakdown voltage	$V_{GE} = 0\text{ V}$ , $I_C = 250\text{ }\mu\text{A}$	650			V
$V_{CE(sat)}$	Collector-emitter saturation voltage	$V_{GE} = 15\text{ V}$ , $I_C = 120\text{ A}$		1.65	2.15	V
		$V_{GE} = 15\text{ V}$ , $I_C = 120\text{ A}$ , $T_J = 125\text{ °C}$		1.95		
		$V_{GE} = 15\text{ V}$ , $I_C = 120\text{ A}$ , $T_J = 175\text{ °C}$		2.1		
$V_F$	Forward on-voltage	$I_F = 120\text{ A}$		1.9	2.6	V
		$I_F = 120\text{ A}$ , $T_J = 125\text{ °C}$		1.7		
		$I_F = 120\text{ A}$ , $T_J = 175\text{ °C}$		1.6		
$V_{GE(th)}$	Gate threshold voltage	$V_{CE} = V_{GE}$ , $I_C = 2\text{ mA}$	5	6	7	V
$I_{CES}$	Collector cut-off current	$V_{GE} = 0\text{ V}$ , $V_{CE} = 650\text{ V}$			100	$\mu\text{A}$
$I_{GES}$	Gate-emitter leakage current	$V_{CE} = 0\text{ V}$ , $V_{GE} = \pm 20\text{ V}$			$\pm 250$	$\mu\text{A}$

**Table 5: Dynamic characteristics**

Symbol	Parameter	Test conditions	Min.	Typ.	Max.	Unit
$C_{ies}$	Input capacitance	$V_{CE} = 25\text{ V}$ , $f = 1\text{ MHz}$ , $V_{GE} = 0\text{ V}$	-	11	-	nF
$C_{oes}$	Output capacitance		-	0.61	-	
$C_{res}$	Reverse transfer capacitance		-	0.25	-	
$Q_g$	Total gate charge	$V_{CC} = 520\text{ V}$ , $I_C = 120\text{ A}$ , $V_{GE} = 0\text{ to }15\text{ V}$ (see <a href="#">Figure 30: "Gate charge test circuit"</a> )	-	420	-	nC
$Q_{ge}$	Gate-emitter charge		-	90	-	
$Q_{gc}$	Gate-collector charge		-	160	-	

Table 6: IGBT switching characteristics (inductive load)

Symbol	Parameter	Test conditions	Min.	Typ.	Max.	Unit
$t_{d(on)}$	Turn-on delay time	$V_{CE} = 400\text{ V}$ , $I_C = 120\text{ A}$ , $V_{GE} = 15\text{ V}$ , $R_G = 4.7\ \Omega$ (see <a href="#">Figure 29: "Test circuit for inductive load switching"</a> )		66	-	ns
$t_r$	Current rise time			38	-	ns
$(di/dt)_{on}$	Turn-on current slope			2500	-	A/ $\mu$ s
$t_{d(off)}$	Turn-off-delay time			185	-	ns
$t_f$	Current fall time			85	-	ns
$E_{on}^{(1)}$	Turn-on switching energy			1.8	-	mJ
$E_{off}^{(2)}$	Turn-off switching energy			4.41	-	mJ
$E_{ts}$	Total switching energy			6.21	-	mJ
$t_{d(on)}$	Turn-on delay time	$V_{CE} = 400\text{ V}$ , $I_C = 120\text{ A}$ , $V_{GE} = 15\text{ V}$ , $R_G = 4.7\ \Omega$ $T_J = 175\text{ }^\circ\text{C}$ (see <a href="#">Figure 29: "Test circuit for inductive load switching"</a> )		62	-	ns
$t_r$	Current rise time			48	-	ns
$(di/dt)_{on}$	Turn-on current slope			2016	-	A/ $\mu$ s
$t_{d(off)}$	Turn-off-delay time			187	-	ns
$t_f$	Current fall time			164	-	ns
$E_{on}^{(1)}$	Turn-on switching energy			4.4	-	mJ
$E_{off}^{(2)}$	Turn-off switching energy			6.0	-	mJ
$E_{ts}$	Total switching energy			10.4	-	mJ
$t_{sc}$	Short-circuit withstand time	$V_{CC} \leq 400\text{ V}$ , $V_{GE} = 13\text{ V}$ , $T_{Jstart} = 150\text{ }^\circ\text{C}$	10		-	$\mu$ s
		$V_{CC} \leq 400\text{ V}$ , $V_{GE} = 15\text{ V}$ , $T_{Jstart} = 150\text{ }^\circ\text{C}$	6		-	

**Notes:**

(1)Including the reverse recovery of the diode.

(2)Including the tail of the collector current.

Table 7: Diode switching characteristics (inductive load)

Symbol	Parameter	Test conditions	Min.	Typ.	Max.	Unit
$t_{rr}$	Reverse recovery time	$I_F = 120\text{ A}$ , $V_R = 400\text{ V}$ , $V_{GE} = 15\text{ V}$ , $di/dt = 1000\text{ A}/\mu\text{s}$ (see <a href="#">Figure 29: "Test circuit for inductive load switching"</a> )	-	202	-	ns
$Q_{rr}$	Reverse recovery charge		-	2.9	-	$\mu$ C
$I_{rrm}$	Reverse recovery current		-	32.5	-	A
$dl_{rr}/dt$	Peak rate of fall of reverse recovery current during $t_b$		-	500	-	A/ $\mu$ s
$E_{rr}$	Reverse recovery energy		-	500	-	$\mu$ J
$t_{rr}$	Reverse recovery time	$I_F = 120\text{ A}$ , $V_R = 400\text{ V}$ , $V_{GE} = 15\text{ V}$ , $di/dt = 1000\text{ A}/\mu\text{s}$ , $T_J = 175\text{ }^\circ\text{C}$ (see <a href="#">Figure 29: "Test circuit for inductive load switching"</a> )	-	320	-	ns
$Q_{rr}$	Reverse recovery charge		-	11.2	-	$\mu$ C
$I_{rrm}$	Reverse recovery current		-	62	-	A
$dl_{rr}/dt$	Peak rate of fall of reverse recovery current during $t_b$		-	270	-	A/ $\mu$ s
$E_{rr}$	Reverse recovery energy		-	1710	-	$\mu$ J

## 2.1 Electrical characteristics (curves)

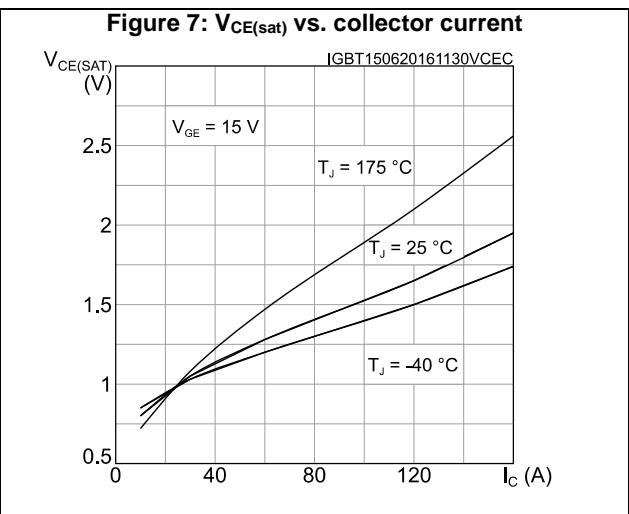
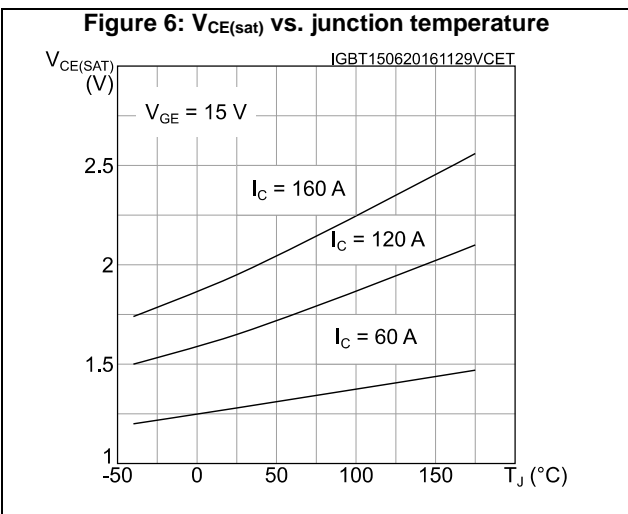
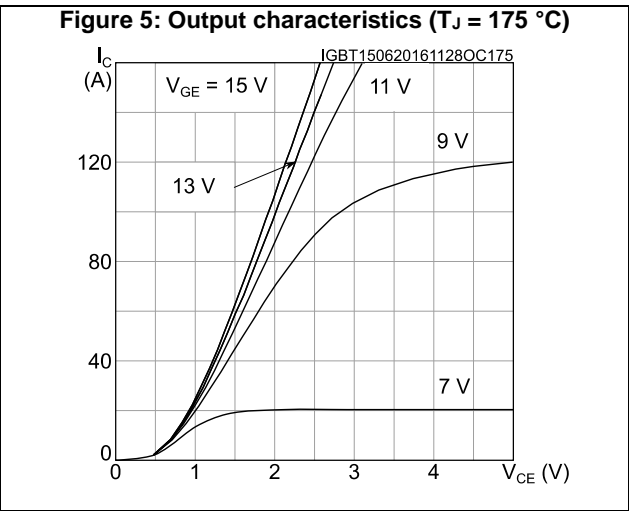
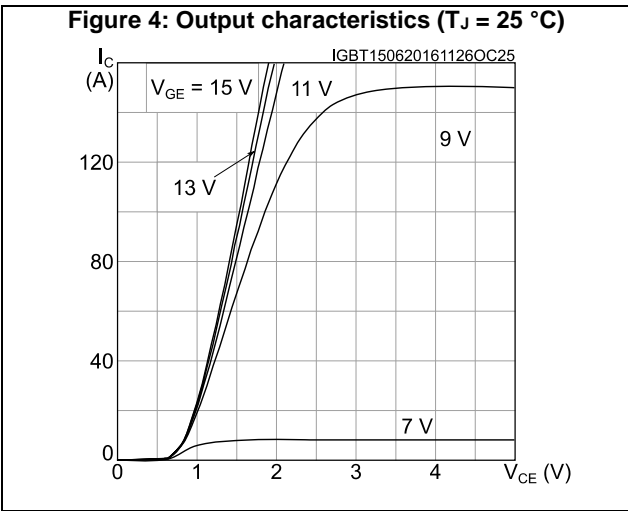
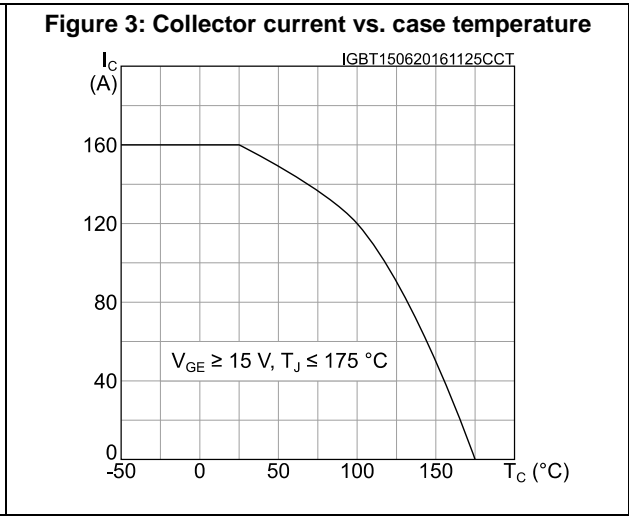
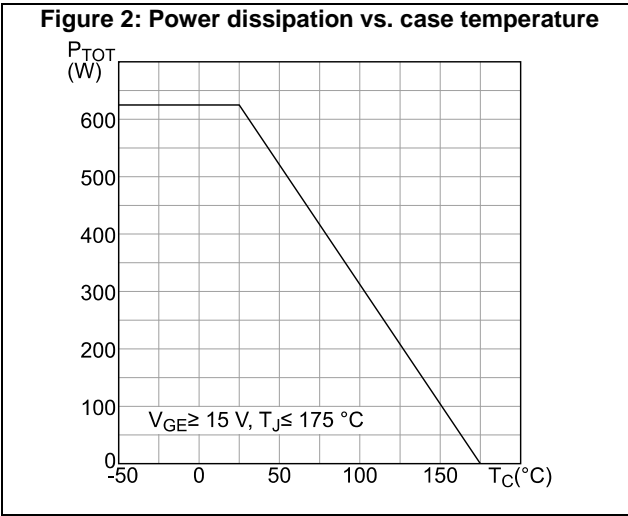

Figure 8: Collector current vs. switching frequency

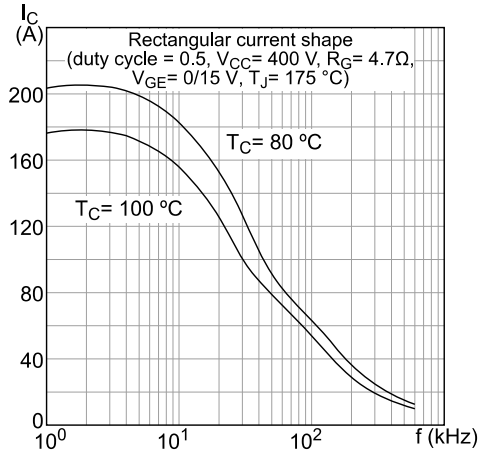

Figure 9: Forward bias safe operating area

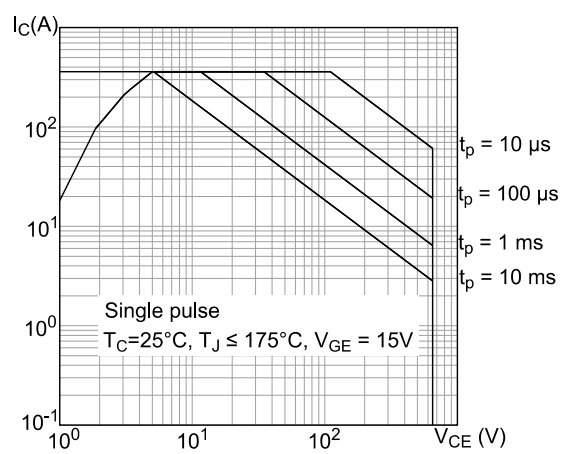

Figure 10: Transfer characteristics

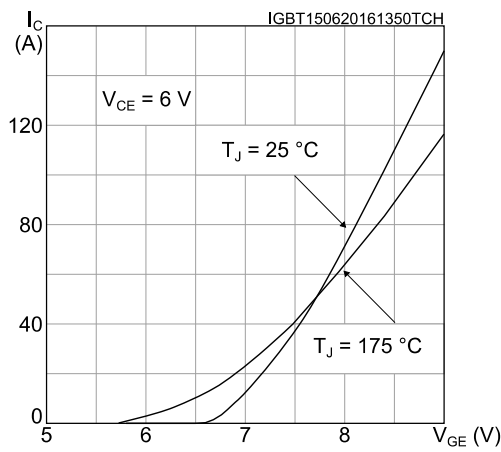

Figure 11: Diode V\_F vs. forward current

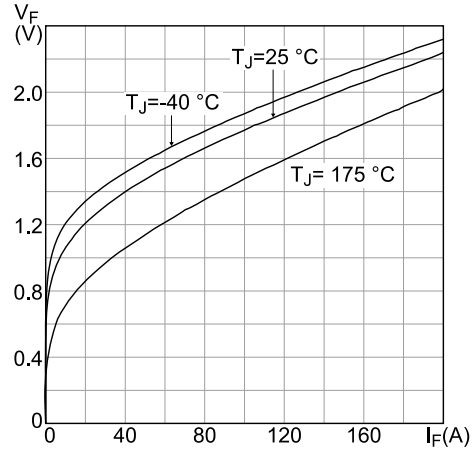

Figure 12: Normalized V\_{GE(th)} vs. junction temperature

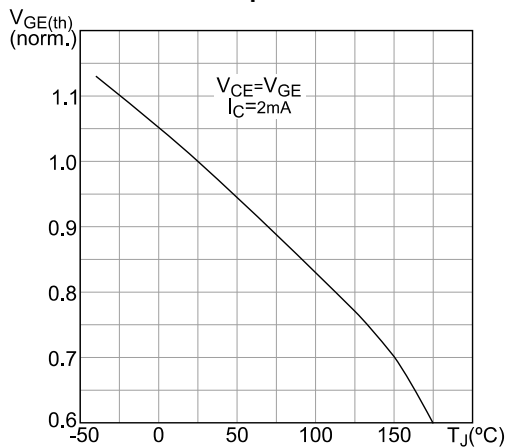
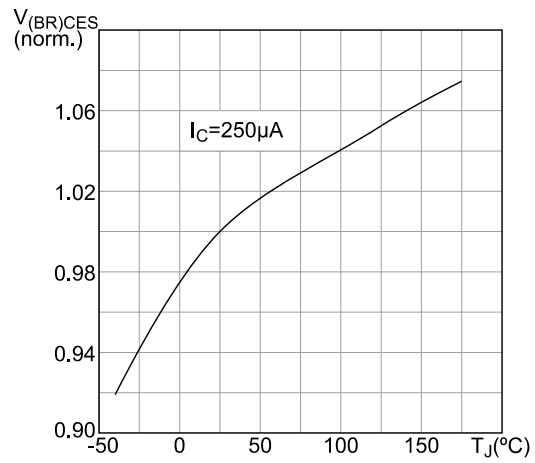
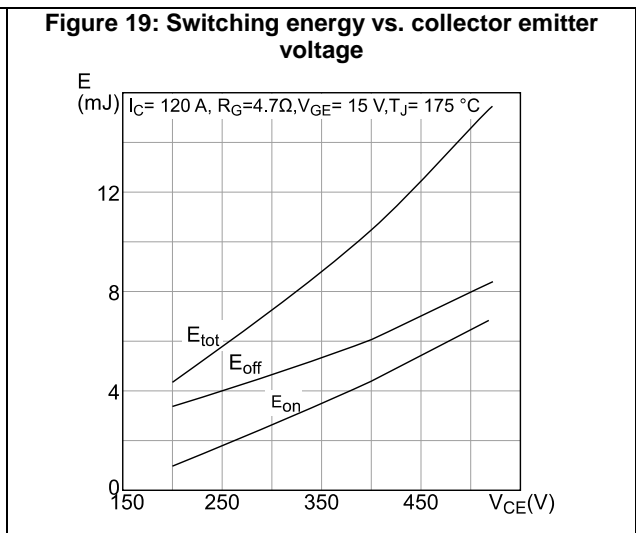
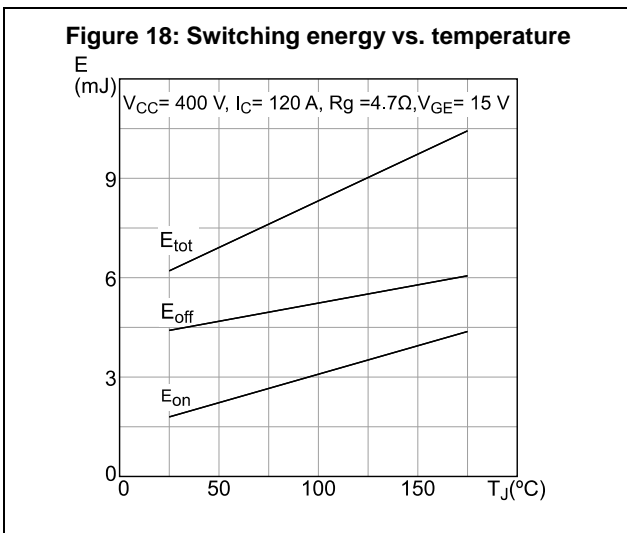
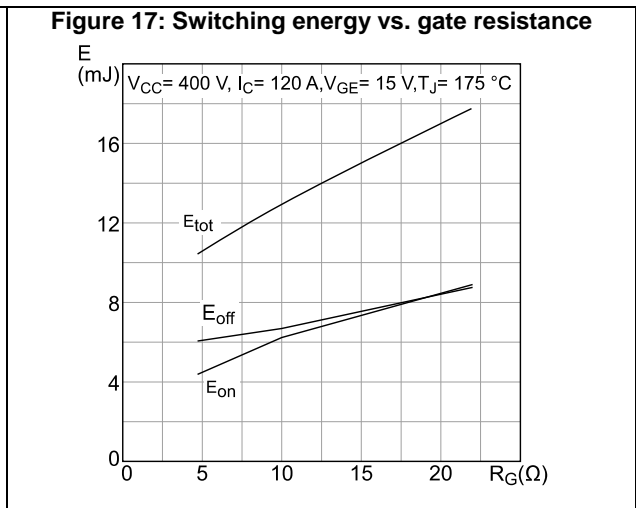
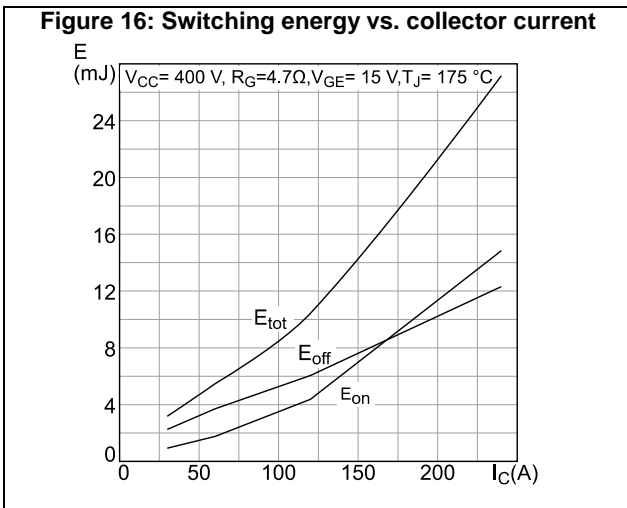
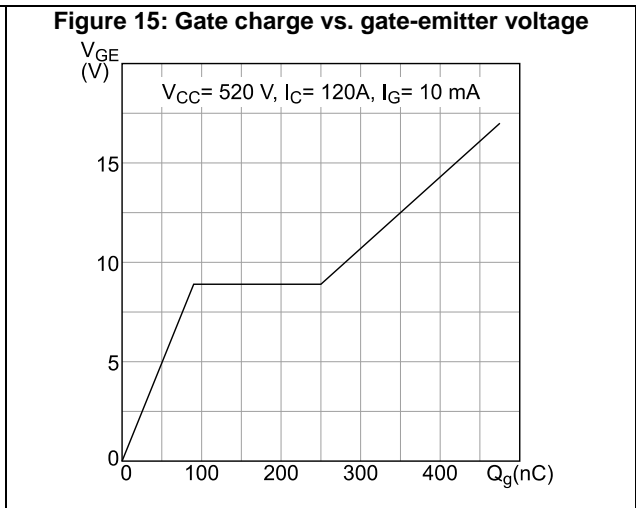
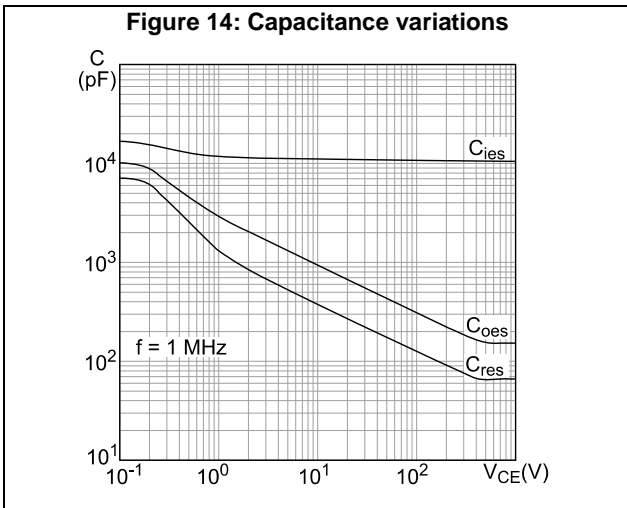

Figure 13: Normalized V\_{(BR)CES} vs. junction temperature







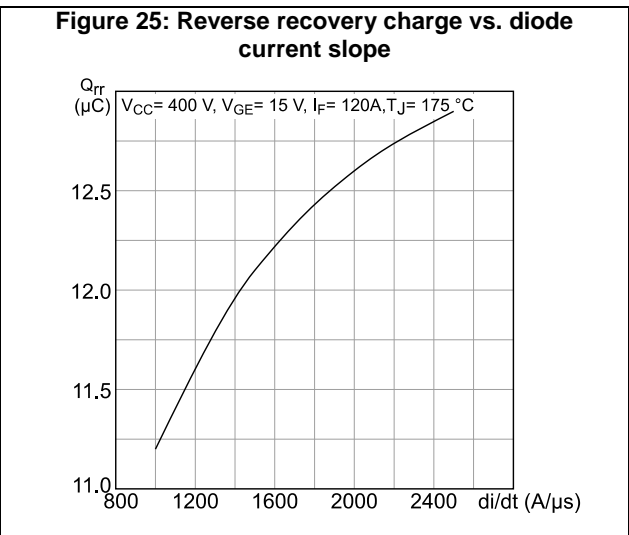
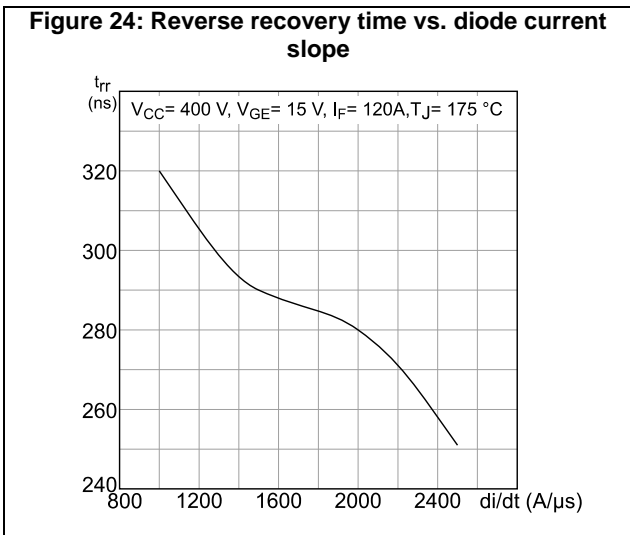
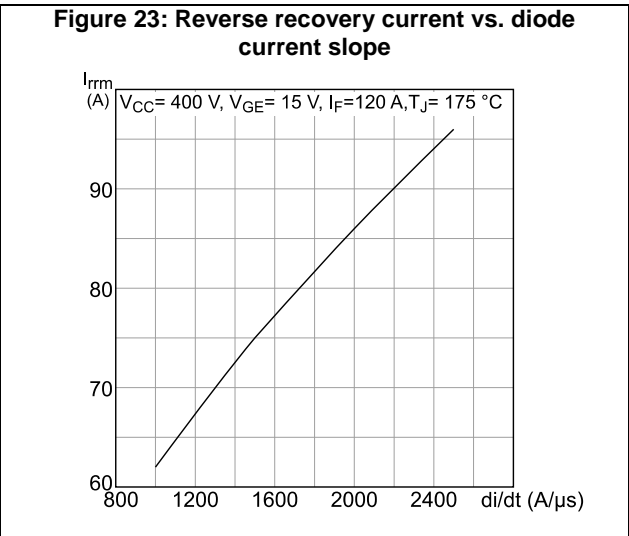
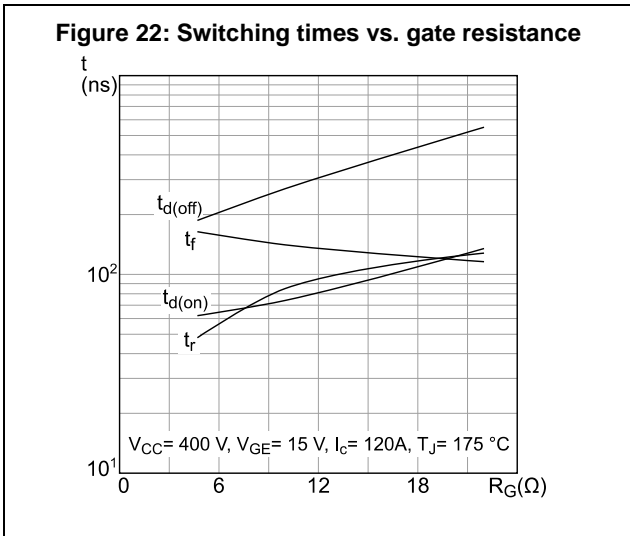
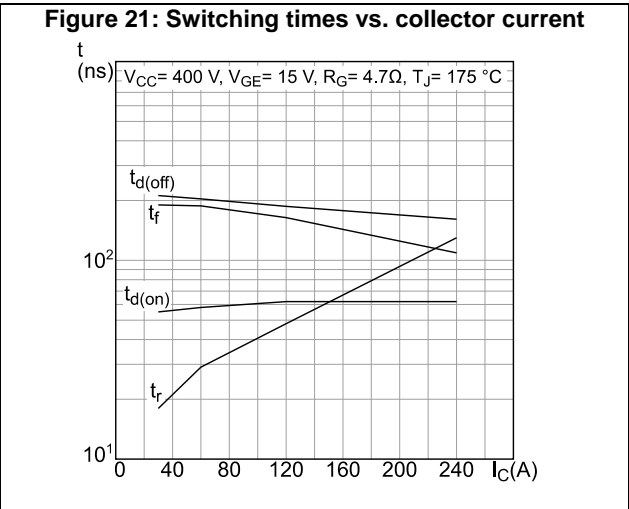
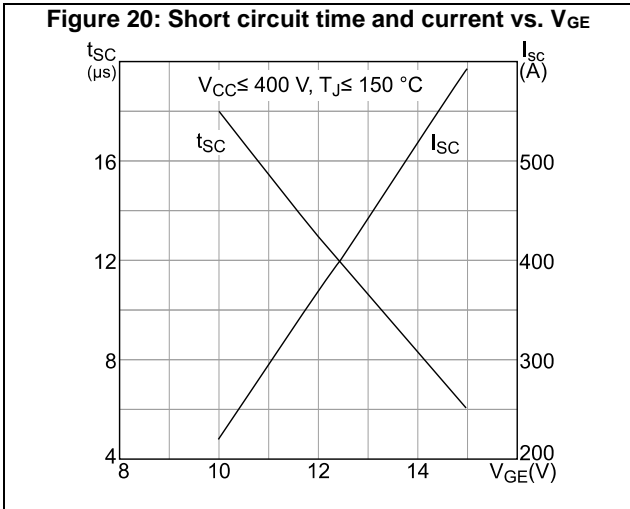
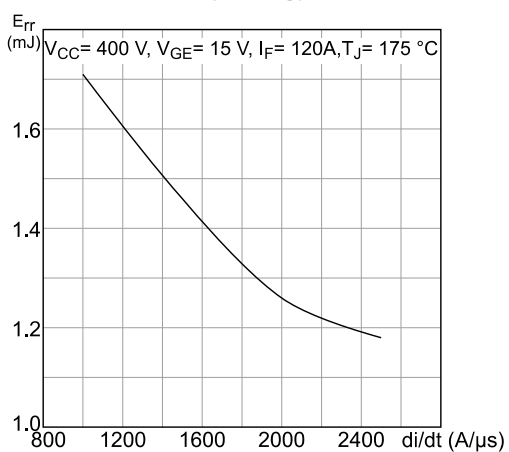
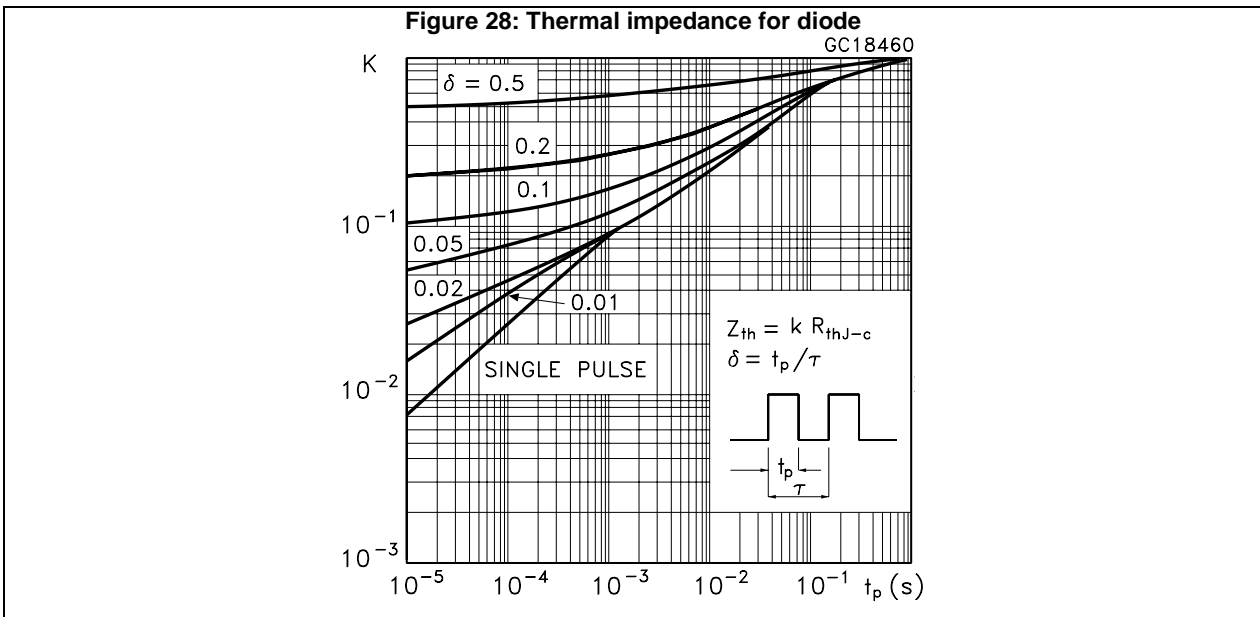
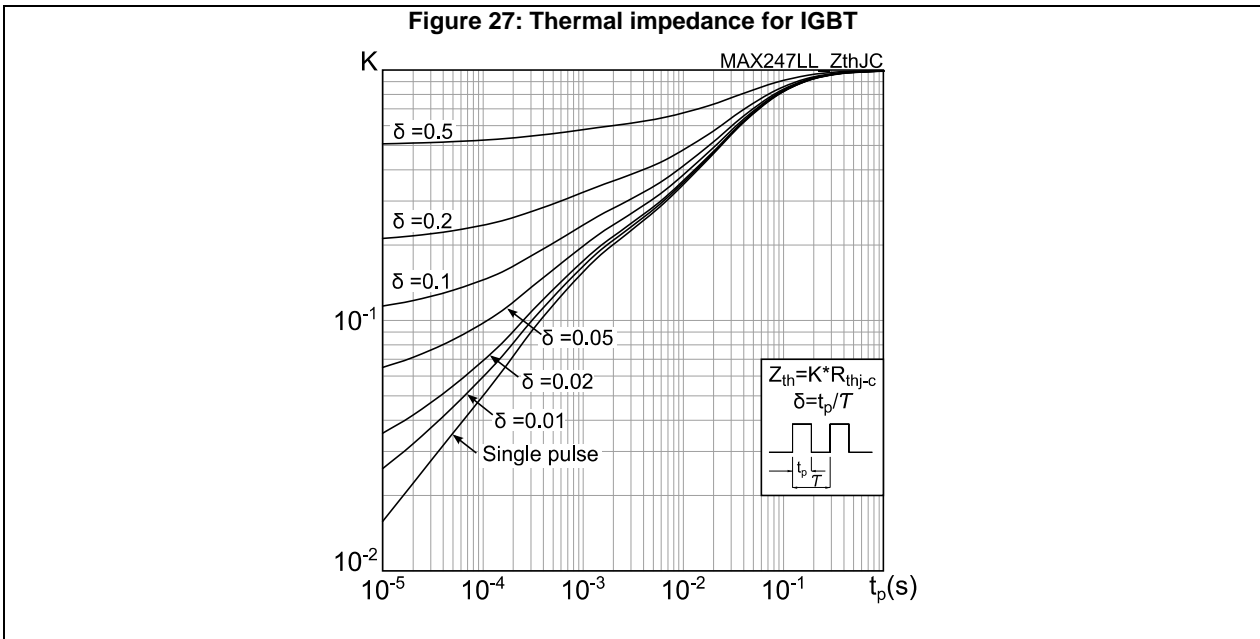

Figure 26: Reverse recovery energy vs. diode current slope





### 3 Test circuits

**Figure 29: Test circuit for inductive load switching**

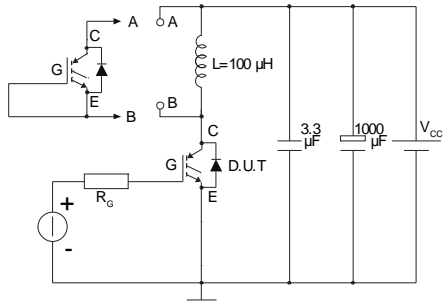

AM01504v1

**Figure 30: Gate charge test circuit**

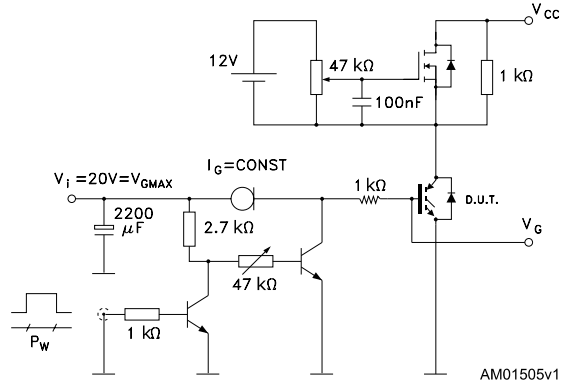

AM01505v1

**Figure 31: Switching waveform**

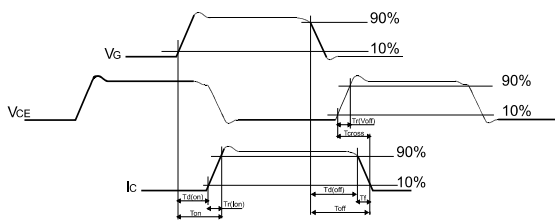

AM01506v1

**Figure 32: Diode reverse recovery waveform**

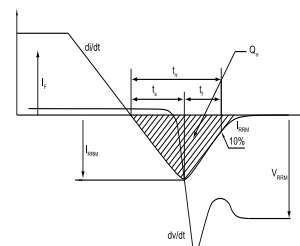

GADG180720171418SA

## 4 Package information

In order to meet environmental requirements, ST offers these devices in different grades of ECOPACK® packages, depending on their level of environmental compliance. ECOPACK® specifications, grade definitions and product status are available at: [www.st.com](http://www.st.com). ECOPACK® is an ST trademark.

### 4.1 Max247 long leads package information

Figure 33: Max247 long leads package outline

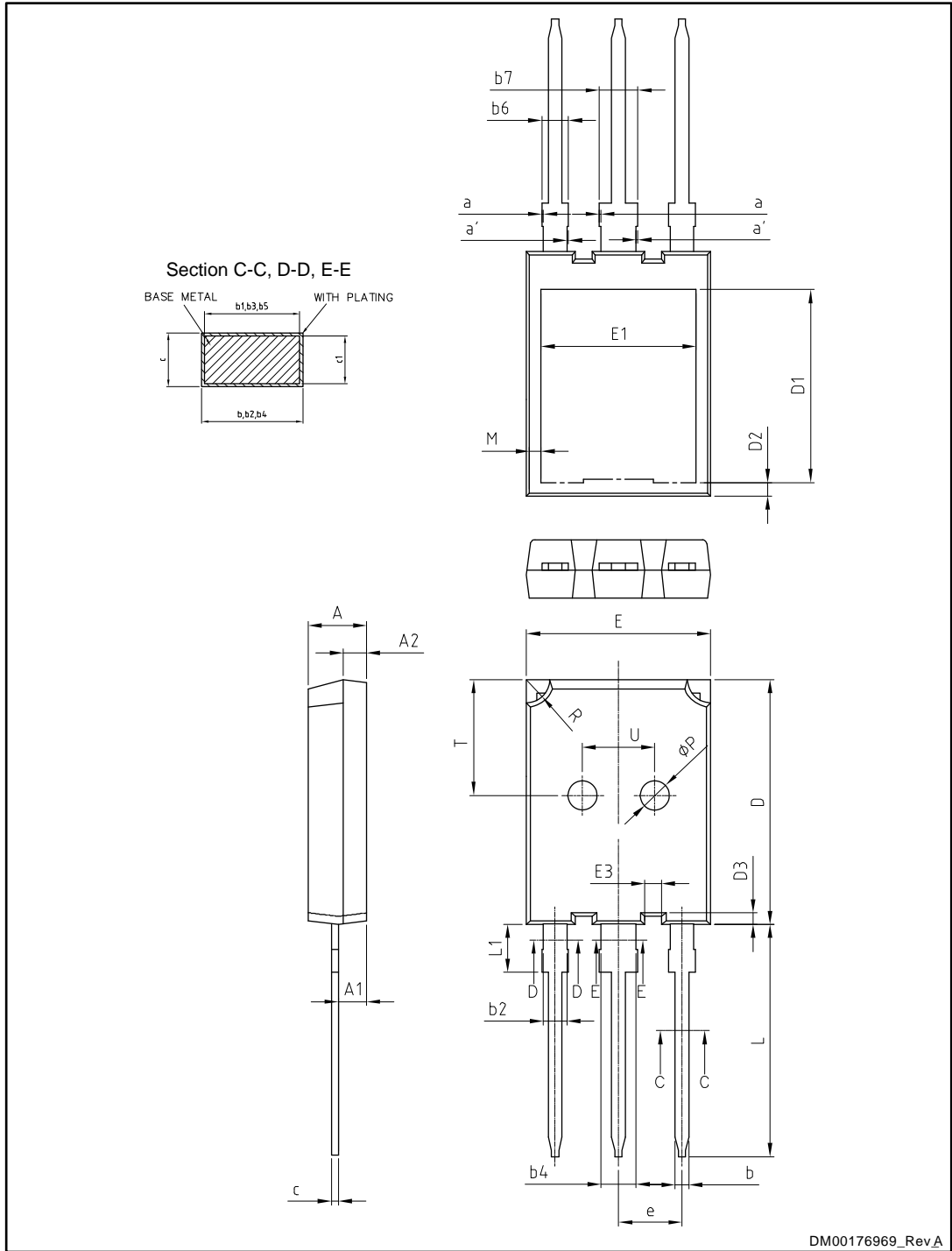

Table 8: Max247 long leads package mechanical data

Dim.	mm		
	Min.	Typ.	Max.
A	4.90	5.00	5.10
A1	2.31	2.41	2.51
A2	1.90	2.00	2.10
a	0		0.15
a'	0		0.15
b	1.16		1.26
b1	1.15	1.20	1.22
b2	1.96		2.06
b3	1.95	2.00	2.02
b4	2.96		3.06
b5	2.95	3.00	3.02
b6			2.25
b7			3.25
c	0.59		0.66
c1	0.58	0.60	0.62
D	20.90	21.00	21.10
D1	16.25	16.55	16.85
D2	1.05	1.17	1.35
D3	0.75	1.00	1.25
E	15.70	15.80	15.90
E1	13.10	13.26	13.50
E3	1.35	1.45	1.55
e	5.34	5.44	5.54
L	19.80	19.92	20.10
L1			4.30
M	0.70		1.30
P	2.40	2.50	2.60
R	1.90	2.00	2.10
T	9.80		10.20
U	6.00		6.40

## 5 Revision history

**Table 9: Document revision history**

Date	Revision	Changes
06-Apr-2016	1	First release.
10-May-2016	2	Document status promoted to production data. Added Section 2.1: "Electrical characteristics (curves)"
15-Jun-2016	3	Updated Figure 1: "Internal schematic diagram" and Table 2: "Absolute maximum ratings". Updated Section 2.1: "Electrical characteristics (curves)". Minor text changes.
12-Aug-2016	4	Updated <i>Table 7: "Diode switching characteristics (inductive load)"</i> and <i>Figure 25: Reverse recovery charge vs. diode current slope</i> . Minor text changes.
13-Sep-2017	5	Updated title, features and application in cover page. Updated <i>Figure 13: "Normalized <math>V(BR)_{CES}</math> vs. junction temperature"</i> . Minor text changes.



**IMPORTANT NOTICE – PLEASE READ CAREFULLY**

STMicroelectronics NV and its subsidiaries ("ST") reserve the right to make changes, corrections, enhancements, modifications, and improvements to ST products and/or to this document at any time without notice. Purchasers should obtain the latest relevant information on ST products before placing orders. ST products are sold pursuant to ST's terms and conditions of sale in place at the time of order acknowledgement.

Purchasers are solely responsible for the choice, selection, and use of ST products and ST assumes no liability for application assistance or the design of Purchasers' products.

No license, express or implied, to any intellectual property right is granted by ST herein.

Resale of ST products with provisions different from the information set forth herein shall void any warranty granted by ST for such product.

ST and the ST logo are trademarks of ST. All other product or service names are the property of their respective owners.

Information in this document supersedes and replaces information previously supplied in any prior versions of this document.

© 2017 STMicroelectronics – All rights reserved

Компания «Океан Электроники» предлагает заключение долгосрочных отношений при поставках импортных электронных компонентов на взаимовыгодных условиях!

Наши преимущества:

- Поставка оригинальных импортных электронных компонентов напрямую с производств Америки, Европы и Азии, а так же с крупнейших складов мира;
- Широкая линейка поставок активных и пассивных импортных электронных компонентов (более 30 млн. наименований);
- Поставка сложных, дефицитных, либо снятых с производства позиций;
- Оперативные сроки поставки под заказ (от 5 рабочих дней);
- Экспресс доставка в любую точку России;
- Помощь Конструкторского Отдела и консультации квалифицированных инженеров;
- Техническая поддержка проекта, помощь в подборе аналогов, поставка прототипов;
- Поставка электронных компонентов под контролем ВП;
- Система менеджмента качества сертифицирована по Международному стандарту ISO 9001;
- При необходимости вся продукция военного и аэрокосмического назначения проходит испытания и сертификацию в лаборатории (по согласованию с заказчиком);
- Поставка специализированных компонентов военного и аэрокосмического уровня качества (Xilinx, Altera, Analog Devices, Intersil, Interpoint, Microsemi, Actel, Aeroflex, Peregrine, VPT, Syfer, Eurofarad, Texas Instruments, MS Kennedy, Miteq, Cobham, E2V, MA-COM, Hittite, Mini-Circuits, General Dynamics и др.);

Компания «Океан Электроники» является официальным дистрибьютором и эксклюзивным представителем в России одного из крупнейших производителей разъемов военного и аэрокосмического назначения «JONHON», а так же официальным дистрибьютором и эксклюзивным представителем в России производителя высокотехнологичных и надежных решений для передачи СВЧ сигналов «FORSTAR».



## JONHON

«JONHON» (основан в 1970 г.)

Разъемы специального, военного и аэрокосмического назначения:

(Применяются в военной, авиационной, аэрокосмической, морской, железнодорожной, горно- и нефтедобывающей отраслях промышленности)

«FORSTAR» (основан в 1998 г.)

ВЧ соединители, коаксиальные кабели, кабельные сборки и микроволновые компоненты:

(Применяются в телекоммуникациях гражданского и специального назначения, в средствах связи, РЛС, а так же военной, авиационной и аэрокосмической отраслях промышленности).



Телефон: 8 (812) 309-75-97 (многоканальный)

Факс: 8 (812) 320-03-32

Электронная почта: [ocean@oceanchips.ru](mailto:ocean@oceanchips.ru)

Web: <http://oceanchips.ru/>

Адрес: 198099, г. Санкт-Петербург, ул. Калинина, д. 2, корп. 4, лит. А