

TMOV® and iTMOV® Varistor Series



Agency Approvals

| Agency | Agency Approval | Agency File Number |
|--------|--|--------------------|
| | UL 1449 | E320116 |
| | QC 42201-C001, QC42201-A001, IEC 60950-1 (Annex Q) | E1274/F |
| | IEC 61051-1, IEC 61051-2, IEC 60950-1 (Annex Q) | 40021525 |

Additional Information



**Datasheet
iTMOV**



**Datasheet
TMOV**



**Resources
iTMOV**



**Resources
TMOV**



**Samples
iTMOV**



**Samples
TMOV**

Description

The Littelfuse TMOV® and iTMOV® thermally protected varistors represent a new development in integrated circuit protection. Both versions are comprised of radial leaded MOVs (Metal Oxide Varistors) with an integrated thermally activated element designed to open in the event of overheating due to the abnormal overvoltage, limited current, conditions outlined in UL1449. The TMOV® and iTMOV® varistor's integrated thermal element, in conjunction with appropriate enclosure design, helps facilitate SPD module compliance to UL1449 for both cord connected and permanently connected applications.

The TMOV® and iTMOV® varistors offer quick thermal response due to the close proximity of the integrated thermal element to the MOV body. The integrated configuration also offers lower inductance than most discrete solutions resulting in improved clamping performance to fast overvoltage transients.

The iTMOV® varistor differs from the TMOV® varistor by the inclusion of a third lead for the purpose of indicating that the MOV has been disconnected from the circuit. This lead facilitates connection to monitoring circuitry.

Additionally TMOV® and iTMOV® varistors are wave solderable, thus simplifying end product assembly by reducing the the expense and rework associated with hand soldering operations.

Features

- RoHS compliant and Lead-free available
- -55°C to +85°C operating temp range
- Designed to facilitate compliance to UL1449 for SPD products
- Three-lead version available for indication purposes
- High peak surge current rating up to 10kA
- Wave solderable
- Standard lead form and spacing option

Applications

- SPD Products
- AC Panel Protection Modules
- AC Line Power Supplies
- Surge Protected Strip Connectors
- AC Power Meters
- Relocatable AC Power Taps
- GFCI (Ground Fault Current Interrupter)
- UPS (Uninterruptable Power Supply)
- White Goods
- Plug-in SPD
- Inverters
- AC/DC Power Supplies

Absolute Maximum Ratings

• For ratings of individual members of a series, see Device Ratings and Specifications chart

| Continuous | TMOV® and iTMOV® Varistor Series | Units |
|--|----------------------------------|-------|
| Steady State Applied Voltage: | | |
| AC Voltage Range ($V_{M(ACRMS)}$) | 115 to 750 | V |
| Transient: | | |
| Peak Pulse Current (I_{TM}) - For 8x20µs Current Wave, single pulse | 6,000 to 10,000 | A |
| Single-Pulse Energy Capability - For 2ms Current Wave | 35 to 480 | J |
| Operating Ambient Temperature Range (T_A) | -55 to +85 | °C |
| Storage Temperature Range (T_{STG}) | -55 to +125 | °C |
| Temperature Coefficient (α_V) of Clamping Voltage (V_C) at Specified Test Current | <0.01 | %/°C |
| Hi-Pot Encapsulation (COATING Isolation Voltage Capability) | 2,500 | V |
| Thermal Protection Isolation Voltage Capability (when operated) | 600 | V |
| COATING Insulation Resistance | 1,000 | MΩ |
| Indicator Lead Rating (Lead-3 - iTMOV® varistor only): | | |
| Continuous RMS current | 100 | mA |
| Surge Current, 8/20µs | 10,000 | A |

CAUTION: Stresses above those listed in "Absolute Maximum Ratings" may cause permanent damage to the device. This is a stress only rating and operation of the device at these or any other conditions above those indicated in the operational sections of this specification is not implied.

Ratings & Specifications

| TMOV® Varistor Lead-free And RoHS Compliant Models | | iTMOV® Varistor Lead-free and RoHS Compliant Models | | Disc Diameter | Maximum Rating (85°C) | | | | | Specifications (25°C) | | | | |
|--|----------|---|----------|------------------|-----------------------|-------------|-----------|----------------------------|----------------------------|---|--------------------|--|----------|------------------------------------|
| Part Number | Branding | Part Number | Branding | | Continuous | | Transient | | | Varistor Voltage at 1mA Test Current | | Maximum Clamping Voltage 8/20µs | | Typical Capacitance f = 1MHz |
| | | | | | $V_{M(ACRMS)}$ | $V_{M(DC)}$ | W_{TM} | $I_{TM} 1 \times$ Pulse | $I_{TM} 2 \times$ Pulse | $V_{N(DC)}$ Min | $V_{N(DC)}$ Max | V_C | I_{PK} | C |
| (mm) | (V) | (V) | (J) | (A) | (A) | (V) | (V) | (A) | (pF) | | | | | |
| TMOV14RP115E | P4T115E | TMOV14RP115M | P4T115M | 14 | 115 | 150 | 35 | 6000 | 4500 | 162 | 198 | 300 | 50 | 1100 |
| TMOV20RP115E | P2T115E | TMOV20RP115M | P2T115M | 20 | 115 | 150 | 52 | 10000 | 6500 | 162 | 198 | 300 | 100 | 2400 |
| TMOV14RP130E | P4T130E | TMOV14RP130M | P4T130M | 14 | 130 | 170 | 50 | 6000 | 4500 | 184.5 | 225.5 | 340 | 50 | 1000 |
| TMOV20RP130E | P2T130E | TMOV20RP130M | P2T130M | 20 | 130 | 170 | 100 | 10000 | 6500 | 184.5 | 225.5 | 340 | 100 | 1900 |
| TMOV14RP140E | P4T140E | TMOV14RP140M | P4T140M | 14 | 140 | 180 | 55 | 6000 | 4500 | 198 | 242 | 360 | 50 | 900 |
| TMOV20RP140E | P2T140E | TMOV20RP140M | P2T140M | 20 | 140 | 180 | 110 | 10000 | 6500 | 198 | 242 | 360 | 100 | 1750 |
| TMOV14RP150E | P4T150E | TMOV14RP150M | P4T150M | 14 | 150 | 200 | 60 | 6000 | 4500 | 216 | 264 | 395 | 50 | 800 |
| TMOV20RP150E | P2T150E | TMOV20RP150M | P2T150M | 20 | 150 | 200 | 120 | 10000 | 6500 | 216 | 264 | 395 | 100 | 1600 |
| TMOV14RP175E | P4T175E | TMOV14RP175M | P4T175M | 14 | 175 | 225 | 70 | 6000 | 4500 | 243 | 297 | 455 | 50 | 700 |
| TMOV20RP175E | P2T175E | TMOV20RP175M | P2T175M | 20 | 175 | 225 | 135 | 10000 | 6500 | 243 | 297 | 455 | 100 | 1400 |
| TMOV14RP200E | P4T200E | TMOV14RP200M | P4T200M | 14 | 200 | 260 | 75 | 6000 | 4500 | 283 | 345 | 530 | 50 | 630 |
| TMOV20RP200E | P2T200E | TMOV20RP200M | P2T200M | 20 | 200 | 260 | 154 | 10000 | 6500 | 283 | 345 | 530 | 100 | 1250 |
| TMOV14RP230E | P4T230E | TMOV14RP230M | P4T230M | 14 | 230 | 300 | 80 | 6000 | 4500 | 324 | 396 | 595 | 50 | 550 |
| TMOV20RP230E | P2T230E | TMOV20RP230M | P2T230M | 20 | 230 | 300 | 160 | 10000 | 6500 | 324 | 396 | 595 | 100 | 1100 |
| TMOV14RP250E | P4T250E | TMOV14RP250M | P4T250M | 14 | 250 | 320 | 100 | 6000 | 4500 | 351 | 429 | 650 | 50 | 500 |
| TMOV20RP250E | P2T250E | TMOV20RP250M | P2T250M | 20 | 250 | 320 | 170 | 10000 | 6500 | 351 | 429 | 650 | 100 | 1000 |
| TMOV14RP275E | P4T275E | TMOV14RP275M | P4T275M | 14 | 275 | 350 | 110 | 6000 | 4500 | 387 | 473 | 710 | 50 | 450 |
| TMOV20RP275E | P2T275E | TMOV20RP275M | P2T275M | 20 | 275 | 350 | 190 | 10000 | 6500 | 387 | 473 | 710 | 100 | 900 |
| TMOV14RP300E | P4T300E | TMOV14RP300M | P4T300M | 14 | 300 | 385 | 125 | 6000 | 4500 | 423 | 517 | 775 | 50 | 400 |
| TMOV20RP300E | P2T300E | TMOV20RP300M | P2T300M | 20 | 300 | 385 | 250 | 10000 | 6500 | 423 | 517 | 775 | 100 | 800 |
| TMOV14RP320E | P4T320E | TMOV14RP320M | P4T320M | 14 | 320 | 420 | 136 | 6000 | 4500 | 459 | 561 | 840 | 50 | 380 |
| TMOV20RP320E | P2T320E | TMOV20RP320M | P2T320M | 20 | 320 | 420 | 270 | 10000 | 6500 | 459 | 561 | 840 | 100 | 750 |
| TMOV14RP385E | P4T385E | TMOV14RP385M | P4T385M | 14 | 385 | 505 | 150 | 6000 | 4500 | 558 | 682 | 1025 | 50 | 360 |
| TMOV20RP385E | P2T385E | TMOV20RP385M | P2T385M | 20 | 385 | 505 | 300 | 10000 | 6500 | 558 | 682 | 1025 | 100 | 700 |
| TMOV14RP420E | P4T420E | TMOV14RP420M | P4T420M | 14 | 420 | 560 | 160 | 6000 | 4500 | 612 | 748 | 1120 | 50 | 300 |
| TMOV20RP420E | P2T420E | TMOV20RP420M | P2T420M | 20 | 420 | 560 | 320 | 10000 | 6500 | 612 | 748 | 1120 | 100 | 600 |
| TMOV14RP460E | P4T460E | TMOV14RP460M | P4T460M | 14 | 460 | 610 | 180 | 6000 | 4500 | 675 | 825 | 1240 | 50 | 220 |
| TMOV20RP460E | P2T460E | TMOV20RP460M | P2T460M | 20 | 460 | 610 | 360 | 10000 | 6500 | 675 | 825 | 1240 | 100 | 200 |
| TMOV14RP510E | P4T510E | TMOV14RP510M | P4T510M | 14 | 510 | 670 | 185 | 6000 | 4500 | 738 | 902 | 1355 | 50 | 200 |
| TMOV20RP510E | P2T510E | TMOV20RP510M | P2T510M | 20 | 510 | 670 | 325 | 10000 | 6500 | 738 | 902 | 1355 | 100 | 350 |
| TMOV14RP550E | P4T550E | TMOV14RP550M | P4T550M | 14 | 550 | 715 | 190 | 6000 | 4500 | 819 | 1001 | 1500 | 50 | 180 |
| TMOV20RP550E | P2T550E | TMOV20RP550M | P2T550M | 20 | 550 | 715 | 360 | 10000 | 6500 | 819 | 1001 | 1500 | 100 | 300 |

Ratings & Specifications

| TMOV [®] Varistor Lead-free And RoHS Compliant Models | | iTMOV [®] Varistor Lead-free and RoHS Compliant Models | | Disc Diameter | Maximum Rating (85°C) | | | | | Specifications (25°C) | | | | |
|--|----------|---|----------|------------------|-------------------------------|----------------------------|------------------------|------------------------------------|------------------------------------|--|----------------|---|------------------------|---|
| Part Number | Branding | Part Number | Branding | | Continuous | | Transient | | | Varistor Voltage at 1mA Test Current | | Maximum Clamping Voltage 8/20 μ s | | Typical Capaci- tance f = 1MHz |
| | | | | | AC Volts | DC Volts | Energy 2ms | Peak Surge Current 8/20 μ s | V _(NDCI) Min | V _(NDCI) Max | V _C | I _{PK} | C | |
| | | | | (mm) | V _(MACIRMS) (V) | V _(MDCI) (V) | W _{TM} (J) | I _{TM 1x} Pulse (A) | I _{TM 2x} Pulse (A) | V _(NDCI) (V) | | V _C (V) | I _{PK} (A) | C (pF) |
| TMOV14RP575E | P4T575E | TMOV14RP575M | P4T575M | 14 | 575 | 730 | 195 | 6000 | 4500 | 857 | 1047 | 1568 | 50 | 170 |
| TMOV20RP575E | P2T575E | TMOV20RP575M | P2T575M | 20 | 575 | 730 | 375 | 10000 | 6500 | 857 | 1047 | 1568 | 100 | 275 |
| TMOV14RP625E | P4T625E | TMOV14RP625M | P4T625M | 14 | 625 | 825 | 200 | 6000 | 4500 | 900 | 1100 | 1650 | 50 | 160 |
| TMOV20RP625E | P2T625E | TMOV20RP625M | P2T625M | 20 | 625 | 825 | 400 | 10000 | 6500 | 900 | 1100 | 1650 | 100 | 250 |
| TMOV14RP750E | P4T750E | TMOV14RP750M | P4T750M | 14 | 750 | 970 | 210 | 6000 | 4500 | 1080 | 1320 | 1980 | 50 | 140 |
| TMOV20RP750E | P2T750E | TMOV20RP750M | P2T750M | 20 | 750 | 970 | 480 | 10000 | 6500 | 1080 | 1320 | 1980 | 100 | 175 |

Thermal Characteristics

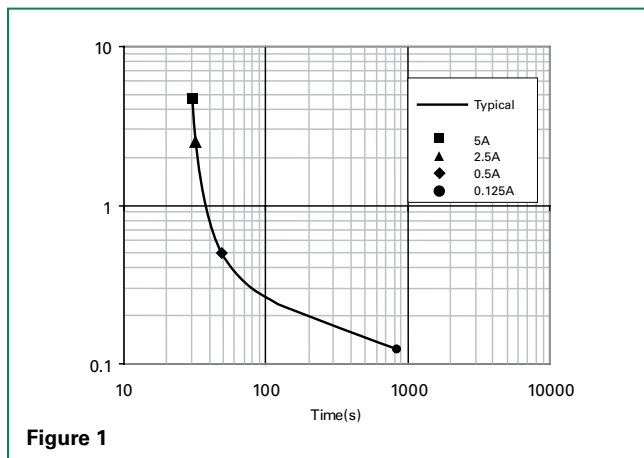

Figure 1

Note : The TMOV[®] and iTMOV[®] varistors are intended, in conjunction with appropriate enclosure design, to help facilitate SPD module compliance to UL 1449, 3rd Edition Section 39.4 (abnormal overvoltage limited current requirements). Under these extreme abnormal overvoltage conditions, some units will exhibit substantial heating, arcing and venting prior to opening. Modules should be designed to contain this possibility. Application testing is strongly recommended.

Maximum Clamping Voltage for 14mm Parts

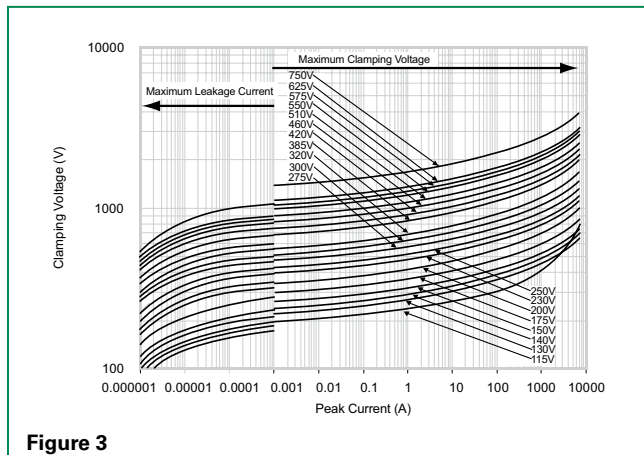

Figure 3

Maximum Clamping Voltage for 20mm Parts

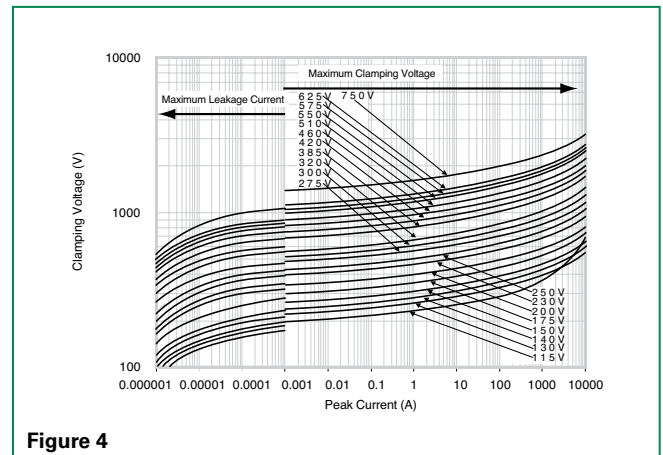

Figure 4

Repetitive Surge Capability for 14mm Parts



Figure 5

NOTE: Average power dissipation of transients should not exceed 0.6W

Repetitive Surge Capability for 20mm Parts

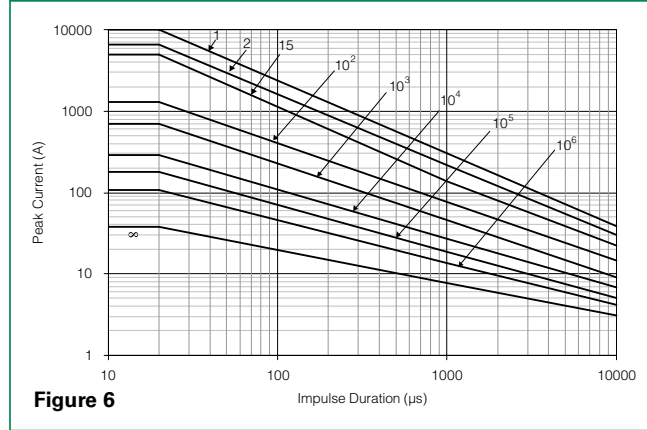

Figure 6

NOTE: Average power dissipation of transients should not exceed 1.0W

Wave Solder Profile

Because the TMOV® and iTMOV® varistors contain a thermal protection device, care must be taken when soldering the devices into place. Two soldering methods are possible. Firstly, hand soldering: It is recommended to heat-sink the leads of the device. Secondly, wave soldering: It is critically important that all preheat stage and the solder bath temperatures are rigidly controlled.

Non Lead-free Profile

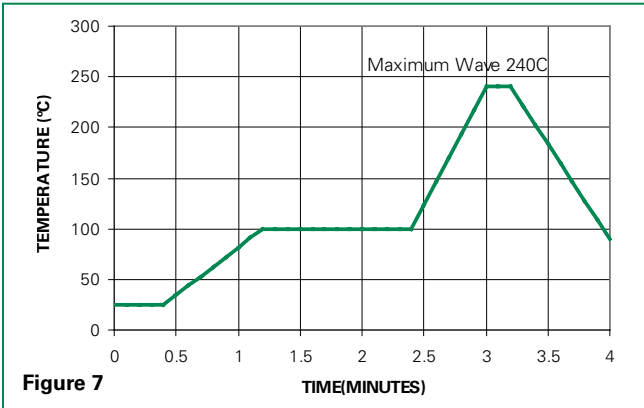

Figure 7

Lead-free Profile

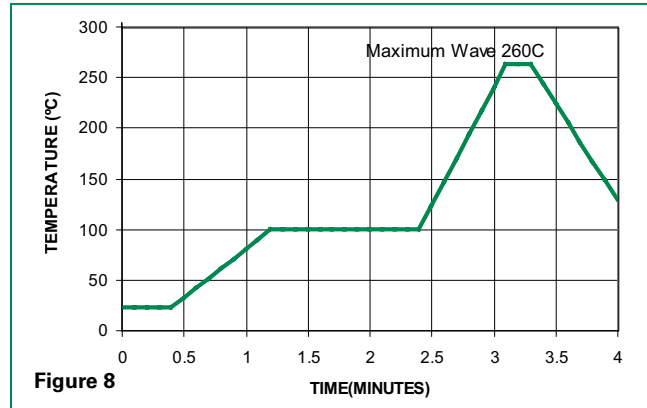

Figure 8

Physical Specifications

| | |
|----------------------------------|---|
| Lead Material | Copper clad steel wire |
| Soldering Characteristics | Solderability per MIL-STD-202, Method 208 |
| Insulating Material | Cured, flame retardant epoxy polymer meets UL94V-0 requirements |
| Device Labeling | Marked with LF, voltage, UL/CSA logos, and date code |

Environmental Specifications

| | |
|--------------------------------------|---|
| Operating/Storage Temperature | -55°C to +85°C |
| Humidity Aging | +85°C, 85% RH , 1000 hours +/-10% typical voltage change |
| Thermal Shock | +85°C to -55°C 5 times +/-10% typical voltage change |
| Solvent Resistance | MIL-STD-202, Method 215 |
| Moisture Sensitivity | Level 1, J-STD-020 |

Lead Configurations



Note: MOVs are non-polarized passive elements

iTMOV[®] Varistor Application Examples

The application examples below show how the indicator lead on the iTMOV[®] varistor can be used to indicate that the thermal element has been opened. This signifies that the circuit is no longer protected from transients by the MOV.

Application Example 1

In this case, the LED is normally on, and is off when the thermal element opens.



Application Example 2

This circuit utilizes an optocoupler to provide galvanic isolations between the iTMOV[®] varistor and the indicating or alarm circuitry.



Application Example 3

This circuit illustrates the use of the monitoring lead of the iTMOV[®] varistor to ensure that equipment is only operated when overvoltage protection present. In normal operation the load switch relay solenoid is powered via the indicator lead of the iTMOV[®] varistor. In the event of the thermal element being activated, the relay will de-activate, cutting power to the protected circuit and the fault LED will illuminate.



Please note: Indicator circuits are provided as a guideline only. Verification of actual indicator circuitry is the responsibility of the end user. Component values selected must be appropriate for the specific AC line voltage service and application.

Device Dimensions

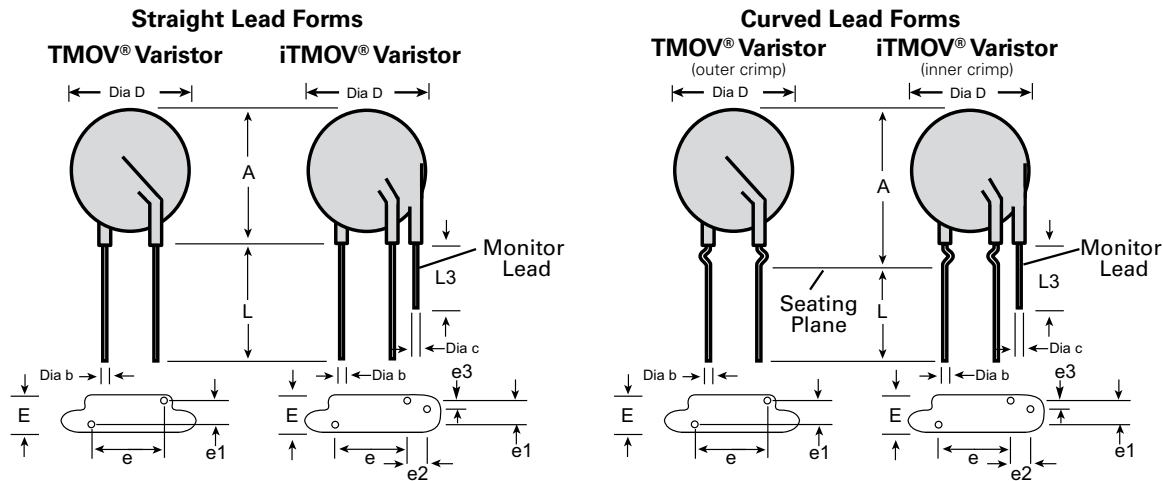

| Dimension | V _{RMS} Voltage Model | TMOV® Varistor | | | | iTMOV® Varistor | | | |
|---|--------------------------------|----------------|--------------|--------------|--------------|-----------------|--------------|--------------|--------------|
| | | 14mm Size | | 20mm Size | | 14mm Size | | 20mm Size | |
| | | Min. mm (in) | Max. mm (in) | Min. mm (in) | Max. mm (in) | Min. mm (in) | Max. mm (in) | Min. mm (in) | Max. mm (in) |
| A Straight Lead | ALL | 17.0 (0.669) | 22.0 (0.866) | 23.0 (0.906) | 28.0 (1.10) | 17.0 (0.669) | 22.0 (0.866) | 23.0 (0.906) | 28.0 (1.10) |
| A Crimped Lead | ALL | -- | 22.5 (0.886) | -- | 31.0 (1.221) | -- | 22.5 (0.886) | -- | 31.0 (1.221) |
| Dia D | ALL | 13.5 (0.531) | 17.0 (0.669) | 19.0 (0.748) | 23.0 (0.906) | 13.5 (0.531) | 17.0 (0.669) | 19.0 (0.748) | 23.0 (0.906) |
| e | ALL | 6.5 (0.256) | 8.5 (0.335) | 6.5 (0.256) | 8.5 (0.335) | 6.5 (0.256) | 8.5 (0.335) | 6.5 (0.256) | 8.5 (0.335) |
| e1 Bulk Pack | 115-175 | 1.5 (0.059) | 4.0 (0.157) | 1.5 (0.059) | 4.0 (0.157) | 1.5 (0.059) | 4.0 (0.157) | 1.5 (0.059) | 4.0 (0.157) |
| | 200-275 | 2.0 (0.079) | 4.5 (0.177) | 2.0 (0.079) | 4.5 (0.177) | 2.0 (0.079) | 4.5 (0.177) | 2.0 (0.079) | 4.5 (0.177) |
| | 300-420 | 3.0 (0.118) | 5.5 (0.217) | 3.0 (0.118) | 5.5 (0.217) | 3.0 (0.118) | 5.5 (0.217) | 3.0 (0.118) | 5.5 (0.217) |
| | 460-750 | 0 | 2.0 (0.079) | 0 | 2.0 (0.079) | 0 | 2.0 (0.079) | 0 | 2.0 (0.079) |
| e1 Tape & Reel and In-Line Lead | 115-420 | 0 | 2.0 (0.079) | 0 | 2.0 (0.079) | 0 | 2.0 (0.079) | 0 | 2.0 (0.079) |
| | 460-550* | 0 | 2.0 (0.079) | 0 | 2.0 (0.079) | 0 | 2.0 (0.079) | 0 | 2.0 (0.079) |
| e2 | ALL | n/a | n/a | n/a | n/a | 4.0 (0.138) | 6.0 (0.236) | 4.0 (0.157) | 6.0 (0.236) |
| e3 | ALL | n/a | n/a | n/a | n/a | 0 | 2.0 (0.079) | 0 | 2.0 (0.079) |
| E | 115-175 | -- | 9.0 (0.335) | -- | 9.0 (0.335) | -- | 9.0 (0.335) | -- | 9.0 (0.335) |
| | 200-275 | -- | 9.5 (0.374) | -- | 9.5 (0.374) | -- | 9.5 (0.374) | -- | 9.5 (0.374) |
| | 300-460 | -- | 11.0 (0.433) | -- | 11.0 (0.433) | -- | 11.0 (0.433) | -- | 11.0 (0.433) |
| | 510-575 | -- | 12.0 (0.472) | -- | 12.0 (0.472) | -- | 12.0 (0.472) | -- | 12.0 (0.472) |
| | 625-750 | -- | 13.0 (0.512) | -- | 13.0 (0.512) | -- | 13.0 (0.512) | -- | 13.0 (0.512) |
| L | ALL | 25.4 (1.00) | -- | 25.4 (1.00) | -- | 25.4 (1.00) | -- | 25.4 (1.00) | -- |
| L3 | ALL | n/a | n/a | n/a | n/a | 6.0 (0.236) | -- | 6.0 (0.236) | -- |
| Dia b | 115-420 | 0.76 (0.030) | 0.86 (0.034) | 0.76 (0.030) | 0.86 (0.034) | 0.76 (0.030) | 0.86 (0.034) | 0.76 (0.030) | 0.86 (0.034) |
| | 460-750 | 0.76 (0.030) | 0.86 (0.034) | 0.95 (0.037) | 1.05 (0.041) | 0.76 (0.030) | 0.86 (0.034) | 0.95 (0.037) | 1.05 (0.041) |
| Dia c Outside Lead Only | ALL | n/a | n/a | n/a | n/a | 0.76 (0.030) | 0.86 (0.034) | 0.76 (0.030) | 0.86 (0.034) |

NOTES:

* Tape and Reel packaging option is available only for devices up to 420Vrms.

Tape and Reel Specification

iTMOV[®] VARISTOR WITH INNER CRIMP



TMOV[®] VARISTOR WITH OUTER CRIMP



iTMOV[®] VARISTOR WITH STRAIGHT LEADS



TMOV[®] VARISTOR WITH STRAIGHT LEADS



| | DESCRIPTION | CRIMPED LEADS | | STRAIGHT LEADS | |
|----------------------|---|-----------------|-----------------|----------------------|----------------------|
| | | MODEL SIZE | | MODEL SIZE | |
| | | 14mm | 20mm | 14mm | 20mm |
| B₁ | Component Top to Seating Plane | 22.5 Max | 31 Max | 22.0 Max | 28.0 Max |
| P | Pitch of Component | 25.4 +/- 1.0 | 25.4 +/- 1.0 | 25.4 ±1.0 | 25.4 ±1.0 |
| P₀ | Feed Hole Pitch | 12.7 +/- 0.2 | 12.7 +/- 0.2 | 12.7 ±0.2 | 12.7 ±0.2 |
| P₁ | Feed Hole Center to Pitch | 8.95 +/- 0.7 | 8.95 +/- 0.7 | 8.95 ±0.7 | 8.95 ±0.7 |
| P₂ | Hole Center to Component Center | 12.7 +/- 0.7 | 12.7 +/- 0.7 | 12.7 ±0.7 | 12.7 ±0.7 |
| F | Lead to Lead Distance | 75 +/- 0.8 | 75 +/- 0.8 | 75 ±0.8 | 75 ±0.8 |
| Δh | Component Alignment | 2.0 Max | 2.0 Max | 2.0 Max | 2.0 Max |
| W | Tape Width | 18.0 +1.0/-0.5 | 18.0 +1.0/-0.5 | 18.0 +1.0/-0.5 | 18.0 +1.0/-0.5 |
| W₀ | Hold Down Tape Width | 12.0 +/- 0.3 | 12.0 +/- 0.3 | 12.0 ±0.3 | 12.0 ±0.3 |
| W₁ | Hole Position | 9.0 +0.75/-0.50 | 9.0 +0.75/-0.50 | 9.0 +0.75/-0.5 | 9.0 +0.75/-0.5 |
| W₂ | Hold Down Tape Position | 0.5 Max | 0.5 Max | 0.5 Max | 0.5 Max |
| H | Height from Tape Centre to Component Base (non-crimped parts) | – | – | 18.0 +2.0/0 | 18.0 +2.0/0 |
| H₀ | Seating Plane Height (crimped parts only) | 16.0 +/- 0.5 | 16.0 +/- 0.5 | – | – |
| H₁ | Component Height | 40.0 Max | 46.5 Max | 40.0 Max | 46.5 Max |
| C | Crimp Length (crimped parts only) | 2.6 typ | 2.6 typ | – | – |
| D₀ | Feed Hole Diameter | 4.0 +/- 0.2 | 4.0 +/- 0.2 | 4.0 ±0.2 | 4.0 ±0.2 |
| t | Total Tape Thickness | 0.7 +/- 0.2 | 0.7 +/- 0.2 | 0.7 ±0.2 | 0.7 ±0.2 |
| L | Length of Clipped Lead | 11.0 Max | 11.0 Max | 11.0 Max | 11.0 Max |
| Δp | Component Alignment | 3 Max, 1.00mm | 3 Max | 3 deg Max, 1.0mm Max | 3 deg Max, 1.0mm Max |

NOTES:

- Dimensions in mm
- Reel capacity varies with voltage.
- Leads are crimped and in-line. This excludes the monitor lead on iTMOV[®] varistor which are not crimped and not in-line.
- To order tape and reel option please add suffix 'L2T7' to end of standard part number.
- Tape and reel option is available for rated voltages up to 420V. Contact factory regarding availability of higher voltages.
- Contact Littelfuse for additional details.

Part Numbering System

Base Part Codes
(See ratings & specifications tables and notes below)



Option Codes¹
(See below)

XXXXX
NON-STANDARD LEAD FORM, PACKAGING and LEAD SPACING OPTIONS¹:

- L2B7: Lead Form: Crimped and In-Line² Leads
Packaging: Bulk Pack
Lead Spacing³: 7.5mm
- L2T7: Lead Form: Crimped and In-Line² Leads
Packaging: Tape and Reel⁴
Lead Spacing³: 7.5mm
- L3T7: Lead Form: Straight Leads and In-Line² Leads
Packaging: Tape and Reel
Lead Spacing³: 7.5mm

Option Codes:
X2855: Nickel Barrier coated wire option –
All standard parts use tinned copper clad steel wire. Nickel Barrier coated wire is available as an option, consisting of Copper wire with a flashing of Nickel followed by a top coating of Tin. To order append standard model BASE PART number with "X2855." Example:

| Standard Model | Order As |
|----------------|-------------------|
| TMOV20RP115E | TMOV20RP115EX2855 |

Other non-standard options may be available - please contact Littelfuse.

NOTES:

- 1 Use Base Part Code only to receive standard product:
Lead Form: Straight Leads. Devices greater than 420Vrms are provided In-Line².
Packaging: Bulk Pack
Lead Spacing: 7.5mm +/-1.0mm
- 2 "In-Line" refers to straight row of leads at the tip where product is to contact the circuit board. Refer to "e1" in Device Dimensions section.
- 3 Lead Spacing refers to span between leads as "e" dimension in Device Dimensions section.
- 4 Due to device bulk, tape and reel packaging option is available only for devices up to 420Vrms.

Pack Quantities

| Rated Voltage | Pack Quantities | | | |
|---------------|-----------------|------|---------------|------|
| | Bulk Pack | | Tape and Reel | |
| | Model Size | | Model Size | |
| | 14mm | 20mm | 14mm | 20mm |
| 115-250 | 600 | 400 | 500 | 400 |
| 275-550 | 500 | 300 | 400 | 300 |
| 575-750 | 400 | 200 | n/a | n/a |

NOTE: Tape and Reel available up to 420V only - please contact factory regarding availability of higher voltage parts.

Компания «Океан Электроники» предлагает заключение долгосрочных отношений при поставках импортных электронных компонентов на взаимовыгодных условиях!

Наши преимущества:

- Поставка оригинальных импортных электронных компонентов напрямую с производств Америки, Европы и Азии, а так же с крупнейших складов мира;
- Широкая линейка поставок активных и пассивных импортных электронных компонентов (более 30 млн. наименований);
- Поставка сложных, дефицитных, либо снятых с производства позиций;
- Оперативные сроки поставки под заказ (от 5 рабочих дней);
- Экспресс доставка в любую точку России;
- Помощь Конструкторского Отдела и консультации квалифицированных инженеров;
- Техническая поддержка проекта, помощь в подборе аналогов, поставка прототипов;
- Поставка электронных компонентов под контролем ВП;
- Система менеджмента качества сертифицирована по Международному стандарту ISO 9001;
- При необходимости вся продукция военного и аэрокосмического назначения проходит испытания и сертификацию в лаборатории (по согласованию с заказчиком);
- Поставка специализированных компонентов военного и аэрокосмического уровня качества (Xilinx, Altera, Analog Devices, Intersil, Interpoint, Microsemi, Actel, Aeroflex, Peregrine, VPT, Syfer, Eurofarad, Texas Instruments, MS Kennedy, Miteq, Cobham, E2V, MA-COM, Hittite, Mini-Circuits, General Dynamics и др.);

Компания «Океан Электроники» является официальным дистрибьютором и эксклюзивным представителем в России одного из крупнейших производителей разъемов военного и аэрокосмического назначения «JONHON», а так же официальным дистрибьютором и эксклюзивным представителем в России производителя высокотехнологичных и надежных решений для передачи СВЧ сигналов «FORSTAR».



JONHON

«JONHON» (основан в 1970 г.)

Разъемы специального, военного и аэрокосмического назначения:

(Применяются в военной, авиационной, аэрокосмической, морской, железнодорожной, горно- и нефтедобывающей отраслях промышленности)

«FORSTAR» (основан в 1998 г.)

ВЧ соединители, коаксиальные кабели, кабельные сборки и микроволновые компоненты:

(Применяются в телекоммуникациях гражданского и специального назначения, в средствах связи, РЛС, а так же военной, авиационной и аэрокосмической отраслях промышленности).



Телефон: 8 (812) 309-75-97 (многоканальный)

Факс: 8 (812) 320-03-32

Электронная почта: ocean@oceanchips.ru

Web: <http://oceanchips.ru/>

Адрес: 198099, г. Санкт-Петербург, ул. Калинина, д. 2, корп. 4, лит. А